

**YAMAHA**

---

*Virtual Acoustic Synthesizer*

**VL1**

---

**Getting Started**

# VLI

*Virtual Acoustic Synthesizer*



*Getting Started*

**Owner's Manual 1**

# Contents



Precautions .....	4
<b>About the Manuals .....</b>	<b>6</b>
■ The Getting Started Manual (this manual) .....	6
■ The Feature Reference Manual .....	7
■ Conventions .....	7
<b>VL1 Basics .....</b>	<b>8</b>
<b>Essential Concepts for the VL1 User</b>	
■ What Are the Advantages? .....	9
■ The VL1 Model .....	10
The Instrument .....	10
The Controllers .....	12
The Modifiers .....	13
■ There's More ... ..	15
<b>The Controls &amp; Connectors .....</b>	<b>16</b>
<b>A Brief Introduction To the VL1 Interface</b>	
■ Front Panel .....	17
■ Rear Panel .....	20
<b>Setting Up .....</b>	<b>22</b>
<b>System Connections &amp; Preparation</b>	
■ Power Supply .....	22
■ Controllers .....	23
Breath Controller .....	23
Foot Controllers .....	23
Foot Switches .....	23
■ Audio Connections .....	23
Headphones .....	23
Stereo Sound System .....	24
■ MIDI Connections .....	24
■ Power-on Procedure .....	25
■ Play the Demo .....	26
■ Breath Controller Calibration .....	29
■ Load the Pre-programmed Voice Data .....	31





---

## **Voice Selection . . . . . 34**

### Selecting & Playing the VL1's 128 Voices

---

- Using the Voice Directory . . . . . 36
- The Pre-programmed VL1 Voices . . . . . 37

---

## **The Controllers . . . . . 38**

### Natural Musical Nuance and Expressive Control

---

- Physical Controllers . . . . . 39
- VL1 Controller Parameters . . . . . 40
- Controller Views . . . . . 41
- Some Exercises With the AltoSax Controllers . . . . . 42
- Controller Envelopes . . . . . 46
- Other Controller Views . . . . . 47

---

## **Mixing & The Modifiers . . . . . 48**

### Creating New Timbres and Original Voices

---

- Mixing . . . . . 48**
  - An Exercise: Remix the Pan Pipes Voice . . . . . 49
- The Modifiers . . . . . 51**
  - Harmonic Enhancer . . . . . 51
  - Dynamic Filter . . . . . 54
  - Frequency Equalizer . . . . . 55
  - Impulse Expander . . . . . 56
  - Resonator . . . . . 57

---

## **Effects . . . . . 58**

### Creating the Right Ambience

---

- Modulation Effects . . . . . 59
- Feedback Delay Effects . . . . . 59
- Reverb Effects . . . . . 60

---

## **Index . . . . . 62**

---



# Precautions

*!! PLEASE READ THIS BEFORE PROCEEDING !!*

## ■ Location

Do not expose the instrument to the following conditions to avoid deformation, discoloration, or more serious damage.

- Direct sunlight (e.g. near a window).
- High temperatures (e.g. near a heat source, outside, or in a car during the daytime).
- Excessive humidity.
- Excessive dust.
- Strong vibration.

## ■ Power Supply

- Turn the power switch OFF when the instrument is not in use.
- The power supply cord should be unplugged from the AC outlet if the instrument is not to be used for an extended period of time.
- Unplug the instrument during electric storms.
- Avoid plugging the instrument into the same AC outlet as appliances with high power consumption, such as electric heaters or ovens. Also avoid using multi-plug adaptors since these can result in reduced sound quality and possibly damage.

## ■ Turn Power OFF When Making Connections

- To avoid damage to the instrument and other devices to which it is connected (a sound system, for example), turn the power switches of all related devices OFF prior to connecting or disconnecting audio and MIDI cables.

## ■ MIDI Connections

- When connecting the VL1 to MIDI equipment, be sure to use high-quality cables made especially for MIDI data transmission.
- Avoid MIDI cables longer than about 15 meters. Longer cables can pick up electrical noise that can cause data errors.

## ■ Handling and Transport

- Never apply excessive force to the controls, connectors or other parts of the instrument.
- Always unplug cables by gripping the plug firmly, not by pulling on the cable.
- Disconnect all cables before moving the instrument.
- Physical shocks caused by dropping, bumping, or placing heavy objects on the instrument can result in scratches and more serious damage.

## ■ Cleaning

- Clean the cabinet and panel with a dry soft cloth.
- A slightly damp cloth may be used to remove stubborn grime and dirt.
- Never use cleaners such as alcohol or thinner.
- Avoid placing vinyl objects on top of the instrument (vinyl can stick to and discolor the surface).

## ■ Electrical Interference

- This instrument contains digital circuitry and may cause interference if placed too close to radio or television receivers. If this occurs, move the instrument further away from the affected equipment.

## ■ Data Backup

- The VL1 contains a special long-life battery that retains the contents of its internal memory even when the power is turned OFF. The backup battery should last for several years. When the backup battery needs to be replaced “Change battery!” will appear on the display when the power is turned on. When this happens, have the backup battery replaced by qualified Yamaha service personnel. **DO NOT ATTEMPT TO REPLACE THE BACKUP BATTERY YOURSELF!**



- Internal memory data can be corrupted due to incorrect operation. Be sure to save important data to floppy disk frequently so you have a backup to revert to if something happens to damage the data in memory. Also note that magnetic fields can damage data on the disk, so it is advisable to make a second back-up copy of disks that contain very important data, and keep backup disks in a safe place away from stray magnetic fields (i.e. away from speakers, appliances containing motors, etc.).

### ■ Handle Floppy Disks and the Disk Drive With Care

- Use only 3.5" 2HD or 2DD type floppy disks.
- Do not bend or apply pressure to the floppy disk. Do not open the shutter and touch the surface of the floppy disk inside.
- Do not expose the disk to high temperatures. (e.g. direct sunlight)
- Do not expose the disk to magnetic fields. Magnetic fields can partially or totally erase data on the disk, rendering the disk unreadable.
- To eject a floppy disk, press the eject button slowly as far as it will go then, when the disk is fully ejected, remove it by hand.  
The disk may not be ejected properly if the eject button is pressed too quickly, or it is not pressed in as far as it will go (the eject button may become stuck in a half-pressed position and the disk extends from the drive slot by only a few millimeters). If this happens, do not attempt to pull out the partially ejected disk. Using force in this situation can damage the disk-drive mechanism or the floppy disk. To remove a partially ejected disk, try pressing the eject button once again, or push the disk back into the slot and then repeat the eject procedure carefully.
- Do not insert anything but floppy disks into the disk drive. Other objects may cause damage to the disk drive or the floppy disk.

### ■ Service and Modification

- The VL1 contains no user serviceable parts. Opening it or tampering with it in any way can lead to irreparable damage and possibly electric shock. Refer all servicing to qualified YAMAHA personnel.

### ■ Third-party Software

- Yamaha can not take any responsibility for software produced for this product by third-party manufacturers. Please direct any questions or comments about such software to the manufacturer or their agents.

**YAMAHA is not responsible for damage caused by improper handling or operation.**



# About the Manuals



The VL1 comes with two manuals — *Getting Started* and *Feature Reference*.

## *The Getting Started Manual (this manual)*

---

The *Getting Started* manual contains seven chapters that take you through essential information and procedures you will need to know to become familiar with your VL1:

**1. VL1 Basics** [≥ Page 8]

Basic concepts you'll need to understand in order to get the most out of the VL1.

**2. The Controls & Connectors** [≥ Page 16]

Brief descriptions of the VL1 controls and connectors, and their functions.

**3. Setting Up** [≥ Page 22]

System connections, powering up, playing the demo, calibrating the Breath Controller, and loading the pre-programmed voices.

**4. Voice Selection** [≥ Page 34]

Several ways to select and play the VL1's 128 voices.

**5. The Controllers** [≥ Page 38]

The VL1 controllers and how they can be assigned and edited for optimum control.

**6. Mixing & The Modifiers** [≥ Page 48]

Customizing the sound to suit your own personal needs.

**7. Effects** [≥ Page 58]

An overview of the built-in digital effects that you can use to add depth and ambience to the VL1 sound.

We recommend that you go through the chapters in sequence and actually try out the various operations described. Once you've gone through the entire *Getting Started* manual in this way, you should be familiar enough with the VL1 to need only the VL1 *Feature Reference* manual in future.

## *The Feature Reference Manual*

---

The Feature Reference manual is the “nuts and bolts” reference for the VL1, individually describing its many functions in detail. The Feature Reference manual is divided into five main sections, each describing the various functions within a particular VL1 edit or utility mode.

- |  |
|--|
| <ol style="list-style-type: none"><li>1. <b>General Operation</b> [≥ Page 7]</li><li>2. <b>Play Mode</b> [≥ Page 13]</li><li>3. <b>Edit Mode</b> [≥ Page 21]</li><li>4. <b>Utility Mode</b> [≥ Page 151]</li><li>5. <b>Appendix</b> [≥ Page 177]</li></ol> |
|--|

Once you have become familiar with the way the VL1 works by going through the Getting Started manual, you should only need to refer to the Feature Reference manual from time to time to get details on functions you’ve never used before, or refresh your memory about functions that you don’t use very often.

Each section of the Feature Reference manual has its own table of contents, so you should be able to locate any particular function quickly and easily. Functions and references can also be located by referring to the index at the back of the manual.

## *Conventions*

---

The following conventions are used through the VL1 manuals to avoid confusion and make the text easier to read.

### **Buttons & Controls**

Button and control names used on the VL1 panel appear in the text in capital letters within a border: “the `ENTER` button”, for example.

### **Parameter Names**

Parameter names and other labels which appear on the VL1 display are printed in the `courier` typeface for easier identification: for example, “adjust the “Balance” parameter as required”.

### **Parameter Ranges**

An ellipsis is used to indicate a range of parameter values: e.g. “0 ... 127”. This minimizes the confusion sometimes caused by the use of a hyphen or dash for this purpose.





# VL1 Basics

*Essential Concepts for the VL1 User*



The Yamaha VL1 Virtual Acoustic Synthesizer produces sound in an entirely new way. It has no oscillators or function generators, no preset waveforms or samples. In fact, it uses *none* of the sound generation concepts employed in conventional synthesizers. The VL1 represents the world's first practical application of computer-based “physical modeling” in musical sound synthesis.

In the same way that computer models are used to simulate weather systems or the flight characteristics of aircraft in the design stage, the VL1 simulates the very complex vibrations, resonances, reflections and other acoustic phenomena that occur in a real wind or string instrument. This requires a tremendous amount of computer processing power (weather and aerodynamic modeling require room-filling super computers), and radical advances in microprocessor speed and capability plus some very sophisticated Yamaha technology were necessary to achieve the real-time sound generation capabilities exhibited by the ground-breaking VL1 Virtual Acoustic Synthesizer.

Orlando Lasso. a 6. XXXIIII. Basso.

Anto e quel. Dal vivo fonte de la tua bontate, ch'ogni gente arricchisce in ogni etate,



## *What Are the Advantages?*



**T**he VL1 offers many advantages in terms of musical performance. Not just in terms of sound, but also in terms of the “behavior” that makes acoustic instruments so ... well, musical! But this is not because someone has programmed a certain sound or pattern of behavior into it. The physical model can be programmed to have certain attributes — the length of a pipe or the stiffness of a reed, for example — but the actual sound produced by any configuration can only be accurately determined by playing it. Of course, the same applies to the design of acoustic instruments. Because of its natural acoustic behavior the VL1 is undoubtedly a little harder to play than conventional synthesizers, but when mastered this is the very characteristic that is its greatest strength. The Yamaha VL1 is the most *musical* synthesizer ever made. A soloist’s dream!

- The VL1 sounds better, has more depth, and is more realistic in the musical sense than any other synthesizer system.
- Simply pressing a key in the same way does not always produce precisely the same sound. The instrument is responsive and “alive”.
- Note-to-note transitions have the same continuity exhibited by acoustic instruments. What goes on in between the notes is just as important musically as the notes themselves.
- It has extraordinary expressive capability. Rather than simply controlling parameters like volume or pitch, you can control characteristics such as breath and reed pressure with appropriate complex effects on the timbre of the sound.



## The VL1 Model



The overall VL1 model or “algorithm” consists of three main blocks: the instrument, controllers, and modifiers. In schematic form these blocks are arranged as follows:

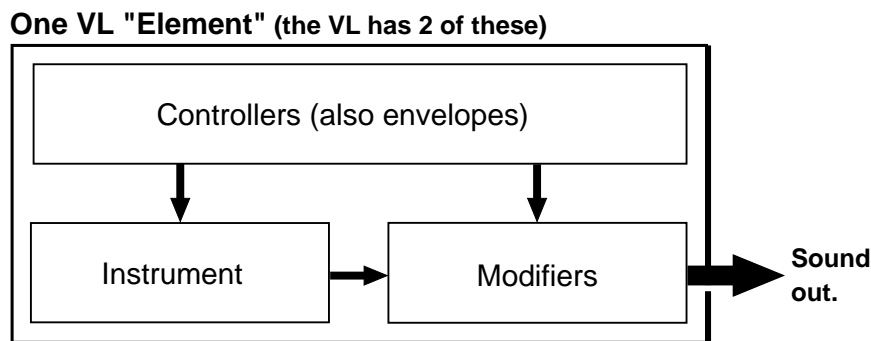

### ● The Instrument

The key block in this algorithm is the *instrument*, since it is here that the fundamental tone or “timbre” of the sound is defined. The extreme complexity of this portion of the model makes it unsuitable for user programming, so various instruments for the VL1 are provided in the form of pre-programmed voices. These are primarily woodwind, brass, and string voices, since the VL1’s physical model is capable of most accurately simulating the sound-generating mechanism of all three instrument categories.

The instrument model consists primarily of a *driver* — the reed/mouthpiece, lip/mouthpiece, or bow/string system — and a resonant system corresponding to the tube and air column or string.



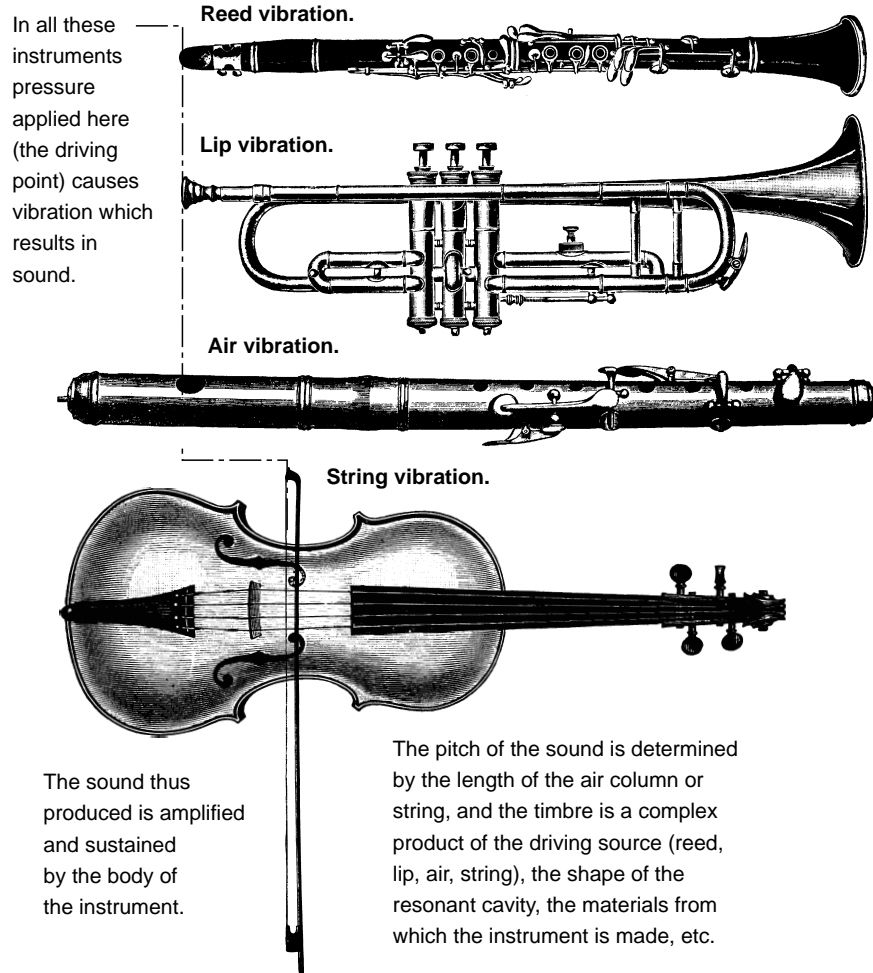

One of the remarkable features of the VL1's Virtual Acoustic Synthesis system is that just about any driver can be used with any type of pipe or string.

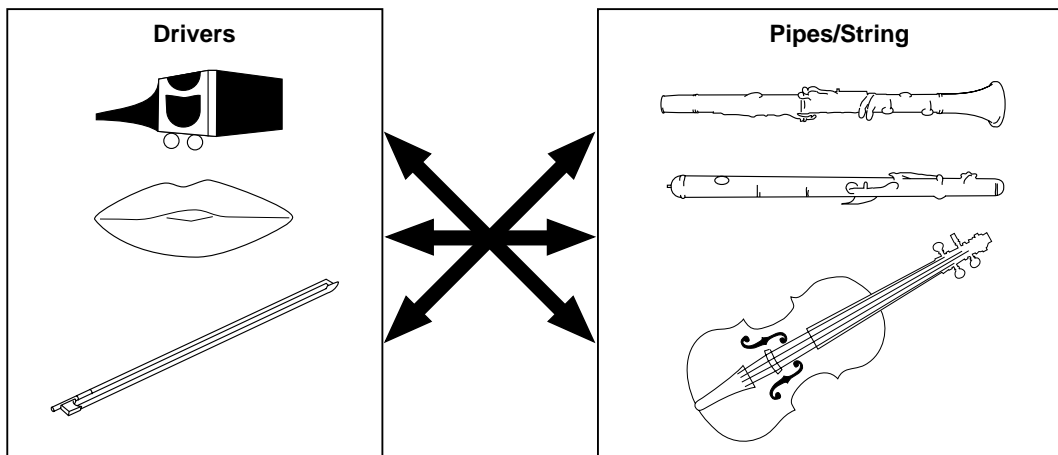

## ● The Controllers

The input to an acoustic instrument comes from the player's lungs, trachea, oral cavity, and lips. In a string instrument it comes from the player's arm movement, transmitted to the string via a bow. These elements actually form an important part of the sound generating system and, in the VL1 model, are included in the controllers block. The player also influences the sound of the instrument by playing the keys, tone holes, or frets, and this aspect of control constitutes another part of the controllers block. These and other control parameters provided by the VL1 are listed in the illustration below.

In essence, the controller parameters determine how the instrument "plays". All of these parameters can be assigned to any of the external controllers that can be used with the VL1: breath controller, foot controller, modulation wheels, etc. The *pressure* parameter, for example, will normally be assigned to a breath controller so the player can control the dynamics of the instrument by varying the breath pressure applied to the controller — a natural, instinctive way to play wind-instrument voices. At the same time the *growl* and *throat* parameters might also be assigned to the breath controller in order to achieve life-like response and effects.

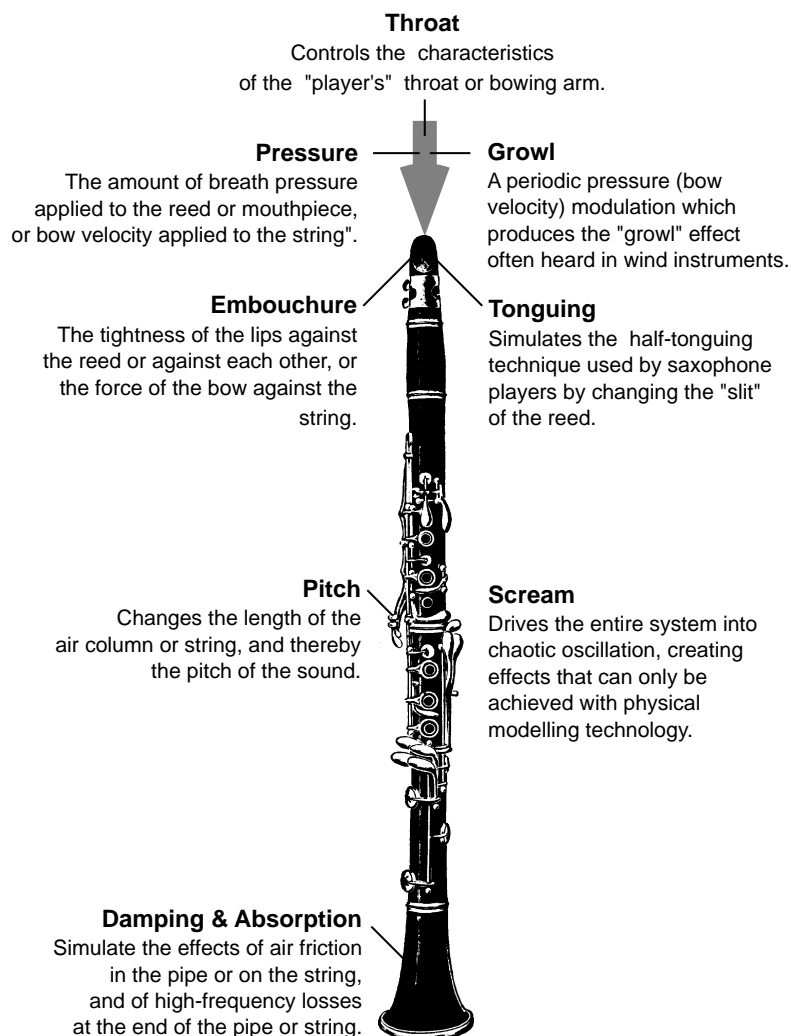

## ● The Modifiers

Although you don't have direct programming access to the VL1 instrument block, the *modifiers* allow a significant degree of control over the final timbre of the voice. The modifiers block consists of 5 sections as shown in the diagram. Although these may appear to be simple effects, they are actually intimately related to the VL1's sound-producing model and have a significant effect on the sound (the VL1 has a separate effects stage with reverb, delay, and modulations effects — see page 58).

### **Harmonic Enhancer**

The Harmonic Enhancer allows you to manipulate the harmonic structure of the sound to the extent that you can create radical timbral variations within the current instrument “family” (e.g. saxes). [Page 51]

### **Dynamic Filter**

This section is similar to the dynamic filters found in many conventional synthesizers. It has selectable high-pass, bandpass, band elimination, and low-pass modes, and a “wet/dry” balance parameter which allows delicate variations in the degree of filtration applied. Another important feature is keyboard cutoff tracking which varies the cutoff frequency according to the key played. [Page 54]

### **Frequency Equalizer**

This is a 5-band parametric equalizer with frequency, Q (bandwidth), and level control. The equalizer also has pre-EQ high- and low-pass filters as well as key scaling capability for precise response control throughout the instrument's range. [Page 55]

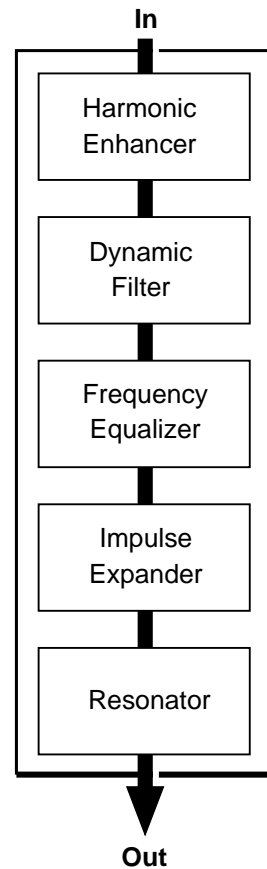

### **Impulse Expander**

The Impulse Expander works in conjunction with the Resonator, described below, to simulate the effect of an instrument's resonant cavity or sound box. It can also be used to simulate the acoustic environment in which the instrument is played. In contrast to the Resonator, the Impulse Expander is more suited to the simulation of metallic resonances and is thus invaluable for refining the sound of brass and metal-bodied woodwinds. Other important effects are the ability to diffuse sharp attack sounds and to give depth and realism to vibrato. *[Page 56]*

### **Resonator**

While the Impulse Expander and even the Harmonic Enhancer tend to give the sound a metallic quality, the Resonator produces a more woody resonance effect. Careful adjustment of the resonator's parameters can often bring a not-quite-right voice to life. *[Page 57]*

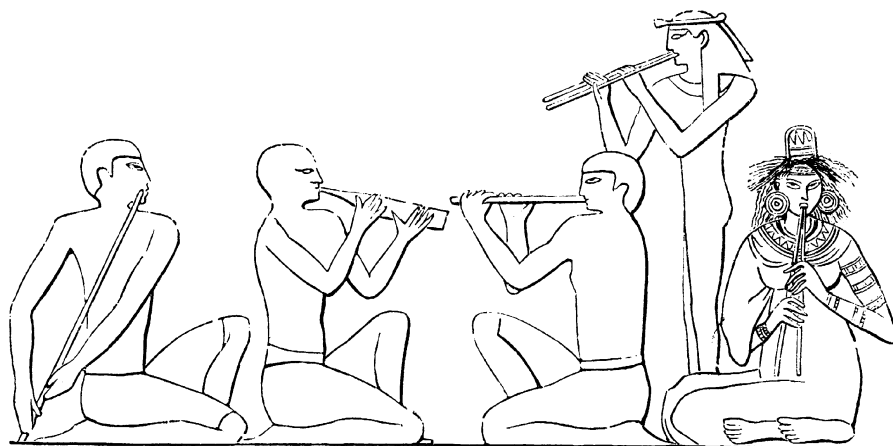

## There's More ...



In this brief introduction to VL1 basics we've only looked at the central physical model which is the key to the VL1's unprecedented sound and musical performance. There's actually much more to it. To begin with the VL1 actually has *two elements* which function as independent physical models. Although it is basically a monophonic solo instrument, this means that the VL1 *can* produce two notes at once. More commonly the two elements are used as *layers* of a single voice.

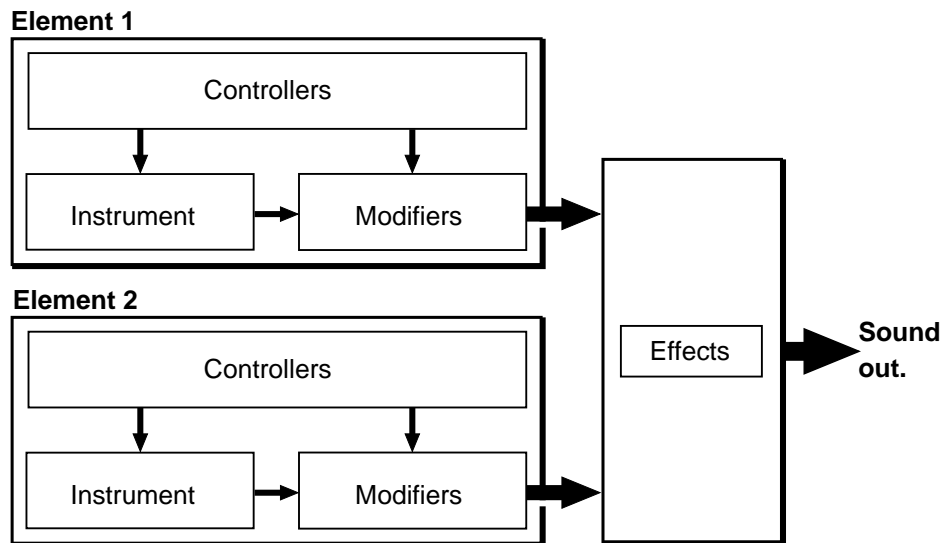

There's also an extensive range of other functions and features that are similar to those you may be familiar with from conventional synthesizers. There are, for example, a range of programmable envelopes that can be applied to most of the controllers in addition to real-time player control. And, of course, there's a comprehensive selection of MIDI, disk, and other utility functions that give the VL1 maximum versatility and convenience.

Now that you understand the basics, dive in and find out what the VL1 can really do.





# The Controls & Connectors

*A Brief Introduction To the VL1 Interface*



The following brief descriptions of the VL1 controls and connectors should help you to understand the overall logic of the interface.

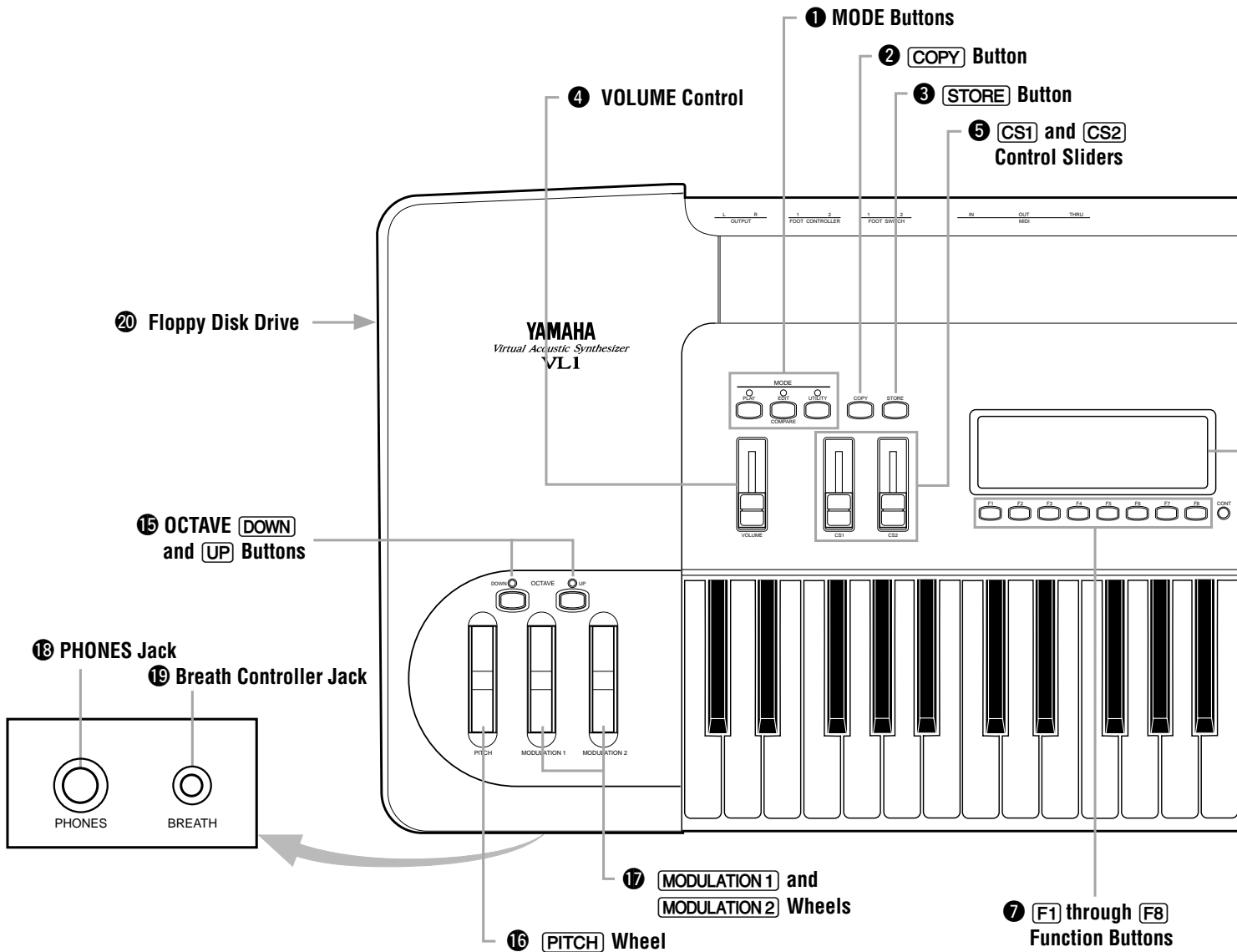

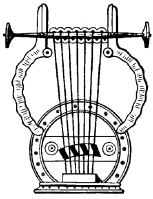

## Front Panel

### 1 MODE Buttons

The **PLAY**, **EDIT**, and **UTILITY** buttons select the corresponding VL1 modes. The PLAY mode lets you select and play voices, the EDIT mode gives you programming access to the VL1's voice and controller parameters, and the UTILITY mode includes MIDI, disk, system and other functions that are essential for general operation.

### 2 COPY Button

This button is used to copy voice parameters for fast, efficient editing.

☛ Feature Reference page 25.

### 3 STORE Button

Used to store edited data to an internal memory location.

☛ Feature Reference page 28.

### 6 LCD Display & CONT Control

### 8 Data Dial

### 10 DEC and INC Buttons

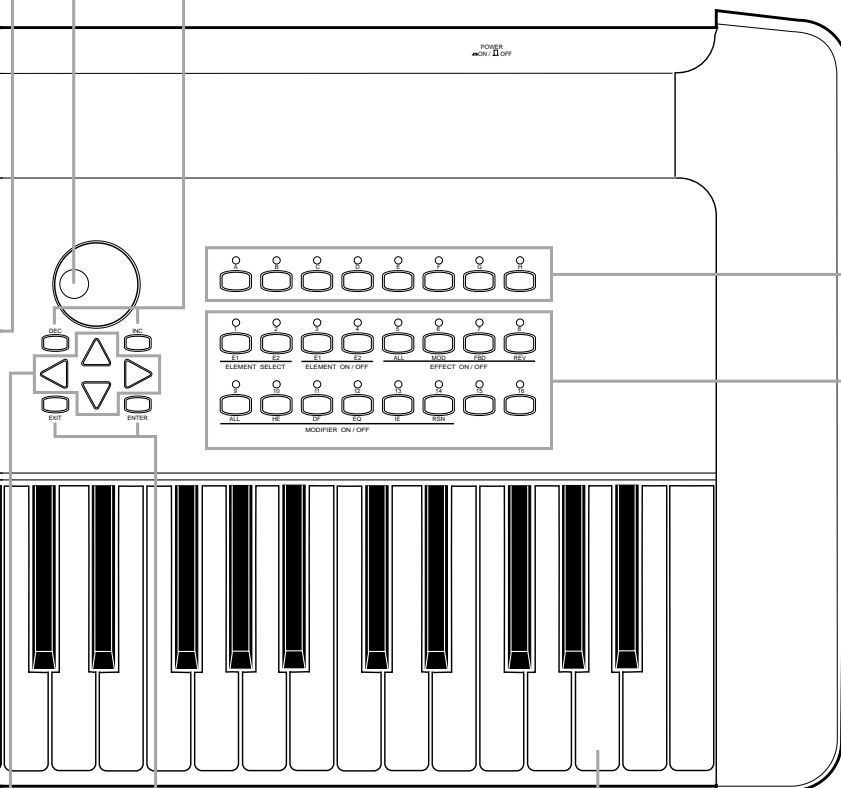

### 12 Bank A through H Buttons

### 13 Voice Number 1 through 16 Buttons

### 11 EXIT and ENTER Buttons

### 14 Keyboard

### 9 Cursor Buttons

#### **4 VOLUME Control**

Adjusts the volume of the sound delivered via the rear-panel OUTPUT L and R jacks as well as the PHONES jack.

☛ *Getting Started* page 25.

#### **5 **CS1** and **≠** Control Sliders**

These controls can be assigned to a range of controller parameters for real-time expressive control.

☛ *Getting Started* page 47. *Feature Reference* page 19.

#### **6 LCD Display & **÷** Control**

This large multi-function liquid crystal display panel shows all parameters and prompts you need to operate the VL1 with optimum ease and efficiency.

Use the **÷** (contrast) control located near the lower right-hand corner of the display to achieve the best display visibility (LCD visibility varies greatly with viewing angle and lighting).

☛ *Getting Started* page 34. *Feature Reference* page 14.

#### **7 **F1** through **F8** Function Buttons**

The functions of these buttons depend on the selected mode. They are used to engage a function indicated on the display immediately above the button, select a page of parameters, scroll through a list of parameters, and more.

☛ *Getting Started* page 26. *Feature Reference* page 9.

#### **8 Data Dial**

The data entry dial provides a fast, efficient way to cover a broad range of voice numbers when, for example, you're looking for a voice but don't know the voice number. It's also handy for making large value changes in any of the edit modes.

The data dial is "speed sensitive", allowing accurate single step selection when rotated slowly as well as large value "jumps" when rotated quickly.

☛ *Getting Started* page 35. *Feature Reference* page 16.

#### **9 Cursor Buttons**

These 4 buttons move the "cursor" around the display screen, highlighting the various items that are available for selection or parameters that are available for editing (the VL1 cursor appears as a dark block with inverse characters).

☛ *Getting Started* page 32. *Feature Reference* page 10.

#### **10 **DEC** and **INC** Buttons**

Used to select voices and edit parameter values in any of the VL1 edit modes. Either button can be pressed briefly for single stepping in the specified direction, or held for continuous scrolling. These buttons are also used to respond "Yes" or "No" to the "Are you sure?" confirmation prompt when saving, loading data.

☛ *Getting Started* page 35. *Feature Reference* page 16.

#### **11 **EXIT** and **ENTER** Buttons**

The **EXIT** button can generally be used to exit from any sub-mode or function, while the **ENTER** button is used to engage a variety of modes and functions.

☛ *Getting Started* page 27. *Feature Reference* page 10.



**12 Bank [A] through [H] Buttons**

The VL1 has 128 internal voice memory locations arranged in 8 banks of 16 voices each. These buttons select the voice bank from which an individual voice will be selected.

☛ *Getting Started* page 35. *Feature Reference* page 15.

**13 Voice Number [1] through [16] Buttons**

The voice number buttons are used in conjunction with the bank buttons to select any of the VL1's 128 internal voice memory locations. When editing voice parameters they are also used to select and mute elements, an to turn effects and modifiers on or off.

☛ *Getting Started* page 35. *Feature Reference* page 15.

**14 Keyboard**

The VL1 has a 49-key keyboard that is both velocity and after-touch sensitive for broad, intimate expressive control.

**15 OCTAVE [DOWN] and [UP] Buttons**

Shift the pitch of the keyboard up or down one octave. A utility "Octave Hold" function (page 153 of the Feature Reference manual) provides two modes: shift only while the button is held, or press once to shift and again to release. MIDI note output data is also shifted.

**16  $\pi$  Wheel**

This self-centering pitch wheel allows realistic upward and downward pitch bends.

**17 [MODULATION1] and [MODULATION2] Wheels**

Can be assigned to any of the VL1's extensive range of controller parameters for extraordinary expressive control.

☛ *Getting Started* page 41.

**18 PHONES Jack**

Accepts a standard pair of stereo headphones (1/4" stereo phone plug) for headphone monitoring of the VL1 sound without the need for external amplification equipment.

☛ *Getting Started* page 23.

**19 Breath Controller Jack**

Plug the Yamaha BC2 Breath Controller supplied with the VL1 in here (an optional BC1 Breath Controller may also be used).

☛ *Getting Started* page 23.

**20 Floppy Disk Drive**

The VL1's built-in floppy disk drive allows easy, economical, high-volume storage of voice data. The disk-in-use indicator below the drive slot lights while any disk operation is in progress (NEVER attempt to remove a disk or turn the power off while a disk operation is in progress). The eject button, also below the disk slot, is used to remove disks from the drive.

☛ *Feature Reference* page 162.

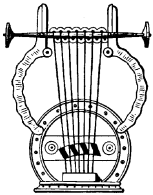
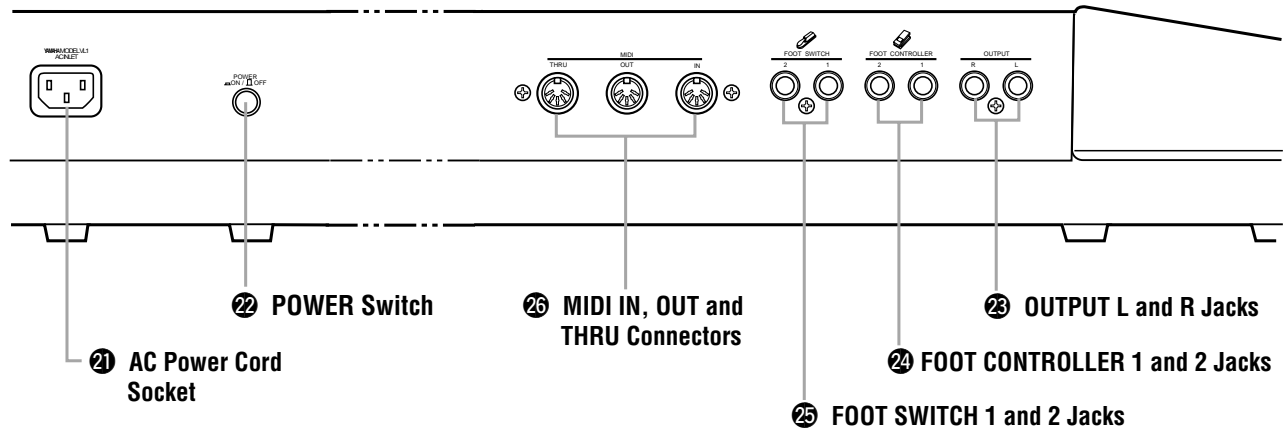

## Rear Panel

### 21 AC Power Cord Socket

Be sure to plug the VL1's AC power cord into this socket before plugging the power cord into an AC outlet.

☛ *Getting Started* page 22.

### 22 POWER Switch

Press to turn power ON or OFF.

### 23 OUTPUT L and R Jacks

These are the main stereo outputs from the VL1. Be sure to connect both outputs to the appropriate channels of a stereo sound system in order to appreciate the full quality of the VL1 sound and effects.

☛ *Getting Started* page 24.

### 24 FOOT CONTROLLER 1 and 2 Jacks

These jacks accept Yamaha FC7 Foot Controllers which can be used to control any of the VL1's controller parameters. One FC7 Foot Controller is supplied with the VL1, and this should normally be plugged into the FOOT CONTROLLER 2 jack. The second FC7 foot controller is optional.

☛ *Getting Started* page 23.

### 25 FOOT SWITCH 1 and 2 Jacks

An optional Yamaha FC4 or FC5 footswitch can be connected to one or both of these jacks for sustain, portamento, and other control functions.

☛ *Getting Started* page 23.

### 26 MIDI IN, OUT and THRU Connectors

The MIDI IN connector receives the data from an external sequencer or other MIDI device which is to control or transmit data to the VL1. The MIDI THRU connector simply re-transmits the data received at the MIDI IN connector, allowing convenient chaining of MIDI devices. The MIDI OUT connector transmits data corresponding to all VL1 performance operations, or bulk data when one of the MIDI data transmission functions are activated.

☛ *Getting Started* page 24.





# Setting Up

System Connections & Preparation

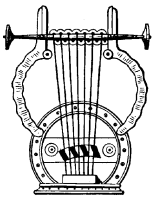
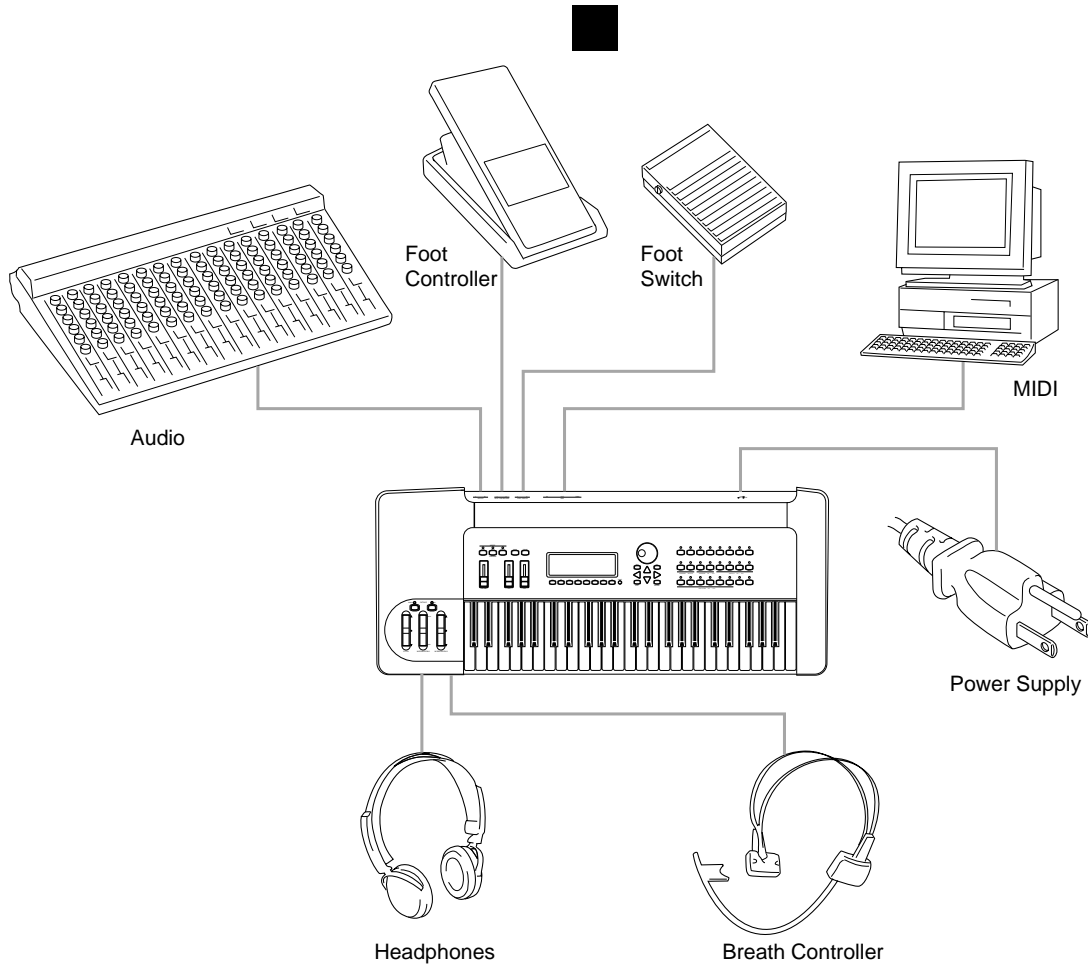

## Power Supply

Before making any other connections the “female” end of the AC power cord supplied with the VL1 should be firmly plugged into the rear-panel AC cord socket. Ideally the power cord should then be plugged into a convenient AC outlet after you’ve made all other necessary connections and placed the VL1 in the position in which it will be used. Always make sure that the POWER switch is in the OFF (extended) position before plugging the power cord in an AC outlet.



**CAUTION!** ■ Make sure your VL1 is rated for the AC voltage supplied in the area in which it is to be used (as listed on the rear panel). Connecting the VL1 to the wrong AC supply can cause serious damage to the internal circuitry and may even pose a shock hazard!

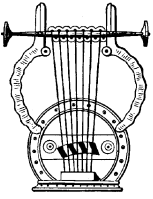

## Controllers

### ● Breath Controller

The Breath Controller is an essential expressive tool — both for realistic expression with wind-instrument voices and unprecedented expressive control with string voices. Plug the BC2 Breath Controller supplied with the VL1 (or an optional BC1 breath controller) into the front-panel breath controller jack. The Breath Controller is ideal for controlling parameters that would normally be affected by a wind player's breath: dynamics, timbre, pitch, and others.

Once you've set up your system and begin playing, refer to "Breath Controller Calibration" on page 29 for instructions on calibrating your Breath Controller for optimum control precision and ease.

**NOTES ■** For more information on Breath Controller setup and operation, see the instructions packed with the supplied BC2 Breath Controller.

### ● Foot Controllers

Although the VL1 has jacks for two foot controllers, it is not necessary to use both. To begin with plug the supplied FC7 Foot Controller into the rear-panel FOOT CONTROLLER 2 jack.

If you purchase a second FC7 Foot Controller for extra control capability, plug it into the FOOT CONTROLLER 1 jack.

**NOTES ■** For more information on Foot Controller setup and operation, see the instructions packed with the supplied FC7 Foot Controller.

### ● Foot Switches

The use of one or two footswitches allows sustain, portamento, and mono/poly mode switching. We recommend that you purchase at least one Yamaha FC4 or FC5 Footswitch for this purpose. A single footswitch can be plugged into either the rear-panel FOOTSWITCH 1 or 2 jack.

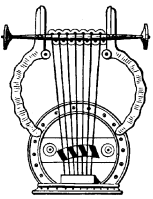

## Audio Connections

### ● Headphones

For private listening and practice headphones are ideal. You don't have to hook up and complete sound system, and you won't disturb the neighbors no matter how loud or late you play. Recommended Yamaha headphones for VL1 monitoring are the HPE-170, HPE-160, or HPE-150 Stereo Headphones. Any standard pair of stereo headphones with a 1/4" stereo phone plug and an impedance of between about 8 and 150 ohms can be used.



## ● Stereo Sound System

The VL1 voices and effects are designed to sound their best in stereo, so you should always use a stereo sound system to appreciate the full impact of the VL1 voices and expressive features. The VL1 OUTPUT L and R jacks can be connected directly to musical instrument amplifiers designed for keyboard use, or to the line inputs of a mixing console. It is also possible to connect the VL1 outputs directly to the inputs of a multitrack or stereo tape recorder.

**NOTES** ■ *If you need to drive a mono amp or other device the VL1 output can be switched to mono — the same signal appears at the L and R outputs — by using the Output parameter described on page 154 of the Feature Reference manual.*

■ *Make sure that both the VL1 and your sound system are turned OFF when making connections.*

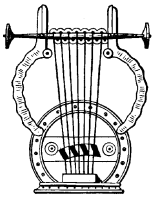

## MIDI Connections

Like any other MIDI instrument the VL1 can be used with MIDI tone generators, sequencers, computer software, and controllers for virtually unlimited system expansion and control capability. You might, for example, like to control it from a Yamaha wind controller such as the WX11 rather than the keyboard for even more realistic wind-instrument feel and expression.

To ensure reliable error-free transmission of MIDI data always use high-quality MIDI cables obtained from your Yamaha dealer or music equipment store. Also avoid MIDI cables that are longer than about 15 meters, since cables longer than this can pick up noise which can cause data errors.

The VL1 MIDI transmit channel, receive channel, local on/off, and device number parameters are available in the utility mode “MIDI Setting” page described on page 155 of the Feature Reference manual. Make sure these parameters are set to match the corresponding settings of the external MIDI device(s) used with the VL1.

### ● The VL1 transmits and receives the following MIDI data:

<b>Note</b>	The played key(s) and velocity value.
<b>Control Change</b>	Modulation wheel, foot controller, breath controller, and other controller data.
<b>Program Change</b>	Voice numbers from 1 to 128.
<b>Aftertouch</b>	Keyboard aftertouch pressure.
<b>Pitch Bend</b>	Pitch bend wheel position.
<b>Bulk</b>	Voice and system parameters transmitted in the form of “bulk dumps”.



**NOTES** ■ For detailed MIDI specifications refer to the “MIDI Data Format” .

■ When using the VL1 with other MIDI equipment, it is a good idea to refer to the MIDI specifications (implementation chart, MIDI data format) of the equipment used to ensure compatibility.

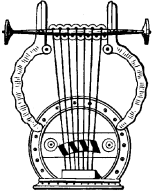

## Power-on Procedure

Always follow proper procedure when powering-up a sound system to minimize the possibility of damage to the equipment (and your ears!).

1. Make sure your sound system’s main level/volume control(s) and the VL1 volume control are turned all the way down prior to turning power on.
2. Turn on the VL1.
3. Turn on the sound system.
4. Raise the sound system volume to a reasonable level.
5. Gradually raise the VL1 VOLUME control while playing the keyboard to set the desired listening level.

**NOTES** ■ The VL1 automatically transmits MIDI control change data corresponding to its control status when its power switch is turned ON or OFF. This can interfere with operation of other MIDI equipment connected to the VL1 MIDI OUT connector. If the VL1 is connected to other MIDI equipment, the VL1 power switch should be turned ON first, and turned OFF last.

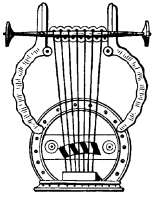

## Play the Demo

Once you've set up your VL1 system, you might like to play the pre-programmed demo sequence to hear how some of the voices sound. This process will also help to familiarize you with some of the VL1's selection and editing procedures.



**IMPORTANT!**

**IMPORTANT! ■** When you run the demo the VL1 automatically loads the required voices and system data into the 16 bank-H voices, thus erasing any previous data in these memory locations. This is the same as the data initially contained in these memory locations when the VL1 is first shipped, so if you haven't made any changes there is no problem. If, however, you have edited the bank-H data or saved data from another bank or disk to this bank, you may want to save your data to floppy disk before running the demo.

### 1. Select the Utility Mode System Page

Press the **UTILITY** button to select the utility mode. Then, if it is not already selected when the utility mode display appears, press the **F1** button to select the "System" function page.

```
UTIL
<System>
1:K90 Setting          5:Curve
2:TG Setting           6:Miscellaneous
3:MIDI Setting
4:Assignable Ctrl
Sys Bulk Disk Recl Demo
```

### 2. Select the Demo Page

Press the **∞** button to select the "Demo" page.

```
UTIL
<Demo>

System data and Bank H voice data will
be erased!
Push ENTER, if OK.

Sys Bulk Disk Recl Demo
```

### 3. Press **ENTER** and Confirm

Press the **ENTER** button if it's OK to go ahead with the demo — and rewrite all bank-H data. The VL1 will ask you to confirm again: press **INC** to continue or **DEC** to abort.

```
UTIL
<Demo>
Sy
be Are You Sure? Yes[INC]/No[DEC] i11
Pu
SYS Bulk Disk Recl Demo
```

### 4. Select a Song

Use the data dial or **DEC** and **INC** buttons to select the song number you want to start with.

```
UTIL/DEMO
<Top Song Select>
Top Song = 01:Moby
Stop Run
```

### 5. Run the Demo

Press the **F8** button to run the demo. Playback will start with the selected song, then all other songs will be played in sequence. The cycle will repeat until stopped.

```
UTIL/DEMO
<Top Song Select>
Top Song = 02:BN.H.Strain
Stop Run
```

**6. Stop the Demo**

Press the **F7** button to stop demo playback.

**7. Return To the Play Mode When Done**

Press the MODE **PLAY** button to return the PLAY mode.



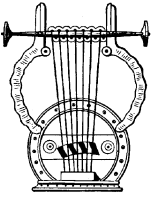

## Breath Controller Calibration

Proper operation of the breath controller is vital to achieving the best possible sound from the VL1. Although the controller is factory-calibrated to match most requirements, we recommend that you carefully calibrate the breath controller for optimum performance with your own playing style.

### 1. Make Sure the Breath Controller Is Connected

Make sure the breath controller is properly connected: turn the power OFF, plug in the breath controller, then turn the power ON.

### 2. Select the Utility Mode System Page

Press the **UTILITY** button to select the utility mode. Then, if it is not already selected when the utility mode display appears, press the **F1** button to select the “System” function page.

```

UTIL
<System>
1:Kb Setting      5:Curve
2:IG Setting      6:Miscellaneous
3:MIDI Setting
4:Assignable Ctrl
Sys Bulk Disk Recl Demo
  
```

### 3. Go To the Utility Mode Curve Page and Select “Brth”

Use the cursor buttons to move the cursor to “5:Curve”, then press **ENTER** to call the “Curve” function page. When the curve display appears press the **F8** function button (“Brth”) to call the breath controller curve page.

```

UTIL/SYSTEM/CURVE
Breath Control
Curve = Normal
0
0
Sys Bulk Disk Recl Demo Velo Aftr Brth
  
```

### 4. Adjust the Breath Controller Offset

The following adjustment must be performed while not blowing into the breath controller mouthpiece. Do not hold the breath controller in your mouth.

Rotate the breath controller OFFSET trimmer slowly clockwise, using the supplied screwdriver, until the vertical cursors above and below the curve graph move slightly to the right and the number below the graph is greater than “0”. Then slowly rotate the trimmer carefully counter-clockwise until the number below the graph just reaches “0” (the cursors will be lined up with the left end of the graph), then stop. This completes the offset adjustment.

## 5. Adjust the Breath Controller Gain

Place the breath controller mouthpiece in your mouth and blow — notice that the cursors move to right and the number below the graph increases according to how hard you blow. Rotate the breath controller GAIN trimmer counter-clockwise as far as it will go (don't force it!) then, while blowing into the mouthpiece using the maximum pressure you intend to use while playing, rotate the trimmer slowly clockwise until the number below the graph just reaches "127" (the cursors should just line up with the right end of the graph) and then stop. This completes the gain adjustment.

**NOTES** ■ *In addition to calibrating the breath controller, the UTILITY mode "Curve" page described here also allows you to select a range of 4 different response curves — these are discussed in more detail on page 157 of the Feature Reference manual.*

## 6. Return to the Play Mode

Press the **PLAY** button to return to the PLAY mode.



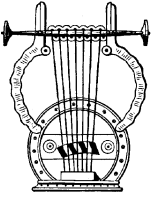

## Load the Pre-programmed Voice Data

Although the factory pre-programmed voices, performance combinations, and patterns are stored in the VL1 internal memory when the instrument is initially shipped, there is always a possibility that all or part of the memory has been erased or modified by the time the instrument gets to you. Here's how you can re-load all the pre-programmed data from the supplied voice disk.

**NOTES ■** Loading the pre-programmed voices overwrites any other data that is in the VL1 internal memory, so if you have any important voices in memory make sure it is safely stored to disk before loading the data — Feature Reference manual, page 166.

### 1. Insert the Voice Disk

Insert the voice disk into the disk drive. The sliding disk shutter should go in first, and the label side of the disk should face upward.

### 2. Select the Utility Mode System Page

Press the **UTILITY** button to select the utility mode. Then, if it is not already selected when the utility mode display appears, press the **F1** button to select the “System” function page.

```

UTIL
<System>
1:KBD Setting          5:Curve
2:TG Setting           6:Miscellaneous
3:MIDI Setting
4:Assignable Ctrl
Sys Bulk Disk Recl Demo
  
```

### 3. Go To the Miscellaneous Page & Turn Memory Protect Off

Use the cursor buttons to move the cursor to “6:Miscellaneous”, then press **ENTER** to call the “Miscellaneous” function page.

```

UTIL
<System>
1:KBD Setting          5:Curve
2:TG Setting           6:Miscellaneous
3:MIDI Setting
4:Assignable Ctrl
Sys Bulk Disk Recl Demo
  
```

Use the cursor buttons to select the “Memory Protect” parameter, then press **DEC** to turn memory protect “off”.

```

UTIL/SYSTEM/MISCELLANEOUS
Display                = Normal
Confirm                = on
Memory Protect         = off
Greeting Message      = QL is the best SYNTH
Sys Bulk Disk Recl Demo
  
```



#### 4. Select the Disk Function Directory

Press the **F3** function button (“Disk”) to select the utility mode disk function directory.

```

UTIL
<Disk>
1:Disk Status      5:Delete File
2:Load From Disk  6:Format Disk
3:Save To Disk
4:Rename File
Sys Bulk Disk Recl Demo
    
```

#### 5. Select “Load From Disk”

Use the cursor buttons to move the cursor to “2:Load From Disk” and then press **ENTER**.

```

UTIL/DISK/LOAD FROM DISK
<Load From Disk>
1:All              5:1 Voice
2:System
3:All Voice
4:1 Bank
Sys Bulk Disk Recl Demo
    
```

#### 6. Select “All” and Select the “CUSTOMER:All” File

Make sure the cursor is positioned at “1:All” and press **ENTER**.

```

UTIL/DISK/LOAD FROM ALL SRC FILE
<Load From Disk> 001:CUSTOMER:All
                  002:FACTORY :All
                  003:EXAMPLE :All
1:All
2:System
3:All Voice
4:1 Bank
Sys Bulk Disk Recl
    
```

When the list of files appears use the cursor **▲** and **▼** buttons to select the “CUSTOMER:All” file, then press **ENTER** again.

```

UTIL/DISK/LOAD FROM ALL SRC FILE
<Load From Disk> 001:CUSTOMER:All
1:All
2:8 Are You Sure? Yes[INC]/No[DEC]
3:A
4:1
Sys Bulk Disk Recl
    
```



## 7. Load the File

Loading will begin when you press the **[INC]** button in response to the “Are You Sure?” prompt. A bar graph on the display will indicate the progress of the load operation, and when all the data has been loaded “Completed!” will appear.



## 8. Return to the Play Mode & Eject the Disk

When the “Completed!” display appears, press the **[PLAY]** button to return to the play mode, then press the eject button below the disk drive slot to eject the disk. Store the disk in a safe place. You must now select a voice in order for the loaded data to be properly activated — see the following section.

### About the VL1 Data Disk

The floppy disk supplied with the VL1 contains the following files:

- **CUSTOMER:ALL**

A complete set of 128 voices and system data in which the voices are programmed to allow maximum controller variation. The MODULATION 2 wheel should be at its center position for “normal” sound.

- **FACTORY:ALL**

A complete set of 128 voices and system data in which the voices are programmed for easy playability — the controller range is not as broad as the CUSTOMER.ALL voices.

- **EXAMPLE:ALL**

Some example voices in which the controller settings are emphasized.

# Voice Selection

Selecting & Playing the VL1's 128 Voices



One of the first things you'll want to do with your VL1 is select and play some of its voices ... this section will show you how to do just that.

## 1. Select the Play Mode

Press the **PLAY** button so that its indicator lights and the word "PLAY" appears in the upper left corner of the LCD panel.

A considerable amount of information appears on the play-mode display in addition to the name of the currently selected voice. Many of the functions relating to this information will be covered later in the manual. For now, here are the basics:

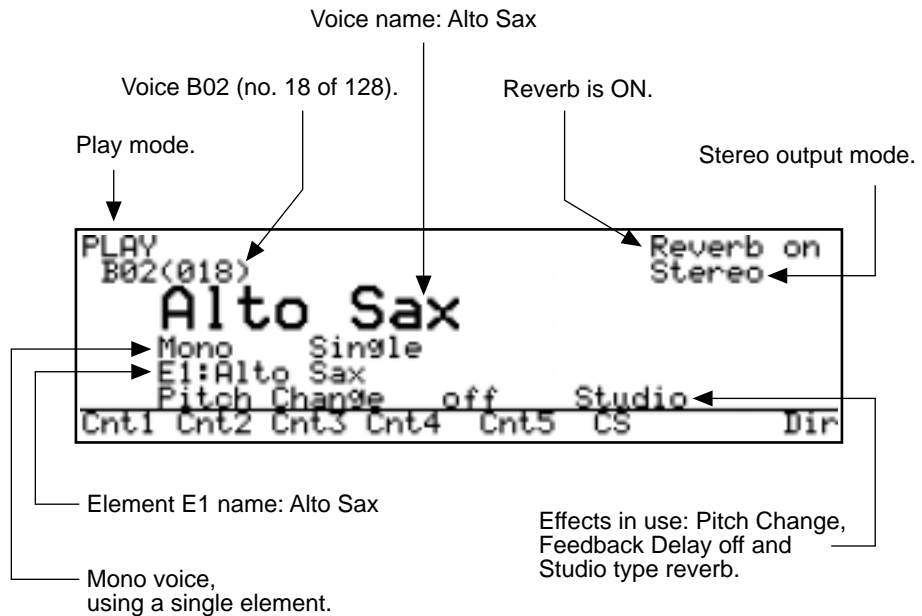

The abbreviations in the section separated by a line at the bottom of the display ("Cnt1", "Cnt2", etc) indicate the functions of the corresponding function buttons below the display: **F1** through **F8**. These will be discussed later in this section.



## 2. Select a Voice

The VL1's 128 voices are organized into 8 banks of 16 voices each (8 x 16 = 128). Any voice can be selected by specifying its bank using the bank buttons (A through H), and its number using the voice number buttons (1 through 16).

To select voice "B2", for example, first press the bank B button and then the voice number 2 button. The bank B button indicator will flash until the voice number 2 button is pressed and the B2 voice is actually engaged.

Note that when you select a different bank (or even press the current bank button) the voice directory for the selected bank will appear on the display, showing the names of all voices in that bank with the cursor located at the currently selected voice number. The VL1 returns to the normal voice display as soon as you specify the voice number. You can also press the ENTER button if you want to stay with the same voice number.

```
PLAY/DIRECTORY
B02(018):Alto Sax
Bank B
01:Backwar 05:Horn 09:JazzGui 13:Yhokihi
02:Alto SE 06:SO / 50 10:HarmoPh 14:BlueBot
03:Pan PIP 07:C Flute 11:Fiddler 15:Clarine
04:MelodyB 08:HurdYGu 12:Floboe 16:Jurassi
Cnt1 Cnt2 Cnt3 Cnt4 Cnt5 CS Dir
```

To select a different voice within the same bank it is only necessary to press the appropriate voice number button. To select a different bank, however, you'll always have to press both a bank button and a voice number button (or the ENTER button). This prevents unwanted voices from being selected until you've actually specified both the bank and number of the voice you want to use.

### Alternate Voice Selection Methods

- The INC and DEC Buttons are best used for small, step-wise changes — e.g. selecting adjacent voice numbers, or numbers that are only a few steps away.

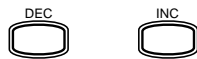

Press the DEC or INC button briefly to decrement or increment the voice number by one, or hold either button for continuous decrementing or incrementing in the corresponding direction. The bank will switch automatically if you cross a bank voice-number boundary.

- The Data Dial provides a fast, efficient way to cover a broad range of voice numbers when, for example, you're looking for a voice but don't know the voice number. Simply rotate the data dial clockwise for higher voice numbers or counter-clockwise for lower voice numbers while watching the display.

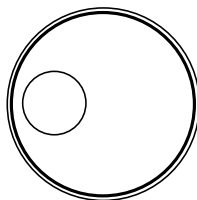

The banks are automatically switched when necessary as the voice numbers are changed.

### 3. Play

Try playing the selected voice on the keyboard. Select a number of different voices and try them out. You will have to apply breath pressure to the breath controller, press the foot controller forward, or roll the [MODULATION 2] wheel upward to produce sound with many of the VL1's voices. A complete list of the pre-programmed voices and their controller assignments is provided in the Voice List & MIDI Data Format. A brief voice list is provided below. The VL1 also provides “controller views”, described in the next chapter, that let you check the current controller assignments via the VL1 display.

**NOTES** ■ *If you don't get any sound at this point: Make sure your sound system is turned ON and the volume is turned up to a reasonable level, make sure that the VL1 VOLUME control is turned up to a reasonable level, and check all connections carefully.*

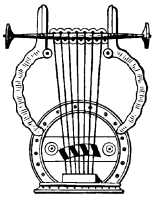

## Using the Voice Directory

Although the voice directory appears automatically any time you select a different bank, you can have the directory displayed continuously if you find it more convenient than the normal voice display. To switch to the voice directory display, press the [F8] button — located directly below “Dir” on the display. Voices are selected using the same methods described in the preceding section, and the cursor buttons or data dial will move to the selected voice.

To return to the normal voice display press the [EXIT] button.



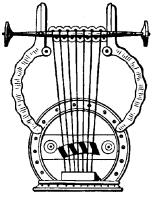

## The Pre-programmed VL1 Voices

Here's an abbreviated voice list for easy reference.

Voice No.	Voice Name	Voice No.	Voice Name	Voice No.	Voice Name	Voice No.	Voice Name
A01 (001)	Moby	C01 (033)	Gonzilla	E01 (065)	Dr.Bonky	G01 (097)	Lees
A02 (002)	Tenor Sax	C02 (034)	Soprano 1	E02 (066)	Bell Miked	G02 (098)	Breath Sax
A03 (003)	Shakuhachi	C03 (035)	MouthKeys	E03 (067)	Blues Harp	G03 (099)	Bowed Saw
A04 (004)	FingerBass	C04 (036)	Thump Bass	E04 (068)	Slap Bass	G04 (100)	Birdland
A05 (005)	Trumpet	C05 (037)	Cornet	E05 (069)	Muted Lips	G05 (101)	Fanfare
A06 (006)	Ossyncro	C06 (038)	Igneous	E06 (070)	Analunar	G06 (102)	Chalsaw
A07 (007)	Tull Flute	C07 (039)	Alto Flute	E07 (071)	Andean	G07 (103)	Recorder
A08 (008)	Bagpipes	C08 (040)	Khaen	E08 (072)	Sitar	G08 (104)	Harmonium
A09 (009)	GuitarHero	C09 (041)	Cruncher	E09 (073)	Rock Pigs	G09 (105)	WonderBass
A10 (010)	Mizu Horne	C10 (042)	Marsaloboe	E10 (074)	Synth Lite	G10 (106)	NuDbiReed
A11 (011)	Viol Inn	C11 (043)	Eleanor	E11 (075)	St. Ripper	G11 (107)	Viowind
A12 (012)	Endophone	C12 (044)	RichReed	E12 (076)	Scat Harp	G12 (108)	Harmoweird
A13 (013)	JetLipBow	C13 (045)	Breath Bow	E13 (077)	L7 Pluck	G13 (109)	Cyberpluck
A14 (014)	BowBamBoo	C14 (046)	SquealerAT	E14 (078)	Flak	G14 (110)	NuAltoPipe
A15 (015)	Bassoon	C15 (047)	Oboe	E15 (079)	3 AM Blow	G15 (111)	Gerhard
A16 (016)	Digeritek	C16 (048)	Maysbe?	E16 (080)	Yamasteel	G16 (112)	Mad Tube
B01 (017)	Backwards	D01 (049)	BlownDrone	F01 (081)	MoreGrunge	H01 (113)	AcoEkoSyn
B02 (018)	Alto Sax	D02 (050)	Loose Bari	F02 (082)	Soprano 2	H02 (114)	LooseTenor
B03 (019)	Pan Pipes	D03 (051)	Toots	F03 (083)	Ocarina	H03 (115)	Kokyu
B04 (020)	MelodyBass	D04 (052)	Fretless	F04 (084)	Upright	H04 (116)	Tube Bass
B05 (021)	Horn	D05 (053)	Tuba	F05 (085)	Alto&Trump	H05 (117)	TrumpCard
B06 (022)	50 / 50	D06 (054)	Arpoon	F06 (086)	OldMini	H06 (118)	PipeBowBow
B07 (023)	C Flute	D07 (055)	Piccolo	F07 (087)	Fyfe	H07 (119)	BaroquePad
B08 (024)	HurdyGurdy	D08 (056)	Thai Reed	F08 (088)	Squeezebox	H08 (120)	Outback
B09 (025)	JazzGuitar	D09 (057)	Frange	F09 (089)	Mr. Mogue	H09 (121)	FuzzyBass
B10 (026)	Harmophone	D10 (058)	NuSoprPipe	F10 (090)	HyperClari	H10 (122)	Wheed
B11 (027)	Fiddler	D11 (059)	Contraire	F11 (091)	DoubleBow	H11 (123)	Monteverdi
B12 (028)	Floboe	D12 (060)	ClariLip	F12 (092)	RuffWreck	H12 (124)	Sax Git
B13 (029)	Yhokih	D13 (061)	Conchise	F13 (093)	Clavisynth	H13 (125)	Cyberisen
B14 (030)	BlueBottle	D14 (062)	Pastorale	F14 (094)	Claricord	H14 (126)	Clar&Flute
B15 (031)	Clarinet	D15 (063)	Barker	F15 (095)	TrumpNSax	H15 (127)	Saxes
B16 (032)	Jurassic	D16 (064)	FrenchBone	F16 (096)	QuiScivit?	H16 (128)	Isn't Wah

A more detailed voice list is provided in the Voice List & MIDI Data Format.

# The Controllers

*Natural Musical Nuance and Expressive Control*



If you've read the "VL1 Basics" section (if you haven't, please do so — page 8) you should understand the concept of "controllers" as applied to the VL1. The "controller parameters" correspond to simulated characteristics of the instrument model — e.g. breath pressure, embouchure or tonguing. Any of these can be controlled by you via "physical controllers" — e.g. the breath controller or modulation wheel — assigned to the required controller parameter. Even if you never go as far as editing the actual sound of the voices, you'll no doubt want to be able to change these controller assignments and modify the way the controllers affect the sound.

In this section we'll introduce you to the basics of controller assignment and operation.

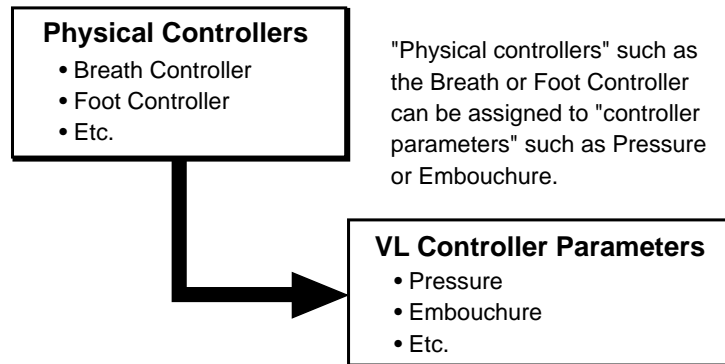

The effectiveness of the VL1 as a musical instrument depends to a great deal on how well you learn to use these controllers. Since the VL1 sound is produced by a computer-based physical model rather than a oscillator-based tone generator, there are no hard-and-fast rules as to how any controller will actually affect the sound. There are guidelines, based on the role of the corresponding controller parameter within the physical model, but proficiency with the VL1 depends more on experience and practice — just as it does in any acoustic instrument.



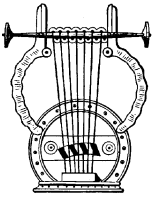

## Physical Controllers

First, here's a list of the physical controllers available for use with the VL1:

<b>Breath Controller</b>	A natural candidate for controlling pressure, tonguing, throat, growl, and other parameters.
<b>Breath Attack</b>	This unique "controller" can be applied only through the Breath Controller. When it is selected control is applied by <i>changes</i> in breath pressure, rather than the absolute breath pressure itself. A constant pressure — whether zero or maximum — produces no change. The faster the change in pressure, the higher the control value.
<b>Pitch Wheel</b>	The self-centering VL1 pitch wheel can be assigned to a range of parameters, but it's "standard" function is pitch control. A controller parameter such as Embouchure can also be assigned to the pitch wheel for more realistic pitch variations.
<b>Modulation 1 Wheel</b>	This wheel produces minimum effect in its lowest position and maximum effect in the highest position. This modulation wheel is permanently assigned to the standard MIDI modulation wheel control change number — 001.
<b>Modulation 2 Wheel</b>	The VL1's second modulation is not self-centering, but it has a center click-stop which makes it ideal for assignment to parameters that have a "normal" central setting with variations above and below. It can also be assigned to any MIDI control change number, function in the same way as the breath controller, foot controller, etc.
<b>Foot Controller 1</b>	Foot controller 1 has the standard MIDI foot controller control change number — 004 — and can be assigned to any VL1 controller parameter.
<b>Foot Controller 2</b>	Like the modulation 2 wheel, foot controller 2 is assignable to any MIDI control change number, and is frequently assigned to function in the same way as the breath controller. It can also be assigned to any VL1 controller parameter.
<b>Foot Switches 1 &amp; 2</b>	In addition to their obvious sustain and portamento functions, the foot switches are independently assignable to any MIDI controller function as well as a voice number increment function. Of course, they are only really useful with on/off type parameters — not with parameters that allow continuous control.
<b>Aftertouch</b>	Keyboard aftertouch allows you to control any controller parameter by the pressure you apply to a key after it is initially pressed. This is perhaps the most "intimate" type of keyboard expression control.
<b>Velocity</b>	Although normally assigned to pressure (particularly in plucked string voices), keyboard velocity can also be assigned to any other controller parameter.
<b>MIDI</b>	The MIDI protocol provides 119 control change numbers, some of which are pre-assigned to specific controllers — "001" is "Modulation Wheel", for example. All of these are available for assignments to the VL1 controller parameters, so external MIDI control devices can be used to full advantage.



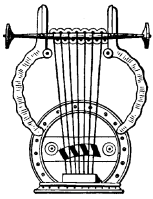

## VL1 Controller Parameters

Any of the physical controllers listed above can be assigned to control any of the VL1's controller parameters:

<b>Pressure</b>	The amount of breath pressure applied to a reed or mouthpiece, or the speed of the bow applied to a string. Pressure variations affect both volume and timbre.
<b>Embouchure</b>	The tightness of the lips against the reed or against each other. In a string instrument voice Embouchure corresponds to how strongly the bow is pressed against the string. Affects both pitch and timbre.
<b>Pitch</b>	Changes the length of the air column, and thereby the pitch of the sound. The PITCH wheel is usually assigned to this parameter.
<b>Vibrato</b>	A standard vibrato (pitch modulation) effect. An extensive range of parameters makes it possible to achieve extremely natural vibrato effects. The amounts of vibrato applied via pitch and embouchure, for example, are independently programmable.
<b>Tonguing</b>	Simulates the half-tonguing technique used by saxophone players by changing the "slit" of the reed. The slit is the space between the tip of the reed and the mouthpiece.
<b>Amplitude</b>	Unlike Pressure, this parameter simply controls the volume of the sound without varying timbre.
<b>Scream</b>	Drives the entire system into chaotic oscillation, creating effects that can only be achieved with physical modeling technology.
<b>Breath Noise</b>	Adds breath noise. The sound of the breath noise itself can be varied over a wide range using the EDIT mode "Breath Noise" parameters — Feature Reference manual page 73.
<b>Growl</b>	A periodic pressure modulation which produces the "growl" effect often heard in wind instruments. Like vibrato, an extensive range of parameters allow remarkably realistic effects.
<b>Throat Formant</b>	Controls the characteristics of the simulated player's lungs, trachea, and oral cavity. Can add a realistic "roughness" to the sound.
<b>Dynamic Filter</b>	Similar to the dynamic filters found in many conventional synthesizers. The VL1 filter has selectable high-pass, bandpass, band elimination, and low-pass modes.
<b>Harmonic Enhancer</b>	The Harmonic Enhancer can vary the harmonic structure of the sound over a wide range. The Harmonic Enhancer also includes parameters that affect breath noise and several reed characteristics.
<b>Damping</b>	Simulates the effect of damping at the end of the air column or string. Affects both pitch and timbre.
<b>Absorption</b>	Similar to the above, but simulating the effect of absorption at the end of the air column or string. In the case of a wind instrument, the Damping and Absorption parameters control the diameter and shape of the bell.



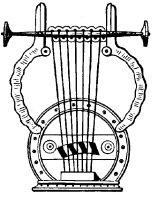

## Controller Views

In the PLAY mode, function buttons [F1] through [F6] are used to select “controller view” displays that list all controller assignments for the currently selected voice. In particular, [F1] through [F4] display the assignments for the controller parameters listed in the preceding chart (you can press the [EXIT] button at any time to return to the normal play-mode display).

[F1]	<pre> PLAY/CONTROLLER VIEW 1 B02(018):Alto Sax ----- Pressure           Element1 Embouchure         Breath Con Pitch              Pitch Bend Pitch              Pitch Bend Vibrato            Modulation Cnt1 Cnt2 Cnt3 Cnt4 Cnt5 CS      Dir </pre>
[F2]	<pre> PLAY/CONTROLLER VIEW 2 B02(018):Alto Sax ----- Tonguing          Foot Contr Amplitude         off Scream            off Breath Noise      Velocity Cnt1 Cnt2 Cnt3 Cnt4 Cnt5 CS      Dir </pre>
[F3]	<pre> PLAY/CONTROLLER VIEW 3 B02(018):Alto Sax ----- Growl             off Throat Formant    After Touc D.Filter          Breath Con H.Enhancer        Velocity Cnt1 Cnt2 Cnt3 Cnt4 Cnt5 CS      Dir </pre>
[F4]	<pre> PLAY/CONTROLLER VIEW 4 B02(018):Alto Sax ----- Damping           off Absorption        off Cnt1 Cnt2 Cnt3 Cnt4 Cnt5 CS      Dir </pre>

The controller parameters are listed in the left column of the controller view display, and the controllers assigned to them are listed in the center column. Note that the right column is empty. This is because the AltoSax voice used for this example only uses one element, so the controllers are listed in the central “Element1” column. In a voice that uses two elements the “Element2” controllers are independently assignable and are listed in the right column.

In this example we can see that the breath controller is assigned to control “Pressure” and “H. Enhancer” (the Harmonic Enhancer). The pitch wheel controls both “Pitch” and “Embouchure”, and the modulation wheel (MODULATION 1) controls “Vibrato”. Keyboard aftertouch controls the “Throat” parameter. The remaining parameters are currently “off” and therefore have no effect on the sound.

**NOTES** ■ The ∞ (“Cnt5”) and [F6] (“CS”) function buttons access controller views that deal with different types of controllers. These will be summarized in the “Other Controller Views section on page 47 of this manual.

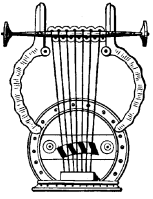

## Some Exercises With the AltoSax Controllers

Now that you know which physical controllers are assigned to which controller parameters in the AltoSax voice, play the voice using the assigned controllers to get a feel for their effect before changing the assignments.

### 1. Engage the EDIT Mode

The controller assignments are accessed via the EDIT mode Controller page. To get to this page first press the **[ENTER]** button to engage the edit mode. This is the initial EDIT mode display:

```

EDIT
B02(018)
Voice Name = Alto Sax
Key Mode = Mono
Voice Mode = Single
E1 Name = Alto Sax
Com E1
Name
  
```

If the initial EDIT mode display shown above does not appear when the **[EDIT]** button is pressed, try pressing the **[EXIT]** button one or more times.

**NOTES** ■ When the edit mode is selected, the VL1 will automatically go straight to the last edit page that was selected for maximum programming speed and efficiency. You may have to **[EXIT]** through one or two layers of the EDIT mode display hierarchy to return to the initial display.

### 2. Select the Element 1 Controller Parameters

Press the **[F2]** function button (immediately below “E1” on the display) to select the element-1 parameters (“E2” also becomes available for access via **[F3]** when editing a voice that uses two elements).

```

EDIT/E1
B02(018):Alto Sax /E1:Alto Sax
<Controller>
01:Pressr 05:Trnging 09:Growl 13:Damping
02:Embchr 06:AmPltd 10:Throat 14:AbsrPtn
03:Pitch 07:Scream 11:D.Filtr
04:Vibrato 08:B.Noise 12:H.Ehnc
Ctrl Misc Modi Env S&R
  
```

If the display doesn't look like this press the **[F1]** function button (below “Ctrl” on the display) to call the “Controllers” page.

### 3. Select the Controller Parameter You Want To Edit

Use the cursor buttons to select the controller parameter you want to assign a controller to (you can also use the **[DEC]** and **[INC]** buttons or data dial for this), then press the **[ENTER]** button.

For example, let's try adding scream control to the MODULATION 1 wheel (it currently controls vibrato). Move the cursor to “07:Scream” and press **[ENTER]**.



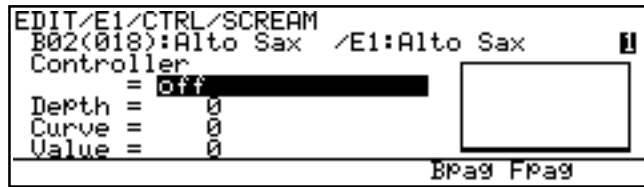

#### 4. Edit the Scream Controller Parameter

The cursor should be located at the “Controller” parameter, as shown in the example display. In the AltoSax voice the scream control parameter is not used so it is currently turned “off”. Press the **[INC]** button or rotate the data entry dial to the right slightly to select “Modulation Wheel”, the first controller on the list.

Notice that as soon as you edit the parameter, an inverse letter “E” (**[E]**) appears to the left of the voice number near the upper left corner of the display. This tells you that the voice has been edited and, later, that you’ll need to store the voice in memory before selecting a different voice if you want to keep the edited data.

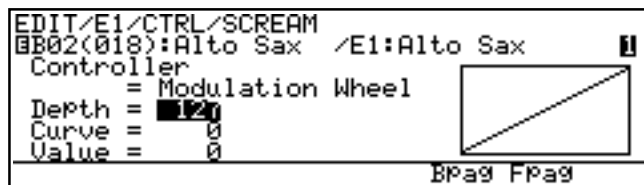

**NOTES** ■ The Controller parameter has 124 settings — corresponding to the 124 controller number provided by MIDI protocol. Some of these are pre-assigned: Modulation Wheel is number 001, Breath Controller is number 002, etc. When you select a pre-assigned controller the corresponding controller name is shown on the display; non-assigned controllers are displayed as MIDI control change numbers.

■ The “Modulation Wheel” setting refers to the VL1’s MODULATION 1 wheel. The MODULATION 2 wheel can be assigned to any MIDI control change number.

#### 5. Try Out the Edited Voice & Cancel the Vibrato Effect

Try operating the **[MODULATION 1]** wheel while playing the AltoSax voice. You should hear the scream effect increase as the wheel is rolled upward. Vibrato is still assigned to the **[MODULATION 1]** wheel, so the vibrato effect will come in simultaneously.

To cancel the vibrato effect and leave only the scream effect, simply go to the Controller “VIBRATO” page and turn the Controller parameter “off”. To get to the vibrato page you can either **[EXIT]** to the controller directory introduced in step 2 and select the vibrato page from there, or step backward through the controller pages by using the **[F6]** function button (“BPag” stands for “Back page”). In the same way, the **[F7]** function button can be used to step forward through the controller pages (“FPag”).

**NOTES** ■ When “Para” appears above the **[F8]** function button, as it does in the vibrato and several other controller pages, the **[F8]** function button accesses another page of parameters pertaining to the controller.

## 6. Go to the Pressure Controller Page

From the Vibrato page use the [F6] button to step back to the Pressure controller page. Quite logically, the Breath Controller is assigned to control the “Pressure” parameter, and we will leave it set that way while we experiment with the “Depth” and “Curve” parameters.

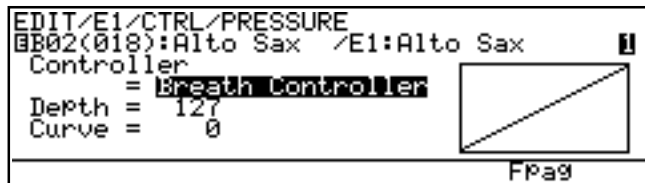

## 7. Vary the Depth Parameter

Move the cursor to the “Depth” parameter and, while trying out the effect of the changes on how the “Pressure” parameter is affected by the Breath Controller, use the data dial to vary to depth setting.

As you decrease the setting, notice that the graph to the right of the display changes accordingly. The horizontal axis corresponds to breath pressure (or the control value in any other controller screen), and the vertical axis represents the depth of the parameter. With “Depth” set to the maximum value of “127” no breath pressure produces no sound and maximum breath pressure produces maximum output.

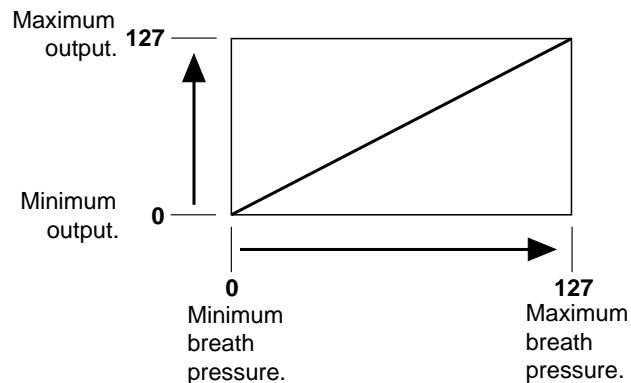

As the value of the “Depth” parameter approaches zero, however, the depth of the output range is reduced and a corresponding amount of output is produced even at minimum breath pressure. In other words, at a setting lower than 127 simply playing a key will produce sound even without breath pressure, and the Breath Controller will vary output between the initial level and maximum output.

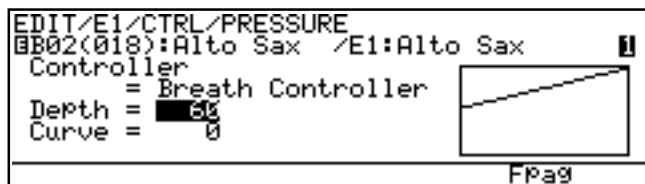

Once you pass zero, you enter a range of “negative” Depth values that produce reverse controller operation: i.e. the output level decreases as you blow harder into the Breath Controller. Like the normal positive range, the negative Depth range is from “0” to “-127”.

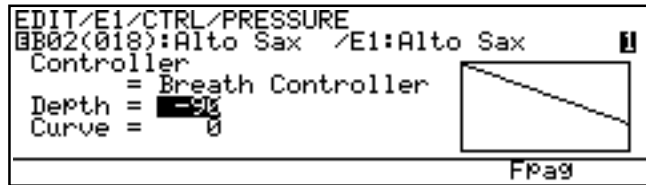

**NOTES** ■ Many parameters with any relationship to MIDI control have a range of values from -127 through 0 to 127 (255 steps). This corresponds to the range of values that can be represented in binary form by one “byte” (8 bits) of data — the number MIDI uses to convey control values.

## 8. Vary the Curve Parameter

You may have noticed in the previous step that the relationship between breath pressure and output is linear. That is, a change in breath pressure produces a corresponding change in sound. The “Curve” parameter makes it possible to change that relationship.

As you increase the curve value (the maximum value is 16), the line on the graph which represents breath pressure versus output will curve downward, as shown in the display below (setting “12”). The result is that the lower end of the breath pressure range has relatively little effect on the sound, while higher breath pressures produce more dramatic changes.

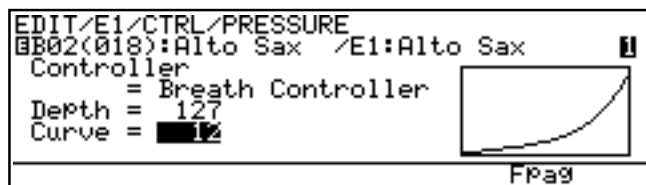

Negative curve values (0 ... -16) have the opposite effect: Output increases rapidly at low breath pressures while higher pressures produce relatively little effect.

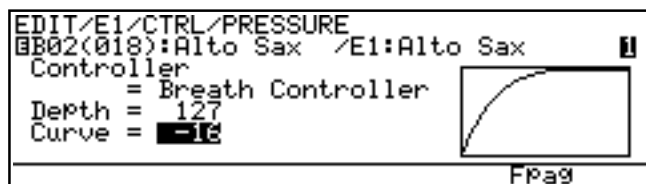

## 9. Experiment!

Now that you've got the idea, flip through the all the available controller pages and experiment with alternative assignments and settings until you feel comfortable with the system. You should also try this with different voices later, since the controllers can have different effects with different voices.

**NOTES ■** *There are several variations on the basic controller display and parameters. When you're ready to study the parameters in more detail refer to the "Element Controllers" section beginning on page 64 of the Feature Reference manual.*

## 10. Return to the Play Mode When Done

When you're finished experimenting with the controllers, press the **PLAY** button to return to the play mode.

Note that the inverse letter "E" () still appears to the left of the voice number, indicating that the voice has been edited.

```

PLAY                               Reverb on
BB02(018)                           Stereo
  Alto Sax
  Mono      Single
  E1:Alto Sax
  Pitch Change off      Studio
Cnt1 Cnt2 Cnt3 Cnt4 Cnt5 CS      Dir
    
```

If you want to keep the edited voice, it must be saved either to an internal memory location or to floppy disk, as described on pages 28 and 166 of the Feature Reference manual, respectively. This must be done before you select a different voice (or the same voice again) or your edits will be lost. To confirm this, try selecting a different voice and then return to the AltoSax voice ... the inverse "E" () will be gone and the voice will be as it was before you edited it.

**NOTES ■** *The VL1 has a Memory Voice Recall function that can be used to recall the last version of a voice if you accidentally make unwanted changes or lose your edited data as described above — Feature Reference manual, page 172.*

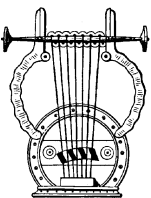

## Controller Envelopes

Since acoustic instruments virtually never respond instantaneously to "controller" changes, the VL1 includes a range of controller envelopes that can be used to simulate this type of response. For example, sudden application of maximum breath pressure to a wind instrument or bow speed to a string instrument normally doesn't produce instantaneous sound. The instrument requires a few milliseconds to reach the full resonance demanded by the breath pressure or bowing. The VL1 provides programmable envelopes for the "Pressure", "Embouchure/Pitch", "Vibrato", "Growl", and "Amplitude/Filter" parameters, and these are described in detail on pages 128 through 150 of the Feature Reference manual.



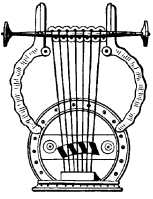

## Other Controller Views

If you press the ∞ function button from the play mode you'll see the following controller view:

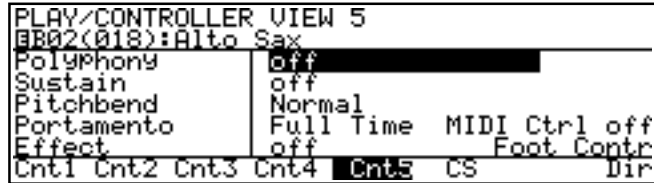

The controller parameters listed in this screen are not in the same category as those discussed in the preceding section, and therefore need to be introduced separately. All of the related parameters will be discussed in detail in the Feature Reference manual (pages listed below).

<b>Polyphony</b>	This line shows which controller is currently assigned to polyphony mono/poly control. (≥ <i>Feature Reference manual, page 36</i> )
<b>Sustain</b>	Indicates whether sustain control is on or off. (≥ <i>Feature Reference manual, page 35</i> )
<b>Pitch Bend</b>	The VL1 has three different pitch bend modes — Normal, Bottom, and Top. The Bottom and Top modes are only effective when the Poly or Unison polyphony mode is selected. When Bottom is selected the lowest of two notes played will be affected by the pitch wheel, and when Top is selected the high note will be affected. When the Normal mode is selected both notes are affected. (≥ <i>Feature Reference manual, page 35</i> )
<b>Portamento</b>	The VL1 offers a choice of portamento modes with or without MIDI control capability. This line indicates the current portamento status. (≥ <i>Feature Reference manual, page 40</i> )
<b>Effect</b>	Any physical controller can be assigned to control certain of the VL1's effects in certain ways: the wet/dry balance of the pitch change effect, the feedback delay send level, or the reverb send level. This line indicates which effect parameter is assigned for control by which controller. (≥ <i>Feature Reference manual, page 45</i> )

The [F6] function button calls the Continuous Slider (“CS”) controller view, which will look something like this:

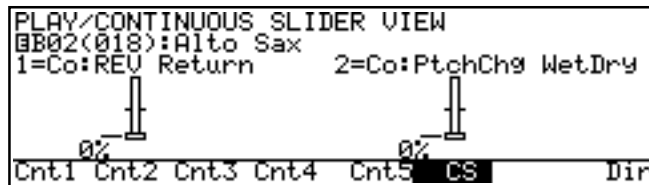

The continuous sliders can not be assigned to the instrument controller parameters listed above, but can be independently assigned to several other parameters that you can control in real time while playing. The parameters available for editing via the continuous sliders are individually preset for each voice. You can select from the available range by using the “Continuous Slider” assignment function described on page 43 of the Feature Reference manual.

The continuous slider view shows you which parameters are assigned to which controller as well as the current positions of the controllers and their corresponding values.



# Mixing & The Modifiers

*Creating New Timbres and Original Voices*



The VL1 provides two ways to change the timbre of a voice to create original variations: 1) by mixing the output signals from various parts of the physical model, and 2) by using the VL1’s “Modifiers” to shape the overall harmonic structure. You should always start with the mixing parameters when attempting to create a new voice, so we’ll describe mixing first.

## Mixing

The VL1’s physical instrument model produces three output signals that can be mixed to produce a surprising range of timbral variation.

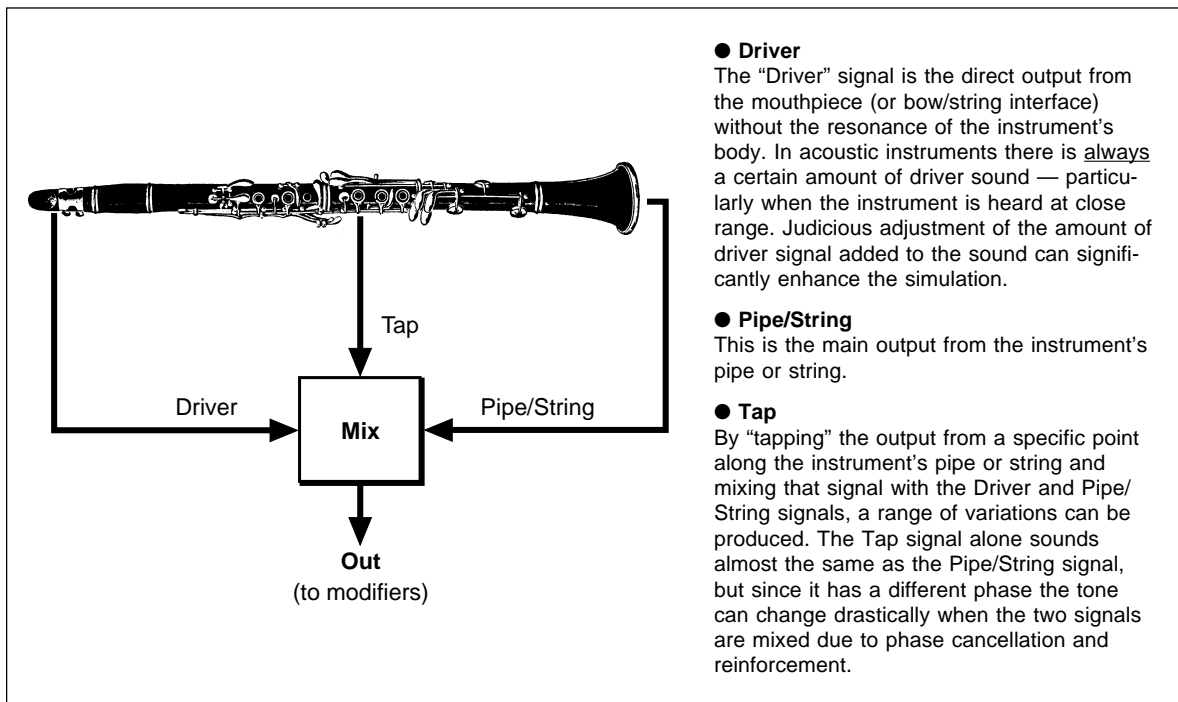

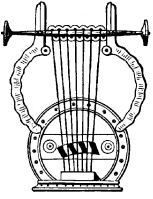

## An Exercise: Remix the Pan Pipes Voice

Before going to the EDIT mode, select and play the Pan Pipes voice for a few minutes to get a feel for how it sounds.

### 1. Engage the EDIT Mode

The mixing parameters are accessed via the EDIT mode “Mixing” page. To get to this page first press the **[EDIT]** button to engage the edit mode. You may have to press the **[EXIT]** button one or more times to get the initial edit display.

```

EDIT
B03(019)
Voice Name = Pan Pipes
Key Mode = Mono
Voice Mode = Single
E1 Name = Pan Pipes
Com E1
Name
  
```

### 2. Select the Element 1 Miscellaneous Parameters

Press the **[F2]** function button to select the element-1 parameters, then press the **[F2]** function button again (below “Misc” on the display) to call the “Miscellaneous” page.

```

EDIT/E1
B03(019):Pan Pipes /E1:Pan Pipes
<Miscellaneous>
1:Setting 5:Amplitude
2:Breath Noise
3:Throat Formant
4:Mixing
Ctrl Misc Modi Env
  
```

### 3. Select & Edit the Mixing Parameters

Move the cursor to “4:Mixing” and press **[ENTER]**.

```

EDIT/E1/MISC/MIXING
B03(019):Pan Pipes /E1:Pan Pipes
Driver Output = 127
Pipe/String Output = 127
Tap Output = 127 Tap Sign = -
Tap Setting = Driving Point
KSC
  
```

Here you have all the parameters you need to mix the physical model output signals: Driver Output, Pipe/String Output, and Tap Output. These three parameters can be set from “0” (no output) to “127” (maximum output). Try changing their values to see how the sound is affected.

Note that in the example display there are more Tap parameters. There is actually one more: move the cursor to the “Tap Setting” parameter and press the **[DEC]** button (or use the data dial) to set it to “Variable” (the previous setting, “Driving Point”, fixes the position of the tap output at the instrument’s driving point). Now the location of the tap can be set at any point via the “Tap Location” parameter. Try changing the “Tap Location” setting and notice how the tone changes.

```
EDIT/E1/MISC/MIXING
BB03(019):Pan Pipes /E1:Pan Pipes
Driver Output      = 00
Pipe/String Output = 1270
Tap Output         = 1270 Tap Sign = -
Tap Setting        = Variable
Tap Location       = 0.024
```

#### Tap Location

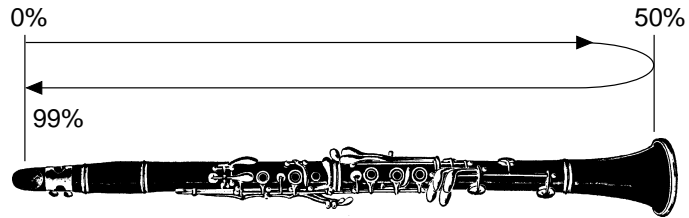

The remaining tap parameter — “Tap Sign” — inverts the phase of the tap signal. It has two settings: “+” and “-”. Try it.

#### 4. Return To the PLAY Mode When Done

Press the **PLAY** button to return to the PLAY mode when you’ve finished experimenting with the mixing parameters.

After experimenting with the Mixing parameters for a while you’ll discover that they define the basic sound of the instrument. Once you’ve created the basic sound you want by using the Mixing parameters, then you can move on the Modifiers to refine the sound.



# The Modifiers

As described in the “VL1 Basics” section (page 8), the VL1 has five “Modifier” stages that shape the overall timbre of the sound. Although the modifiers can vary the sound over a considerable range, the fundamental timbre of each voice is determined by its physical instrument model. If you start with a trumpet voice, for example, the modifiers will let you create an broad range of timbres, but the final sound will always be more or less trumpet-like. It is therefore important to choose a voice that provides the right foundation for the sound you are trying to achieve when attempting to create an original sound.

The five modifier stages are:

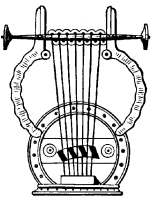
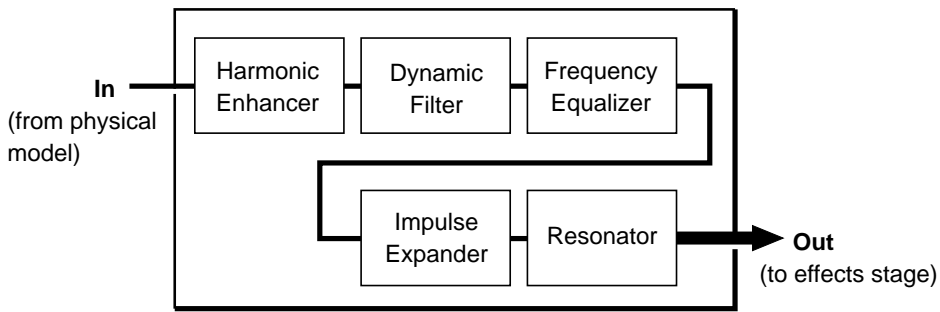

## Harmonic Enhancer

Of the five modifier stages, the Harmonic Enhancer has the most pronounced effect on the actual harmonic structure of the sound. It allows you to create radical timbral variations within the current instrument “family”.

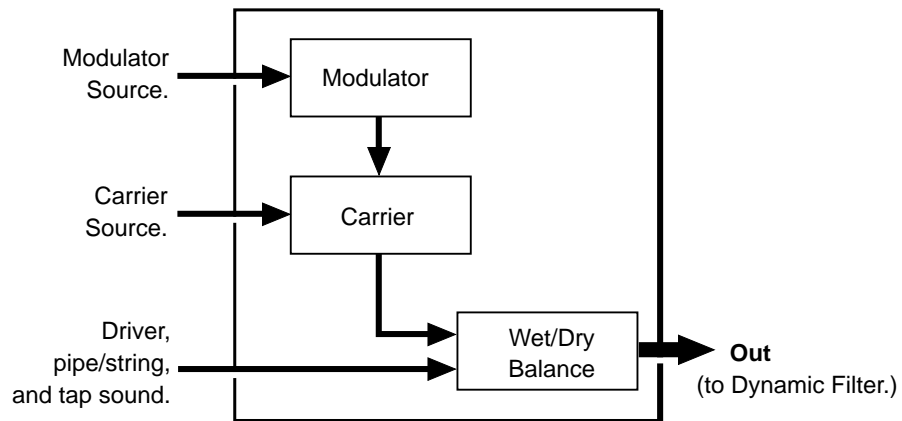

Referring to the block diagram of the harmonic enhancer, above, we can see that it employs a modulation approach to building new harmonic structures. The carrier and modulator blocks have independent display pages and some independent parameters.

### ■ The Modulator Parameter Page

```

EDIT/E1/MODIFIER/HARMONIC ENHANCER
A02(002):Tenor Sax /E1:Tenor Sax
Signal Select = Normal
HPF Cutoff    = 17.0 Hz
Over Drive    = 1.000
Level         = 120
Balance       = -48 Dry Wet
Crr Mod
    
```

### ■ The Carrier Parameter Page

```

EDIT/E1/MODIFIER/HARMONIC ENHANCER
A02(002):Tenor Sax /E1:Tenor Sax
Signal Select = Slit/Friction
HPF Cutoff    = 17.0 Hz
Over Drive    = 1.000
Level         = 120
Balance       = -48 Dry Wet
Crr Mod
    
```

**NOTES** ■ If you want to experiment with the Harmonic Enhancer parameters while reading this section, they can be accessed by selecting the EDIT mode and, from the initial EDIT mode display (try pressing **EXIT** if the initial EDIT display doesn't appear), pressing **F2** ("E1") to select the Element 1 parameters, then pressing **F3** ("Modi") to select the Modifier parameters, and finally moving the cursor to "1:Harmonic Enhancer" and pressing **ENTER**. Once the Harmonic Enhancer display is selected the carrier and modulator pages are selected via **F1** ("Crr") and **F2** ("Mod"), respectively.

The "Signal Select" parameters in these pages allow independent selection of the six different signal sources listed below.

<b>Normal</b>	This is the total output of the instrument model: a mix of the driver, pipe/string, and tap signals.
<b>Breath Noise Amplitude</b>	This signal represents the instantaneous amplitude of the breath noise produced at the driver. It is basically a highly distortion version of the Slit/Friction signal described below.
<b>Flow Rate Saturation</b>	When the pressures on either side of an aperture (e.g. a mouthpiece/ reed assembly) differ, a corresponding flow of air is produced. There is, however, a limit to the speed of the airflow which can be produced (saturation). The relationship between the pressure difference and resulting airflow is derived as the Flow Rate Saturation signal.
<b>Beat</b>	The beat signal represents contact between the vibrating reed and the mouthpiece.
<b>Slit/Friction</b>	As the reed vibrates, the area of gap (slit) between it and the mouthpiece varies accordingly. The Slit/Friction signal corresponds to the varying area of the reed/mouthpiece slit.
<b>Reed</b>	This signal is derived directly from the flexing of the reed.

Although any modulator source signal can be applied to any carrier source signal, two approaches are recommended when attempting to create an acoustic instrument simulation.

The first is to set the carrier signal to “Normal” and the modulator signal to any other than normal, set the dry/wet “Balance” to 63 (all wet), and set a relatively high modulator “Index” value. In this case the total output of the instrument model (“Normal” signal) will be modulated by one of the component signals, so the dry/wet “Balance” can be set to fully wet (modulated carrier output only) since the carrier source and dry signals are essentially the same. The “Index” parameter determines how much modulation is applied, so a higher value is generally required to create sufficient variation.

The second approach is to set the carrier signal to any other than normal and the modulator signal to any of the six possibilities, set the dry/wet “Balance” to a more central value, and set a relatively low modulator “Index” value. In this situation it is necessary to set the “Balance” more toward the “Dry” side since the carrier source signal is not the normal signal and at least some of the dry signal is necessary to provide the basic sound of the instrument model. In other words, the sound produced by the Harmonic Enhancer is simply added to the basic sound of the instrument, in contrast with the first approach in which the basic sound of the instrument is modulated directly.

Please note that these are only guidelines, and are by no means the only way to work with the Harmonic Enhancer. Since the Harmonic Enhancer tends to respond differently with different instrument models, experimentation and experience are your most valuable tools.

While the “Balance” and “Index” parameters apply to the overall harmonic enhancer sound, the following independent parameters are provided for the modulator and carrier blocks.

<b>HPF Cutoff</b>	Both the modulator and carrier blocks have high-pass filters that can be used to roll off the low frequencies of the corresponding signal. The cutoff frequency can be varied from 17.0 Hz to 11.2 kHz.
<b>Overdrive</b>	This parameter boosts the corresponding modulator or carrier signal, forcing it into distortion and thereby drastically changing its harmonic structure.
<b>Phase</b>	This parameter is provided for the modulator block only. It allows a degree of timbral variation by varying the phase of the modulator signal through 360 degrees in 2- or 3-degree increments.

Look at the Harmonic Enhancer display pages again. Parameters with an inverse “K” (K) next to them can also be controlled by key scaling — i.e. the value of the parameter changes according to the pitch of the key played. This makes it possible to achieve both natural and unprecedented timbral variations across the range of the keyboard.

**NOTES** ■ Refer to page 107 of the Feature Reference manual for full details on the Harmonic Enhancer parameters.

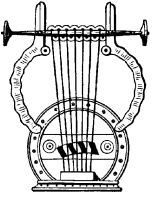

## Dynamic Filter

The Dynamic Filter stage is similar to the dynamic filters found in many conventional synthesizers. It allows both fixed and dynamic filtering in high-pass, low-pass, bandpass, and band elimination modes, and is effective for broad tonal control.

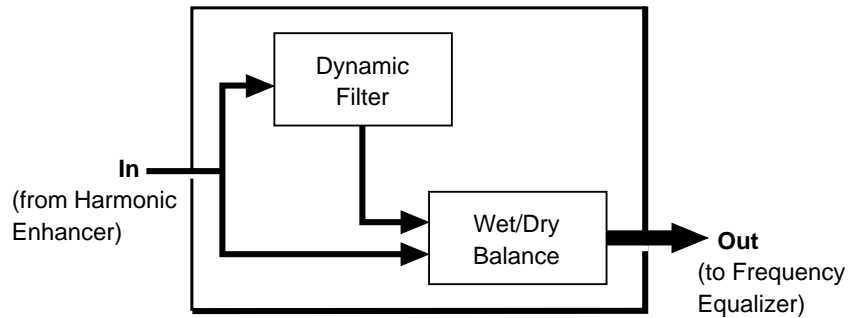

### ■ The Dynamic Filter Parameter Page

```

EDIT/E1/MODIFIER/DYNAMIC FILTER
BA02(002):Tenor Sax /E1:Tenor Sax
Filter Mode = [ ] Input Gain = 127
Balance = -1 Dry [ ] Wet [ ]
Cutoff Tracking = KeyTrack
Cutoff Freq. = 2.19oct
Resonance = 1.000
Ctrl
  
```

The dry/wet “Balance” parameter allows delicate variations in the degree of filtration applied. The “Cutoff Tracking” parameter selects either the “Fixed” mode in which the cutoff frequency of the filter is fixed at the specified cutoff frequency in Hz (“Cutoff Freq.” parameter), or the “KeyTrack” mode in which the cutoff frequency varies according to the key played. When “KeyTrack” is selected the cutoff frequency is specified in octaves. Another important feature is “Resonance” — a parameter that produces a variable resonant peak at the specified cutoff frequency in any of the filter’s modes.

**NOTES** ■ Refer to page 115 of the Feature Reference manual for full details on the Dynamic Filter parameters.

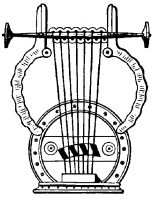

## Frequency Equalizer

The Frequency Equalizer stage consists of two blocks — Auxiliary and Band — each with its own display page.

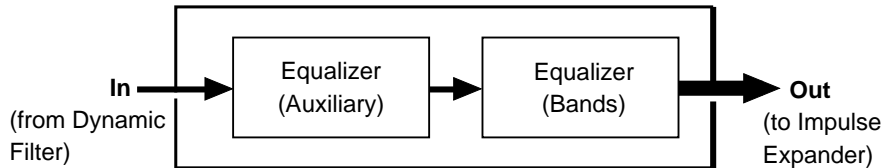

### ■ The Equalizer Auxiliary Parameter Page

```

EDIT/E1/MODIFIER/EQUALIZER AUXILIARY
BA02(002):Tenor Sax /E1:Tenor Sax
Input Gain = 1.0
HPF Cutoff Freq. = 17.0 Hz
LPF Cutoff Freq. = 24.0 kHz
  
```

### ■ The Equalizer Band Parameter Page

```

EDIT/E1/MODIFIER/EQUALIZER BAND
BA02(002):Tenor Sax /E1:Tenor Sax
Bnd1: Freq=208.0 Hz Q=0.50 Level= 11.3
Bnd2: =838.0 Hz =0.97 = 10.5
Bnd3: =321.0 Hz =0.75 = 10.5
Bnd4: =2.83 kHz =0.63 = 7.9
Bnd5: =5.44 kHz =0.50 = 8.6
  
```

The Auxiliary block includes programmable low-pass and high-pass filters that can be used independently or together to create a bandpass response. Both the low-pass and high-pass filters have independent key-scaling parameters that can be used to vary the gain of the filters across the range of the keyboard. The “Input Gain” parameter adjusts the level of the signal applied to the input of the Equalizer Auxiliary stage.

The Equalizer Band block is a 5-band parametric equalizer with frequency, Q (bandwidth), and level control. The Band block functions in the same way as any standard parametric equalizer, allowing flexible response control over a wide range.

**NOTES** ■ Refer to page 122 of the Feature Reference manual for full details on the Frequency Equalizer parameters.



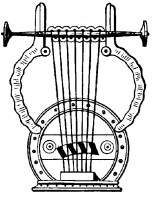

## Impulse Expander

The Impulse Expander works in conjunction with the Resonator, described below, to simulate the effect of an instrument's resonant cavity or sound box. It can also be used to simulate the acoustic environment in which the instrument is played.

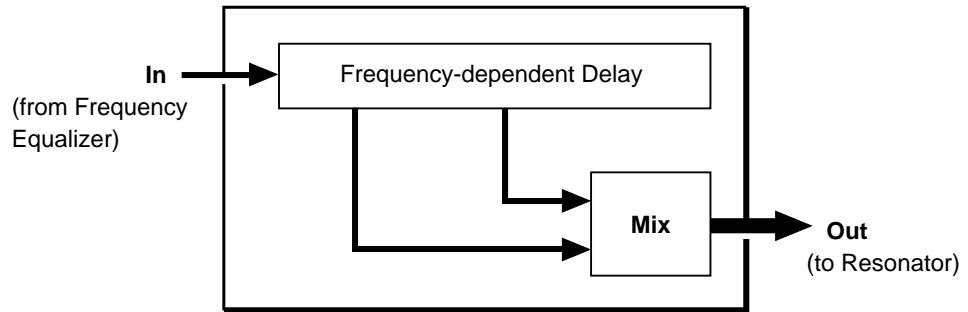

### ■ The Impulse Expander Parameter Page

```

EDIT/E1/MODIFIER/IMPULSE EXPANDER
BA02(002):Tenor Sax /E1:Tenor Sax
Density = 9.521msec
Dispersion = 7.080msec
Roughness = 0
Set
  
```

In contrast to the Resonator, the Impulse Expander is more suited to the simulation of metallic resonances and is thus invaluable for refining the sound of brass and metal-bodied woodwinds. Other important effects are the ability to diffuse sharp attack sounds and to give depth and realism to vibrato. In fact, the Impulse Expander should only be used with voices which have a degree of vibrato or other cyclic variation, since its effect is less noticeable on uniformly sustained sounds.

Since the Impulse Expander is not essential for all voices, it can be turned completely off when not needed. It also has “Wet Level”, “Dry Level”, and stereo “Level Balance” parameters that allow its effect to be blended into the main sound as required.

**NOTES** ■ Refer to page 125 of the Feature Reference manual for full details on the Impulse Expander parameters.

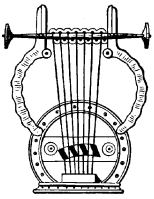

## Resonator

While the Impulse Expander tends to give the sound a metallic quality, the Resonator produces a more woody resonance effect. Careful adjustment of the resonator's parameters can often bring a not-quite-right voice to life.

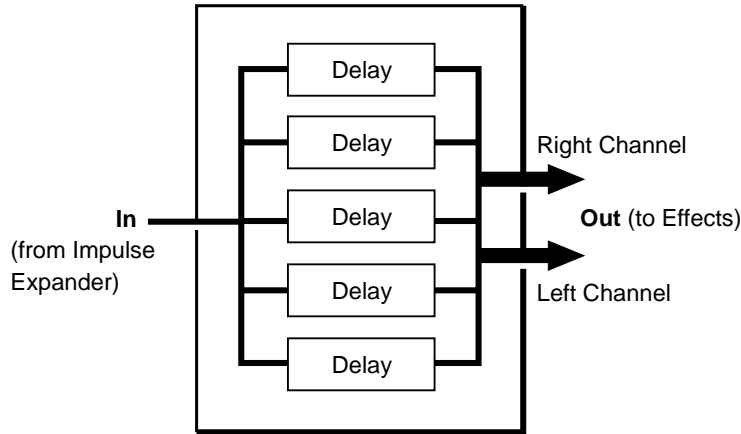

### ■ The Resonator Parameter Page

```

EDIT/E1/MODIFIER/RESONATOR
BA02(002):Tenor Sax /E1:Tenor Sax
DL1 | DL2 | DL3 | DL4 | DL5
26.25 27.21 33.79 34.96 41.54[msec]
Decay Time = 106.1msec
LPF Cutoff Freq. = 5.84 kHz
Diffusion = 16 Phase = 0
Set
    
```

The Resonator basically consists of five parallel delay lines with independently programmable delay times (DL1 through DL5, variable from 0.25 to 41.45 milliseconds). Other parameters include variable “Decay Time”, “LPF Cutoff Freq.” (low-pass filtercutoff frequency), “Diffusion”, and “Phase”.

Like the Impulse Expander, the Resonator is not essential for all voices and can be turned completely off when not needed. It also has “Input Gain”, “Wet Level”, and stereo “Level Balance” parameters that allow its effect to be blended into the main sound as required (the cursor is moved around the block diagram in the “IE & RSN SETTING” page, shown below, to select the parameters associated with the various blocks).

### ■ The Impulse Expander & Resonator Setting Page (IE = Impulse Expander, RSN = Resonator)

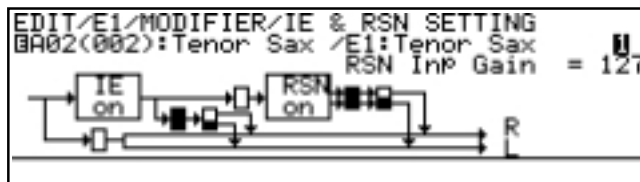

**NOTES** ■ Refer to page 126 of the Feature Reference manual for full details on the Resonator parameters.

# Effects

*Creating the Right Ambience*



Effects are the essential finishing touches for any voice. Once you've created a sound you like, use one or more of the VL1's three high-performance digital effect stages to polish and refine it as required. Each stage includes a number of effects. The Modulation, Feedback Delay, and Reverb stages can be used simultaneously, but only one of the effects available in each stage can be used at a time.

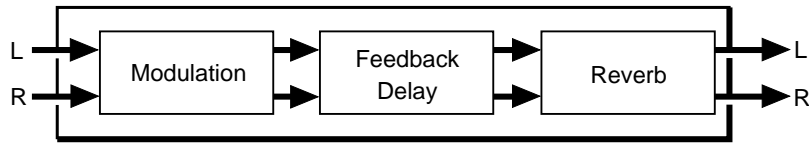

All effects can be accessed from the initial EDIT mode display by press the **[F1]** button (“Com”) to select the common voice parameters, and then the **[F2]** button (“Efect”) to call the effect directory. Then move the cursor to the name of the desire effect stage and press **[ENTER]** button.



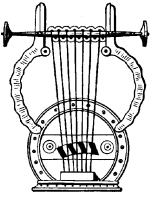

## Modulation Effects

Although “modulation” usually implies some sort of cyclical variation, the VL1 Modulation stage allows selection of Flanger, Pitch Change, and Distortion effects (only Flanger fits the traditional definition of a modulation effect). Since most of these effects produce a marked change in the sound, you’ll probably only want to use them on certain voices, and maybe not all the time.

<b>Flanger</b>	This type of effect is created by slightly delaying the sound and periodically varying the delay time. The delayed signal is then added to the direct signal causing a variable comb-filter effect which results in the familiar “swishing” flanger sound.
<b>Pitch Change</b>	A dual pitch change effect which can be used in the Mono mode, in which both pitch-shifted notes appear on both channels, or the Stereo mode in which one pitch-shifted note appears on the left channel and the other on the right. The pitch of the two pitch-shifted notes can be set over a two-octave range — from one octave below to one octave above the input note.
<b>Distortion</b>	An extremely versatile distortion effect which offers transistor, vintage tube, fuzz and other distortion types, a variety of speaker types, and a comprehensive range of other parameters that can be used to refine the distortion sound.

**NOTES** ■ Refer to page 46 of the Feature Reference manual for full details on the Modulation effects and parameters.

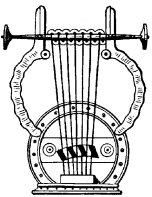

## Feedback Delay Effects

All three effects available in the Feedback Delay stage are basically designed to produce distinct repeat delays or echoes. You have extensive control over the number of repeats produced and the way they decay.

<b>Mono</b>	The Mono delay effect produces a single delay sound which appears in the center of the stereo sound field.
<b>L, R</b>	This variation provides independently programmable delays for the left and right stereo channels.
<b>L, C, R</b>	Independent delays are provided for the left and right channels, plus a center delay.

Since the goal in producing a delay effect is often to match the delay time to a musical time value, the VL1 includes a “time calculation” function that makes it easy to convert standard note values to their corresponding delay times in milliseconds.

### ■ The Time Calculation Pop-up Page

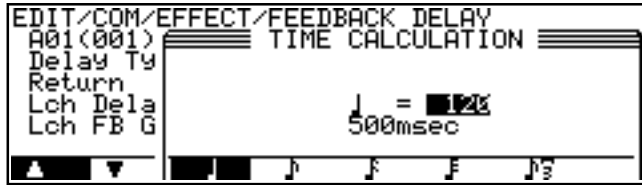

**NOTES** ■ Refer to page 53 of the Feature Reference manual for full details on the Feedback Delay effects and parameters.

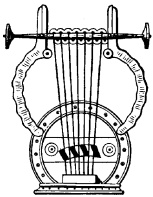

## Reverb Effects

You'll probably want to apply the effects in this stage to some degree to all your voices. These are the effects that will give your sound ambience and a sense of dimension, adding warmth and depth to an otherwise dry sound.

<b>Hall 1</b>	A simulation of the reverberation characteristics of a fairly standard concert hall.
<b>Hall 2</b>	This hall simulation produces a richer low-frequency reverb sound than the Hall 1 program.
<b>Room 1</b>	The ambience of a small room rather than a large hall. This effect is ideal when you just want a subtle touch of ambience.
<b>Room 2</b>	A larger room than the Room 1 simulation, with a correspondingly "bigger" reverb sound.
<b>Studio</b>	In recording studios it is generally desirable to suppress low-frequency reverberation without entirely losing the "live" sound of the room. The Studio program simulates this type of environment.
<b>Plate</b>	The plate reverb unit is a classic tool of the recording trade — it was the first mechanical method of creating artificial reverberation that was capable of producing satisfactory results in the studio. This is a very realistic simulation.
<b>Space</b>	A diffuse reverberation of the type you might experience in an extremely large space.
<b>Reverse</b>	In this effect the reverb sound plays in reverse, building up to maximum level rather than decaying as normal.

For even more versatility all of the reverb effects have a "Feel" parameter with four settings which produce significant changes in the basic sound of the effect. In essence you have 32 distinct reverb programs (8 effects x 4 Feel settings). Another innovative feature of the reverb effects is a Reverb Time Boost parameter which can be used to extend the tail end of the reverb sound in fine increments.

**NOTES** ■ Refer to page 60 of the Feature Reference manual for full details on the Reverb effects and parameters.



# Index



This index covers both the VL1 *Getting Started* and *Feature Reference* manuals for easy cross-referencing. Page numbers in the *Getting Started* manual are preceded by “GS”, and page numbers in the *Feature Reference* manual are preceded by “FR”.

## A

Absorption	FR 81
Aftertouch curve	FR 157
Amplitude & filter envelope	FR 143
Amplitude & filter key scaling	FR 146-150
Amplitude	FR 71
Assign mode	FR 35

## B

Backup battery	GS 4
Bank buttons	GS 19, 34. FR 15
Breath attack gain	FR 36
Breath attack time	FR 36
Breath control curve	FR 157
Breath controller calibration	GS 29
Breath controller	GS 23
Breath controller jack	GS 19
Breath noise	FR 73, 86
Breath noise key scaling	FR 88-90
Bulk dump, MIDI	FR 161

## C

Common miscellaneous	FR 34
Confirm mode	FR 158
Continuous slider assignment	FR 43
Continuous sliders	GS 18, 47. FR 19
Controller envelopes	GS 46
Controller search & replace	FR 82
Controller parameters	GS 40
Controller views	GS 41, 47. FR 17
Controllers	GS 12, 38

Conventions	GS 7
Copy button	GS 17
Copy function	FR 25
Crossfade speed	FR 85
Cursor buttons	GS 18

## D

Damping	FR 80
Data dial	GS 18, 35. FR 16
Decrement & increment buttons	GS 18, 35. FR 16
Demo playback	GS 26. FR 175
Device number	FR 155
Disk format	FR 171
Disk status	FR 163
Disk, delete file	FR 170
Disk, load from	FR 164
Disk, rename file	FR 168
Disk, save to	FR 166
Display mode	FR 158
Distortion	FR 51
Dynamic filter	GS 54. FR 77, 115
Dynamic filter key scaling	FR 117-118

## E

Edit compare function	FR 24
Edit recall	FR 173
Effect control	FR 45
Effect on/off	FR 23
Effects	GS 58
Element detune	FR 37
Element level	FR 38
Element names	FR 31
Element note shift	FR 37



Element on/off **FR** 22  
 Element pan **FR** 38  
 Element random pitch **FR** 37  
 Element select **FR** 22  
 Embouchure & pitch envelope **FR** 130  
 Embouchure & pitch envelope key scaling **FR** 132-134  
 Embouchure **FR** 66  
 Enter button **GS** 18  
 Equalizer auxiliary **FR** 119  
 Equalizer band **FR** 122  
 Equalizer **GS** 55  
 Equalizer key scaling **FR** 120-121  
 Error messages **FR** 180  
 Exit button **GS** 18

**F**

Feedback delay effects **GS** 59  
 Feedback delay **FR** 53  
 Feedback delay/reverb mode **FR** 45  
 Flanger **FR** 47  
 Floppy disk drive **GS** 19  
 Floppy disks & drive, handling **GS** 5  
 Foot controller 2 assign **FR** 156  
 Foot controller jacks **GS** 20  
 Foot controllers **GS** 23  
 Foot switches **GS** 23  
 Foot switch assign **FR** 156  
 Foot switch jacks **GS** 20  
 Function buttons **GS** 18  
 Functions & parameters, finding **FR** 9

**G**

Greeting message **FR** 158  
 Growl envelope **FR** 141  
 Growl **FR** 74  
 Growl speed key scaling **FR** 142

**H**

Harmonic enhancer **GS** 51. **FR** 78, 107  
 Harmonic enhancer key scaling **FR** 110-115  
 Headphones **GS** 23

**I**

Impulse expander & resonator setting **FR** 123  
 Impulse expander **GS** 56. **FR** 125  
 Initial edit page **FR** 30  
 Interpolate speed **FR** 85

**K**

Key mode **FR** 31  
 Keyboard **GS** 19  
 Keyboard transpose **FR** 153

**L**

L,C,R delay **FR** 57  
 L,R delay **FR** 55  
 LCD display **GS** 18  
 Local on/off **FR** 155

**M**

Manuals, about the **GS** 6. **FR** 4  
 Master tuning **FR** 154  
 Memory protect **FR** 158  
 Micro tuning **FR** 42  
 MIDI connections **GS** 24  
 MIDI connectors **GS** 20  
 MIDI settings **FR** 155  
 Mixing **GS** 48. **FR** 98  
 Mixing key scaling **FR** 100-105  
 Mode buttons **GS** 17  
 Modes, the 3 main **FR** 8  
 Modifier on/off **FR** 23  
 Modifiers **GS** 51  
 Modulation effect type **FR** 46  
 Modulation effects **GS** 59  
 Modulation wheel 2 assign **FR** 156  
 Modulation wheels **GS** 19  
 Mono delay **FR** 53

**N**

Navigation aids **FR** 11

**O**

Octave buttons **GS** 19  
 Octave switch hold **FR** 153  
 Output jacks **GS** 20



**P**

Phones jack	<b>GS</b> 19
Pitch bend mode	<b>FR</b> 35
Pitch change	<b>FR</b> 49
Pitch	<b>FR</b> 67
Pitch wheel	<b>GS</b> 19
Play-mode display	<b>GS</b> 34. <b>FR</b> 14
Polyphony control	<b>FR</b> 36
Portamento	<b>FR</b> 40
Power cord socket	<b>GS</b> 20
Power supply	<b>GS</b> 22
Power switch	<b>GS</b> 20
Power-on procedure	<b>GS</b> 25
Pre-programmed voices, loading	<b>GS</b> 31
Pressure envelope	<b>FR</b> 129
Pressure	<b>FR</b> 65

**Q**

Quick editing	<b>FR</b> 19
---------------	--------------

**R**

Receive channel	<b>FR</b> 155
Resonator	<b>GS</b> 57. <b>FR</b> 126
Reverb effects	<b>GS</b> 60
Reverb	<b>FR</b> 60

**S**

Scream	<b>FR</b> 72
Selecting & editing parameters	<b>FR</b> 12
Sound system	<b>GS</b> 24
Specifications	<b>FR</b> 184
Store button	<b>GS</b> 17
Store function	<b>FR</b> 28
Sustain	<b>FR</b> 35

**T**

Throat formant	<b>FR</b> 75, 91
Throat formant key scaling	<b>FR</b> 93-97
Time calculation, musical	<b>FR</b> 59
Tonguing	<b>FR</b> 70
Touch EG time	<b>FR</b> 36
Transmit channel	<b>FR</b> 155
Trigger mode	<b>FR</b> 85
Troubleshooting	<b>FR</b> 178

**V**

Velocity curve	<b>FR</b> 157
Vibrato envelope	<b>FR</b> 135
Vibrato envelope key scaling	<b>FR</b> 137-140
Vibrato	<b>FR</b> 69
Voice directory	<b>GS</b> 36
Voice list, abbreviated	<b>GS</b> 37
Voice mode	<b>FR</b> 32
Voice name	<b>FR</b> 31
Voice number buttons	<b>GS</b> 19, 34. <b>FR</b> 15, 22
Voice selection	<b>GS</b> 34. <b>FR</b> 15
Volume control	<b>GS</b> 18



**YAMAHA**  
YAMAHA CORPORATION  
P.O.Box 1, Hamamatsu, Japan