



DRUM TRIGGER MODULE

DTXPRESS IV

OWNER'S MANUAL



SPECIAL MESSAGE SECTION

This product utilizes batteries or an external power supply (adapter). DO NOT connect this product to any power supply or adapter other than one described in the manual, on the name plate, or specifically recommended by Yamaha.

WARNING: Do not place this product in a position where anyone could walk on, trip over, or roll anything over power or connecting cords of any kind. The use of an extension cord is not recommended! If you must use an extension cord, the minimum wire size for a 25' cord (or less) is 18 AWG. NOTE: The smaller the AWG number, the larger the current handling capacity. For longer extension cords, consult a local electrician.

This product should be used only with the components supplied or; a cart, rack, or stand that is recommended by Yamaha. If a cart, etc., is used, please observe all safety markings and instructions that accompany the accessory product.

SPECIFICATIONS SUBJECT TO CHANGE:

The information contained in this manual is believed to be correct at the time of printing. However, Yamaha reserves the right to change or modify any of the specifications without notice or obligation to update existing units.

This product, either alone or in combination with an amplifier and headphones or speaker/s, may be capable of producing sound levels that could cause permanent hearing loss. DO NOT operate for long periods of time at a high volume level or at a level that is uncomfortable. If you experience any hearing loss or ringing in the ears, you should consult an audiologist.

IMPORTANT: The louder the sound, the shorter the time period before damage occurs.

Some Yamaha products may have benches and / or accessory mounting fixtures that are either supplied with the product or as optional accessories. Some of these items are designed to be dealer assembled or installed. Please make sure that benches are stable and any optional fixtures (where applicable) are well secured BEFORE using.

Benches supplied by Yamaha are designed for seating only. No other uses are recommended.

NOTICE:

Service charges incurred due to a lack of knowledge relating to how a function or effect works (when the unit is operating as designed) are not covered by the manufacturer's warranty, and are therefore the owners responsibility. Please study this manual carefully and consult your dealer before requesting service.

ENVIRONMENTAL ISSUES:

Yamaha strives to produce products that are both user safe and environmentally friendly. We sincerely believe that our products and the production methods used to produce them, meet these goals. In keeping with both the letter and the spirit of the law, we

want you to be aware of the following:

Battery Notice:

This product MAY contain a small non-rechargeable battery which (if applicable) is soldered in place. The average life span of this type of battery is approximately five years. When replacement becomes necessary, contact a qualified service representative to perform the replacement.

This product may also use "household" type batteries. Some of these may be rechargeable. Make sure that the battery being charged is a rechargeable type and that the charger is intended for the battery being charged.

When installing batteries, do not mix batteries with new, or with batteries of a different type. Batteries MUST be installed correctly. Mismatches or incorrect installation may result in overheating and battery case rupture.

Warning:

Do not attempt to disassemble, or incinerate any battery. Keep all batteries away from children. Dispose of used batteries promptly and as regulated by the laws in your area. Note: Check with any retailer of household type batteries in your area for battery disposal information.

Disposal Notice:

Should this product become damaged beyond repair, or for some reason its useful life is considered to be at an end, please observe all local, state, and federal regulations that relate to the disposal of products that contain lead, batteries, plastics, etc. If your dealer is unable to assist you, please contact Yamaha directly.

NAME PLATE LOCATION:

The name plate is located on the bottom of the product. The model number, serial number, power requirements, etc., are located on this plate. You should record the model number, serial number, and the date of purchase in the spaces provided below and retain this manual as a permanent record of your purchase.

Model

Serial No.

Purchase Date

PLEASE KEEP THIS MANUAL

Introduction

Thank you for purchasing the YAMAHA DTXPRESS IV.

The DTXPRESS IV is a compact drum trigger module that includes a wealth of rich, high-quality drum voices and is compatible with snare pads equipped with a pad controller. It also has a comprehensive variety of features that help you build your drumming and rhythm section skills, a built-in sequencer for recording your own songs and performances, an effective Groove Check function that helps you tighten your timing, and a versatile, multi-function metronome for enhancing your practice sessions. Moreover, it provides a large selection of preset songs that you can play along with and improve your ability in a variety of musical styles.

To get the most out of your DTXPRESS IV, please read this manual carefully. After reading through the manual, make sure to store it in a safe place so that you can refer back to it again as needed.

Accessories

- Yamaha AC power adaptor (PA-3C)*
- Module stand
- Module stand fastening screws x 2
- Owner's Manual (this book)

* May not be included depending on your particular area. Please check with your Yamaha dealer.

About the Descriptions and Conventions in this Manual

- [DRUM KIT], [CLICK], etc.
Panel buttons and controls are indicated with [] (brackets).
- [SHIFT] + [DRUM KIT], etc.
This means to simultaneously hold down the [SHIFT] button and press the [DRUM KIT] button.
- [◀]/[▶], etc.
This means that you can use either the [◀] button or [▶] button in the operation.
- “Completed!”, etc.
Words in quotation marks indicate a message shown on the LCD display.

The illustrations and LCD screens as shown in this owner's manual are for instructional purposes only, and may appear somewhat different from those on your instrument.

■ About the pads

This Owner's Manual described the model names of the drum pads which can be connected to the DTXPRESS IV. Note that these were the latest models at the time this Owner's Manual was produced. For details about more recently released models, refer to the following website.

<http://www.yamaha.co.jp/english/product/drums/ed/>

PRECAUTIONS

PLEASE READ CAREFULLY BEFORE PROCEEDING

* Please keep this manual in a safe place for future reference.



WARNING

Always follow the basic precautions listed below to avoid the possibility of serious injury or even death from electrical shock, short-circuiting, damages, fire or other hazards. These precautions include, but are not limited to, the following:

Power supply/AC power adaptor

- Only use the voltage specified as correct for the instrument. The required voltage is printed on the name plate of the instrument.
- Use the specified adaptor (PA-3C, PA-130 or an equivalent recommended by Yamaha) only. Using the wrong adaptor can result in damage to the instrument or overheating.
- Check the electric plug periodically and remove any dirt or dust which may have accumulated on it.
- Do not place the AC adaptor cord near heat sources such as heaters or radiators, and do not excessively bend or otherwise damage the cord, place heavy objects on it, or place it in a position where anyone could walk on, trip over, or roll anything over it.

Do not open

- Do not open the instrument or attempt to disassemble the internal parts or modify them in any way. The instrument contains no user-serviceable parts. If it should appear to be malfunctioning, discontinue use immediately and have it inspected by qualified Yamaha service personnel.

Water warning

- Do not expose the instrument to rain, use it near water or in damp or wet conditions, or place containers on it containing liquids which might spill into any openings. If any liquid such as water seeps into the instrument, turn off the power immediately and unplug the power cord from the AC outlet. Then have the instrument inspected by qualified Yamaha service personnel.
- Never insert or remove an electric plug with wet hands.

Fire warning

- Do not put burning items, such as candles, on the unit.
A burning item may fall over and cause a fire.

If you notice any abnormality

- If the AC adaptor cord or plug becomes frayed or damaged, or if there is a sudden loss of sound during use of the instrument, or if any unusual smells or smoke should appear to be caused by it, immediately turn off the Standby/On switch, disconnect the adaptor plug from the outlet, and have the instrument inspected by qualified Yamaha service personnel.



CAUTION

Always follow the basic precautions listed below to avoid the possibility of physical injury to you or others, or damage to the instrument or other property. These precautions include, but are not limited to, the following:

Power supply/AC power adaptor

- When removing the electric plug from the instrument or an outlet, always hold the plug itself and not the cord.
- Unplug the AC power adaptor when not using the instrument, or during electrical storms.
- Do not connect the instrument to an electrical outlet using a multiple-connector. Doing so can result in lower sound quality, or possibly cause overheating in the outlet.

Location

- Do not expose the instrument to excessive dust or vibrations, or extreme cold or heat (such as in direct sunlight, near a heater, or in a car during the day) to prevent the possibility of panel disfiguration or damage to the internal components.

- Do not use the instrument in the vicinity of a TV, radio, stereo equipment, mobile phone, or other electric devices. Otherwise, the instrument, TV, or radio may generate noise.
- Do not place the instrument in an unstable position where it might accidentally fall over.
- Before moving the instrument, remove all connected adaptor and other cables.
- When setting up the product, make sure that the AC outlet you are using is easily accessible. If some trouble or malfunction occurs, immediately turn off the Standby/On switch and disconnect the plug from the outlet. Even when the Standby/On switch is turned off, electricity is still flowing to the product at the minimum level. When you are not using the product for a long time, make sure to unplug the power cord from the wall AC outlet.
- Use only the stand/rack specified for the instrument. When attaching the stand or rack, use the provided screws only. Failure to do so could cause damage to the internal components or result in the instrument falling over.
- Do not place objects in front of the instrument's air vent, since this may prevent adequate ventilation of the internal components, and possibly result in the instrument overheating.

Connections

- Before connecting the instrument to other electronic components, turn off the power for all components. Before turning the power on or off for all components, set all volume levels to minimum. Also, be sure to set the volumes of all components at their minimum levels and gradually raise the volume controls while playing the instrument to set the desired listening level.

Maintenance

- When cleaning the instrument, use a soft, dry cloth. Do not use paint thinners, solvents, cleaning fluids, or chemical-impregnated wiping cloths.

Handling caution

- Never insert or drop paper, metallic, or other objects into the gaps on the panel. If this happens, turn off the power immediately and unplug the power cord from the AC outlet. Then have the instrument inspected by qualified Yamaha service personnel.
- Do not place vinyl, plastic or rubber objects on the instrument, since this might discolor the panel.

- Do not rest your weight on, or place heavy objects on the instrument, and do not use excessive force on the buttons, switches or connectors.
- Do not use the instrument/device or headphones for a long period of time at a high or uncomfortable volume level, since this can cause permanent hearing loss. If you experience any hearing loss or ringing in the ears, consult a physician.

Saving data

- Never attempt to turn off the power while data is being written to Flash ROM (while a "now storing..." message is shown). Turning the power off in this state results in loss of all user data and may cause the system to freeze (due to corruption of data in the Flash ROM). This means that this instrument may not be able to start up properly, even when turning the power on next time.

Yamaha cannot be held responsible for damage caused by improper use or modifications to the instrument, or data that is lost or destroyed.

Always turn the power off when the instrument is not in use.

Even when the Standby/On switch is in the standby position, electricity is still flowing to the instrument at the minimum level. When you are not using the instrument for a long time, make sure you unplug the AC power adaptor from the wall AC outlet.

- *This product incorporates and bundles computer programs and contents in which Yamaha owns copyrights or with respect to which it has license to use others' copyrights. Such copyrighted materials include, without limitation, all computer software, style files, MIDI files, WAVE data, musical scores and sound recordings. Any unauthorized use of such programs and contents outside of personal use is not permitted under relevant laws. Any violation of copyright has legal consequences. DONT MAKE, DISTRIBUTE OR USE ILLEGAL COPIES.*
- *Copying of the commercially available musical data including but not limited to MIDI data and/or audio data is strictly prohibited except for your personal use.*
- *The company names and product names in this Owner's Manual are the trademarks or registered trademarks of their respective companies.*

Main Features

The DTXPRESS IV is equipped with a high-quality 32-polyphony tone generator that produces realistic voices, includes a high-performance, multi-function metronome, a built-in sequencer and a variety of songs—all combined into a compact, portable package. The DTXPRESS IV is an exceptionally versatile instrument that can be used in a variety of situations such as live performance, personal practice, and much more.

■ Drum Triggers

- Built into the unit are twelve trigger input jacks and a hi-hat controller jack. The instrument also features jacks that are compatible with two-zone or three-zone pads (pads that transmit different signals depending on the area that is hit). Moreover, the snare drum jack is compatible with pad-controller-equipped pads. This lets you adjust the ‘virtual’ snares and the tuning—just as you would with an acoustic snare drum. All in all, the DTXPRESS IV has the operability, functionality and performance that is virtually equivalent to an acoustic drum kit.
- You can connect the DTXPRESS IV to an acoustic drum kit by using drum triggers such as Yamaha DT20. The setup data such as the trigger input types and sensitivity can be customized to suit your playing preferences, style and particular setup.
- Also included in the unit are 50 preset drum kits which naturally contain acoustic drum kits, and cover a wide range of music genres, such as rock, funk, jazz, reggae, Latin, etc. Moreover, User kit memory is available for storing 20 sets. With this, you can set up your own original drum kits using the various drum voices.

**The word “trigger” refers to the means by which hitting a pad sends a signal to the DTXPRESS IV as to what sound to play on the built-in tone generator and how loud the sound should be played.*

■ Tone Generator

- The DTXPRESS IV is equipped with a high-quality, 16-bit AWM2 (PCM) tone generator with 32-voice polyphony that produces dynamic voices or exceptional realism. The voices—totalling 427—cover a wide range sounds, such as authentic acoustic drums, unique electronic percussion, sound effects, and much more. The instrument also features a built-in high-quality digital reverb for enhancing the sound.

■ High-performance Metronome

- The DTXPRESS IV provides with a comprehensive, multi-function metronome, allowing various click settings for each note value. Each note value can be assigned its own separate click sound and pitch. You can also set a timer that will determine when the click stops and set breaks which how many measures the click will play and then be muted.
- The DTXPRESS IV also features a “Tap” function that lets you set the tempo for the song or click by tapping in tempo on a pad to any tempo you like. This lets you set whatever tempo you desire for playing or practicing.

■ Sequencer

- The built-in sequencer contains a wide variety of 63 preset songs. Two functions that make the DTXPRESS IV great for practice are the Drum Mute Function, which mutes a specific drum part, and the Bass Solo function, which lets you play along with just the song’s bass part. The DTXPRESS IV also allows you to record your performance in real time—and allows you to play along with your recorded performance data.
- In addition to one main song that is controlled from the panel, three pad songs can be individually controlled and simultaneously played by trigger input from the pads.

■ Groove Check

- The Groove Check function monitors your playing and provides instant feedback on your rhythmic skills, providing a powerful way to quickly improve your technique. It includes a Rhythm Gate function that produces sounds only if your timing is accurate, and also has a Challenge mode that evaluates your playing, giving you a letter grade—and makes mastering the drums easier and more fun than ever before.

■ Interface

- A MIDI OUT jack on the rear panel lets you connect other devices and play sounds from an external tone generator or synchronize the metronome with an external sequencer. Also provided are an AUX IN jack, which lets you plug in and play along with an external audio device, such as a CD player or MD player, and a headphones jack for convenient practice without disturbing others.

Contents

Introduction	3	5 Using the Groove Check Function	24
Accessories	3	Groove Check Mode	24
About the Descriptions and Conventions in this Manual	3	6 Record Your Performance.....	26
Main Features	6	Recording System	26
Controls and Functions.....	8	7 Create Your Own Original Drum Kit	28
Top Panel	8	Factory Set	35
Rear Panel	9	8 Trigger Setup Edit	36
1 Connections	10	Trigger Setup procedure	36
1 Connecting the Pads	10	Explanations of Each Display Page	37
DTXPRESS IV Standard Set.....	10	Error Messages	40
DTXPRESS IV Special Set	11	Troubleshooting	40
Setting up with Acoustic Drums.....	11	Index	42
2 Setting Up the Power Supply.....	12	Appendix.....	43
3 Connecting to Speakers or Headphones.....	12	MIDI Data Format	43
4 Turning the Power On.....	13	LCD Displays	44
5 Selecting the Trigger Setup	14	MIDI Implementation Chart.....	47
2 Time to Play.....	15	Drum Voice List	48
Adjusting the Hi-hat.....	16	Preset Drum Kit List.....	49
Pad Controller Settings	17	Preset Song List	49
3 Playing Along With the Click	18	Specifications.....	50
Click Out Select.....	20		
Tap Tempo Function	21		
LED Display Setting	21		
4 Playing Along With a Song	22		
Pad Function Settings	23		

Controls and Functions

Top Panel

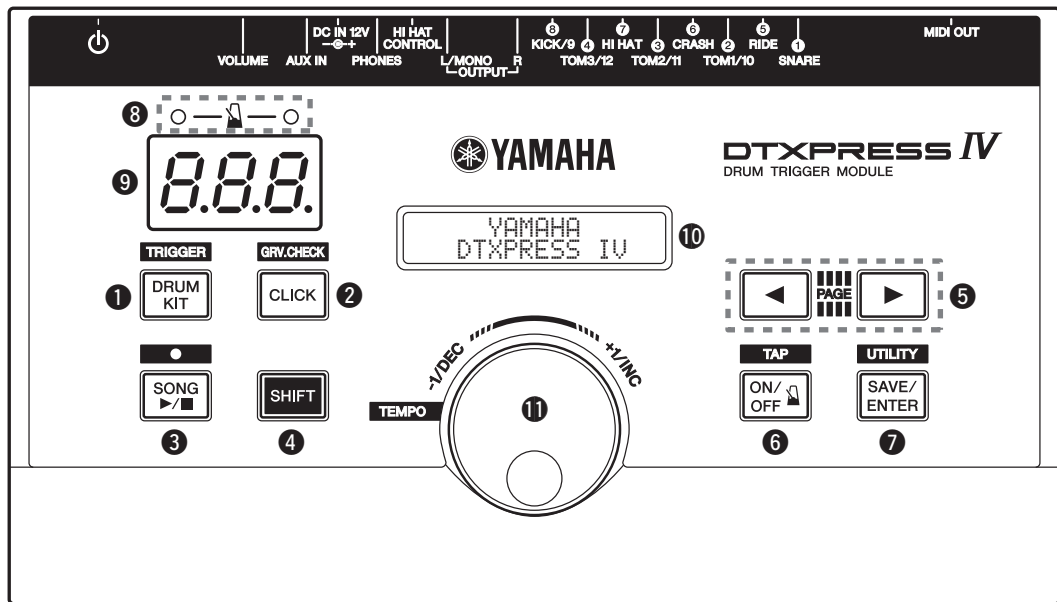

1 Drum Kit button (DRUM KIT)

- For entering the Drum Kit Select display. (p. 15)
- Hold the [SHIFT] button and press the [DRUM KIT] button to enter the Trigger Setup Select page. (p. 14)
- This button can also be used to temporarily mute all sounds of all voices.

2 Click button (CLICK)

- For entering the Click (Metronome) Setting page. (p. 18)
- Hold the [SHIFT] button and press the [CLICK] button to enter the Groove Check Setting display. (p. 24)

3 Song button (SONG ►/■)

- For entering the Song Select page. (p. 22)
- Hold the [SHIFT] button and press the [SONG ►/■] button to enable recording standby mode for the DTXPRESS IV.
- Press this button to start/stop song playback or recording.

4 Shift button (SHIFT)

Holding this button and pressing another specific button switches to the function printed above each button on the top panel.

5 Select buttons (◀, ▶)

- For selecting an item you want to edit (the selected item flashes). If there are multiple pages either before or after the page currently displayed, the buttons are used to view the next or previous page. Hold the button to continuously move the flashing cursor.
- Press these two buttons together to scroll continuously back and forth through the pages. Holding the [◀] button first and pressing the [▶] button moves to the previous page while holding the [▶] button first and pressing the [◀] button moves to the next.
- Hold the [SHIFT] button and press the [◀]/[▶] buttons to select the trigger input you want to edit.

6 Click ON/OFF button (ON/OFF)

- For starting/stopping the click sound (metronome). (p. 18)
- Hold the [SHIFT] button and press the [ON/OFF] button to enter the Tap Tempo Setting page. (p. 21)

7 Save/Enter button (SAVE/ENTER)

- For saving data or executing an operation (Enter).
- Hold the [SHIFT] button and press the [SAVE/ENTER] button to enter the Utility page, which is used to make overall settings for operating the DTXPRESS IV.

8 Click lamp

The red lamp lights on the first beat of every measure when the click or a song is playing. The other beats are indicated with a green light.

9 LED display

For indicating the tempo, the number selected in the current page, or the click timer depending on the setting made. (p. 21)

10 LCD display

For displaying important information and data used in operating the DTXPRESS IV.

11 Jog dial

Rotate the jog dial to change the value selected with the cursor (the flashed item to be edited) in the display. Rotate the dial to the right (clockwise) to increase the value, and to the left to decrease. The jog dial can also be used to change the layer (A/B) and for Drum mute.

Hold the [SHIFT] button and rotate the knob to change the current tempo.

Rear Panel

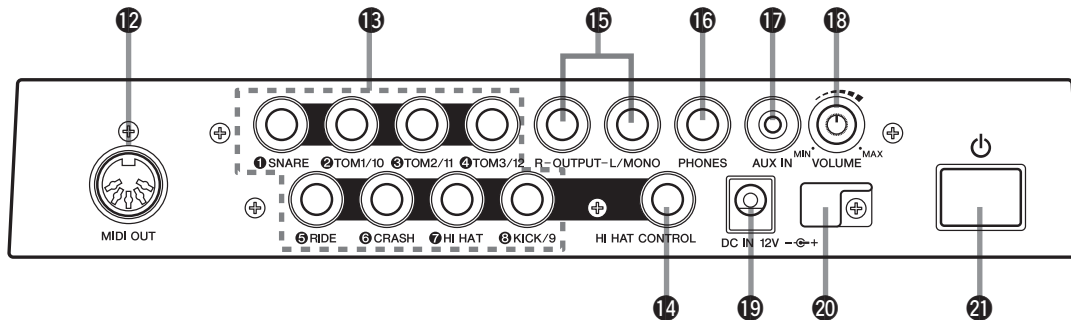

12 MIDI OUT jack

For sending data from the DTXPRESS IV to an external MIDI device. With this jack, you can use the DTXPRESS IV as a control device to trigger voices from an external tone generator, or synchronize song playback or the click of the DTXPRESS IV with the playback of an external sequencer. (p. 13)

13 Trigger Input jacks (1 SNARE thru 8 KICK/9)

For connecting pads or drum triggers (Yamaha DT20, etc.) to receive trigger signals.

Connect external pads such as a snare, tom, etc., according to the indication below each input. (p. 10, 11)

① SNARE Compatible with three-zone pads and the pad controller.

② TOM1/10, ③ TOM2/11, ④ TOM3/12, ⑧ KICK/9
 Mono x 2 inputs
 A Y-shaped cable (stereo plug—mono jack x 2; refer to the illustration below) can be used to trigger inputs 9, 10, 11, and 12 (monaural pad). Also, if the KP125/65 kick pad is connected to this jack with a stereo cable, the external pad input jack on the KP125/65 can be used as the input for input jacks 9, 10, 11, or 12.

⑤ RIDE, ⑥ CRASH Compatible with three-zone pads.

⑦ HI HAT Compatible with stereo pads (with switches)

● **Y-shaped cable**

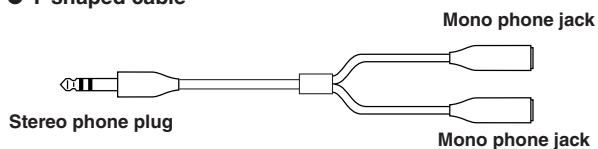

14 Hi-hat controller jack (HI HAT CONTROL)

For connecting a hi-hat controller. (p. 10, 11)

* Use a cable with a stereo plug (shown below) when connecting a hi-hat controller.

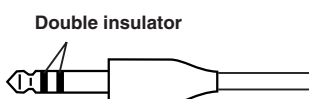

15 Output jacks (OUTPUT L/MONO, R)

For connecting the DTXPRESS IV to an external amplifier, mixer, etc.

For mono playback use the L/MONO jack. For stereo playback connect both L and R jacks. (p. 12)

16 Headphones jack (PHONES)

Connect a set of stereo headphones to this jack to monitor the DTXPRESS IV. (p. 12)

17 AUX IN jack

Connect the output of an external audio device, etc., to this jack (stereo mini jack). (p. 13)

This is convenient for playing along with music from a CD player, etc.

* Use the volume control on the external device to adjust the volume balance.

18 Master Volume (VOLUME)

Adjusts the DTXPRESS IV's overall volume (output level of the signal sent via the OUTPUT jacks and PHONES jack). Rotate the knob clockwise to increase the volume, or counter-clockwise to decrease it.

19 Power supply jack (DC IN 12V)

Connect the supplied AC power adaptor to this jack. To prevent the adaptor from becoming unplugged, secure the cable to the cable clip.

20 Cable clip

Prevents the power cord from accidentally becoming unplugged. (p. 12)

21 Standby/On switch (⏻)

The power is turned on when the button is set to this position: (⏻). The power is off when set this way: (■).

In this chapter, you'll learn how to set up the DTXPRESS IV. Read these instructions carefully and in the following order to ensure that the instrument sounds and operates properly:
1 Connecting the Pads → **2 Setting Up the Power Supply** (p. 12) → **3 Connecting to Speakers or Headphones** (p. 12) → **4 Turning the Power On** (p. 13) → **5 Selecting the Trigger Setup** (p. 14)

!! IMPORTANT !!

You'll need to change the Trigger Settings of the DTXPRESS IV according to the type of drum set you are using (Standard Set/Special Set/Acoustic Drums, etc.). If the setting is not appropriate, problems may occur—such as improper sound, or inappropriate volume balance among the pads.

Refer to the "Selecting the Trigger Setup" section on page 14 on how to select the appropriate setup.

1 Connecting the Pads

Referring to the illustration below, connect the output cable from each pad to each Trigger Input jack located on the rear panel of the DTXPRESS IV. All Trigger Input jacks are conveniently labeled (① SNARE, etc.), so make sure each pad is connected to its corresponding Trigger Input jack.

⚠ CAUTION

To prevent electric shock and damage to the devices, make sure the power is switched OFF on the DTXPRESS IV and all related devices before making any connections to the DTXPRESS IV's input and output jacks.

DTXPRESS IV Standard Set

Attaching the Module Stand

Attach the included module stand to the DTXPRESS IV using the module stand fastening screws.

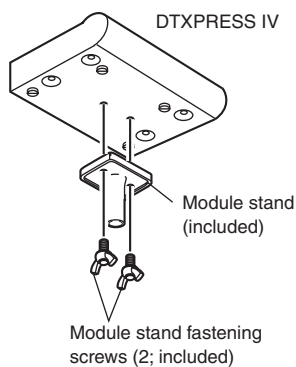

* Be sure to use the included screws.

NOTE

- The hi-hat pad can also be attached to the pipe to which the DTXPRESS IV is attached.

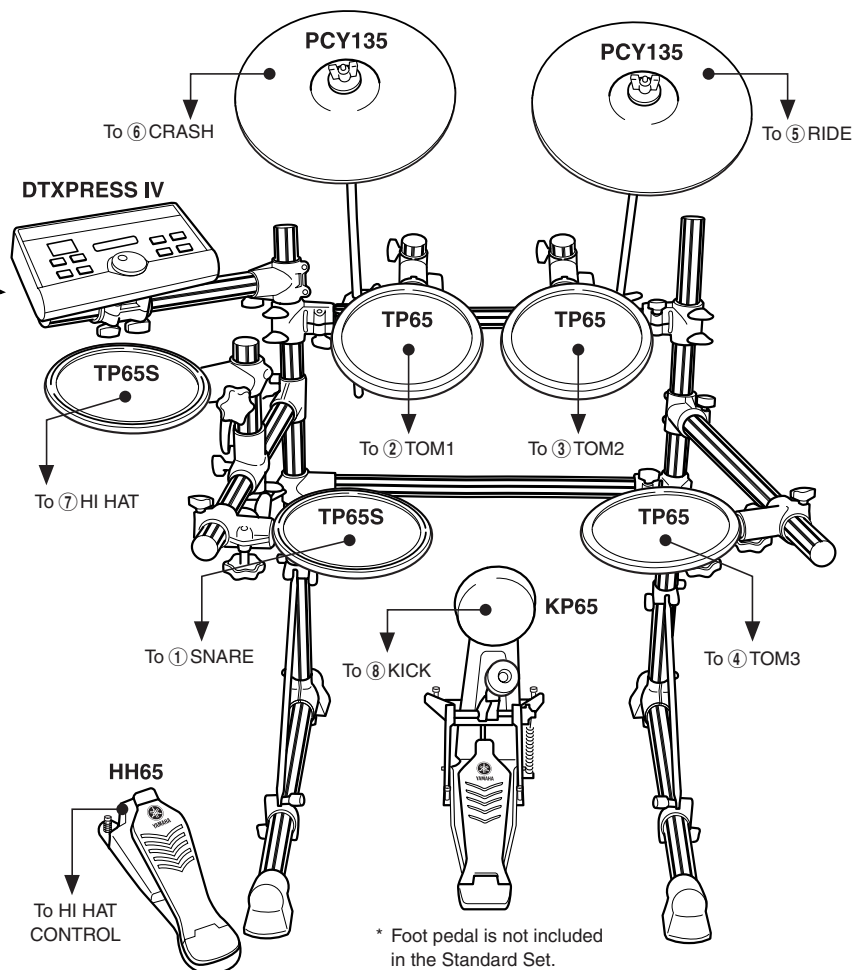

DTXPRESS IV Special Set

Attaching the Module Stand

Attach the included module stand to the DTXPRESS IV using the module stand fastening screws.

* Be sure to use the included screws.

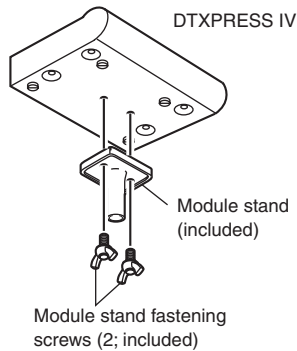

CAUTION

When assembling the Special Set, the legs of the rack must be slid backwards to maintain proper balance of the set. For details, refer to the assembly instructions of the rack system.

NOTE

The pad models described in the illustrations were included in the Standard Set/Special Set at the moment this Owner's Manual was produced. Keep in mind that the model names of your Standard Set or Special Set may be different from the ones illustrated here. For details about the latest information on Yamaha drum pads, refer to the following website.
<http://www.yamaha.co.jp/english/product/drums/ed/>

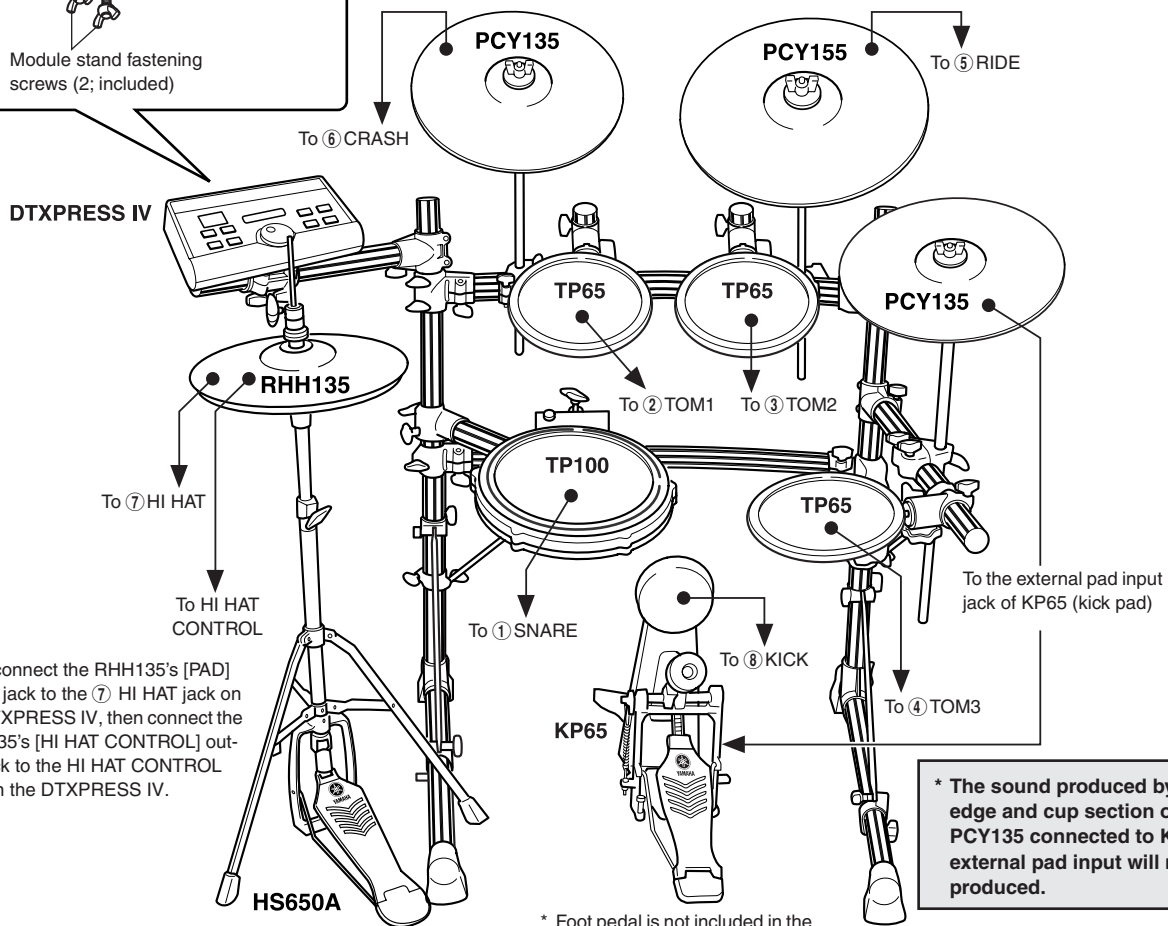

* First, connect the RHH135's [PAD] output jack to the ⑦ HI HAT jack on the DTXPRESS IV, then connect the RHH135's [HI HAT CONTROL] output jack to the HI HAT CONTROL jack on the DTXPRESS IV.

* The sound produced by the edge and cup section of PCY135 connected to KP65's external pad input will not be produced.

* Foot pedal is not included in the Special Set.

Setting up with Acoustic Drums

The DTXPRESS IV can be played from an acoustic drum kit if the kit is fitted with an optional set of drum triggers (such as Yamaha DT20 Drum Triggers) and the triggers are properly connected to the input jacks of the DTXPRESS IV.

2 Setting Up the Power Supply

A special power source adaptor supplies power to the DTXPRESS IV.

- 2-1. Make sure that the Standby/On switch (⏻) of the DTXPRESS IV is set to the standby (■) position.

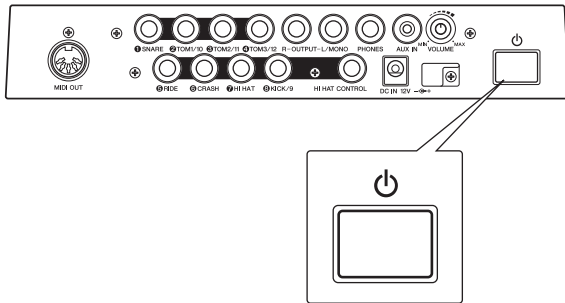

- 2-2. Connect the DC plug of the included AC power adaptor to the DC IN jack on the rear panel. To prevent the cord from being unplugged accidentally, wrap the cord around the cable clip and secure it.

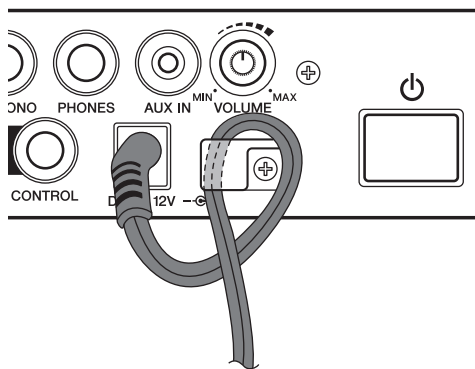

CAUTION

Make sure that the power adaptor's cord is not bent at an extreme angle when wrapping the cord around the clip. Doing this can damage or sever the cord and create a fire hazard.

- 2-3. Connect the other end of the power cord to an AC outlet.

WARNING

- Please use the included AC power adaptor. The use of any other adaptors may cause irregular operation or damage to the device.
- Only use the voltage specified as correct for the DTXPRESS IV. The required voltage is printed on the name plate of the DTXPRESS IV.

CAUTION

- Unplug the AC Power Adaptor when not using the DTXPRESS IV, or during electrical storms.

3 Connecting to Speakers or Headphones

Since the DTXPRESS IV has no built-in speakers, you'll need an external audio system or a set of stereo headphones to properly monitor it.

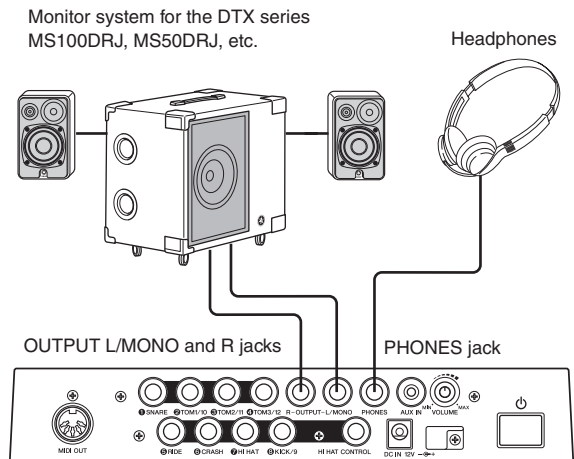

CAUTION

Whenever making connections, make sure that the plug on the cable being used corresponds to the type of jack on the device.

- **OUTPUT L/MONO, R jacks (standard mono phone)**

These jacks allow you to connect the DTXPRESS IV to an external amplifier + speakers and produce full, amplified sound, or connect the DTXPRESS IV to audio recording equipment for recording your own performance.

- * Use the DTXPRESS IV's OUTPUT L/MONO jack when connecting to a device with a mono input.

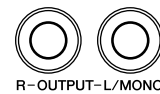

- **PHONES jack (standard stereo phone jack)**

Use the VOLUME knob on the rear panel to adjust the headphone volume.

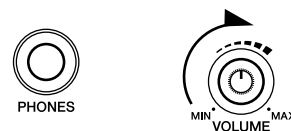

CAUTION

Do not use the DTXPRESS IV at a high volume level for a long period of time, or your hearing may be damaged.

● **AUX IN jack (stereo mini phone jack)**

The audio output from a MP3 player or CD player connected to the AUX IN jack can be mixed with the sound of the DTXPRESS IV and transmitted via the OUTPUT jacks or PHONES jack. This jack can be used when you want to play along with your favorite songs.

* Use the volume control on the external device (MP3 player, etc.) to adjust the volume balance.



● **MIDI OUT jack**

The MIDI functions on the DTXPRESS IV lets you play voices on an external tone generator with the pads of the DTXPRESS IV, or synchronize the DTXPRESS IV's song or click playback with the playback of an external sequencer.

About MIDI

MIDI (Musical Instrument Digital Interface) is a worldwide standard that enables you to connect instruments and computers—of different manufacturers and different types—and transmit performance and other data among them.



* Also, use a MIDI cable that is not more than 15 meters in length. Using a longer cable may result in irregular operation and other problems.

4 Turning the Power On

- 4-1. Make sure the volume settings of the DTXPRESS IV and external devices are turned down to the minimum.
- 4-2. Turn the power on (⏻) by pressing the Standby/On switch (⏻) on the rear panel of the DTXPRESS IV, then turn on the power of the amplifiers.

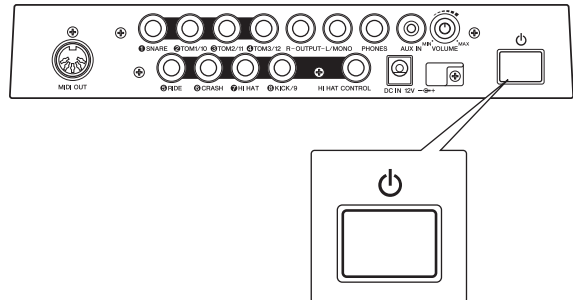

- 4-3. To turn off the power, press the Standby/On switch (⏻) again.

CAUTION

Even when the instrument is turned off, electricity is still flowing to the instrument at the minimum level. When you are not using the DTXPRESS IV for a long time, make sure to unplug the AC power adaptor from the wall AC outlet.

● **Connecting a Mixer or MIDI Devices**

Make sure that all volume settings are turned down all the way to the minimum. Then turn on the every device in your setup in the order of MIDI masters (controllers), MIDI slaves (receivers), then audio equipment (mixers, amplifiers, speakers, etc.). When powering down the setup, first turn down the volume for each audio devices, then switch off each device in the reverse order (first audio equipment, then MIDI).

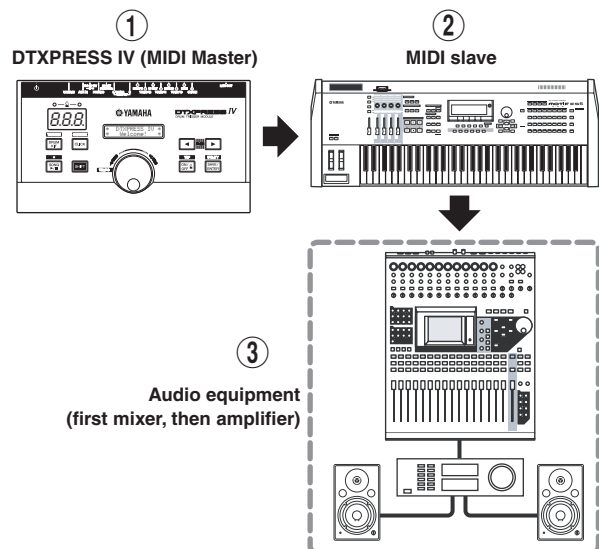

5 Selecting the Trigger Setup

This setting lets you select the Trigger Setup that most closely matches the trigger output levels and functions of your pads. Select an appropriate Trigger Setup for your drum kit from the pre-programmed Trigger Setups in the DTXPRESS IV. Use the operation described below to select the Trigger Setup you want to use.

● Procedure

5-1. Press the [SHIFT] + [DRUM KIT] buttons to view Page 1 in the Trigger Setup Select display (TRG1).

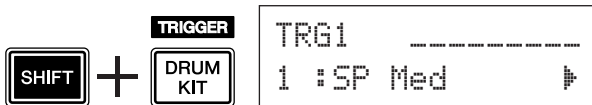

5-2. Rotate the jog dial to select the Trigger Setup that matches the drum kit you are using.

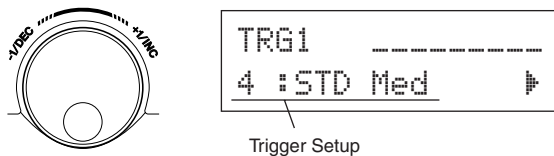

NOTE

- If you want to replace some of the pads from the DTXPRESS IV Standard Set / Special Set, refer to the operation on page 36 (Trigger Setup Edit) after the above setting is done, to make sure that the settings (such as sensitivity) are appropriate for each pad.

● About Connecting Pads

- The DTXPRESS IV's input jack parameters are preset with settings suitable for pads when an appropriate Trigger Setup is selected. If you intend to connect any other type of pad or a drum trigger (Yamaha DT20, etc.) to the input jack, that jack's parameters (sensitivity, etc.) should be changed to settings that suit the particular pad. Pad sensitivity is set in the Trigger Setup Select display's Page 3 [TRG3 Gain] setting (p. 38).
- Pad-controller-equipped pads like the TP120SD, TP100, etc., can be connected to Trigger Input jack ① SNARE.
- Three-zone pads like the TP65S, PCY155/150S, PCY135/130SC, etc., can be connected to Trigger Input jacks ⑤ RIDE and ⑥ CRASH.
- ⑦ HI HAT is a stereo input type jack. Pads equipped with trigger switches like the TP65S, PCY65S, PCY130S, etc. can be connected to this jack.
- The ② TOM1/10, ③ TOM2/11, ④ TOM3/12 jacks correspond to a two-trigger input that uses a stereo jack for L and R. A Y-shaped cable (stereo plug—mono jack x 2) can be used to input two trigger signals.
- The ⑧ KICK/9 jack accepts a two-trigger input using a stereo cable and jack for L and R signals. A Y-shaped cable (stereo plug—mono jack x 2) can be used to input two trigger signals.
Also, if the KP125/65 kick pad is connected to the DTXPRESS IV's input jack 9 with a stereo cable, the external pad input jack on the KP125/65 can be used as the input for Input jack 9.
- In addition to the ⑧ KICK/9 jack, the ② TOM1/10, ③ TOM2/11, and ④ TOM3/12 jacks can be used to connect a second bass drum pedal to create a double-bass drum set.

● Trigger Setup List

No.	Name		Features
1	SP Med	for Special Drum Set	Normal setting
2	SP Dyna		Wide dynamic range. This setting is designed for maximum expressive control, allowing performance subtleties over a wide dynamic range. Excessive vibration however, may result in crosstalk (sound being produced by other pads).
3	SP Easy		Controlled dynamic range delivers stable trigger detection. This setting is designed for producing a smoother, more uniform sound with reduced volume fluctuations.
4	STD Med	for Standard Drum Set	Normal setting
5	STD Dyna		Wide dynamic range. This setting is designed for maximum expressive control, allowing performance subtleties over a wide dynamic range. Excessive vibration however, may result in crosstalk (sound being produced by other pads).
6	STD Easy		Controlled dynamic range delivers stable trigger detection. This setting is designed for producing a smoother, more uniform sound with reduced volume fluctuations.
7	DT10/20	—	Use for DT10/20 drum trigger systems applied to acoustic drums.
8 11	UserTrig	—	Allows creation of custom trigger setups. (→Settings are made using Trigger Setup Edit on page 36.)

* In the default setting, "1. SP Med" for Special Drum Set is selected.

Now that your DTXPRESS IV is properly connected, it's time to make some music!

1 Play the DTXPRESS IV

While hitting the pads, turn the VOLUME knob on the rear panel to raise the overall volume to a comfortable level.

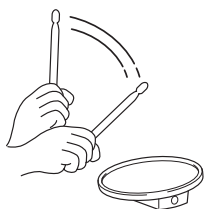

The trigger input level will be displayed in the bar graph in the upper right corner of the display. The bar graph indicates the input levels of the following input jacks.

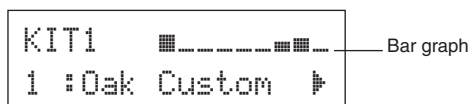

Bar graph (from left)	Corresponding input jacks
1	① SNARE
2	② TOM1/10
3	③ TOM2/11
4	④ TOM3/12
5	⑤ RIDE
6	⑥ CRASH
7	⑦ HI HAT
8	⑧ KICK
9	⑧ PAD9

2 Select a Drum Kit

A 'Drum Kit' is a collection of drum sounds (or voices) that play when you hit the pads. Try selecting some of the Drum Kits (1–50) and enjoy the variety of sounds and drum setups available.

* Preset Drum Kit List (p. 49)

Rotate the jog dial to select a Drum Kit.

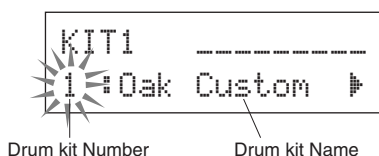
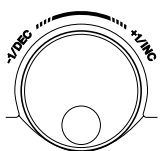

Try out the different drum kits and select one drum kit you like.

* Some Drum Kits have pad songs and drum loops that start playback when the corresponding pad is hit.

3 Change the Volume for Each Pad

Change the volume for each pad and adjust the overall balance of the Drum Kit.

Press the [▶] button once in the previous Drum Kit Select page.

The following display appears and the flashing cursor is at "S" in the LCD.

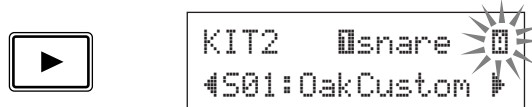

Press the [▶] button again to move the flashing cursor to the "S" position, the first character of "S01:OakCustom".

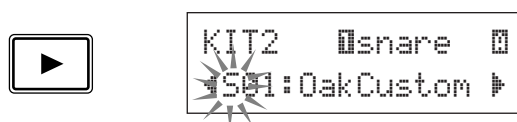

Press the [▶] button twice to view the KIT 3 page.



Use the [◀]/[▶] buttons in this manner to select the desired item (the cursor flashes). When the page only contains a single item, pressing the [◀]/[▶] buttons will select the next or previous page.

* The "▶" mark on the lower right side of the display indicates that a succeeding page is available. Likewise, the "◀" mark on the lower left side of the display indicates that a previous page is available.

In the KIT 3 page, hit the pad for which you want to change the volume. The selected pad (input jack) is shown in the upper half of the display.

Rotate the jog dial to adjust the volume (the value is flashing) of the pad.

* Some drum voices have two voices in a layer (in other words, two voices sound at the same time when a pad is hit). In case of two-layer voices, select the [◻] or [◻] mark in the upper right side of the display (press the [◀]/[▶] buttons so that the mark flashes, and use the jog dial to select) then adjust each volume.

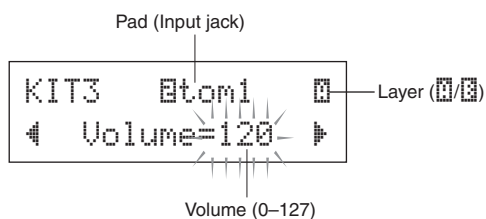

Volume (0–127)

CAUTION

An asterisk "*" will appear next to "KIT3" in the display once the volume is changed, indicating that the kit has been edited. This asterisk will disappear after the Store operation (p. 34) is carried out. If a different drum kit is selected, etc., before carrying out the Store operation, the current settings will return to their original condition. If you want to keep changes made to the data, make sure you carry out the Store operation.



4 Change the Output Sound Quality

Use the Master Equalizer found on Utility Page 5 to change the output sound quality. Overall settings for the DTXPRESS IV are set in the Utility pages.

First, press the [SHIFT] + [SAVE/ENTER] buttons to view the Utility pages.

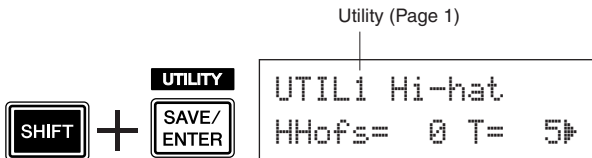

Press the [▶] button five times to view Utility Page 5.

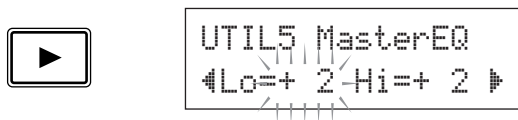

Now use the Master Equalizer (two-band shelving type) setting to change the sound quality.

"Lo=" is for the low-range gain setting (+0dB to +12dB) and "Hi=" for the high-range gain setting (+0dB to +12dB).

Press the [◀]/[▶] buttons to move the flashing cursor to the item you want to set, then rotate the jog dial to set its value.

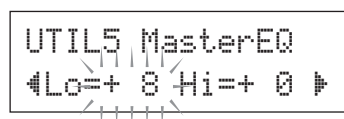
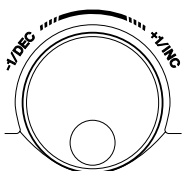

You can also adjust or set the individual pad voices, tuning, reverb type/level, and other settings that fine tune the DTXPRESS IV (p. 28).

Adjusting the Hi-hat

Hi-hat adjustment is used to determine the point at which the hi-hat closes when the hi-hat pedal (foot controller) is pressed. You can also set the threshold at which foot 'splashes' are produced.

* This setting is only valid when a foot controller is connected to the HI HAT CONTROL jack. The setting has no effect on a foot controller connected to any other jack.

Operation

1. Press the [SHIFT] + [SAVE/ENTER] buttons to view Utility Page 1.

Use this display to adjust the hi-hat.

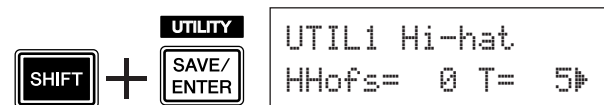

2. To set the point at which the hi-hat closes, move the flashing cursor to the "HHofs=" value then use the jog dial to adjust the value.

The range of adjustment is -32 to 0 to +32. Smaller values produce a shallower closing point.

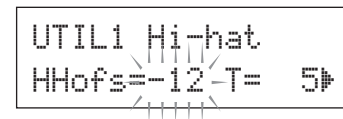

To set the ease at which foot splashes are produced, move the flashing cursor to the "T=" value then use the jog dial to adjust the value.

Settings include "off" and a range of 1 to 127. Larger values make foot splashes that are long and easier to produce. When this is set to "off," foot splashes are not produced.

* Too high a value will make foot splashes too easy to produce, resulting in the continuous production of foot splashes when the pedal is held down continuously.

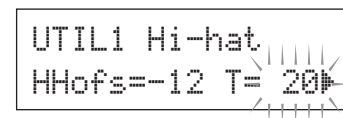

Pad Controller Settings

When a pad-controller-equipped pad (TP100, etc.) is connected, you can adjust the snares setting and tightness, tuning, or tempo by rotating the pad controller knob of the pad.

Operation (for Special Set users)

In the default setting, you can adjust the snares setting and tightness using the pad controller of the TP100 (the snare drum pad). To use functions other than the snares adjustment, change the setting as follows.

1. Press the [DRUM KIT] button to enter the Drum Kit Select display.

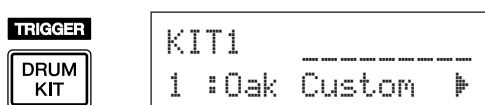

2. Next, continue pressing the [▶] button until Page 22 of the Drum Kit Select pages is called up.

3. Rotate the jog dial to change the value for "PadCtl="." You can select from the following functions.

off No function is assigned.
 snares Adjusting the snares setting and tightness (also affects the open rim sound)
 tuning.... Tuning adjustment (also affects the open rim sound)
 tempo Adjusting the tempo

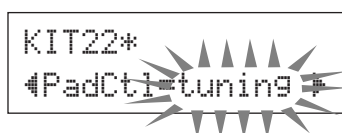

CAUTION

An asterisk "*" will appear next to "KIT22" in the display if the data has been changed. This asterisk will disappear after the Store operation (p. 34) is carried out. If a different drum kit is selected or the power is turned off before carrying out the Store operation, the current settings will return to their original condition. If you want to keep changes made to the data, make sure to carry out the Store operation.

Operation (Replacing the pad with one equipped with pad controller)

Here's how you can use the pad with pad controller (TP100) as a snare drum.

1. Use the TP100's supplied cable to connect the TP100 with trigger input ① SNARE on the DTXPRESS IV.

* Use ONLY the TP100's supplied cable. If another cable is used, the pad controller or the pad may not perform properly.

* The other trigger input jacks other than the ① SNARE are not compatible with pad-controller-equipped pads. The pad controller will not work if this type of pad is connected to a trigger input jack other than ① SNARE.

2. Press the [SHIFT] + [DRUM KIT] buttons to view the Trigger Setup display.

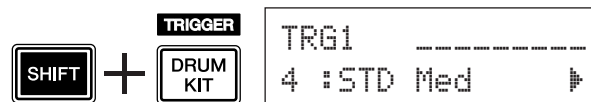

3. Next, press the [▶] button once to view the following display (pad type).

Hit the snare pad to view "snare" in the upper half of the display, then rotate the jog dial to set "Type= TP1/Snr."



CAUTION

An asterisk "*" will appear next to "TRG2" in the display if the data has been changed. This asterisk will disappear after the Store operation (p. 36) is carried out. If a different drum kit is selected or the power is turned off before carrying out the Store operation, the current settings will return to their original condition. If you want to use the selected pad again, make sure to carry out the Store operation.

4. Now you are ready to use the pad-controller-equipped pad.
 See the section "Operation (for Special Set users)" in the left column to change the function you want to use for the pad controller.

3 Playing Along With the Click

Play the DTXPRESS IV along with the click (metronome).

The DTXPRESS IV is equipped with a high-performance metronome that gives you a comprehensive variety of settings and allows you to create complex rhythms.

1 Start the Click (Metronome)

Press the [ON/OFF] button to start the click sound. The left lamp lights in red on the first beat of every measure when the click is playing. Other beats are indicated with the right lamp in green. The click tempo (♩=) is also indicated on the LED display. Press the [ON/OFF] button again to stop.

* If tempo is not shown, change the LED display setting (p. 21) to "Disp=tempo."

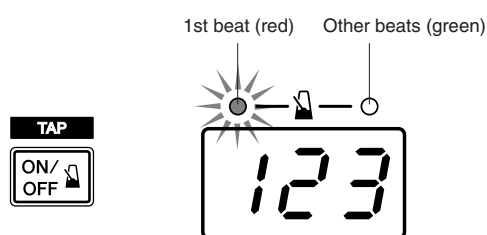

2 Set the settings for Click Set, Tempo, Beat, etc.

By fine tuning the different note value clicks that are shown in the illustration below, the DTXPRESS IV can be used to create a variety of click patterns. The patterns you set are called Click Sets, and you can save up to 30 original patterns in the DTXPRESS IV's memory.

Example: Beat timings used when Beat=4

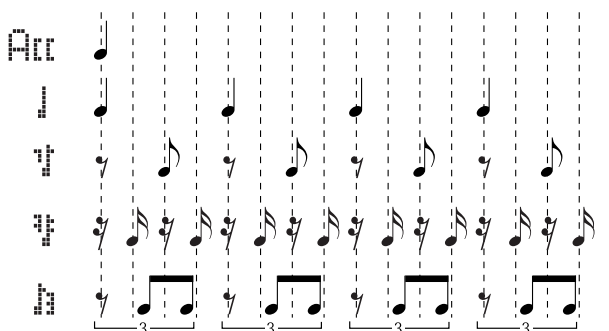

Press the [CLICK] button to view Click Setting Page 1.

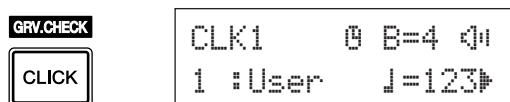

Use this display to select the desired Click Set, and then set the beat, tempo, timer, and the click sound's overall volume. Press the []/[] buttons to move the flashing cursor to the item you want to set, then rotate the jog dial to set its value.

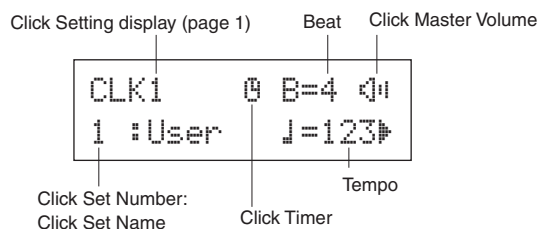

- **Click Set Number** [Range] 1 to 30
Selects the Click Set to be used.
- **Beat** [Range] 1 to 9
Determines the click's time signature.
- **Tempo** [Range] 30 to 300
Determines the click's tempo (♩=).
* The tempo can also be set using the Tap Tempo Function. This function lets you set the song or click's tempo by tapping in tempo on a pad. With this, you can set the tempo to one that feels best to you. Refer to page 21 for more information.
- **Click Timer** [Range] 0 to 600 seconds (in 30-second steps)
This function is used to automatically stop the click at the time set in this setting.
* The value (the remaining number of seconds) of the Click Timer can be shown in the LED display. Refer to page 21 for more information.
- **Click Master Volume** [Range] 0 to 16
Determines the click's overall volume.
* When the flashing cursor is not positioned here, the speaker icon will be displayed.

CAUTION

An asterisk "*" will appear next to "CLK1" in the display if settings for beat and tempo are changed. This asterisk will disappear after the Store operation (p. 20) is carried out. If a different Click Set is selected, etc., before carrying out the Store Operation, the current settings will return to their original condition. If you want to keep changes made to the data, make sure to carry out the Store Operation.

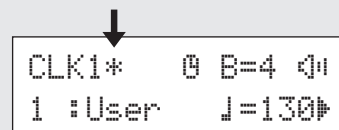

3 Create Your Own Original Click Set

Press the [▶] button to view Click Setting Page 2.

```
CLK2* Att=9 ↓=9
◀ ↑=6 ♯=4 h=2 ▶
```

Use this display to set the individual volume levels (0 to 9) for each of the five click beats. Set the volume level to “0” if you don’t want the beat to sound. Use this page to create your own original click set.

* For details about the five click beats, see the illustration example “Beat timings used when Beat=4” in step 2 on page 18.

4 Set the Click Measure Break

Press the [▶] button to view Click Setting Page 3.

```
CLK3*MeasBreak
◀ Meas=1 Brk=3 ▶
```

The Click Measure Break puts a muted “break” for the number of measures decided with the “Brk” setting (off, 1 to 9) after the click has played for the number of measures determined by the “Meas” setting (1 to 9). When values are set as above, the click is played for a measure then muted for 3 measures.

* Decide the number of measures to be muted at “Brk=” then the number of measures to be played at “Meas=”.
 * If the setting “Brk=off” is used, the click will not be muted.

5 Set the Click Sound Set

Press the [▶] button to view page 4 in the Click Setting display.

```
CLK4*Sound
◀ 1:Metronome ▶
```

The Click Sound Set is used to assign the five different click sounds that are produced by the metronome. The sounds are changed as a group.

[Range] Metronome, Wood Block, Percussion, A9090, Stick, Pulse, UserClick

With the “UserClick” setting you can use the CLK5 and CLK6 pages to fine-tune the click sound settings.

6 Set the User Click Sounds

Press the [▶] button to view Click Setting Page 5.

```
CLK5*Sound=1
◀ E20:Click1 ▶
```

Click Value Type

Voice Category/Voice Number: Voice Name

You can assign a different drum voice to each of the five click voices.

* This setting is only available if “UserClick” is selected in the CLK4 page.

First, select the click value type (Att, ↓, ↑, ♯, h) in the upper half of the display, then move the flashing cursor to the lower half of the display and select the voice you want to assign to the click.)

First, select the voice category.

● Voice Category

- K : Kick
- S : Snare
- T : Tom
- C : Cymbal
- H : Hi-hat
- P : Percussion
- E : Effect

Next, select the voice number and voice name. If the voice number is set to “00,” the indication “NoAssign” is shown for the voice name and no sound will be produced.

7 Tuning the User Click Sounds

Press the [▶] button to view Click Setting Page 6.

```
CLK6*Sound=1
◀ Tune=+ 0.0 ▶
```

Click Value Type

Tuning

You can individually tune each of the five click sounds.

* This setting is only available if “UserClick” is selected in the CLK4 page.

First, select the click value type in the upper half of the display, and then move the flashing cursor to the lower half of the display and set the tuning value in semitones (-24.0 to 0 to + 24.0).

8 Save an Original Click Set

After creating your own original Click Set, save it in the DTXPRESS IV's memory using the Store Operation described below.

CAUTION

Any changes made to the data will be lost if another Click Set is selected before carrying out the store operation. If you want to keep settings or changes, make sure to carry out the Store Operation.

- 8-1. Press the [SAVE/ENTER] button. The following display will appear.

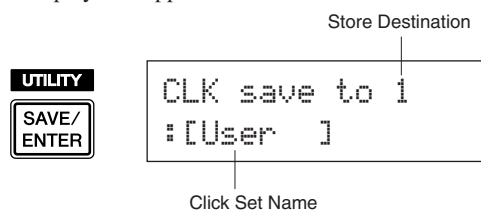

- 8-2. Rotate the jog dial to select the destination memory number (1 to 30) to which you want to store the Click Set.
- 8-3. If you want to change the Click Set name, press the [◀]/[▶] buttons to move the flashing cursor to the character you want to edit, then rotate the jog dial to select the desired character. A Click Set name can contain a maximum of six characters, and these can be selected from the following list.

space
!"#\$%&'()*+,-./0123456789:;<=>?@
ABCDEFGHIJKLMNPOQRSTUVWXYZ[^\`_~
abcdefghijklmnopqrstuvwxyz{|}~

- 8-4. Press the [SAVE/ENTER] button again. A prompt appears asking you to confirm the Store operation.

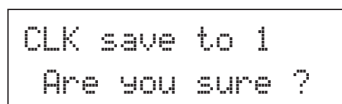

- 8-5. Press the [SAVE/ENTER] button to actually execute the Store operation.

* To cancel the Store operation, press any button except for the [SAVE/ENTER] and [SHIFT] buttons. (When "Are you sure?" appears in the display, the jog dial will also cancel the operation.)

The following display appears after the Store operation is complete.

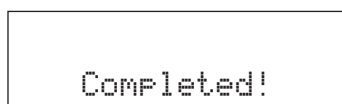

NOTE

- You can use the Factory Set operation to reset the click sets 1 through 30 to their original factory condition. However, please proceed with caution because carrying out this operation will rewrite the DTXPRESS IV's entire contents (all Click Sets, User Trigger Setups 8–11, User Drum Kits 51–70, User Songs 64–83, Utility settings) with the data that was set in the unit's memory when it was shipped from the factory (p. 35).

Click Out Select

The DTXPRESS IV lets you select from which output jack the signal of the click (metronome) is sent. Click output and performance output can be routed to separate outputs.

Operation

1. First, press the [SHIFT] + [SAVE/ENTER] buttons to call up the Utility display.

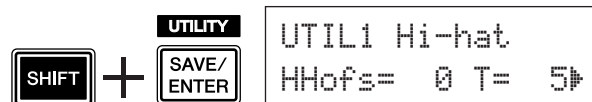

2. Next, press the [▶] button twice to call up the following display.

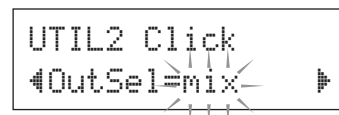

3. Rotate the jog dial to select the output from the outputs listed below.

- mix** This is the standard output setting. The click signal is output from both the OUTPUT L and R jacks.
- clickL** The click signal is output from the OUTPUT L jack only. All drum performance and song playback are output in mono via the OUTPUT R jack.
- clickR** The click signal is output from the OUTPUT R jack only. All drum performance and song playback are output in mono via the OUTPUT L jack.

* The PHONES jack outputs the same signal as the OUTPUT jacks. The settings in this section would then also be applied to the PHONES jack's stereo L and R.

Tap Tempo Function

With the Tap Tempo Function, you can set the song or click's tempo by manually tapping in the tempo on a pad. This lets you set the tempo to one that is most comfortable for you.

The [◀]/[▶] buttons can also be used to set the tempo instead of tapping on a pad.

Operation

1. Press the [SHIFT] + [ON/OFF] button. The Tap Tempo Setting display shown below will appear.

* The Tap Tempo function can even be used during song playback or while the click is sounding.



2. Tap on the pad at the tempo in which you want to play the song. (Or use the [◀]/[▶] buttons.) Tap on the pad steadily and repeatedly—as many times as there are circles (●●●●●) in the display. Every time you tap a circle disappears, and the resulting tempo value is set and shown in the LED display.

* Any pad will do.
* The jog dial can also be used to change the tempo value.



3. Press the [ON/OFF] button to hear your newly set tempo.
4. Press the [DRUM KIT], [CLICK], or [SONG ▶/■] button to exit from the Tap Tempo page. In the Click Setting page and Song Select page, the tempo is set to the newly selected tempo. If the song or click is playing, the tempo will immediately change to the new tempo.

LED Display Setting

Generally, the tempo is shown in the LED display. You can change the value to be displayed to one of the following three types.

- tempo Shows the current tempo.
- mode
 - When pressing the [DRUM KIT] button: Drum kit Number
 - When pressing the [SHIFT] + [DRUM KIT] buttons: Trigger Setup Number
 - When pressing the [SONG] button: Song Number
 - When pressing the [CLICK] button: Click Set Number
 - When pressing the [SHIFT] + [SAVE/ENTER] buttons: Shows nothing.
 - Others: Shows the current tempo.
- timer Shows the current click timer (p. 18).

Operation

1. First, press the [SHIFT] + [SAVE/ENTER] buttons to call up the Utility pages.

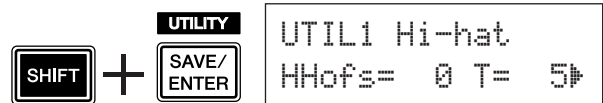

2. Next, press the [▶] button four times to call up the following page.

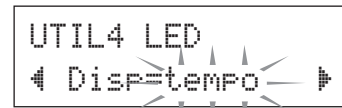

3. Rotate the jog dial to select the type you want to display.

Even though a parameter value other than “tempo” is shown in the LED display, when tempo is changed by one of the operations below, the new tempo briefly appears in the LED after the change is made.

- When the tempo is changed by holding the [SHIFT] button and rotating the jog dial.
- When operating a pad controller (p. 17) whose function is set to “tempo.”
- When hitting a specific pad whose pad function (p. 23) is set to “inc tempo” or “dec tempo.”

4 Playing Along With a Song

The DTXPRESS IV contains a wide variety of 63 preset songs. Try selecting among these and play along with them—they are effective tools that help you learn how to drum and master drumming techniques. The DTXPRESS IV conveniently lets you mute the drum part of a song and have only the bass part sound during playback, so you can play the drum part yourself.

1 Select a Song

Select one of the DTXPRESS IV's songs and listen. The DTXPRESS IV contains 63 preset songs that, in addition to drums, include accompaniment with keyboard, brass, and other voices.

* "Preset Song List" (p. 49)

Press the [SONG ▶/■] button to view the Song Select display.

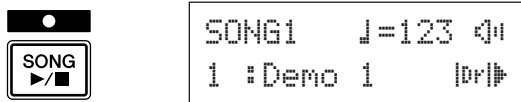

Make sure the song number is flashing, then use the jog dial to select a song number (1 to 63) you want to listen to.

* When a different song is selected, the drum kit changes to one that matches the song.

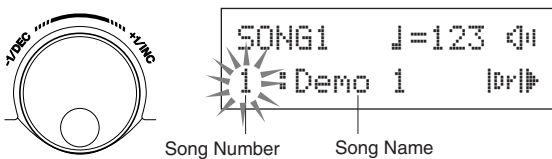

2 Listen to the Song

Press the [SONG ▶/■] button and after the count, the song will start playback from the beginning.

After the song has played to the end, it will automatically start playing from the beginning again.

Press the [SONG ▶/■] button to stop playback.



* If you've changed the song's tempo or its voices and want to return to the original, re-select the song.

* If a different song is selected during song playback, the new song will start playback from the beginning.

3 Adjust the Song's Volume and Tempo

Use the [◀]/[▶] buttons to select the tempo value (the value flashes), and then use the jog dial to set the song's playback tempo (♩ = 30–300).

Next, press the [▶] button to move the flashing cursor to the right. The speaker icon will change to a numeric value and flash. This determines the volume (range: 0–16) for parts other than the drum. Rotate the jog dial and adjust the balance between the song accompaniment and your performance.

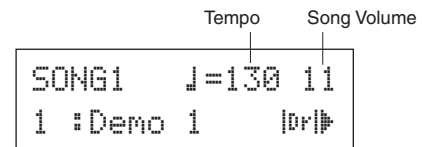

* The tempo can also be set using the Tap Tempo function. This lets you set the song or click's tempo by tapping in tempo on a pad. With this, you can conveniently set the tempo to one that feels best to you. Refer to page 21 for more information.

4 Mute the Drum Part

Try playing along with the song.

Press the [▶] button several times so that the "Dr" mark flashes in the lower right side of the display.

Next, rotate the jog dial clockwise to change the mark to "M" in the lower right side of the display, to mute the drum part of the song during playback.

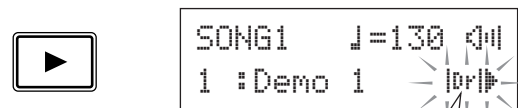

Rotate the jog dial counterclockwise.



Cancel the mute function.
(The drum part plays.)

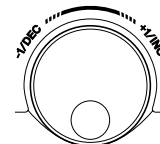

Rotate the jog dial clockwise.



Mute
(The drum part doesn't play.)

Now play the drum part yourself.

To cancel the Drum Mute function and hear the original drums, rotate the jog dial counterclockwise to change the "M" mark to "Dr" again.

* The Drum Mute setting can also be changed during song playback.

5 Adjust the Tuning

The song's tuning can be adjusted in increments of 10 cents.

The Tuning setting is found in the Utility pages.

First, press the [SHIFT] + [SAVE/ENTER] buttons to call up the Utility pages. Next, press the [▶] button 7 times to view the Master Tuning page shown below, then use the jog dial to adjust the tuning in semitones (-24.0 to 0 to +24.0).

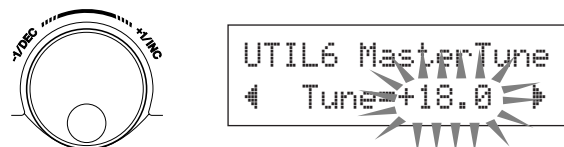

6 Play Along with Bass Solo

The useful Bass Solo function lets you isolate just the bass part during playback and play along with it. Since this function mutes the other accompaniment parts, it lets you concentrate on mastering the important technique of ‘locking in’ with the bass and forming a tight rhythm section.

First, press the [SHIFT] + [SAVE/ENTER] buttons to call up the Utility pages.

Next, press the [▶] button three times to call up the following page. Rotate the jog dial and select “BassSolo=on.”



With this set, press the [SONG ▶/■] button to start playback—only the bass part will be heard.

* You may find that with the drum part muted or the bass solo, it may be a little difficult to keep time. In this case, use the click along with the song. Using the click sound as a reference will make it easier to play along with the song. Press the [ON/OFF] button to have the click play in tempo along with song playback. Press the [ON/OFF] button again to stop.

* Changing the song will normally change the drum kit to the kit that is pre-assigned to the song. If you want to use a different drum kit when playing along with the song, press the [DRUM KIT] button to enter the Drum Kit Select display, and then select another drum kit number. If a different song is selected while Drum Mute is active, the drum kit will not change when a different song is selected.

Pad Function Settings

The DTXPRESS IV conveniently lets you execute important operations by hitting a specific pad—without having to press buttons on the panel. You can assign the following functions to the pads.

- off..... Normal operation.
- inc kitNo..... Increases the drum kit number by 1 (increment).
- dec kitNo..... Decreases the drum kit number by 1 (decrement).
- inc clkNo..... Increases the click set number by 1 (increment).
- dec clkNo..... Decreases the click set number by 1 (decrement).
- inc tempo..... Increases the value of the tempo by 1 (increment).
- dec tempo..... Decreases the value of the tempo by 1 (decrement).
- clkOn/Off..... Switches the click sound on/off.

Operation

1. First, press the [SHIFT] + [SAVE/ENTER] buttons to call up the Utility pages.

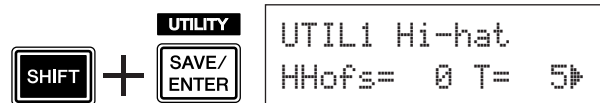

2. Press the [▶] button several times to call up the UTIL7 page.

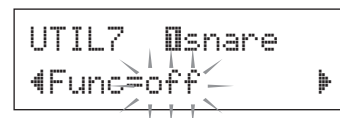

3. To select the pad (Trigger Input Source) to which you want to assign a function, simply hit the target pad, or press the [SHIFT] + [◀/▶] buttons.

4. Rotate the jog dial to select the desired function.

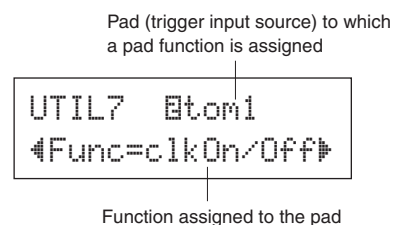

In the above setting, the click sound can be switched ON/OFF by hitting the tom1 pad which is connected to the ② TOM1/10 jack.

5 Using the Groove Check Function

Another highly useful feature of the DTXPRESS IV is the Groove Check function. As you play along with a song or the click, Groove Check compares your timing with the song or click playback and lets you know how accurate your playing is.

The related Rhythm Gate function—in which the sound is cancelled if your timing is off—also offers you a great way to improve your technique.

Groove Check Mode

The Groove Check function has the following two modes.

● Numeric Display Mode

In this mode, the accuracy of your drum hits is shown in numeric display.

The aspects shown in the numeric display are the average inaccuracy in the timing of each hit and the deviation in timing inaccuracy of all hits. To use this mode, select one of the modes other than “Challenge” from the Rhythm Gate settings in the GRV2 page.

* Hit timing display

If your timing is slow or you’re dragging the beat, the mark will move to the right side of the display. If your timing is fast or you’re pushing the beat, the mark will move to the left.

* Rhythm Gate range

With the Rhythm Gate function, sound is produced only if the hit is within the specified range, and sound is not produced if the hit is outside this range. The range of Rhythm Gate can be selected from three levels according to the degree of difficulty and if this is set to off, sound is always produced, no matter what your timing is. The selected range is shown in the lower side of the upper half of the display.

* Tempo

The jog dial can be used to adjust the tempo for the song or click from 30 to 300.

* Inaccurate timing display

The average inaccuracies in timing as compared to the note value set in page GRV4 are shown in numeric display. Range: 0 (perfectly accurate), 1–9 (in units of 1/24 of a 16th note)

The deviation in timing inaccuracy is 0.0 to 9.9. Of course, the smaller this value is, more “in the pocket” your playing is.

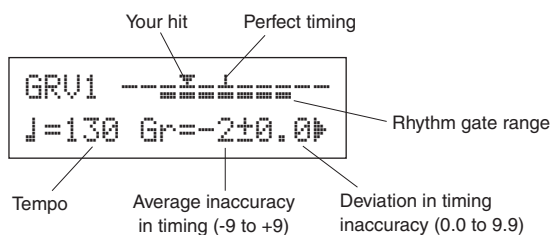

● Challenge Mode

The DTXPRESS IV automatically evaluates the accuracy of 100 times hits over six grade levels from A to F and sets the

range of Rhythm Gate according to the result. The tolerance automatically narrows if your hits are accurate and widens if your hits are inaccurate.

This mode can be used by selecting “Challenge” from the Rhythm Gate settings in the GRV2 page.

* Hit timing display

Just as with the Numeric Display mode, your timing is displayed with an icon.

* Rhythm gate range

The set range of the Rhythm Gate is shown in the lower side of the upper half of the display.

After a pad (pads) is hit a specific number of times, the DTXPRESS IV evaluates the accuracy of the hits and sets the range of Rhythm Gate automatically.

● Hit accuracy evaluation

In the lower half of the display, the number of remaining hits and the current evaluation result (%) are shown.

The current level (evaluation) and the status change during playback. If your playing accuracy result (%) was 90% or more, the level is raised one step, and if accuracy is 60% or less, the level is lowered one step.

- Current level (evaluation): A (best) to F (worst)

- The icon and the meaning of evaluation

- ⬆: Increases the strictness (as you continue playing in the same way)
- ⬆: Maintains the same strictness (as you continue playing in the same way)
- ⬆: Decreases the strictness (as you continue playing in the same way)

NOTE

- The level (evaluation) when the challenge mode begins is set to D.

* Tempo

Tempo is not shown in the Challenge mode display. To change the tempo, hold the [SHIFT] button and rotate the jog dial. You can adjust the tempo for the song or click from 30 to 300 (the tempo is shown in the LED display).

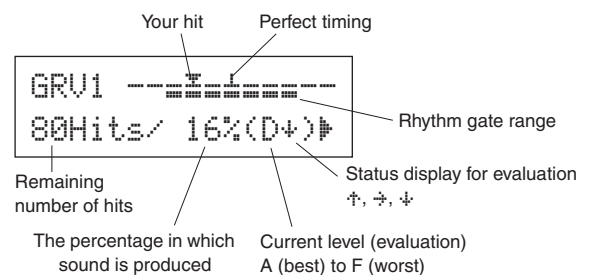

Now let's use the Groove Check function.

1 Select a Song or a Click Set

First, select the song or click set that you want to play along with.

2 Set the Rhythm Gate (select a mode)

Press the [SHIFT] + [CLICK] buttons to call up page 1 (GRV1) in the Groove Check Setting pages.



Next, press the [▶] button once to call up the GRV2 page, then rotate the jog dial to set the Rhythm Gate.



● Rhythm Gate settings

- offSound is always produced
- easyWide tolerance for sound production (easy)
- normalMid-level tolerance for sound production (average)
- PRONarrow tolerance for sound production (difficult)
- challenge...Tolerance changes by automatic evaluation (Challenge mode)

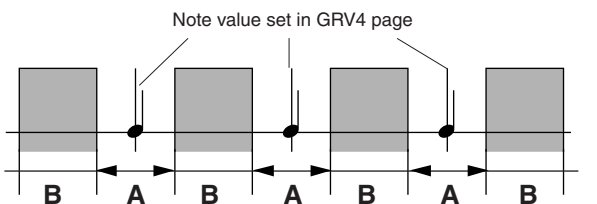

A: Range within which sound is produced. (The gate narrows as the setting changes from “easy” to “normal” to “pro.”)
 B: Range within which sound will not be produced even though the pad is struck.

3 Select the Pad

Press the [▶] button to call up the GRV3 page, then rotate the jog dial to select the pad (Trigger Input Source) that you want to check. The “ALL” setting selects all pads.

[Range] snare, tom1, ... pad12, all

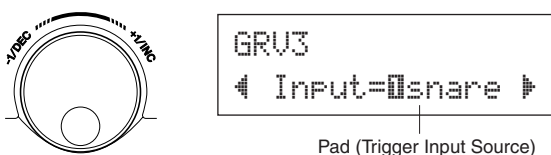

4 Set the Timing (note value)

Press the [▶] button to view page GRV4, then rotate the jog dial to select the note value of the timing you want to check.

[Range] Accent (4), eighth note (8), sixteenth note (16), eighth note triplet 3

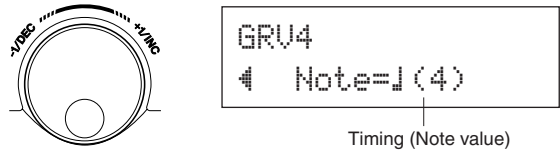

5 Start the Groove Check

After setup is complete, start playback of the song ([SONG ▶/■]) or the click sound ([ON/OFF]) and go back to the Groove Check’s main menu (the GRV1 page).

Groove Check begins as soon as you hit the pad specified in the GRV3 page.

6 Play as accurately as possible

Listen to the song or click and concentrate on playing the pads accurately. The jog dial can be used to adjust the tempo for the song or click.

If the Numeric Display mode is selected, stop the song or click and check the results. Change the Rhythm Gate setting, pad type, or note value as you like and enjoy practicing.

* The Groove Check’s results are reset the next time song or click starts playing.

If the Challenge mode is selected, when the remaining hits become zero, the final evaluation is displayed in six levels from A to F. With this evaluation, the range over which the sound is produced is set automatically. The higher the evaluation (A is the highest and F the lowest), the narrower the tolerance becomes.

* The Groove Check’s results are reset the next time song or click starts playing. The current level (evaluation) and the range over which sound is produced are also reset.

6 Record Your Performance

In this section, you'll learn how to record your performance to the DTXPRESS IV's built-in sequencer. In the song data you record, you can switch Drum Kits, change the tempo and playback in the same way as with Preset Songs.

Recording System

- Recording can be done with any of the User Songs (64–83). However, you cannot record to Preset Songs (1–63).
- A recorded song doesn't contain recordings of the audio 'sounds' of the drums, but rather the performance 'information' or data of precisely when and how each pad was hit. This information is called sequence data. Unlike audio data, sequence data can be freely used to change the tempo, select the voice or drum kit during playback.

Now, let's start recording...

1 Select the Song you want to record

Press the [SONG] button to display the Song Select display, select a User Song number (64–83).

If you want to play along with a Preset Song and record it, select the desired song (1–63). In this case, the lowest numbered empty User Song will automatically be selected for recording.

CAUTION

If a User Song containing data is selected, any recorded data previously existing is overwritten and lost.

2 Set the Recording Conditions

Simultaneously hold down the [SHIFT] button and press the [SONG] button to call up the following Recording Conditions setting page.

* If a Preset Song is selected for recording and all User Songs already contain data, the error message "Memory full" is shown. Use the Song Clear function (p. 27) to prepare an empty User Song, then set the recording conditions.

In this display set the click tempo, beat, and quantize.

Press the [◀]/[▶] buttons to move the flashing cursor to the item you want to set, then rotate the jog dial to set its value.

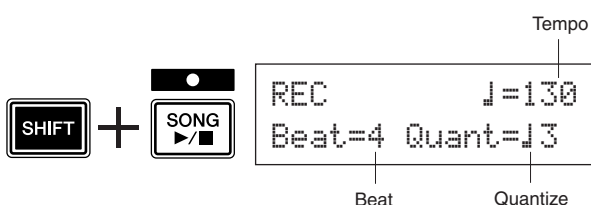

- **Tempo** [Range] 30 to 300
Sets the click's tempo (♩=) when recording.
- **Beat** [Range] 1 to 9
Sets the click's beat when recording.
- **Quantize** [Range] ♩, ♩♩, ♩♩♩ (eighth note), ♩♩♩ (eighth note triplet), ♩♩ (sixteenth note), ♩♩♩ (sixteenth note triplet), NO
The Quantize function can be applied during recording and is used to align the timing of your performance with that of the nearest specified beat. The accuracy of quantization is assigned with a note value.
* A setting of "no" results in no quantization.

● How Quantize Works (an example)

Recorded notes were not played in time.

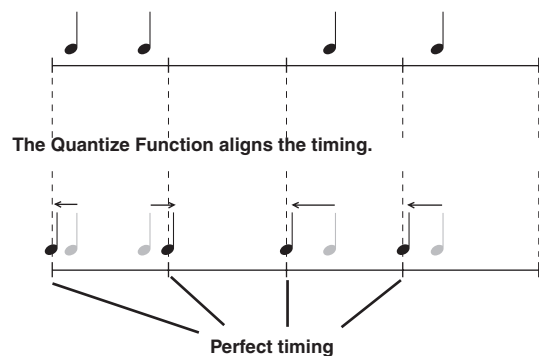

3 Start Recording

Press the [SONG] button and after the count, recording will start. Record while listening to the click sound.

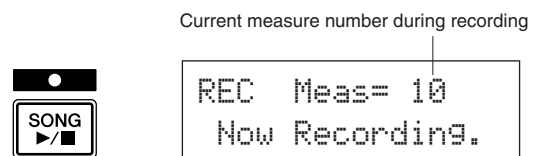

CAUTION

Never attempt to turn off the power during recording. All User Song data may be lost.

4 Finish recording

Press the [SONG ▶/■] button to finish recording. A “now storing ...” message is shown for a short time.



CAUTION

Never attempt to turn off the power while the “now storing ...” message is shown; all User Song data may be lost.

When saving is complete, a “completed!” message is shown and the Song Select page will reappear.

Even if the power is switched off, the completed song will be stored.

5 Listen to the Song

Following recording, the User Song number you recorded flashes in the Song Select page.

Press the [SONG ▶/■] button, and playback of the song you just recorded will start from its beginning.

* You can change the Drum Kit used for the recorded song. To change Drum Kits, press the [DRUM KIT] button to enter the Drum Kit Select display (KIT1 page) and rotate the jog dial to select a different kit.

6 Give the User Song a name

The song name of the recorded User Song is shown as the song name of the Preset Song or “Untitled.” Enter your own original name for the recorded User Song.

* The song names of the Preset Songs cannot be edited.

6-1. Press the [SAVE/ENTER] button in the Song Select page. The Song Name setting page is shown.

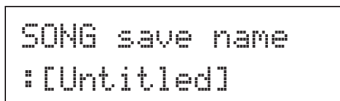

6-2. Press the [◀]/[▶] buttons to move the flashing cursor to the character you want to edit, then rotate the jog dial to select a character. A User Song name can contain a maximum of eight characters, and these can be selected from the following list.

- space
- !"#\$%&'()*+,-./0123456789:;<=>?@
- ABCDEFGHIJKLMNPOQRSTUVWXYZ[^_`
- abcdefghijklmnopqrstuvwxyz{|}~

6-3. Press the [SAVE/ENTER] button again. A prompt appears asking you to confirm the Store operation.

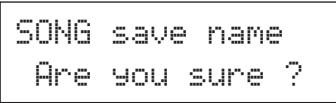

6-4. Press the [SAVE/ENTER] button once more to actually execute the Store operation.

* To cancel the Store operation, press any button except for the [SAVE/ENTER] and [SHIFT] buttons. (When “Are you sure?” appears in the display, the jog dial will also cancel the operation.)

When saving is complete, a “completed!” message appears and the Song Select page will reappear. The song name is confirmed.

7 Clearing a User Song

If you want to clear any unneeded User Songs, follow the operation below.

* Preset Songs cannot be deleted.

7-1. In the Song Select page, move the flashing cursor to the song number, and use the jog dial to select the User Song you want to delete.

7-2. Press the [▶] button twice to view the SONG2 page.

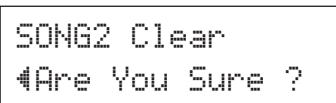

7-3. Press the [SAVE/ENTER] button. A “now clearing ...” message is shown for a short time.

CAUTION

Never attempt to turn off the power while the message “now clearing...” is shown; all User Song data may be lost.

7-4. When clearing data is complete, a “completed!” message is shown and the SONG1 page will reappear.

NOTE

- If the Factory Set operation is executed, all User Songs (64–83) will be lost. Please proceed with caution, since executing this operation will also rewrite the entire memory contents of the DTXPRESS IV (all Click Sets, User Trigger Setups 8–11, User Drum Kits 51–70, Utility data) with the data that was set in the unit’s memory when it was shipped from the factory (p. 35).

7 Create Your Own Original Drum Kit

The DTXPRESS IV lets you create your own original Drum Kit by assigning your favorite Drum Voice to each pad and setting its tuning, pan, decay, reverb, etc.

- * Drum Voice: Mainly individual percussion/drum sounds that are assigned to each of the pads.
- * Drum Kit: A collection of Drum Voices assigned to pads.

1 Select a Drum Kit

Press the [DRUM KIT] button to view the Drum Kit Select display (KIT1).



Rotate the jog dial to select the Drum Kit you want to use as a starting point for your original Drum Kit. A good idea is to select a Drum Kit that is close in sound to the type of kit you intend to create.

- * Preset Drum Kits (1–50) and user Drum Kits (51–70) can be used for editing as well.

2 Assign Drum Voices

In this example, we'll create a bass drum (kick) sound.

- 2-1. Press the [▶] button to view the Drum Voice Select page (KIT2).

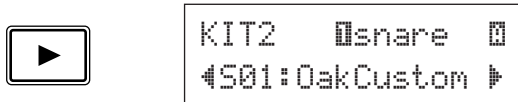

- 2-2. To select the pad (trigger input source) you want to edit, simply hit the pad you want to edit or use the [SHIFT] + [◀]/[▶] buttons.

Step on the kick pedal or press the [SHIFT] + [◀]/[▶] buttons and select "kick." Now the pad that is connected to the ⑧ KICK Trigger Input Jack is selected. In other words, the kick pedal's pad input is selected.

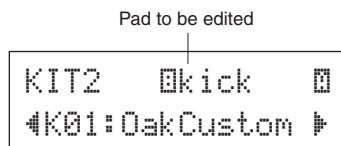
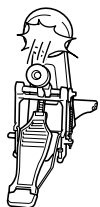

● About the Trigger Input Sources

The Input Source indicates the trigger data that is transmitted by the pads or drum triggers (Yamaha DT20, etc.) that are connected to trigger input jacks ① SNARE to ⑧ KICK/9 of the DTXPRESS IV.

When mono pads TP65, KP125/65, PCY65/130, DT10/20, etc. are used, one Input Source is assigned to one input jack. When stereo pads RHH135/130, PCY65S, etc. are used, two Input Sources (pad input and rim switch input or 2 kinds of pad inputs, etc.) are assigned to one input jack.

When three-zone pads TP65S, TP120SD/100, PCY155/150S/135/130SC, etc., are used, three Input Sources (pad input and two rim switch inputs, etc.) will be assigned to one input jack.

Each Input Source is defined as follows.

■snare	Pad input for ① SNARE jack.
■snrOf	Open rim switch input for ① SNARE jack.
■snrCl	Closed rim switch input for ① SNARE jack.
■snrOff	Pad input for ① SNARE jack with the snares off.
■snrOfOf	Open rim switch input for ① SNARE jack with the snares off.
■snrOfCl	Closed rim switch input for ① SNARE jack with the snares off.
■tom1	Pad input for ② TOM1 jack.
■tom2	Pad input for ③ TOM2 jack.
■tom3	Pad input for ④ TOM3 jack.
■ride	Pad input for ⑤ RIDE jack.
■rideE	Edge rim switch input for ⑤ RIDE jack.
■rideC	Cup switch input for ⑤ RIDE jack.
■crash	Pad input for ⑥ CRASH jack.
■crashE	Edge rim switch input for ⑥ CRASH jack.
■crashC	Cup switch input for ⑥ CRASH jack.
■hhOf	Pad input for ⑦ HI HAT jack when the hi-hat controller is open.
■hhOfE	Edge rim switch input for ⑦ HI HAT jack when the hi-hat controller is open.
■hhCl	Pad input for ⑦ HI HAT jack when the hi-hat controller is closed.
■hhClE	Edge rim switch input for ⑦ HI HAT jack when the hi-hat controller is closed.
■hhFtCl	Input when the hi-hat controller is pressed (foot close).
■hhSplsh	Foot splash input of the hi-hat controller.
■kick	Pad input for ⑧ KICK jack.
■pad9	Pad input for ⑨ PAD9 jack.
■pad10	Pad input for ⑩ PAD10 jack.
■pad11	Pad input for ⑪ PAD11 jack.
■pad12	Pad input for ⑫ PAD12 jack.

* Mono pads do not have a rim switch function.

- 2-3. The letter “1” displayed next to “kick” indicates layer number 1, and “2” indicates layer number 2. Two voices can be output (in a layer) through one input source. Select the voice to be edited here.

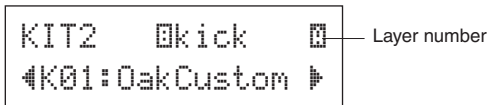

- 2-4. Next, decide the Drum Voice category. Drum Voice categories are the same as those used in the user click sound setting (p. 19).

● Voice Category

- K: Kick
- S: Snare
- T: Tom
- C: Cymbal
- H: Hi-hat
- P: Percussion
- E: Effect

Here, select “K: Kick”. Press the [◀]/[▶] buttons to move the flashing cursor to the Voice Category and rotate the jog dial to select “K”.

CAUTION

An asterisk “*” will appear next to “KIT” in the display if data is changed. This asterisk will disappear after the Store operation (p. 34) is carried out. If a different Drum Kit is selected, etc., before carrying out the Store operation, the current settings will return to their original condition. If you want to keep changes made to the data, make sure to carry out the Store operation.

- 2-5. Next, let’s select a Drum Voice. Press the [◀]/[▶] buttons so that the voice number flashes, then rotate the jog dial and assign a Drum Voice. The voice number and voice name will be displayed.

Here, select “K02:MapleCustm.”

* If the voice number is set to “00,” “NoAssign” is displayed as the voice name and no sound will be produced.

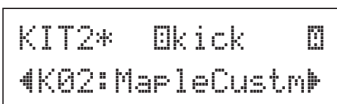

NOTE

- When Drum Voices are set for both layers 1 and 2, layer icon 1 or 2 is shown in the upper right hand corner of the KIT3 to KIT10 displays. Move the flashing cursor to this icon (if necessary) and rotate the jog dial to change the layer to be edited.
- When a Drum Voice is assigned to either of the layers 1 and 2 (the other is set to “NoAssign”), the layer icon is not shown in the KIT3 to KIT10 displays. The layer which has a Drum Voice is the target layer for editing.
- When Drum Voices are not assigned for either layer 1 or 2 (“NoAssign”), “---” will be shown in the KIT3 to KIT18 displays and the settings cannot be made.

Now you’ve selected the Drum Voice that will be used as the base for your original Drum Voice.

Next, let’s edit this Drum Voice and create your original bass Drum Voice.

Select and set the display that you want to be edited from page 3 to page 25 in the KIT screen.

Store the data when you change the settings!

Make sure to store the data after any settings have been changed.

For information about how to save, see steps 26. If a different drum kit is selected, etc., before carrying out the Store Operation, the current settings will return to their original condition. If you want to keep changes made to the data, make sure to carry out the Store Operation.

3 Change the Volume

This determines the volume of the Drum Voice that is output when the pad is hit. Use this to adjust the volume balance among the other pads.

Use the [▶] button to call up the KIT3 page, then rotate the jog dial to set the volume (0–127).

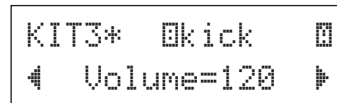

4 Change the Tuning (Pitch)

This determines the tuning (pitch) of the Drum Voice.

Use the [▶] button to call up the KIT4 page, then rotate the jog dial to set the tuning in semitones (-24.0 to 0 to +24.0).

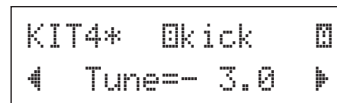

5 Change the Pan

This determines the Drum Voice’s pan setting (the voice’s position within the stereo field).

Use the [▶] button to call up the page KIT5, then rotate the jog dial to set the voice’s pan position.

The range is from “L64” (hard left) to “C” (center) to “R63” (hard right). As you rotate the dial, notice the voice change its position within the stereo field according to the setting.

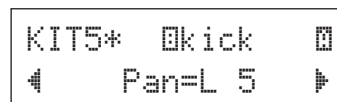

6 Change the Decay

This determines the Drum Voice's decay time (the time it takes the sound to fade out after being produced).

Use the [▶] button to call up the KIT6 page, then rotate the jog dial to set the decay (-64–0–+63). Positive values produce a crisper sound.

```
KIT6*  kick  [ ]
◀ Decay=+ 8 ▶
```

7 Change the Voice Character (Filter Setting)

This determines the filter's cutoff frequency to change the Drum Voice's character (brightness).

Use the [▶] button to call up the KIT7 page, then rotate the jog dial to set the cutoff frequency (-64–0–+63). Positive values produce a brighter sound.

```
KIT7*  kick  [ ]
◀ CutOffFreq=+ 4 ▶
```

8 Set the MIDI Note Number

This determines the MIDI Note Number that is transmitted when a signal is received from the input source. This affects which particular percussion or drum sound of a voice will play on a connected MIDI device.

Use the [▶] button to call up the KIT8 page, then rotate the jog dial to set the MIDI Note Number (0–127). Displays the note number and note name (C-2–G8).

```
KIT8*  kick  [ ]
◀ Note= 32/G#0 ▶
```

- * When the selected MIDI Note Number has already been assigned to another input source, an asterisk "*" will be displayed next to "Note=".
- * If the same MIDI Note Number is set to more than one pad within the same Drum Kit, the lowest numbered Input Source will take priority. In the case of the duplicate input sources, the same voice will be output.
If the setting is not available because of an already assigned MIDI note number, "(Note# in use)" or "(# in use)" is shown in the lower half of the display.

9 Set the MIDI Channel

This determines the MIDI Transmit Channel for the MIDI note on data that is transmitted when a signal is received from the input source. This affects which particular channel will be used when playing a voice on a connected MIDI device.

Use the [▶] button to call up the KIT9 page, then rotate the jog dial to set the MIDI Transmit Channel (1–16).

```
KIT9*  kick  [ ]
◀ MIDI Ch=10 ▶
```

10 Set the Gate Time of the MIDI Output

This determines the Gate Time (the length of time from Key On to Key Off) for the MIDI note on data.

Use the [▶] button to call up the KIT10 page, then rotate the jog dial to set the Gate Time (0.0s–9.9s).

```
KIT10*  kick  [ ]
◀ GateTime=0.3s ▶
```

11 Set the MIDI Key On/Off

This determines whether to recognize MIDI Key Off events or not.

* This setting affects both layers [] and []. The []/[] indication is not shown in the upper right corner of the display.

Use the [▶] button to call up the KIT11 page, then rotate the jog dial to set Key On/Key Off.

```
KIT11*  kick
◀ KeyOff=disable ▶
```

enableRecognizes Key Off events.
disableDoes not recognize Key Off events.

* When this is set to "disable," some voices may sound continuously. Press the [DRUM KIT] button to stop the sound.

12 Set the Hold Mode

Every time the pad is hit, Key On and Key Off messages are alternately sent. This means that one hit of the pad turns the sound on and the next turns it off.

* This setting affects both layers [] and []. The []/[] indication is not shown in the upper right corner of the display.

Use the [▶] button to call up the KIT12 page, then rotate the jog dial to set the Hold Mode.

```
KIT12*  kick
◀ HoldMode=off ▶
```

- on Each time the pad is hit, either a MIDI Key On or MIDI Key Off event will be transmitted alternately.
- off Normal operation. When a pad is hit, only a MIDI Key On event will be transmitted. After the decay time elapses, a Key Off event will be transmitted automatically.

* When this is set to "on," you should also set the Key Assign Mode to "hiHt" in the KIT15 page.

13 Set the Cross Fade

This determines the Velocity Cross Fade between the layer voices 1 and 2.

* This setting affects both layers 1 and 2. The 1/2 indication is not shown in the upper right corner of the display.

Use the [▶] button to call up the KIT13 page, then rotate the jog dial to set the Cross Fade type.

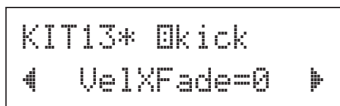

● Cross Fade Type

0 Cross Fade function is not in effect.

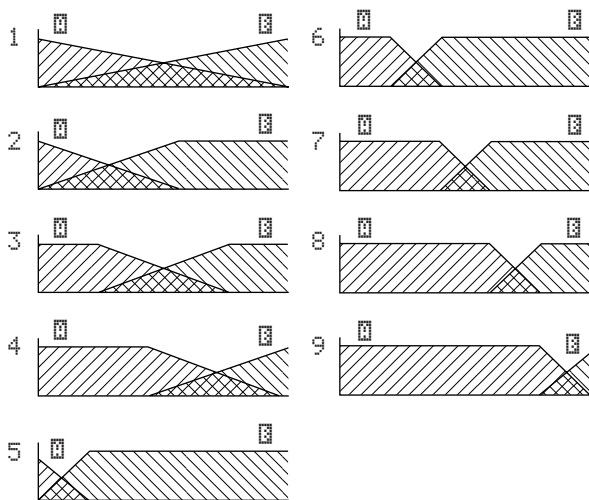

Vertical axis: Balance between layers 1 and 2
Horizontal axis: Velocity
 Layer 1
 Layer 2

14 Set the Alternate Group

This function allows you to assign different voices to the same alternate group, so that the playing of one sound in the group will automatically cancel others in the same group. A practical example of this is with the open and closed hi-hat voices. When you play an actual hi-hat—first open, then closed—the closed hi-hat naturally mutes the ringing open sound. Likewise, when the open and closed hi-hat voices are assigned to the same alternate group, the playing of one mutes the other.

* This setting has no effect on two-layer input sources. The 1/2 indication is not shown in the upper right corner of the display.

Use the [▶] button to call up the KIT14 page, then rotate the jog dial to set the Alternate Group.

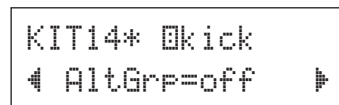

- off No cancellation
- HH Pad For the voice (hhOp, hhOpE, etc.) that is played when the hi-hat pad is hit.
- HH Ped For the voice (hhFtCl, hhSp1sh, hhCl, hhClE, etc.) that is played when the hi-hat pedal is pressed.
- 1-9 Alternate group number. Assigns the same group number for voices that you do not want to be output simultaneously.

15 Set the Key Assign Mode

This defines the sound output rules when multiple voices that are assigned to the same MIDI note number are simultaneously output.

* This setting affects both layers 1 and 2. The 1/2 indication is not shown in the upper right corner of the display.

Use the [▶] button to call up the KIT15 page, then rotate the jog dial to set the key assign mode.

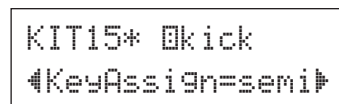

- poly Voices are output simultaneously.
- semi Up to three voices for this note number can be produced at one time. When a fourth voice is triggered, one of the first two voices will be muted (cancelled).
- mono One voice can be delivered at one time, and the previous voice will be muted (cancelled).
- high One voice can be delivered at one time, and the previous voice will be muted (cancelled). However, even if the maximum number of 32 notes is exceeded, the note number selected here will not be muted.

16 Set the Pad Song

When the pad is hit, the assigned pad song will start playback. In addition to one main song that is selected in the Song Select display, a maximum of three Pad Songs can be individually set for a Drum Kit.

* This setting affects both layers 1 and 2. The 1/2 indication is not shown in the upper right corner of the display.

Use the [▶] button to call up the KIT16 page, then rotate the jog dial to set the Song Number to be assigned, the Repeat function, and the Playback mode.

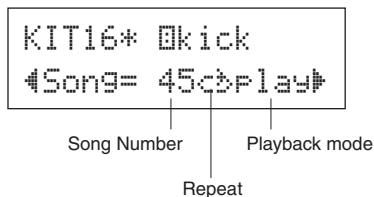

● Song Number

off, 45–63... Assigns the Song Number that is assigned to the pad

● Repeat Playback

c b Repeats playback of the song (when the song reaches the end it will start again from the beginning, continuously).

→ Normal playback.

● Playback Mode

Play When the pad is hit, playback of the assigned pad song will start/stop.

chse When the pad is hit, one measure of the assigned pad song will start playback then pause.

ctof When the pad is hit, playback of the assigned pad song will start/stop. However, if the pad song is set to “ctof,” the pad song will stop when another pad song with the “ctof” setting is started. This function allows only one “ctof” pad song to be played at a time.

* Up to three pad songs can be set for each Drum Kit. To assign a pad song for other pads, hit the target pad, or press the [SHIFT] + [◀]/[▶] buttons, so that the target pad name (trigger input source) is shown in the upper half of the display. However, when three pad songs are set, “Song=off” is shown and the settings cannot be made.

* The tempo of the pad song is the same as that of the main song that is found in the Song Select display or the Click Setting display.

* If a function is already assigned in the UTIL7 page to the input source that the pad song is assigned, “Song=(in use!)” is shown and the setting in the UTIL7 takes priority. (p. 23)

* When multiple pad songs are assigned and played back in combination, the voices within the songs may change unexpectedly or sound different than intended.

17 Set the Rim to Pad

This function is effective only when the input source is from a rim switch. When the rim is hit, pad events triggered from the same pad (trigger input jack) can be simultaneously transmitted with rim switch events. With this setting, a snare pad’s sound can be triggered at the same time as the snare’s rim shot.

* This setting affects both layers 1 and 2. The 1/2 indication is not shown in the upper right corner of the display.

* When an input other than the rim switch is selected for the input source, “RimToPad=---” will be displayed and the settings cannot be made. The following display appears when “1snr0f” is selected for the input source.

Use the [▶] button to call up the KIT17 page, then rotate the jog dial to set the Rim to Pad.

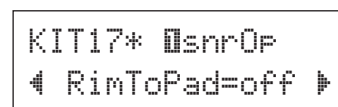

off Only transmits rim switch event.

on Transmits both rim switch event and pad event.

18 Change the Reverb Level (1)

This determines the Reverb Send Level for the voices (layers 1, 2) triggered by the input source. This effectively allows you to adjust the reverb depth.

* This setting affects both layers 1 and 2. The 1/2 indication is not shown in the upper right corner of the display.

* The actual Reverb Send Level is determined by adding the Send Level set here to the Drum Reverb Send Level set in the KIT19 page.

Use the [▶] button to call up the KIT18 page, then rotate the jog dial to set the Reverb Send Level (0–127).

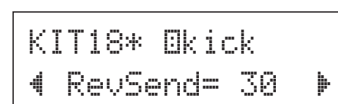

19 Change the Reverb Level (2)

This determines the Overall Reverb Send Level of the Drum Voice.

* This setting affects the entire Drum Voice. The 1/2 indication is not shown in the upper right corner of the display.

Use the [▶] button to call up the KIT19 page, then rotate the jog dial to set the Drum Reverb Send Level (0–127).

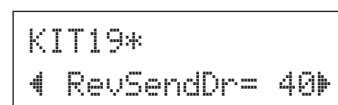

20 Change the Reverb Type

This determines the Type of Reverb effect for each Drum Kit. The same Reverb Type is applied to the entire Drum Kit.

* This setting affects the entire Drum Voice. The /🔓 indication is not shown in the upper right corner of the display.

Use the [▶] button to call up the KIT20 page, then rotate the jog dial to set the Reverb Type.

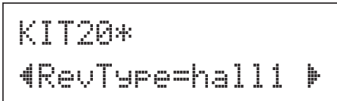

- none No reverb (same as thru).
- hall1-5 Simulates the reverb in a hall.
- room1-5 Simulates the reverb in a room.
- stage1-5..... Simulates the ambience of a stage.
- Plate..... Simulates a steel plate reverb.
- white..... A special short reverb effect.
- tunnel Simulates the reverb of a tunnel.
- bsemnt Simulates the reverb of a basement.

* The hall, room, or stage types with larger values produce a more pronounced reverb effect.

21 Change the Reverb Level (3)

This determines the Signal Return Level from the reverb effect for every Drum Kit. The same reverb type is applied to the entire Drum Kit.

By setting the level, you can adjust the reverb effect for the overall DTXPRESS IV system.

* This setting affects the entire Drum Voice. The /🔓 indication is not shown in the upper right corner of the display.

Use the [▶] button to call up the KIT21 page, then rotate the jog dial to set the Reverb Master Return level (0-127).

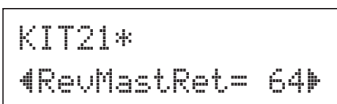

22 Set the Pad Controller

This is effective only when a pad equipped with pad controller is connected to the ① SNARE jack, and also when “Type=TP1/Snr” is assigned in the TRG2 page (pad type) of the Trigger Setup pages.

The following settings can be made by rotating the pad controller knob.

- offNo function is assigned.
- snareAdjusting the snares (also effective for the open rim sound)
- tuningAdjusting the tuning (also effective for the open rim sound)
- tempo.....Adjusting the tempo

For users of the DTXPRESS IV Special Set, set the Trigger Setup to “1 :SP Med” (p. 14) to enable this function. Depending on the Drum Kit you use, the default setting that can be adjusted by the pad controller varies.

* The /🔓 indication is not shown in the upper right corner of the display.

Use the [▶] button to call up the page KIT22, then rotate the jog dial to set the Pad Controller function.

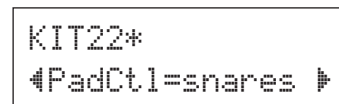

23 Set the Snares

This adjusts the snares effect (the characteristic sound of the coiled wires on the bottom of an actual snare drum) of the pad connected to the ① SNARE jack.

This also applies to pads not having a pad controller.

* The /🔓 indication is not shown in the upper right corner of the display.

Use the [▶] button to call up the KIT23 page, then rotate the jog dial to set the Snares adjustment level.

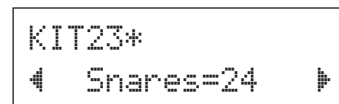

- offSnares off (reproduces the sound with the snares lifted off the drum)
- 1-24Snares are applied to the sound; the higher the value, the tighter the snares sound. (A value of “1” is the “loosest” snares setting.)

* When you change this setting, the decay setting (KIT6) for the input sources “ISnare” and “ISNR0F” also changes.

24 Set the Program Change and Bank Select

When a Drum Kit is selected, this function sets the MIDI Program Change Number and the Bank Select MSB and LSB that will be transmitted. This can be set for each MIDI channel.

By transmitting a program change message, you can have the voice of an external MIDI device automatically change when switching the Drum Kit on the DTXPRESS IV.

* The  indication is not shown in the upper right corner of the display.

Use the  button to call up the KIT24 page, then rotate the jog dial to make the following settings.

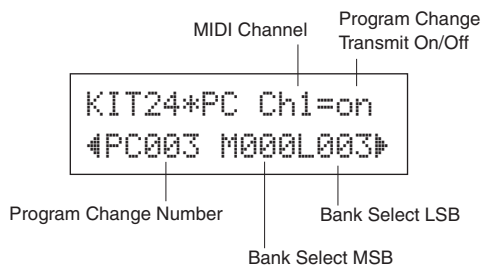

* When the Program Change Transmit On/Off is set to “off,” values for PC, M and L will be “----” and the settings cannot be made.

● MIDI Channel

1–16 Target MIDI channel for the Program Change

● Program Change Transmit On/Off

on Transmits.

off Does not transmit.

● Program Change Number

001–128 Transmitted program change number.

● Bank Select MSB, LSB

000–127 Bank select MSB number, LSB number

* For more information on Bank Select MSB and LSB, refer to the Voice List and MIDI Data Format documents, etc. of the particular external MIDI device you are using.

25 Set MIDI Volume and Pan—Control Change

This function sets the MIDI Control Change Volume and Pan values that will be transmitted when a Drum Kit is selected. This can be set independently for each MIDI channel.

This lets you automatically change the voice Volume and Pan on an external MIDI device when you switch the Drum Kit of the DTXPRESS IV.

* The  indication is not shown in the upper right corner of the display.

Use the  button to call up the KIT25 page, then rotate the jog dial to make the following settings.

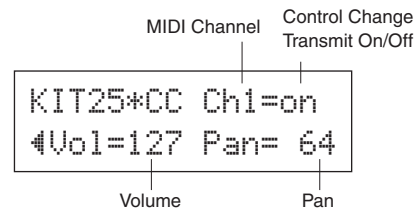

* When the Control Change Transmit On/Off is set to “off,” values for Vol and Pan will show “----” and the settings cannot be made.

● MIDI Channel

1–16 Target MIDI channel for Control Change messages

● Control Change Transmit On/Off

on Transmits.

off Does not transmit.

● Volume

0–127 Sets the Volume Control Change data value that will be transmitted.

● Pan

0–127 Sets the Pan Control Change data value that will be transmitted.

26 Save the Original Voice

To save the Drum Voice you created, use the Store operation described below and save it to the DTXPRESS IV’s memory. Original kits can be saved as a Drum Kit to the User Drum Kit (51–70) memory locations.

CAUTION

If you select a different Drum Kit before performing the Store operation, all changes you have made to the data will be lost. If you want to keep settings or changes, make sure to perform the Store operation.

26-1. Press the [SAVE/ENTER] button. The following display will appear.

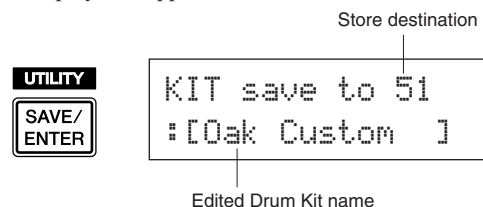

26-2. Rotate the jog dial to select the destination user Drum Kit number (51–70) that you want to store.

* Data cannot be stored to the Preset Drum Kits (1–50).

* You can save data to a User Drum Kit number that already contains data. However, be careful when doing this, since the previous data will be overwritten with the new data.

- 26-3. If you want to change the Drum Kit name, press the [◀]/[▶] buttons to move the flashing cursor to the character you want to edit, then rotate the jog dial to select a character. A Drum Kit name can contain a maximum of 12 characters, and these can be selected from the following list.

```
space
!"#$%&'()*+,-./0123456789:;<=>?@
ABCDEFGHIJKLMN O PQRSTU VWXYZ[^\_`
abcdefghijklmnopqrstuvwxyz{|}~
```

- 26-4. Press the [SAVE/ENTER] button again. A prompt appears asking you to confirm the Store operation.

```
KIT save to 51
Are you sure ?
```

- 26-5. Press the [SAVE/ENTER] button once more to actually execute the Store operation.
 *To cancel the Store operation, press any button except for the [SAVE/ENTER] and [SHIFT] buttons. (When "Are you sure?" appears in the display, the jog dial will also cancel the operation.)

When the Store operation is complete, the following display appears.

```
Completed!
```

With this operation, you have now created a Drum Kit that has an original bass Drum Voice.

Use the same procedure to create Drum Voices for the other pads (input sources) and create a complete custom Drum Kit of your own.

Factory Set

This operation returns all of the DTXPRESS IV's internal settings back to their original factory defaults.

Please proceed with caution, since executing this operation will also rewrite the entire memory contents of the DTXPRESS IV (all Click Sets, User Trigger Setups 8–11, User Drum Kits 51–70, User Songs 64–83, Utility data) with the data that was set in the unit's memory when it was shipped from the factory.

Operation

1. First, press the [SHIFT] + [SAVE/ENTER] buttons to call up the Utility pages.

```
UTILITY
SHIFT + SAVE/ENTER
UTIL1 Hi-hat
HHofs= 0 T= 5▶
```

2. Press the [▶] button several times to call up the UTIL8 page.

```
UTIL8
◀ Factory Set
```

3. From the page shown above, press the [SAVE/ENTER] button to call up the prompt shown below, asking for confirmation of the Factory Set operation.

* To cancel the Factory Set operation, press any button except for the [SAVE/ENTER] and [SHIFT] buttons (the jog dial can also be used to cancel the operation).

```
All data will be
lost.AreYouSure?
```

4. Once again, press the [SAVE/ENTER] button to proceed with the operation.

```
All Memory
Initializing...
```

8 Trigger Setup Edit

Trigger Setup Edit contains various settings related to trigger input signals received from pads or drum triggers (Yamaha DT20, etc.) that are connected to the trigger input jacks. These settings let you optimize the DTXPRESS IV for best operation and response to these signals. If you are using drum triggers attached to acoustic drums, or pads other than those that came with the DTXPRESS IV set, you'll need to adjust the sensitivity. This section also has settings that help prevent crosstalk* and double triggering*.

* Crosstalk: The interference between trigger signals of physically adjacent pads, producing unexpected notes.

* Double triggering: The condition where a single pad hit causes multiple (usually two) triggers.

Trigger Setup procedure

If you are using pads or drum triggers other than those that came with your DTXPRESS IV Set (Standard Set/Special Set), or if you need to solve problems with double triggering or crosstalk, the Trigger Setup provides more detailed settings—such as changing the preset's trigger setup—for individual pads.

If you've created a custom setup for these reasons or others, that setup can be saved to one of the Trigger Setup locations (8–11).

- 1 Press the [SHIFT] + [DRUM KIT] buttons to call up the Trigger Setup Select page (TRG1). The currently selected Trigger Setup is indicated in the display.

* If you want to edit a different trigger setup, use the jog dial and select the setup here.

Trigger Setup Select display (page 1)

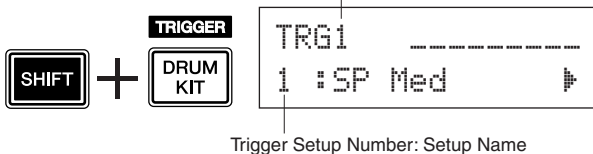

- 2 Use pages TRG2 through TRG8 to edit the Trigger Setup. Press the [◀]/[▶] buttons to change pages and move the flashing cursor to the parameter you want to set.

* Refer to pages 37 to 39 for more information on individual parameters.

To select the Trigger Input (input jack) you want to edit, simply hit the pad you want to edit or use the [SHIFT] + [◀]/[▶] buttons.

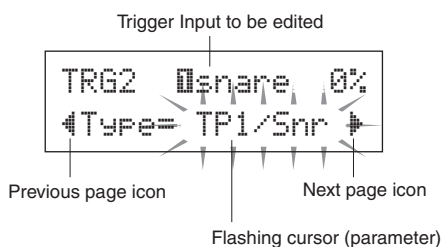

- 3 Rotate the jog dial to change the setting.

* An asterisk "*" will appear next to "TRG" in the display if data is changed. This asterisk will disappear after the Store operation is carried out.

* The Trigger Input Level produced when a pad is hit is shown on the upper right side of the display. When setting the gain, use this level as a guide to measure how hard a pad is being hit.

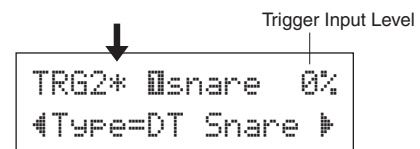

- 4 To save changes you've made to the data, use the procedure described below to store them to a User Trigger Setup (8–11).

CAUTION

If a different trigger setup is selected before executing the Store operation, all changes you have made to the data will be lost. If you want to keep settings or changes, make sure to carry out the Store operation.

- 4-1. Press the [SAVE/ENTER] button. The following display will appear.

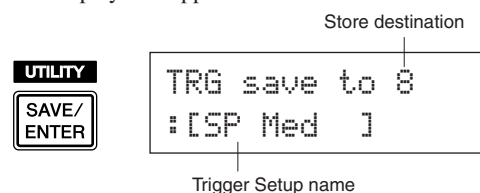

- 4-2. Rotate the jog dial to select the destination trigger setup number (8–11).
- 4-3. If you want to change the Trigger Setup name, press the [◀]/[▶] buttons to move the flashing cursor to the character you want to edit, then rotate the jog dial to select a character. A Trigger Setup name can contain a maximum of eight characters, and these can be selected from the following list.

space
!"#\$%&'()*+,-./0123456789:;<=>?@
ABCDEFGHIJKLMNPOQRSTUVWXYZ[^\`
abcdefghijklmnopqrstuvwxyz{|}~

- 4-4. Press the [SAVE/ENTER] button again. A prompt appears asking you to confirm the Store operation.

```
TRG save to 8
Are you sure ?
```

- 4-5. Press the [SAVE/ENTER] button once more to actually execute the Store operation.
- * To cancel the Store operation, press any button except for the [SAVE/ENTER] and [SHIFT] buttons. (When "Are you sure?" appears in the display, the jog dial will also cancel the operation.)

The following display appears after the Store operation is complete.

```
Completed!
```

CAUTION

Never attempt to turn off the power while the message "now storing..." is shown. All Trigger Setup data may be lost.

Explanations of Each Display Page

The following explanations cover the available parameters in the pages TRG1 through TRG8. To save the edited data, refer to step 4 on page 36.

TRG1 Trigger Setup Select

```
TRG1 -----
1 :SP Med ▶
```

[Range] 1-11

Selects the Trigger Setup Type (p. 14)

TRG2 Type (Pad Type)

```
TRG2 Snare 0%
Type=TP1/Snr ▶
```

Sets the type of pad that is connected to the input jack assigned in the upper half of the display ([①SNARE] in the example shown above).

* Values set in [TRG3 Gain, MVI (Minimum Velocity)] (p. 38) and [TRG5 RejTime (Self Rejection Time)] (p. 38) will automatically be changed to the proper values for the pad type you set here.

Pad types are defined as follows.

KP	KP125/80S/80/65/60
TP1/Snr	TP100/120SD
TP2/SnrA	TP65S/65 (mainly used as a snare pad) *1
TP2/SnrB	TP65S/65 (mainly used as a snare pad) *1, *2
TP2/Tom	TP65S/65 (mainly used as a tom pad) *1
TP3-A	TP80S/80/65/60 *3
TP3-B	TP80S/80/65/60 *3
PCY1	PCY155/150S
PCY2	PCY135/PCY130SC
PCY3	PCY130S/130
PCY4	PCY80S/80/65/60/10
RHH	RHH135/130
RHP Pad	RHP120SD/120/100/80 (pad side) *4
RHP Rim	RHP120SD/120/100/80 (rim side) *4
RHP Kick	KP120
BP	BP80 *5
DT Snare	DT series drum trigger (for a snare drum)
DT HiTom	DT series drum trigger (for small toms)
DT LoTom	DT series drum trigger (for large toms)
DT Kick	DT series drum trigger (for a bass drum)
misc 1-6	Other manufacturer's pads 1 to 6

8 Trigger Setup Edit

*1 Three-zone function (pad voice x 1, rim voice x 2) is available if a three-zone compatible pad such as the TP65S, etc. is connected to the ① SNARE, ⑤ RIDE, or ⑥ CRASH input.

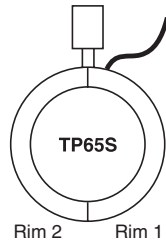

For producing closed rim shots, the "TP2/SnrA" has a high sensitivity setting on rim 1, while the "TP2/SnrB" has a high sensitivity setting on rim 2.

The same voice is assigned to "TP2/Tom" and "TP2/SnrA" and the left and right rim sensitivities are set to the same level.

*2 Rim1 and rim2 sounds on the "TP2/SnrB" are reversed from those on "TP2/SnrA". This provides left-handed drummers with a proper setting when using a left-handed setting.

*3 When a stereo pad such as the TP80S is connected to the ① SNARE, ⑤ RIDE, or ⑥ CRASH input, "TP3-A" will produce the sound that is assigned to rim 1, and "TP3-B" will produce the sound assigned to rim 2 (p. 28)

*4 When using an RHP series stereo pad, connect the pad to Input ② TOM1/10, ③ TOM2/11, ④ TOM3/12, or ⑧ KICK/9, and set the pad type in "Etom1", "Etom2", "Etom3", or "Ekick" input to "RHP Pad" and the pad type in "EPad10", "EPad11", "EPad12", or "EPad9" to "RHP rim."

*5 To use the BP80 as a stereo pad, connect the pad to Input ② TOM1/10, ③ TOM2/11, ④ TOM3/12, or ⑧ KICK/9.

TRG3 Gain, MVI (Minimum Velocity)

```
TRG3  Msnare  0%
←Gain=65MVI= 12▶
```

Gain [Range] 0-99

Adjusts the input gain (sensitivity) for the input jack assigned in the upper half of the page.

Setting a larger value lets a smaller input level from the pad create sound.

* This value will be automatically set after the appropriate pad type is set in [TRG2 Type (Pad Type)]. Some fine-tuning of the value will be necessary.

* Some pads are equipped with a sensitivity adjustment knob. For details, refer to the owner's manual that came with the particular pad.

MVI [Range] 1-127

Sets the MIDI Velocity (volume) that is transmitted when the pad is hit the softest. Large values will produce a high volume level even if the pad is hit softly. However, this will result in a narrow volume range making it difficult to adequately produce wider dynamic levels.

The Trigger Input Level will be displayed in percentage in the upper right hand corner of the display. The maximum velocity (input level 99 percent) will be 127. The lower the level is when the pad is hit the weakest, the wider the potential dynamic range will be.

* This value is automatically set after the appropriate pad type is set in [TRG2 Type (Pad Type)]. Some fine-tuning of the value will be necessary.

TRG4 VelCurve (Velocity Curve)

```
TRG4  Msnare  0%
←VelCurve=norm▶
```

Sets the Input Velocity Curve for the input jack assigned in the upper half of the page.



TRG5 RejTime (Self Rejection Time)

```
TRG5  Msnare  0%
← RejTime=1 ▶
```

[Range] 0-9

Prevents double triggering from occurring in the input jack assigned in the upper half of the page. After an event is detected, further events will be automatically muted for a certain length of time. The larger the value, the longer time events will be muted.

TRG6 RejLvlAll (Rejection Level)

```
TRG6  Msnare  0%
← RejLvlAll=2 ▶
```

[Range] 0-9

Prevents crosstalk from occurring in the input jack assigned in the upper half of the page. Events triggered by other pads (input jacks) that are of a lower input value than what is set here will not be triggered for a certain length of time. Larger values require a greater input level in order to produce a trigger event.

TRG7 RejLvl (Specified Rejection Level)

```
TRG7  Msnare  0%
←RejLvl1=3Frm=56▶
```

RejLvl [Range] 0-9

Frm [Range] 1-6, 56 (5 and 6), 7-12

This setting is used to prevent crosstalk between the input jack assigned in the upper half of the page and the input jack assigned in the "Frm=" setting.

After an triggering event occurs from the pad that is assigned in the “FRM=” setting, the pad assigned in the upper half of the display will not sound for a certain length of time unless the input level is greater than the value set here. Larger values will require a greater input level in order to produce a trigger event.

A “FRM=56” setting assigns both trigger input jacks 5 and 6.

TRG8 CopyToInput (Trigger Setup Copy)

```
TRG8 0snare
◀CopyToInput= 2▶
```

This function allows you to copy all data settings in pages [TRG2 Type (Pad Type)] through [TRG7 RejLvl (Specified Rejection Level)] to another input jack.

CAUTION

When the Trigger Setup Copy operation is carried out, the Trigger Setup data will be replaced with the settings of the copy source.

Operation

1. Hit a pad to select the copy source (input jack) from which the data will be copied.
Rotate the jog dial and assign the copy destination (input jack).

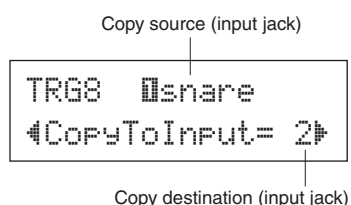

2. Press the [SAVE/ENTER] button. A prompt appears asking confirmation of the Copy operation.

```
Input Copy to 2
Are you sure ?
```

3. Press the [SAVE/ENTER] button to actually execute the Copy operation.

* To cancel the Copy operation, press any button except for the [SAVE/ENTER] and [SHIFT] buttons (the jog dial can also be used to cancel the operation).

The following display appears after the Copy operation is complete.

```
Completed!
```

Error Messages

The DTXPRESS IV displays error messages when incorrect settings have been made or invalid operations have been detected, or when any abnormal operation or malfunction occurs. If an error message appears, check the list below and make the appropriate corrections.

ERROR
Data Initialized

This message appears just after the power is switched on and the device cannot correctly read the data due to the Factory Reset operation being active.
The backup ROM data may have been damaged. Contact the nearest Yamaha Service Center or the dealer where you purchased the device.

ERROR
Memory full

You have exceeded the memory capacity of the user song.
Delete unused songs to make more memory available and try recording again.

ERROR
Can't Write Memory

Writing data to the backup ROM has failed.

Troubleshooting

The DTXPRESS IV does not produce sound, or does not recognize trigger inputs.

- Are the pads or drum triggers (Yamaha DT20, etc.) properly connected to the DTXPRESS IV's trigger input jacks? (p. 10, 11)
- Is the DTXPRESS IV properly connected to headphones or an external audio device such as an amplifier, speaker, etc.? (p. 12)
- Check the position of the Standby/On switches and volume levels of any connected external audio devices, such as an amplifier, speaker, etc.
- The volume knob on the rear panel may be turned down (p. 15).
- Is the gain set too low? (p. 38 [TRG3 Gain, MVI (Minimum Velocity)])
- The volume setting on the Drum Kit Select display's "KIT3 Volume" page (p. 29) may be set to "0."
- Is there a problem with the cable you are using?
- The drum voices for both layers \square and \square may be set to "00: NoAssign." (p. 29 Step2: [KIT2])

The external tone generator does not produce sound.

- Is the MIDI cable (connector) properly connected? (p. 13)
- Is the correct MIDI connector being used? (p. 13)
- Are the MIDI note number values appropriate? (p. 30 Steps 8 to 10: [KIT8], [KIT9], [KIT10])
- The drum voices for both layers \square and \square may be set to "00: NoAssign." (p. 29 Step2: [KIT2])

A voice other than the set voice is produced.

- Is the transmitting MIDI channel set to a channel that is not used for the drum voice (ch=10)? (p. 30, Step 9: [KIT9])
- Are two-layer voices set in the voice setting on the Drum Kit Select display? (p. 29 Step 2: [KIT2])

Produces sound but the sensitivity is too low (volume is low).

- Is the gain set too low? (p. 38: [TRG3 Gain, MVI (Minimum Velocity)])
- Pads with a level adjustment knob should be adjusted (increased).
- Is the minimum velocity set too low? (p. 38: [TRG3 Gain, MVI (Minimum Velocity)])
- Are you using a proper velocity curve? (p. 38: [TRG4 VelCurve (Velocity Curve)])
- Is the volume of the voice you want to use too low? (p. 29 Step 3: [KIT3])

The trigger sound is not stable. (For acoustic drums)

- Check the entry “Produces sound but the sensitivity is too low (volume is low)” above.
- Try selecting a larger pad type setting (DT snare → DT HiTom → DT LoTom → DT Kick). (p. 37: [TRG2 Type (Pad Type)])
- Is the Drum Trigger (Yamaha DT20, etc.) improperly attached with duct tape? (Is there any old adhesive remaining on the head?)
- Is the cable securely connected to the drum trigger (Yamaha DT20, etc.) jack?

Double triggering is produced.

- Pads with a level adjustment knob should be adjusted (lowered).
- Is the gain set too high? (p. 38: [TRG3 Gain, MVI (Minimum Velocity)])
- Use the self-rejection setting. (p. 38: [TRG5 RejTime (Self Rejection Time)])
- **(KP65)** Is the pad type for the input jack to which the KP65 is connected set to Kick Pad? (p. 37: [TRG2 Pad Type])
- Are you using drum triggers (trigger sensors) made by other manufacturers? Too large a signal can result in double triggering.
- Is the head causing irregular vibrations? It may be necessary to mute the head.
- When using acoustic drums, make sure the Drum Trigger is attached near the rim (above the bearing) and not near the center of the head.
- When using acoustic drums, make sure that nothing is touching the Drum Trigger.

Crosstalk (trigger interference from different inputs) is produced.

- Is the gain set too high? (p. 38: [TRG3 Gain, MVI (Minimum Velocity)])
- Try increasing the rejection parameter. However, avoid setting this value too high since that may cause the sound to not be produced when another pad (trigger input) is hit at the same time. (p. 38: [TRG6 RejLvlAll (Rejection Level)])
- If crosstalk is produced with a specific trigger input, try using specific rejection. (p. 38: [TRG7 RejLvl (Specified Rejection Level)])
- When using acoustic drums, place the Drum Trigger away from any nearby drum.

Sounds are cut when you play continuously.

- The maximum polyphony of 32 voices might be exceeded. In the Drum Kit Select display’s “KIT15 Key Assign Mode” page (p. 31), set the “KeyAssign” value to “semi” or “mono.”

When two pads (drums) are played only one sound is heard.

- Raise the gain setting of the pad (trigger input) that is not producing sound. (p. 38: [TRG3 Gain, MVI (Minimum Velocity)])
- Lower the rejection setting of the pad (trigger input) that is not producing sound. (p. 38: [TRG6 RejLvlAll (Rejection Level)])

- Lower the specified rejection setting of the pad (trigger input) that is not producing sound (p. 38: [TRG7 RejLvl (Specified Rejection Level)])
- Are both pads (trigger inputs) set to the same alternate group? (p. 31 Step 14: [KIT14])

The sound is always loud.

- Is the minimum velocities minimum value set too high? (p. 38: [TRG3 Gain, MVI (Minimum Velocity)])
- Are you using an appropriate velocity curve? (p. 38: [TRG4 VelCurve (Velocity Curve)])
- Are you using a pad made by another manufacturer? Depending upon the manufacturer, output levels might be too large.

The DTXPRESS IV does not receive any switch or trigger signals.

- If you can access the Utility display, perform the Factory Set operation. The DTXPRESS IV will reset to its factory settings. (p. 35: [UTIL8 Factory Set])
- Turn the power off then on while holding the [◀] and [▶] buttons together. The DTXPRESS IV will reset to its factory settings.

The sound does not stop.

- Some voices have very long release times when the “key off” parameter is set to “disable.” (p. 30 Step 11: [KIT11]) Press the [DRUM KIT] button to temporarily stop the sound.

The pad controller function does not work

- Have you connected a pad equipped with a pad controller, such as the TP100 or TP120SD?
- Are the pad controller settings properly set? (p. 17)

The Closed Hi-Hat voice is not produced.

- Is the proper pad type selected? If the RHH135/130 is used as a hi-hat controller, the pad type must be set to “RHH.” (p. 37: [TRG2 Pad Type])

The edge or cup sections of the cymbal pad do not produce sound when struck. The choke functions do not work.

- Is the proper pad type selected? Select the appropriate pad type for the kind of cymbal pad you are using. (p. 37: [TRG2 Pad Type])
- The sound produced by the edge and cup section will not be produced when a pad equipped with a rim switch (PCY135/155 etc.) is connected to the Input jack ⑨–⑫.

Foot Splashes are not produced.

- Is the foot controller connected to the HI HAT CONTROL jack?
- Adjust the detection time of foot splashes. (p. 16: Adjusting the Hi-hat)

I need to restore the original factory settings of the instrument.

- Use the Factory Set function (p. 35) to reset the DTXPRESS IV internal settings to the initial factory settings.

Index

Symbols

- ⏪ 15
- ⏩ 15
- [◀], [▶] 8
- [⏻ ON/OFF] 8, 18
- * 16, 17, 18, 29
- ⏸, ⏹ 15
- ⏺, [Dr] 22

A

- Accessories 3
- Acoustic drums 11, 41
- Alternate group 31
- AUX IN 9, 13

B

- Bank select 34
- Bass solo 23
- Beat 18

C

- Cable clip 9, 12
- Challenge mode 24
- Clear 27
- [CLICK] 8
- Click 18
- Click lamp 8
- Click master volume 18
- Click measure break 19
- Click out select 20
- Click set 18, 19
- Click set name 20
- Click sound set 19
- Click timer 18, 21
- Closed rim shot 38
- Closing point 16
- Connections 10
- Control change 34
- Copy 39
- CopyToInput 39
- Cross fade 31
- Crosstalk 36, 38, 41

D

- DC IN 12V 9, 12
- Decay 30
- Double triggering 36, 38, 41
- Double-bass drum set ... 14
- [DRUM KIT] 8
- Drum kit 15, 28
- Drum kit list 49
- Drum kit name 35
- Drum voice 28

- Drum voice list 48
- DT20 14, 36, 41

E

- Error messages 40

F

- Factory set 35
- Filter 30
- Foot controller 16
- Foot splashes 16, 41

G

- Gain 38
- Gate time 30
- Groove check 24

H

- Headphones 9, 12
- HI HAT CONTROL 9
- Hi-hat controller 9
- Hi-hat pedal 16
- Hold mode 30

I

- Input level 15

J

- Jog dial 8

K

- Key assign mode 31
- Kick pad 14

L

- Layer 15, 29, 31
- LCD display 8, 44
- LED display 8, 21

M

- Master equalizer 16
- Metronome 18
- MIDI 13
- MIDI channel 30
- MIDI data format 43
- MIDI implementation chart 47
- MIDI key on/off 30
- MIDI note number 30
- MIDI OUT 9, 13
- Minimum velocity 38
- Module stand 10, 11
- Mute 19, 22
- MVI 38

N

- Numeric display mode .. 24

O

- OUTPUT 9, 12

P

- Pad 28
- Pad controller 9, 14, 17, 33
- Pad function 23
- Pad song 15, 32
- Pad type 37
- Pad with switch 9, 14
- Pan 29, 34
- PHONES 9, 12
- Playback mode 32
- Power supply 9, 12, 13
- Program change 34

Q

- Quantize 26

R

- Rear panel 9
- Record 26
- Rejection level 38
- RejLvl 38
- RejLvlAll 38
- RejTime 38
- Repeat playback 32
- Reverb 32, 33
- Reverb type 33
- Rhythm gate 24, 25
- Rim shot 32
- Rim to pad 32

S

- Save 20, 34, 36
- [SAVE/ENTER] 8
- Self rejection time 38
- Sensitivity 14, 38, 40
- [SHIFT] 8
- Snares 17, 33
- [SONG ▶/■] 8, 22
- Song 22
- Song list 49
- Song name 27
- Sound quality 16
- Speaker 12
- Special set 11, 14
- Specifications 50
- Specified rejection level 38

- Standard set 10, 14
- Standby/On switch 9
- Stereo pad 9, 38
- Stereo plug 9
- Store operation 20, 34, 36

T

- Tap tempo 21
- Tempo 17, 18, 21, 22
- Three-zone pad .. 9, 14, 38
- Top panel 8
- Trigger input jacks 9
- Trigger input source 28
- Trigger setup ... 14, 36, 37
- Trigger setup copy 39
- Trigger setup name 36
- Tuning
 - Click 19
 - Drum voice 29
 - Pad controller 17
 - Song 22
- Type 37

U

- User click sound 19
- User drum kit 34
- User song 27
- User trigger setup 36
- Utility 16

V

- VelCurve 38
- Velocity curve 38
- Voice category 19, 29, 48
- Voice character 30
- VOLUME 9, 15
- Volume
 - Click 18
 - Control change 34
 - Drum voice 29
 - Headphone 12
 - Overall 9, 15
 - Pad 15
 - Song 22

Y

- Y-shaped cable 9, 14

MIDI Data Format

1. Channel Messages

The channel messages described below are sent from the drum triggers only. Other messages are sent from both the drum triggers and the sequencer.

1.1 Key On, Key Off

Note range: 0 (C-2)–127 (G8)

Velocity range: 0–127

1.2 Control Change

1.2.1 Bank select MSB, LSB–0, 32

data = 0–127

1.2.2 Foot controller–4 (Ch. 10 only)

1.2.3 Main volume–7

1.2.4 Pan–10 (left 0, right 127)

1.3 Program Change

2. System Exclusive Messages

2.1 Parameter Change

2.1.1 GM system ON

\$F0 \$7E \$7F \$09 \$01 \$F7 (hexadecimal)

Sets all messages (except MIDI master tuning) to their initial values.

3. System Realtime Message

3.1 Timing clock

Sends data.

3.2 Start, Stop

Sends data.

3.3 Active sensing

Sends the messages within an interval of approximately 300 msec.

LCD Displays

* The above "LCD Displays" charts show you the pages available in each display.
 Keep in mind that the actual displays on the instrument may be different from those shown here.

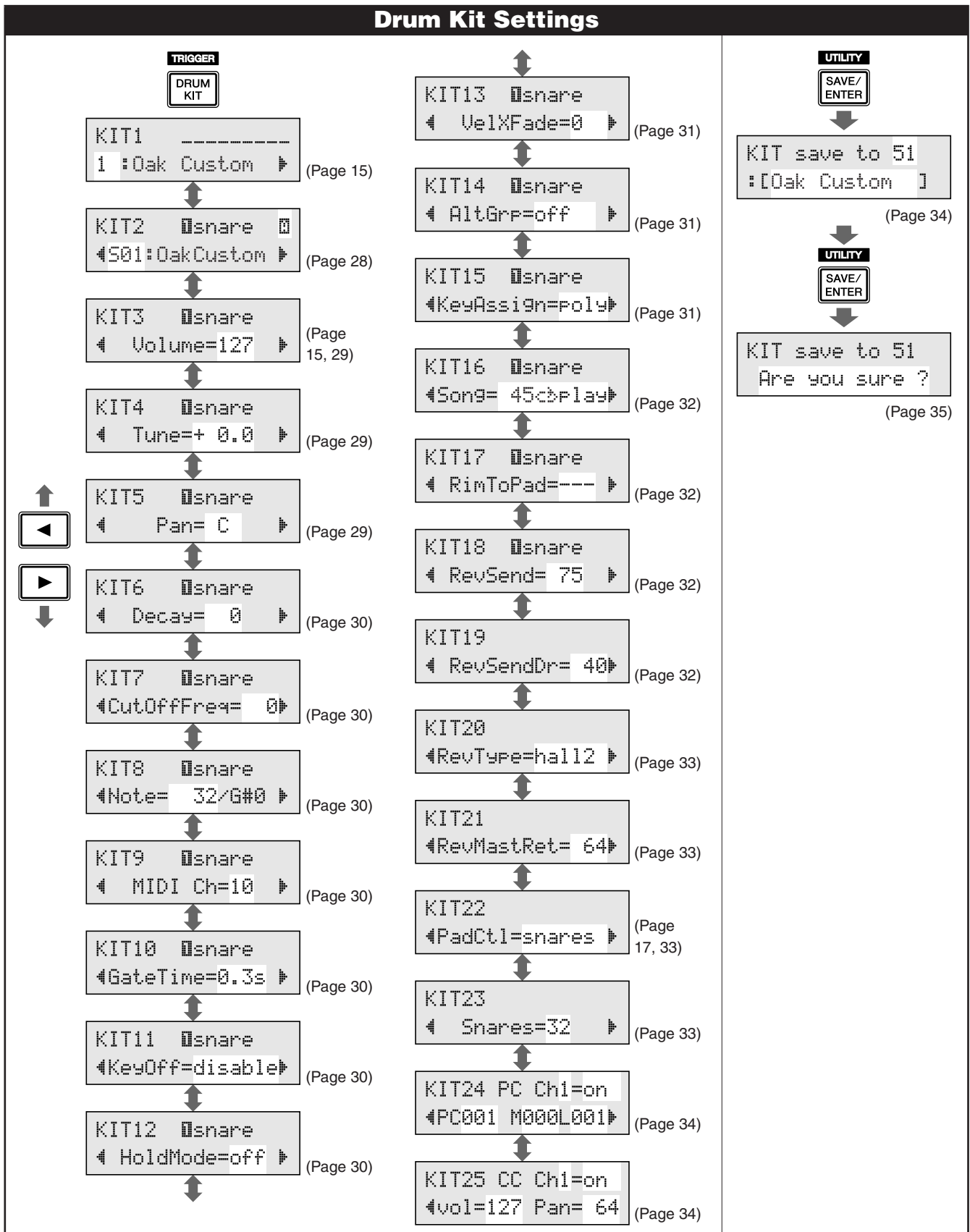

Song Selection

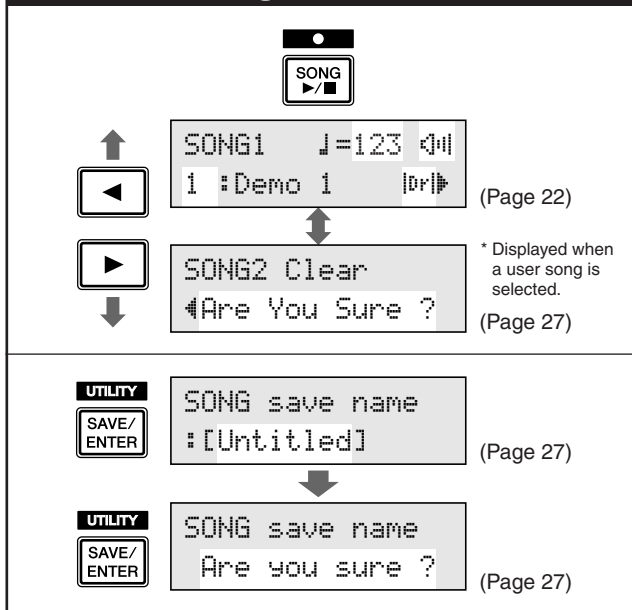

Song Recording



Groove Check Function

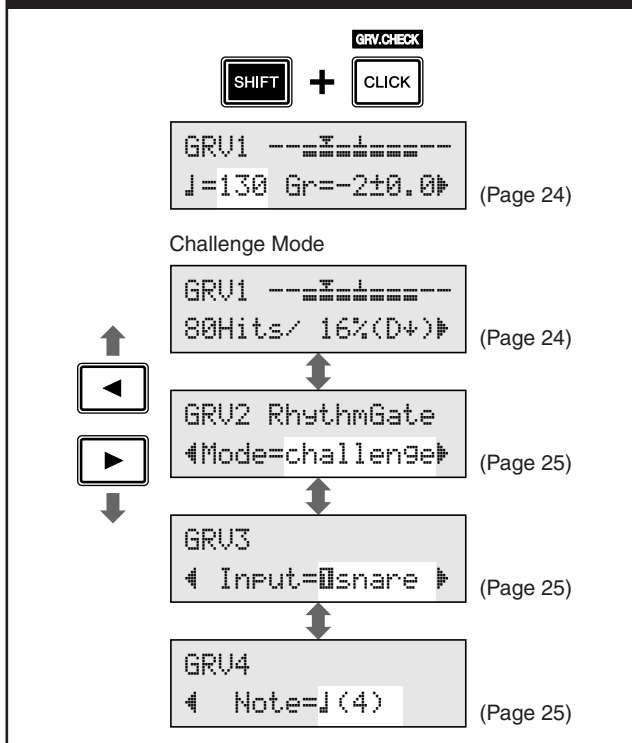

Click Settings

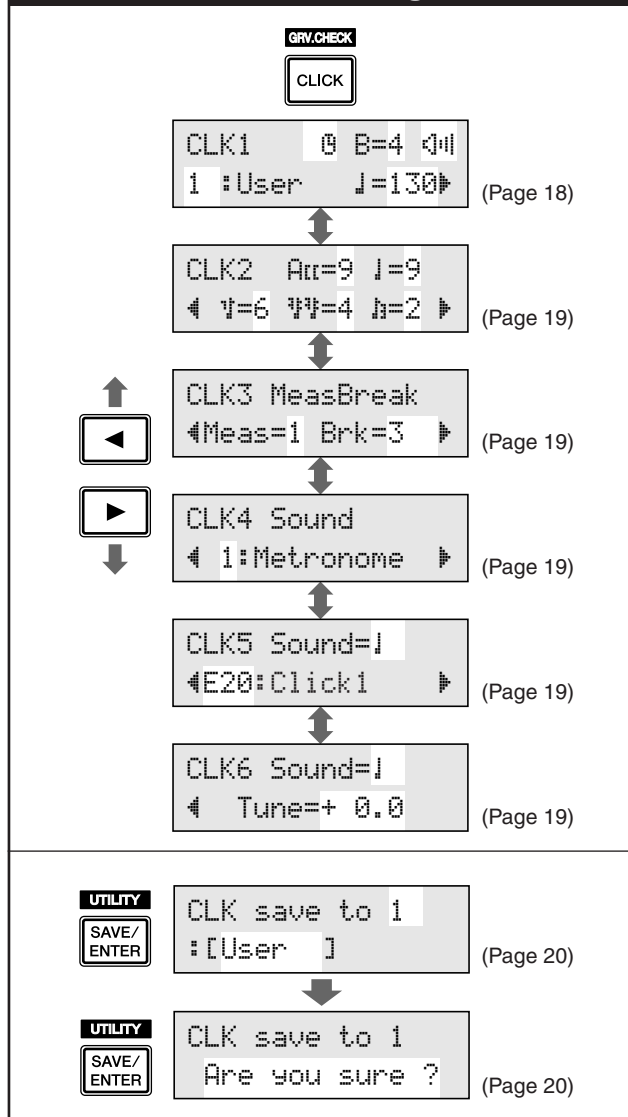

Utility Settings

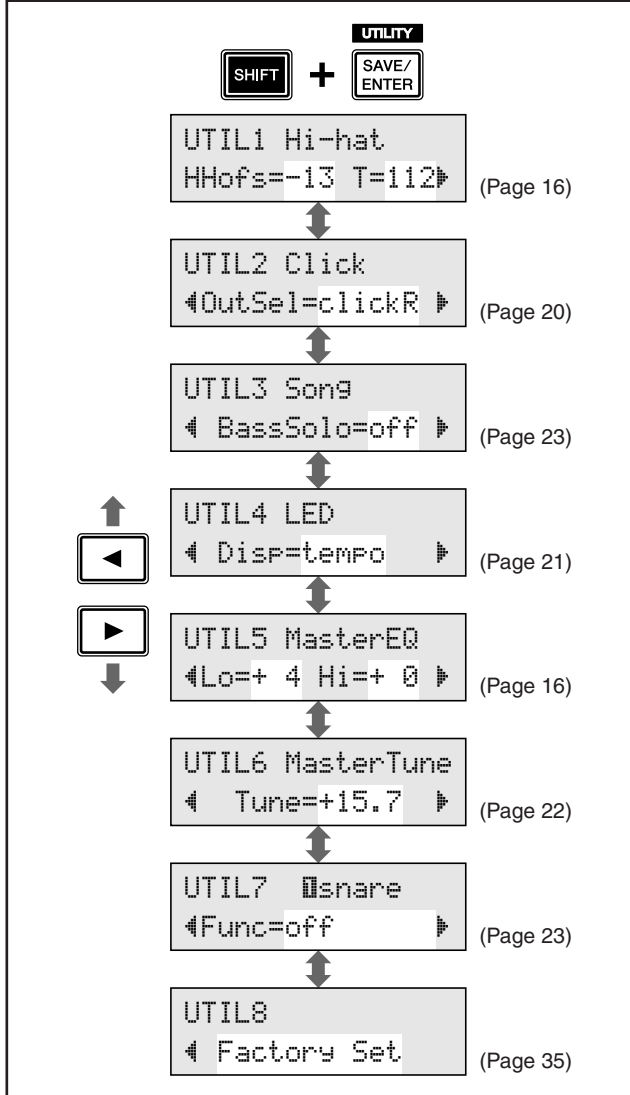

Tap Tempo Function



Trigger Setup Edit

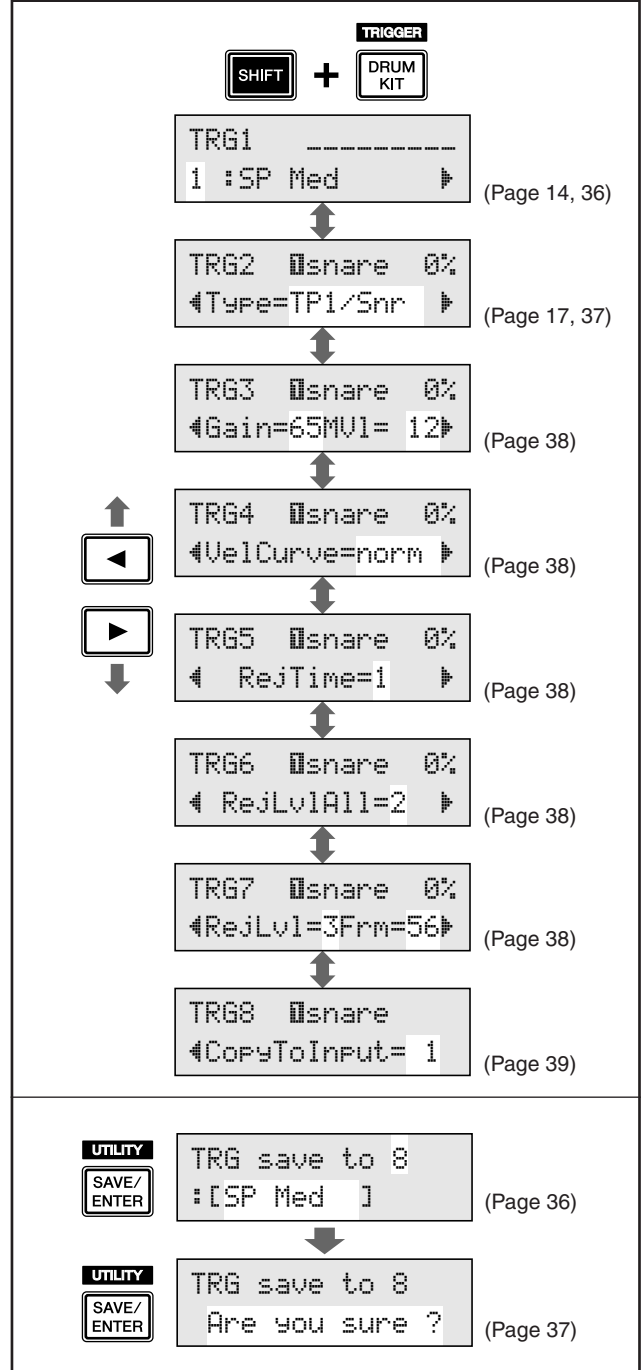

Function ...	Transmitted	Recognized	Remarks
Basic Default Channel Changed	1 - 16 1 - 16	x x	memorized
Mode Default Messages Altered	x x *****	x x x	
Note Number : True voice	0 - 127 *****	x x	
Velocity Note ON Note OFF	o 9nH,v=1-127 x 9nH,v=0	x x	
After Key's Touch Ch's	x x	x x	
Pitch Bender	x	x	
Control Change	0,32 4,7,10 1,2,5,6,8,11,12,13 16-19 33-63 64-84 91-95 96-101	o o x x x x x x x	Bank Select
Prog Change : True #	o 0 - 127 *****	x x	
System Exclusive	o	x	
Common : Song Pos. : Song Sel. : Tune	x x x	x x x	
System :Clock Real Time :Commands	o o	x x	
Aux :All Sound Off :Reset All Cntrls :Local ON/OFF Mes- :All Notes OFF sages:Active Sense :Reset	x o x x o x	x x x x x x	
Notes:			

Mode 1 : OMNI ON, POLY Mode 2 : OMNI ON, MONO o : Yes
 Mode 3 : OMNI OFF, POLY Mode 4 : OMNI OFF, MONO x : No

Drum Voice List

Voice Category

- K : Kick
- S : Snare
- T : Tom
- C : Cymbal
- H : Hi-hat
- P : Percussion
- E : Effect

K : Kick

- 1 OakCustom
- 2 MapleCustm
- 3 MapleVintg
- 4 Beech
- 5 BirchDry
- 6 BirchJazz
- 7 DryDeep
- 8 DryTight 1
- 9 DryTight 2
- 10 SoTight
- 11 2Head
- 12 BigSofty
- 13 RockAmb 1
- 14 RockAmb 2
- 15 BD Room 1
- 16 BD Room 2
- 17 GateKick1
- 18 GateKick2
- 19 T8 Kick
- 20 T9 Kick
- 21 CR Kick
- 22 T9 HrdAtk
- 23 T9 Long
- 24 Sm Kick
- 25 T8 Down
- 26 T9 Dist
- 27 TechKick1
- 28 TechKick2
- 29 TechKick3
- 30 BreakKick1
- 31 BreakKick2
- 32 BreakKick3
- 33 BreakKick4
- 34 BreakKick5
- 35 BreakKick6
- 36 VoxKick
- 37 KickBass
- 38 ResoKick1
- 39 ResoKick2
- 40 DidgerKick
- 41 ReversBD

S : Snare

- 1 OakCustom
- 2 OakCusOpRm
- 3 OakCusClRm
- 4 OakCusOff
- 5 OakCusOffO
- 6 OakCusOffC
- 7 MapleCustm
- 8 MapCusOpRm
- 9 MapCusClRm
- 10 MplCusOff
- 11 MplCusOffO
- 12 MplCusOffC
- 13 Beech
- 14 BeechOpRim
- 15 BeechClRim
- 16 BeechOff
- 17 BeechOffOR
- 18 BeechOffCR
- 19 Metal
- 20 MetalOpRim

- 21 MetalClRim
- 22 MetalOff
- 23 MetalOffOp
- 24 MetalOffCl
- 25 MapleVtg
- 26 MapleVtgR
- 27 Loosy
- 28 LoosyRim
- 29 LiteWood
- 30 LiteWoodRm
- 31 RockAmb 1
- 32 RockAmb 2
- 33 RockAmb R
- 34 BirchDeep
- 35 BirchDeepR
- 36 Studio
- 37 StudioRim
- 38 MapleLite
- 39 MapleLiteR
- 40 DryMute
- 41 Brush
- 42 BrushRim
- 43 BrushOff
- 44 BrshOffRim
- 45 SnareRoll*
- 46 GateSnare1
- 47 GateSnare2
- 48 GateSnare3
- 49 GateSnare4
- 50 GateSnare5
- 51 T8 Snare1
- 52 T8 Snare2
- 53 T8 Rim
- 54 T9 Rim
- 55 Tek Snare
- 56 LoBitSnare
- 57 Sm Snare1
- 58 Sm Snare2
- 59 SynSnare
- 60 BreakSnr 1
- 61 BreakSnr 2
- 62 BreakSnr 3
- 63 BreakSnr 4
- 64 DB Snare1
- 65 DB Snare2
- 66 DB Snare3
- 67 DB Snare4
- 68 DB Snare5
- 69 DB Snare6
- 70 Snappy
- 71 R&BSnare1
- 72 R&BSnare2
- 73 R&BSnare3
- 74 VoxSnare1
- 75 VoxSnare2
- 76 GunSnare
- 77 ResoSnare1
- 78 ResoSnare2

T : Tom

- 1 OakCustomH
- 2 OakCustomM
- 3 OakCustomL
- 4 MapleCus H
- 5 MapleCus M
- 6 MapleCus L
- 7 BeechCus H
- 8 BeechCus M
- 9 BeechCus L
- 10 Studio H
- 11 Studio M
- 12 Studio L
- 13 RockAmb H
- 14 RockAmb M
- 15 RockAmb L

- 16 MapleAmb H
- 17 MapleAmb M
- 18 MapleAmb L
- 19 JazzTom H
- 20 JazzTom M
- 21 JazzTom L
- 22 BrushTom H
- 23 BrushTom M
- 24 BrushTom L
- 25 T8 Tom1 H
- 26 T8 Tom1 M
- 27 T8 Tom1 L
- 28 T8 Tom2 H
- 29 T8 Tom2 M
- 30 T8 Tom2 L
- 31 T9 Tom1 H
- 32 T9 Tom1 M
- 33 T9 Tom1 L
- 34 T9 Tom2 H
- 35 T9 Tom2 M
- 36 T9 Tom2 L
- 37 Sm Tom1 H
- 38 Sm Tom1 M
- 39 Sm Tom1 L
- 40 Sm Tom2 H
- 41 Sm Tom2 M
- 42 Sm Tom2 L
- 43 PulseTom H
- 44 PulseTom M
- 45 PulseTom L
- 46 VoxTom
- 47 E.BendTom
- 48 E.Talking
- 49 DidgeriTom
- 50 ReverseTom

C : Cymbal

- 1 Bright18
- 2 Bright18Eg
- 3 Bright18Cp
- 4 Warm16
- 5 Warm16Edge
- 6 Warm16Cup
- 7 Dark18
- 8 Dark18Edge
- 9 Dark18Cup
- 10 CrCustom17
- 11 CrLight17
- 12 CrFast16
- 13 CrFast14
- 14 Bright20
- 15 Bright20Eg
- 16 Bright20Cp
- 17 Warm20
- 18 Warm20Edge
- 19 Warm20Cup
- 20 Dark20
- 21 Dark20Edge
- 22 Dark20Cup
- 23 RideCool
- 24 RideCoolCp
- 25 RideDry
- 26 RideDryCup
- 27 SizzleRide
- 28 SizzRideEg
- 29 SizzRideCp
- 30 ChinaHi
- 31 ChinaLoCtr
- 32 ChinaLoEg
- 33 Splash 1
- 34 Splash 2
- 35 Trash 1
- 36 Trash 2
- 37 T8 Crash
- 38 T9 Crash

- 39 T8 Ride
- 40 T9 Ride
- 41 ElecCymbal
- 42 NoiseCym1
- 43 NoiseCym2
- 44 VoxCymbal1
- 45 VoxCymbal2
- 46 ReverseCym

H : Hi-Hat

- 1 Dark14 Opn
- 2 Dark14 OpE
- 3 Dark14 Cls
- 4 Dark14 ClE
- 5 Dark14 Ft
- 6 Dark14 Sp
- 7 Dark13 Opn
- 8 Dark13 OpE
- 9 Dark13 Cls
- 10 Dark13 ClE
- 11 Dark13 Ft
- 12 Dark13 Sp
- 13 Bright14Op
- 14 Bright14OE
- 15 Bright14Cl
- 16 Bright14CE
- 17 Bright14Ft
- 18 Bright14Sp
- 19 Warm13Opn
- 20 Warm13OpE
- 21 Warm13Cls
- 22 Warm13ClE
- 23 Warm13Ft
- 24 Warm13Sp
- 25 Tight12Opn
- 26 Tight12OpE
- 27 Tight12Cls
- 28 Tight12ClE
- 29 Tight12Ft
- 30 Tight12Sp
- 31 T8 HH Opn
- 32 T8 HH Cls
- 33 T9 HH Opn
- 34 T9 HH Cls
- 35 CR HH Opn
- 36 CR HH Cls
- 37 Break HHOp
- 38 Break HHCl
- 39 Brack HHFt
- 40 NoiseHHOpn
- 41 NoiseHHCls

P : Percussion

- 1 CongaHiOpn
- 2 CongaHiSlp
- 3 CongaHiOSw
- 4 CongaHiTip
- 5 CongaHiHel
- 6 CongaLoOpn
- 7 BongoHi
- 8 BongoLo
- 9 TimbalHi
- 10 TimbalLo
- 11 PailaHi
- 12 PailaLo
- 13 SurdoOpn
- 14 SurdoMt
- 15 SurdoHO
- 16 SurdoSw
- 17 PandieroOp
- 18 PandieroMt
- 19 PandieroSl
- 20 Tambarin1
- 21 Tambarin2
- 22 Tambarin3

- 23 Cowbell 1
- 24 Cowbell 2
- 25 Cowbell 3
- 26 Cowbell3Mt
- 27 Cowbell 4
- 28 Cowbell4Mt
- 29 Claves
- 30 Maracas
- 31 Vibraslap
- 32 Castanet
- 33 TriangleOp
- 34 TriangleCl
- 35 TriangleHO
- 36 TriangleSw
- 37 GuiroShort
- 38 GuiroLong
- 39 Agogo Hi
- 40 Agogo Lo
- 41 WoodBlockH
- 42 WoodBlockL
- 43 Shaker1
- 44 Shaker2
- 45 Caxixi 1
- 46 Caxixi 2
- 47 DjembeOpen
- 48 DjembeSlap
- 49 DjembeMute
- 50 CajonLo
- 51 CajonHi
- 52 CajonSlp
- 53 TalkDrOp
- 54 TalkDrMt
- 55 TalkDrSlp
- 56 TalkDrBend
- 57 PotDrOpn
- 58 PotDrCls
- 59 PotDrMute
- 60 PotDrBody
- 61 TablaOpen1
- 62 TablaOpen2
- 63 TablaMute
- 64 TablaSlp
- 65 BayaOpn
- 66 BayaMute
- 67 BayaBend
- 68 CuicaHi
- 69 CuicaLo
- 70 WhistleH
- 71 WhistleL
- 72 SleighBell
- 73 BellTree
- 74 WindChime
- 75 TimpaniF#2
- 76 Timpani B1
- 77 Timpani E1
- 78 ConctBDop
- 79 ConctBDmt
- 80 HandCymOp
- 81 HandCymMt
- 82 Gong
- 83 ChinaGong
- 84 Odaiko
- 85 OdaikoRim
- 86 Yagura
- 87 YaguraRim
- 88 Shimedaiko
- 89 ShimeRim
- 90 Atarigane
- 91 AtariganeM
- 92 AnaConga
- 93 AnaCowbell
- 94 AnaMaracas
- 95 AnaShaker1
- 96 AnaShaker2

E : Effect

1	StickHit1	15	Noise 2	31	Scratch4	47	Glass	63	Boyon
2	StickHit2	16	Pulse	32	Scratch5	48	GunShot1	64	Pl
3	FingerSnap	17	Zap	33	Scratch6	49	GunShot2	65	E.Bass
4	E.Clap1	18	MetrBell 1	34	Scratch7	50	Bomb	66	SlapBass
5	E.Clap2	19	MetrBell 2	35	OrchHit1	51	ResoNzClap	67	Turntable*
6	E.Clap3	20	Click1	36	OrchHit2	52	Strike	68	Train*
7	NoiseHit	21	Click2	37	R&BHit1	53	AmbientCym	69	Helicopt*
8	Metal1	22	Vo Go!	38	R&BHit2	54	SFXCymbal1	70	Applause*
9	Metal2	23	Vo Hoo!	39	BrassHit	55	SFXCymbal2	71	Police*
10	Metal3	24	Vo Yoo!	40	ScratchHit	56	SFXCymbal3	72	Ring*
11	AmbShot	25	Vo Ha!	41	Industry	57	NzAmbient	73	FX Pad*
12	Tunnel	26	Vo Uh!	42	CompuVoice	58	LoDroneAmb	74	Didgerido*
13	HiQ	27	Vo aYeah!	43	Radio	59	NzEcho	75	VinylMan*
14	Noise 1	28	Scratch1	44	Thunder	60	Vel-Decay1		
		29	Scratch2	45	Tire	61	Vel-Decay2		
		30	Scratch3	46	Crash	62	DlyScratch		

* Loop

Preset Drum Kit List

No.	Name	No.	Name	No.	Name	No.	Name
1	Oak Custom	14	T8 Kit	27	Matsuri	40	WikkidPocket
2	Maple Custom	15	T9 Kit	28	AsianGypsy	41	Reggae Kit
3	Beech Custom	16	Drum&Bass	29	LoopLoop	42	BrokenFunk
4	Rock Kit	17	Electro	30	Scratch	43	GoGo1988
5	Gate Kit	18	Percuss Kit	31	VOX Kit	44	Re-0
6	Hip Hop	19	Social Cuban	32	Vintage Kit	45	Elec 5/4
7	Break Kit	20	SE Kit	33	Room Kit	46	Backbone
8	Street Beat	21	Funky Men	34	Afro Kit	47	Groove Kit
9	Brazil Kit	22	Power Kit	35	Latin Club	48	8/8 Craze
10	Sm Kit	23	Resonance	36	Drum Corps	49	Bs.@Base
11	Studio Kit	24	Industry	37	Orchestra	50	GM Standard
12	Dry Beat	25	Jazz Kit	38	See View		
13	SessionMastr	26	Brush Kit	39	Boyon		

Preset Song List

No.	Genre	Name	No.	Genre	Name	No.	Genre	Name
1	Demo	Demo 1	22	Dance	Dance 1	43	Second Line	2ndLine
2		Demo 2	23		Dance 2	44	Ska	Ska
3		Demo 3	24	Pops	Pops 1	45	Pad Song	8Craze A
4	Rock	Rock 1	25		Pops 2	46		8Craze B
5		Rock 2	26	Pop Rock	PopRock1	47		BassGrv
6		Rock 3	27		PopRock2	48		HornGrv
7		Rock 4	28	Jazz	Jazz 1	49		Jko?Naa
8		Rock 5	29		Jazz 2	50		PadBass
9		Rock 6	30	Bossa Nova	Bossa 1	51		GoGo Tp
10	Shuffle	Shuffle 1	31		Bossa 2	52		GoGo Br
11		Shuffle 2	32	Fusion	Fusion 1	53		GoGo Lp
12		Shuffle 3	33		Fusion 2	54		Re-O
13	Funk	Funk 1	34	Samba	Samba 1	55		BFunk A
14		Funk 2	35		Samba 2	56		BFunk B
15		Funk 3	36		Samba 3	57		BFunk C
16	Blues	Blues 1	37	Latin	Latin 1	58		Elec5/4A
17		Blues 2	38		Latin 2	59		Elec5/4B
18	Hip Hop	HipHop 1	39	Reggae	Reggae	60		Elec5/4C
19		HipHop 2	40	Soul	Soul	61		Backb Ld
20	R&B	R&B 1	41	Ballad	Ballad 1	62		Backb St
21		R&B 2	42		Ballad 2	63		Backb Pf

Specifications

Tone Generator block	Tone Generator	AWM2
	Maximum Polyphony	32
	Voices	427 Drum, Percussion Voices 22 Keyboard Voices
	Drum Kits	Preset: 50 User: 20
	Effects	Reverb x 19 types, Master EQ
Trigger	Trigger Setups	Preset: 7 User: 4
	Pad Controller	Snares adjustment, Tuning, Tempo
	Pad Functions	Drum Kit INC/DEC, Click Set INC/DEC, Tempo INC/DEC, Click ON/OFF
	Pad Songs	Start/Stop, Chase, Cut Off 3 songs (max.) can be played simultaneously.
Sequencer	Note Capacity	Approx. 16,000 notes
	Note Resolution	96 parts per quarter note
	Recording Type	Real Time Replace
	Track	1
	Songs	3 Demo Songs 41 Practice Songs 19 Pad Songs 20 User Songs
Metronome	Tempo	30–300 beats/minute, Tap Tempo function
	Beat	1–9
	Timing	Accent, Quarter note, Eighth note, Sixteenth note, Triplet
	Click Sound Sets	Preset: 6 User: 1
	Click Sets	30
	Click Timer	0–600 seconds (in 30-second steps)
	Training Functions	Measure Break, Groove Check, Rhythm Gate
Others	Controls	Buttons: DRUMKIT, CLICK, SONG ▶/■, SHIFT, ◀, ▶, 🗑️ ON/OFF, SAVE/ENTER Controllers: Volume, Jog Dial
	Displays	16 characters x 2 lines backlit LCD, 7-segment LED (3-digit), Tempo LED x 2
	Connectors	Trigger inputs 1, 5, 6, 7 (stereo phone jack L: trigger input, R: rim switch) Trigger inputs 2, 3, 4, 8 (stereo phone jack L: trigger input, R: trigger input) HI HAT CONTROL (stereo phone jack) OUTPUT L/MONO, R (mono phone jack) PHONES (stereo phone jack), AUX IN (stereo mini jack) MIDI OUT, DC IN
	Power Consumption	8.0W(DT XP4), 13.0W(DT XP4 and AC power adapter)
	Dimensions (W x D x H)	252 x 147 x 52 mm (9-15/16" x 5-13/16" x 2-1/16")
	Weight	898 g (2 lbs.)

* Specifications and descriptions in this owner's manual are for information purposes only. Yamaha Corp. reserves the right to change or modify products or specifications at any time without prior notice. Since specifications, equipment or options may not be the same in every locale, please check with your Yamaha dealer.

FCC INFORMATION (U.S.A.)

1. IMPORTANT NOTICE: DO NOT MODIFY THIS UNIT!

This product, when installed as indicated in the instructions contained in this manual, meets FCC requirements. Modifications not expressly approved by Yamaha may void your authority, granted by the FCC, to use the product.

2. IMPORTANT: When connecting this product to accessories and/or another product use only high quality shielded cables. Cable/s supplied with this product MUST be used. Follow all installation instructions. Failure to follow instructions could void your FCC authorization to use this product in the USA.

3. NOTE: This product has been tested and found to comply with the requirements listed in FCC Regulations, Part 15 for Class "B" digital devices. Compliance with these requirements provides a reasonable level of assurance that your use of this product in a residential environment will not result in harmful interference with other electronic devices. This equipment generates/uses radio frequencies and, if not installed and used according to the instructions found in the users manual, may cause interference harmful to the operation of other electronic devices. Compliance

with FCC regulations does not guarantee that interference will not occur in all installations. If this product is found to be the source of interference, which can be determined by turning the unit "OFF" and "ON", please try to eliminate the problem by using one of the following measures:

Relocate either this product or the device that is being affected by the interference.

Utilize power outlets that are on different branch (circuit breaker or fuse) circuits or install AC line filter/s.

In the case of radio or TV interference, relocate/reorient the antenna. If the antenna lead-in is 300 ohm ribbon lead, change the lead-in to co-axial type cable.

If these corrective measures do not produce satisfactory results, please contact the local retailer authorized to distribute this type of product. If you can not locate the appropriate retailer, please contact Yamaha Corporation of America, Electronic Service Division, 6600 Orangethorpe Ave, Buena Park, CA90620
The above statements apply ONLY to those products distributed by Yamaha Corporation of America or its subsidiaries.

* This applies only to products distributed by YAMAHA CORPORATION OF AMERICA.

(class B)

IMPORTANT NOTICE FOR THE UNITED KINGDOM

Connecting the Plug and Cord

IMPORTANT. The wires in this mains lead are coloured in accordance with the following code:

BLUE : NEUTRAL

BROWN : LIVE

As the colours of the wires in the mains lead of this apparatus may not correspond with the coloured markings identifying the terminals in your plug proceed as follows:

The wire which is coloured BLUE must be connected to the terminal which is marked with the letter N or coloured BLACK.

The wire which is coloured BROWN must be connected to the terminal which is marked with the letter L or coloured RED.

Making sure that neither core is connected to the earth terminal of the three pin plug.

• This applies only to products distributed by Yamaha-Kemble Music (U.K.) Ltd.

(2 wires)

For details of products, please contact your nearest Yamaha representative or the authorized distributor listed below.
Pour plus de détails sur les produits, veuillez-vous adresser à Yamaha ou au distributeur le plus proche de vous figurant dans la liste suivante.

Die Einzelheiten zu Produkten sind bei Ihrer unten aufgeführten Niederlassung und bei Yamaha Vertragshändlern in den jeweiligen Bestimmungsländern erhältlich.

Para detalles sobre productos, contacte su tienda Yamaha más cercana o el distribuidor autorizado que se lista debajo.

NORTH AMERICA

CANADA

Yamaha Canada Music Ltd.
135 Milner Avenue, Scarborough, Ontario,
M1S 3R1, Canada
Tel: 416-298-1311

U.S.A.

Yamaha Corporation of America
6600 Orangethorpe Ave., Buena Park, Calif. 90620,
U.S.A.
Tel: 714-522-9011

CENTRAL & SOUTH AMERICA

MEXICO

Yamaha de México S.A. de C.V.
Calz. Javier Rojo Gómez #1149,
Col. Guadalupe del Moral
C.P. 09300, México, D.F., México
Tel: 55-5804-0600

BRAZIL

Yamaha Musical do Brasil Ltda.
Rua Joaquim Floriano, 913 - 4º andar, Itaim Bibi,
CEP 04534-013 Sao Paulo, SP. BRAZIL
Tel: 011-3704-1377

ARGENTINA

Yamaha Music Latin America, S.A.
Sucursal de Argentina
Olga Cossetini 1553, Piso 4 Norte
Madero Este-C1107CEK
Buenos Aires, Argentina
Tel: 011-4119-7000

PANAMA AND OTHER LATIN AMERICAN COUNTRIES/ CARIBBEAN COUNTRIES

Yamaha Music Latin America, S.A.
Torre Banco General, Piso 7, Urbanización Marbella,
Calle 47 y Aquilino de la Guardia,
Ciudad de Panamá, Panamá
Tel: +507-269-5311

EUROPE

THE UNITED KINGDOM/IRELAND

Yamaha Music U.K. Ltd.
Sherbourne Drive, Tilbrook, Milton Keynes,
MK7 8BL, England
Tel: 01908-366700

GERMANY

Yamaha Music Europe GmbH
Siemensstraße 22-34, 25462 Rellingen, Germany
Tel: 04101-3030

SWITZERLAND/LIECHTENSTEIN

Yamaha Music Europe GmbH
Branch Switzerland in Zürich
Seefeldstrasse 94, 8008 Zürich, Switzerland
Tel: 01-383 3990

AUSTRIA

Yamaha Music Europe GmbH Branch Austria
Schleiergasse 20, A-1100 Wien, Austria
Tel: 01-60203900

CZECH REPUBLIC/SLOVAKIA/ HUNGARY/SLOVENIA

Yamaha Music Europe GmbH Branch Austria
Schleiergasse 20, A-1100 Wien, Austria
Tel: 01-602039025

POLAND

Yamaha Music Europe GmbH
Branch Sp.z o.o. Oddział w Polsce
ul. 17 Stycznia 56, PL-02-146 Warszawa, Poland
Tel: 022-868-07-57

THE NETHERLANDS/ BELGIUM/LUXEMBOURG

Yamaha Music Europe Branch Benelux
Clarissenhof 5-b, 4133 AB Vianen, The Netherlands
Tel: 0347-358 040

FRANCE

Yamaha Musique France
BP 70-77312 Marne-la-Vallée Cedex 2, France
Tel: 01-64-61-4000

ITALY

Yamaha Musica Italia S.P.A.
Combo Division
Viale Italia 88, 20020 Lainate (Milano), Italy
Tel: 02-935-771

SPAIN/PORTUGAL

Yamaha Música Ibérica, S.A.
Ctra. de la Coruna km. 17, 200, 28230
Las Rozas (Madrid), Spain
Tel: 91-639-8888

GREECE

Philippos Nakas S.A. The Music House
147 Skiathou Street, 112-55 Athens, Greece
Tel: 01-228 2160

SWEDEN

Yamaha Scandinavia AB
J. A. Wettergrens Gata 1, Box 30053
S-400 43 Göteborg, Sweden
Tel: 031 89 34 00

DENMARK

YS Copenhagen Liaison Office
Generatorvej 6A, DK-2730 Herlev, Denmark
Tel: 44 92 49 00

FINLAND

F-Musiikki Oy
Kluuvikatu 6, P.O. Box 260,
SF-00101 Helsinki, Finland
Tel: 09 618511

NORWAY

Norsk filial av Yamaha Scandinavia AB
Grini Næringspark 1, N-1345 Østerås, Norway
Tel: 67 16 77 70

ICELAND

Skifan HF
Skeifan 17 P.O. Box 8120, IS-128 Reykjavik, Iceland
Tel: 525 5000

RUSSIA

Yamaha Music (Russia)
Office 4015, entrance 2, 21/5 Kuznetskii
Most street, Moscow, 107996, Russia
Tel: 495 626 0660

OTHER EUROPEAN COUNTRIES

Yamaha Music Europe GmbH
Siemensstraße 22-34, 25462 Rellingen, Germany
Tel: +49-4101-3030

AFRICA

Yamaha Corporation,
Asia-Pacific Music Marketing Group
Nakazawa-cho 10-1, Naka-ku, Hamamatsu,
Japan 430-8650
Tel: +81-53-460-2312

MIDDLE EAST

TURKEY/CYPRUS

Yamaha Music Europe GmbH
Siemensstraße 22-34, 25462 Rellingen, Germany
Tel: 04101-3030

OTHER COUNTRIES

Yamaha Music Gulf FZE
LOB 16-513, P.O.Box 17328, Jubel Ali,
Dubai, United Arab Emirates
Tel: +971-4-881-5868

ASIA

THE PEOPLE'S REPUBLIC OF CHINA

Yamaha Music & Electronics (China) Co., Ltd.
2F, Yunhedasha, 1818 Xinzha-lu, Jingan-qu,
Shanghai, China
Tel: 021-6247-2211

HONG KONG

Tom Lee Music Co., Ltd.
11/F, Silvercord Tower 1, 30 Canton Road,
Tsimshatsui, Kowloon, Hong Kong
Tel: 2737-7688

INDIA

Yamaha Music India Pvt. Ltd.
5F Ambience Corporate Tower Ambience Mall Complex
Ambience Island, NH-8, Gurgaon-122001, Haryana, India
Tel: 0124-466-5551

INDONESIA

PT. Yamaha Music Indonesia (Distributor)
PT. Nusantik
Gedung Yamaha Music Center, Jalan Jend. Gatot
Subroto Kav. 4, Jakarta 12930, Indonesia
Tel: 21-520-2577

KOREA

Yamaha Music Korea Ltd.
8F, 9F, Dongsung Bldg. 158-9 Samsung-Dong,
Kangnam-Gu, Seoul, Korea
Tel: 080-004-0022

MALAYSIA

Yamaha Music Malaysia, Sdn., Bhd.
Lot 8, Jalan Perbandaran, 47301 Kelana Jaya,
Petaling Jaya, Selangor, Malaysia
Tel: 3-78030900

PHILIPPINES

Yupangco Music Corporation
339 Gil J. Puyat Avenue, P.O. Box 885 MCPO,
Makati, Metro Manila, Philippines
Tel: 819-7551

SINGAPORE

Yamaha Music Asia Pte., Ltd.
#03-11 A-Z Building
140 Paya Lebar Road, Singapore 409015
Tel: 747-4374

TAIWAN

Yamaha KHS Music Co., Ltd.
3F, #6, Sec.2, Nan Jing E. Rd. Taipei.
Taiwan 104, R.O.C.
Tel: 02-2511-8688

THAILAND

Siam Music Yamaha Co., Ltd.
4, 6, 15 and 16th floor, Siam Motors Building,
891/1 Rama 1 Road, Wangmai,
Pathumwan, Bangkok 10330, Thailand
Tel: 02-215-2626

OTHER ASIAN COUNTRIES

Yamaha Corporation,
Asia-Pacific Music Marketing Group
Nakazawa-cho 10-1, Naka-ku, Hamamatsu,
Japan 430-8650
Tel: +81-53-460-2317

OCEANIA

AUSTRALIA

Yamaha Music Australia Pty. Ltd.
Level 1, 99 Queensbridge Street, Southbank,
Victoria 3006, Australia
Tel: 3-9693-5111

NEW ZEALAND

Music Works LTD
P.O. BOX 6246 Wellesley, Auckland 4680,
New Zealand
Tel: 9-634-0099

COUNTRIES AND TRUST TERRITORIES IN PACIFIC OCEAN

Yamaha Corporation,
Asia-Pacific Music Marketing Group
Nakazawa-cho 10-1, Naka-ku, Hamamatsu,
Japan 430-8650
Tel: +81-53-460-2312

SY49

HEAD OFFICE Yamaha Corporation, Pro Audio & Digital Musical Instrument Division
Nakazawa-cho 10-1, Naka-ku, Hamamatsu, Japan 430-8650
Tel: +81-53-460-2445

Yamaha Drums global web site:
<http://www.global.yamaha.com/products/music/drums.html>

Yamaha Manual Library
<http://www.yamaha.co.jp/manual/>

U.R.G., Pro Audio & Digital Musical Instrument Division, Yamaha Corporation
© 2006 Yamaha Corporation



WR29770 8??POAP?.?-04D0
Printed in China