



MusicCast 200

Desktop Audio System

**TSX-N237**

**TSX-N237D**

**EN** Owner's Manual

# Table of contents

<b>Introduction .....</b>	<b>3</b>
Accessories .....	3
About this document .....	3
<b>Using the unit .....</b>	<b>4</b>
<b>Part names .....</b>	<b>5</b>
The unit .....	5
Display .....	6
Remote control .....	7
<b>Preparation .....</b>	<b>9</b>
Turn on the unit .....	9
Set the unit's clock .....	10
🌐 Use MusicCast Controller to connect to a network .....	11
<b>Play from an input source .....</b>	<b>12</b>
Listening to a CD .....	12
Listening to music via Bluetooth® .....	13
Listening to DAB stations (Australia, U.K., and Europe models only) .....	16
Listening to FM radio stations .....	19
Listening to music on USB flash drives .....	21
Listening to music from an external device .....	22
Listening to music stored on the mobile device .....	23
🌐 Listening to Internet radio .....	24
🌐 Listening to streaming services .....	25
🌐 Listening to music stored on a media server (computer or NAS) .....	26
🌐 Listening to music via AirPlay 2 .....	27
<b>Other features .....</b>	<b>28</b>
Shuffle/repeat playback .....	28
Playback information .....	29

Adjusting sound quality .....	30
Registering favorites with SCENE .....	31
Alarm (IntelliAlarm) .....	32
Using the sleep timer .....	33
Child lock function .....	34
Charging a mobile device (Qi) .....	35
Adjusting display brightness (dimmer) .....	36
Option settings .....	37
🌐 Pair the unit with MusicCast-enabled devices .....	40
🌐 Firmware updates .....	41
🌐 Wired network connection .....	43
🌐 Using WPS (Wi-Fi Protected Setup) to connect to a network .....	44
🌐 Using iPhone settings to connect to a network .....	45
<b>Troubleshooting .....</b>	<b>46</b>
<b>Messages in the display .....</b>	<b>54</b>
<b>Devices/media, and file formats supported by the unit .....</b>	<b>55</b>
<b>Specifications .....</b>	<b>57</b>
<b>Trademarks .....</b>	<b>59</b>

Functions that require a network connection are indicated with the 🌐 icon.

Thank you for purchasing this Yamaha product.  
Before using the unit, be sure to read this document and the supplied "Safety Brochure" to ensure proper and safe use. Keep these documents readily available for future reference.

# Introduction

Confirm package contents and important information about this manual.

## Accessories



Remote control

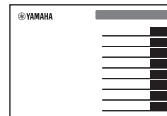

Quick Manual



Non-skid pad (☞ p. 35)

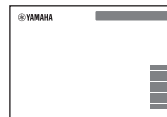

Safety Brochure

## About this document

- This document provides detailed instructions on operating the unit's functions.
- Instructions concentrate on use of the remote control to operate the unit.
- Illustrations used in the document may differ from the actual product. The clock in this document's display illustrations uses the 12-hour time format.
- In this document, smartphones and other mobile devices running the iOS or Android operating systems are collectively referred to as "mobile devices".
- Screenshots in this document were captured on a device running the English version of iOS. Actual screen displays may differ depending upon the version of the MusicCast Controller app or iOS used.
- Symbols and conventions



This content indicates "risk of serious injury or death."

### **Notice**

Indicates points that you must observe in order to prevent product failure, damage or malfunction and data loss, as well as to protect the environment.

### **Note**

Indicates notes on instructions, restrictions on functions, and additional information that may be helpful.



References another page or pages that provide additional information.

# Using the unit

- This unit is a desktop audio system that can play audio from an incredibly wide range of input sources, including CDs, Bluetooth devices, and radio stations. This unit can also be used with a home network or audio system to play audio from a media server (computer or NAS), Internet radio, or AirPlay devices on the same network.
- This unit is equipped with a convenient charging function and an alarm function that wakes you gently.
- The free dedicated MusicCast Controller app for mobile devices can be used to easily control playback or configure the unit's settings. Download the MusicCast Controller app to your mobile device from the App Store or Google Play™.

**IntelliAlarm wakes you up gently.**  
“Alarm (IntelliAlarm)” (☞ p. 32)

**Support for a broad range of input sources.**  
“Play from an input source” (☞ p. 12)

**The unit’s top panel supports wireless smartphone charging.**  
“Charging a mobile device (Qi)” (☞ p. 35)

**Bluetooth headphones allow you to listen to music, even at night, without disturbing others.**  
“Using Bluetooth speakers/headphones to listen to audio (transmitting function)” (☞ p. 15)

\* A wireless LAN router (access point) is required when using a mobile device.

# Part names

## The unit

①, ②, ③, ⑥, and ⑦ are touch sensors. Tap icons with your finger to control functions.

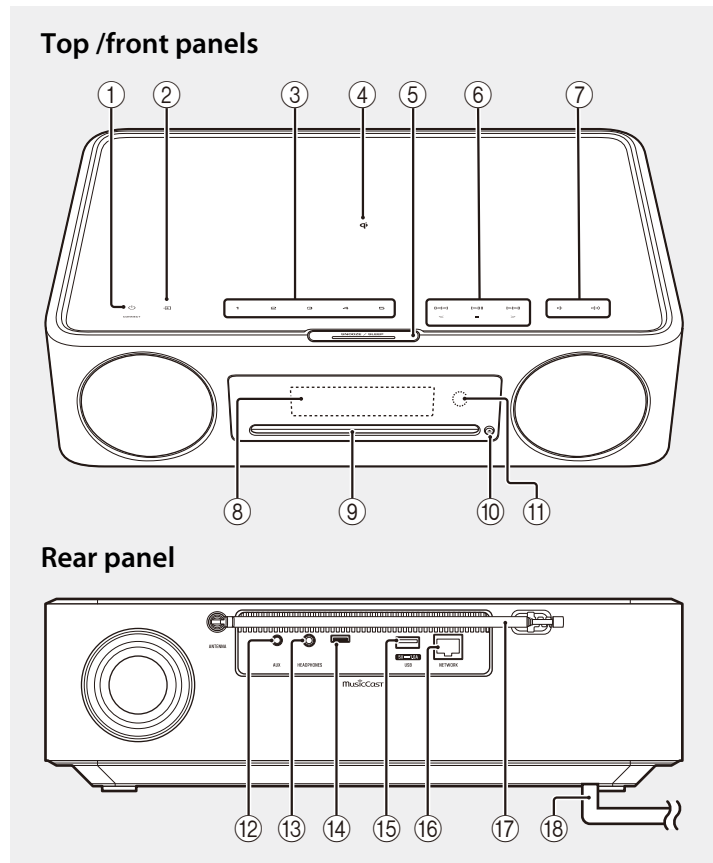

- ① Power on/standby/CONNECT (☞ p. 9, 11).
- ② Switch the input source.
- ③ **1, 2, 3, 4, 5** SCENE function (☞ p. 31)
- ④ Wireless charger (☞ p. 35)
- ⑤ SNOOZE/SLEEP (☞ p. 33)
- ⑥ Control audio (☞ p. 12, 19, 21, 24, 26).
- ⑦ Volume -/+
- ⑧ Display (☞ p. 6)
- ⑨ Disc slot (☞ p. 12)
- ⑩ Eject a disc (☞ p. 12).
- ⑪ Remote sensor
- ⑫ AUX jack (Mini jack input) (☞ p. 22)
- ⑬ HEADPHONES jack  
No sound is heard from the unit when the headphones are connected.
- ⑭ Service jack  
Used when the unit requires servicing.
- ⑮ USB jack (☞ p. 21)
- ⑯ NETWORK jack (☞ p. 43)  
The unit can be connected to a network using either a wired or a wireless connection. For a wired network connection, connect a standard shielded twisted pair (STP) network cable (straight, category 5 or higher; commercially available).
- ⑰ FM antenna for TSX-N237 (☞ p. 19)  
FM/DAB antenna for TSX-N237D (☞ p. 16)
- ⑱ Power cord (☞ p. 9)

# Display

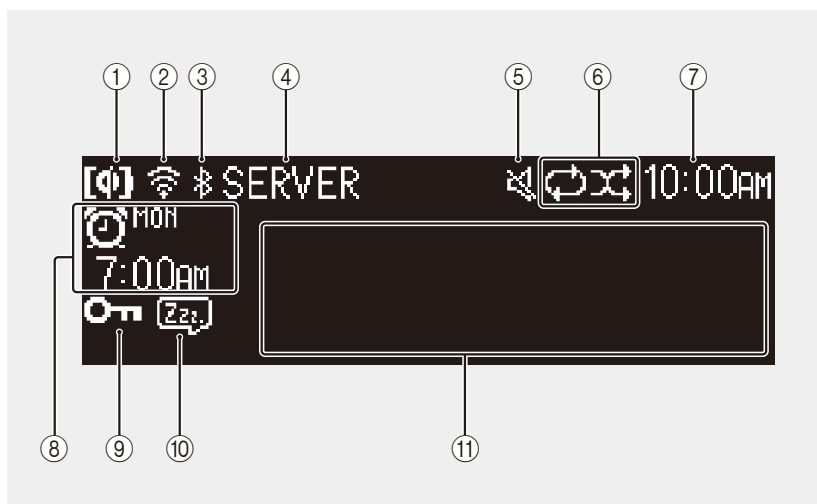

Indicators and information in the display are as follows:

- ① Qi wireless charging (☞ p. 35)
- ② Wireless LAN (☞ p. 45)  
Glow steadily when the unit is connected to a wireless LAN router via Wi-Fi.
- ③ Bluetooth (☞ p. 13)
- ④ Input source  
The selected input source is displayed.

- ⑤ Mute  
The indicator is displayed while muted.
- ⑥ Repeat, shuffle, or information about the radio station (☞ p. 28)  
When FM or DAB radio is selected as the input source, information about the radio station or broadcast is displayed (☞ p. 16, 19).
- ⑦ Current time (☞ p. 10)
- ⑧ Alarm information (☞ p. 32)
- ⑨ Child lock (☞ p. 34)
- ⑩ Sleep (☞ p. 33)
- ⑪ Info display  
Displays a variety of information, including that for a song as it plays, radio frequency, etc.  
Some information may be cut off as there is a limit on the number of characters that can be displayed.

## Note

Display brightness can be adjusted as required.

- Automatic (default setting; adjusted automatically in accordance with ambient lighting.)
- Manual (10 levels)

See "Adjusting display brightness (dimmer)" (☞ p. 36) to configure this function.

# Remote control

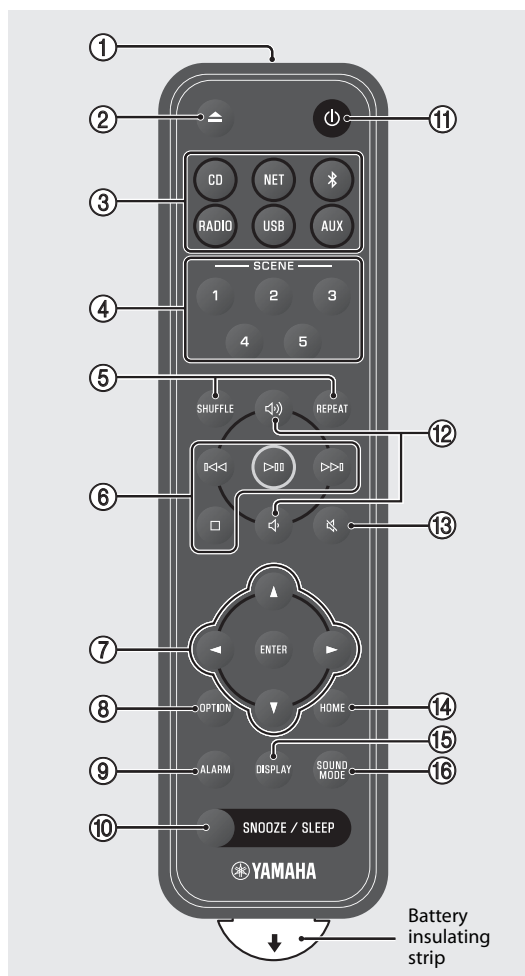

- ① Transmit infrared (IR) signals.
- ② ▲ Eject a disc (☞ p. 12).
- ③ Input sources  
Switch the input source.
- ④ SCENE function (☞ p. 31)
- ⑤ SHUFFLE/REPEAT (☞ p. 28)
- ⑥ Control audio (☞ p. 12, 16, 19, 21, 24, 26)
- ⑦ Cursor control
- ⑧ OPTION (☞ p. 37)
- ⑨ ALARM (☞ p. 32)
- ⑩ SNOOZE/SLEEP (☞ p. 33)
- ⑪ ⏻ Power on/standby (☞ p. 9).
- ⑫ 🔊/🔇 Volume +/-
- ⑬ 🔇 Mute/unmute
- ⑭ HOME (☞ p. 21, 24, 25)
- ⑮ DISPLAY (☞ p. 29)
- ⑯ SOUND MODE (☞ p. 30)

Remove the battery insulating strip before attempting to use the remote control.

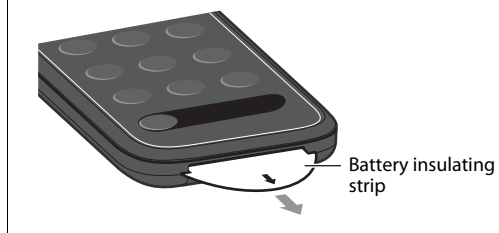

## Replacing the remote control battery

Press the release tab firmly to the right and hold it there while slowly sliding the battery holder out.

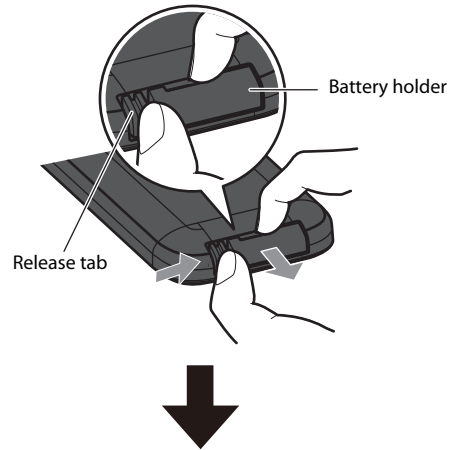

Replace the old battery with a new one.

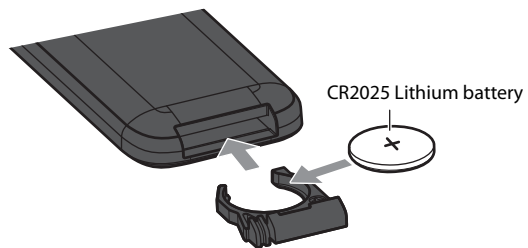

### **Note**

Replace the old battery with a new one when the remote control's range becomes very short.





# Preparation

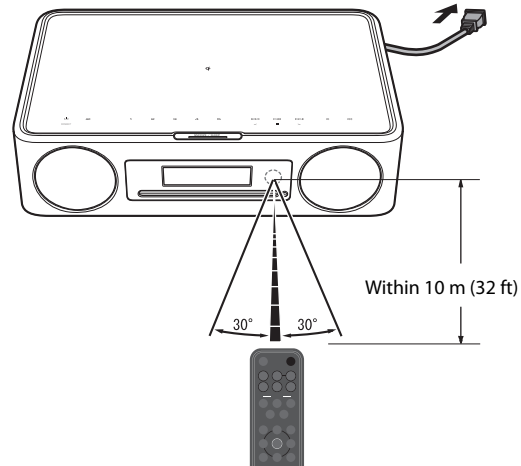

## Turn on the unit

**1** Plug the power cord into an electrical outlet.



**2** Press  to turn on the unit.

The display on the front panel will be turned on.

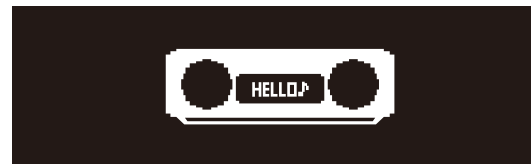

## Reducing power consumption

### Auto standby

The unit will automatically enter auto standby mode in any of the following situations:

- CD, Bluetooth, USB, or NET is selected as the input source, but no audio is played and no operations are performed for approximately 20 minutes.
- An input source other than any of those noted above is selected, but no operations are performed for approximately 8 hours.

See "Auto standby" in "Option settings" to disable the auto standby function (☞ p. 39).

## Set the unit's clock

When the MusicCast Controller app (p. 11) is used to connect the unit to a network, the unit's clock can be synchronized with that of the mobile device running MusicCast Controller. If you utilize this feature, skip the procedure described below.



### 1 Press **OPTION**.

The option menu is displayed.



### 2 Use **◀/▶** to select and press **ENTER**.

### 3 Use **▲/▼** to select **Clock setting** and press **ENTER**.

### 4 Use **▲/▼/◀/▶** to adjust the date, select the 12- or 24-hour time format, and adjust the time.

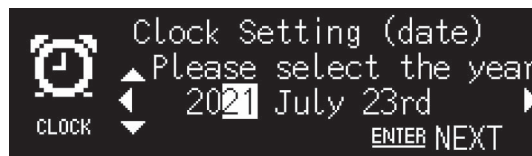

### 5 Press **ENTER** to finalize and apply clock settings.

# Use MusicCast Controller to connect to a network

- 1 Download the dedicated MusicCast Controller app to your mobile device on the App Store or Google Play.

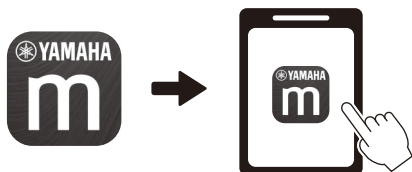

- 2 Follow the app's on-screen instructions to configure network settings.

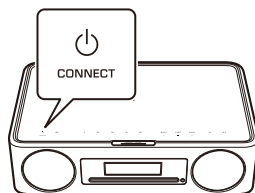
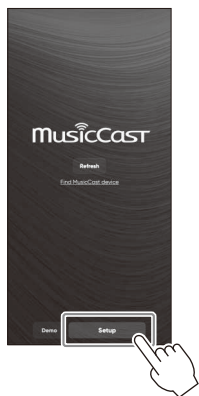

Follow the app's on-screen instructions and press CONNECT for at least five seconds.

## Note

- See the following when connecting to a network without using the MusicCast Controller app.
  - Wired network connection (☞ p. 43)
  - Using Wi-Fi Protected Setup (WPS) to connect to a network (☞ p. 44)
  - Using iPhone settings to connect to a network (☞ p. 45)
- After connecting to a network using one of the methods described above, download and install the MusicCast Controller app to your mobile device and follow the instructions at left to enable simple operation of the unit from your mobile device.
- For more information on Internet connections, refer to the documentation provided with your network devices.
- Security software installed on your computer or network device settings (firewall, etc.) may prevent the unit from accessing your computer or Internet radio stations. If this occurs, modify security software or network device settings to permit access by the unit.

## Important notice regarding information security

Visit the website shown below for details.



<https://manual.yamaha.com/av/policy/mcc/>

# Play from an input source

## Listening to a CD

1 Press **CD**.

2 Insert a CD into the disc slot.

Music begins playing. Press ▲ to eject a CD.

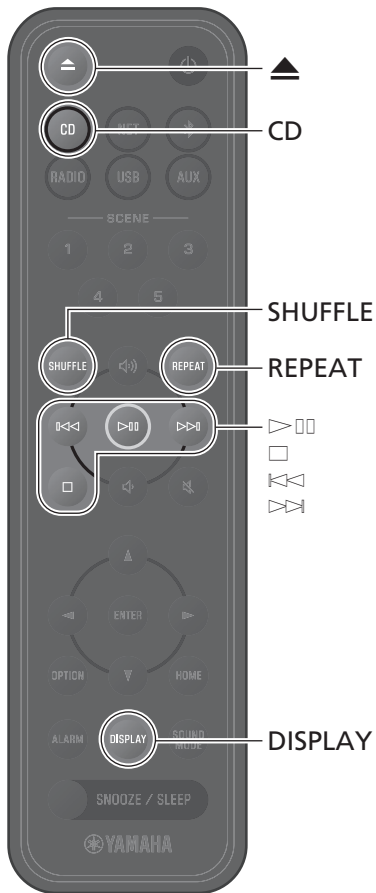
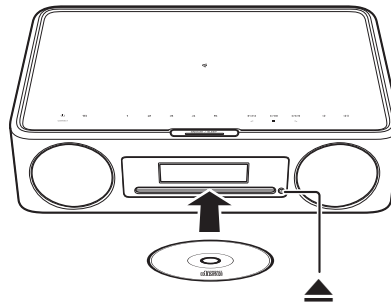

### Note

- This unit supports playback of audio and data CDs to which MP3 and or WMA files have been recorded.
- This unit does not support 8-cm mini CDs. Do not insert an 8-cm mini CD, or an adapter containing an 8-cm mini CD, into the disc slot.
- If a CD that is not supported by the unit is inserted into the disc slot, it may not be possible to eject the CD. See "Devices/media, and file formats supported by the unit" for information on CDs supported by the unit (☞ p. 55).
- When CD playback is stopped, playback will resume from the beginning of the song last played. Pressing □ while playback is stopped will clear playback memory (resume playback feature).
- If the unit is turned off when CD has been selected as the input source and a CD has been inserted into the disc slot, CD playback will automatically begin the next time the unit is turned on.
- The CD will begin playing if CD is selected as the input source with a CD loaded in the unit.

### Audio control buttons

▷ □	Play/pause
□	Stop
⏮	Skip to the beginning of the song being played or previous song. Press and hold to fast rewind.
⏭	Skip to the next song. Press and hold to fast forward.
DISPLAY	Information about an audio CD being played is displayed. (☞ p. 29)
SHUFFLE/ REPEAT	☞ p. 28



## Listening to music via Bluetooth®



The unit can be used to play music from a Bluetooth device, such as a mobile device or digital music player. In addition, Bluetooth wireless headphones or speakers can be used to listen to audio played via the unit.

For more information regarding Bluetooth, see documentation provided with Bluetooth devices.

### Note

- A Bluetooth device that transmits audio to the unit and Bluetooth speakers/headphones that receive audio from the unit cannot be connected at the same time.
- If a Bluetooth device has been connected before, the unit will connect to the last connected device. Terminate this connection to connect a new device.
- Press and hold  on the remote control or  on the unit for at least three seconds to terminate the Bluetooth connection from the unit.

### Listening to music from a Bluetooth device (receiving function)

Audio from a Bluetooth device can be played on the unit over a wireless connection.

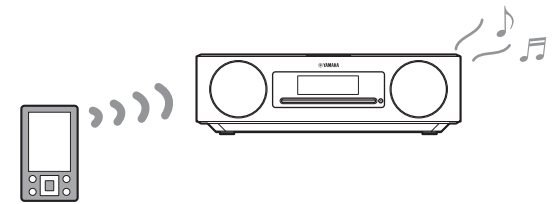

#### 1 Press .

The unit's input source is switched to Bluetooth and the unit is ready for pairing.

#### 2 Enable the Bluetooth function of the Bluetooth device.

- 3 Select this unit from the Bluetooth device list on the Bluetooth device.

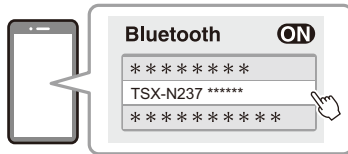

The illustration above shows an example of the display. When the unit is connected to a network using the MusicCast Controller app, the name of the room (assigned with the app) in which this unit is located is displayed.

The Bluetooth indicators will be displayed once the connection has been established.



- 4 Play a music file on the Bluetooth device.

**Note**

If a Bluetooth connection is not established, delete the unit's registration from the Bluetooth device, and then try repeating steps **1-3**.



## Using Bluetooth speakers/headphones to listen to audio (transmitting function)

Bluetooth speakers or headphones can be used to listen to audio played via the unit. This function can only be controlled using the MusicCast Controller app.

Bluetooth speakers or headphones

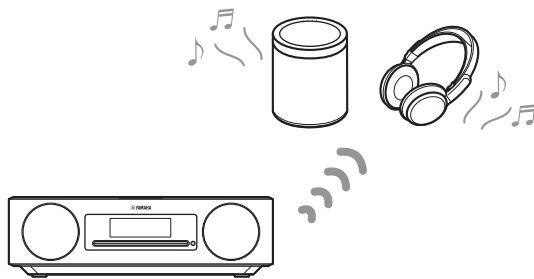

### Note

- This function cannot be used when Bluetooth is selected as the input source. Select an input source other than Bluetooth.
- Be sure to use Bluetooth speakers or headphone that are equipped with a volume control. Volume must be adjusted using the Bluetooth speakers or headphones. Volume cannot be adjusted from this unit.
- Use the volume control on the Bluetooth speakers or headphones to turn down the volume, and then connect the speakers or headphones to the unit. Failure to turn down the volume before connecting may result in extremely loud playback to begin when the Bluetooth connection is established.
- Equalizer and sound mode settings (p. 30) are not reflected when listening to audio through Bluetooth speakers or headphones.

**1** Set Bluetooth speakers or headphones to pairing mode.

**2** Use the MusicCast Controller app to select an input source.

**3** Tap  in the playback screen.

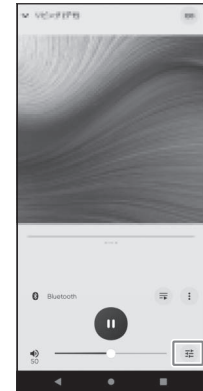

**4** Tap **Bluetooth Transmission** in the **Sound Settings** screen.

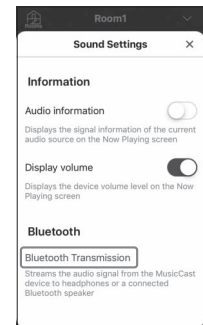

**5** Enable the **Bluetooth transmission** function in the **Bluetooth Transmission** screen.

**6** Select the Bluetooth speakers or headphones to be connected.

### Note

If a Bluetooth connection is not established, repeat the connection procedure from step **1**.

# Listening to DAB stations (Australia, U.K., and Europe models only)



## Initial scan

Press **RADIO** repeatedly to select **DAB**.

- Initial scan starts automatically when you select **DAB** for the first time.
- When scanning is completed, the number of receivable DAB stations is displayed momentarily, and the first station stored is played.

## Tuning in DAB stations

**1** Press **RADIO** repeatedly to select **DAB**.

When the unit cannot receive the DAB signal, "Off Air" is displayed.

**2** Press **◀** or **▶** to select a DAB station.

### Note

- Initial scan can also be performed from the option settings.
  - 1 Press **OPTION** when **DAB** is selected as the input source.
  - 2 Use **◀/▶** to select **DAB**, and press **ENTER**.
  - 3 Use **▲/▼** to select **Initial scan**, and press **ENTER**.  
The initial scan display is shown.
  - 4 Use **◀/▶** to select **OK**, and press **ENTER** to begin the initial scan.  
"Complete" is displayed when the initial scan is complete.
- If an initial scan is performed, stored DAB station information and preset DAB stations are cleared.
- This unit can receive only Band III DAB frequencies.

Frequency in MHz/Channel label

174.928/5A	176.640/5B	178.352/5C	180.064/5D
181.936/6A	183.648/6B	185.360/6C	187.072/6D
188.928/7A	190.640/7B	192.352/7C	194.064/7D
195.936/8A	197.648/8B	199.360/8C	201.072/8D
202.928/9A	204.640/9B	206.352/9C	208.064/9D
209.936/10A	211.648/10B	213.360/10C	215.072/10D
216.928/11A	218.640/11B	220.352/11C	222.064/11D
223.936/12A	225.648/12B	227.360/12C	229.072/12D
230.784/13A	232.496/13B	234.208/13C	235.776/13D
237.488/13E	239.200/13F		



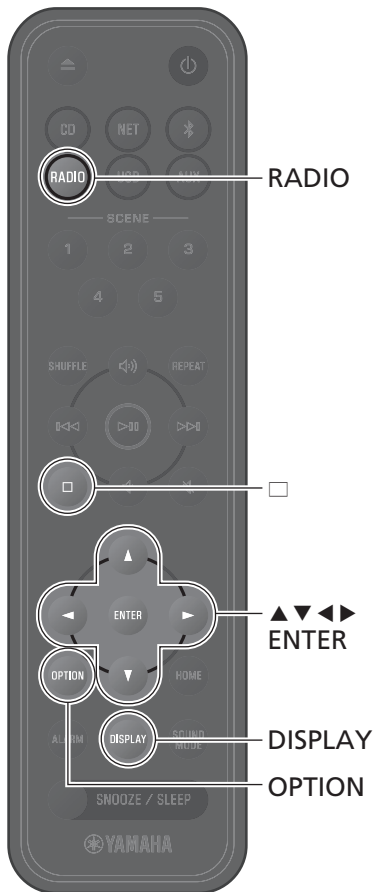

## Presetting DAB stations

Use the preset function to store your favorite 40 DAB stations.

- 1** Tune in to a DAB station (↗ p. 16).
- 2** Press and hold **ENTER**.  
The preset display is shown.
- 3** Press ▲/▼ to select the required preset number, and press **ENTER**.  
To cancel the DAB preset setting, press □.
- 4** Use ◀/▶ to select **OK**, and press **ENTER**.

## Selecting preset DAB stations

- 1** Press **RADIO** repeatedly to select **DAB**.
- 2** Press ▲/▼ to select a preset station.

### Note

DAB station information shown in the display is switched in the following order each time **DISPLAY** is pressed.

---

Station Label (up to 8 characters), Preset number (default)

---

DLS (Dynamic Label Segment)

---

Ensemble Label

---

Channel label, Frequency, Signal Quality

---

Audio format, DRC

## Deleting a preset DAB station

- 1** Press **RADIO** repeatedly to select **DAB**.
- 2** Press and hold □.  
The preset display is shown.
- 3** Use ▲/▼ to select **Delete ALL** or the preset number to be deleted, and press **ENTER**.
- 4** Use ◀/▶ to select **OK**, and press **ENTER**.
- 5** Press **OPTION** to exit the settings display.



## Confirming the reception

You can confirm the DAB signal level. This is useful when setting up the antenna.

- 1 Press **OPTION** when **DAB** is selected as the input source.
- 2 Use ◀/▶ to select , and press **ENTER**.
- 3 Use ▲/▼ to select **Tuning Aid**, and press **ENTER**.
- 4 Press ▲/▼ to change the channel label.

The Tuning Aid display is shown.

The measured DAB signal reception level is displayed.

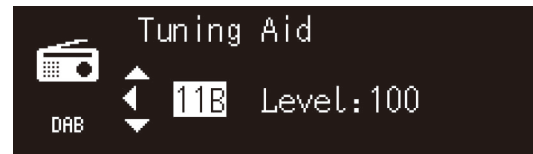

The level is from 0 (none) to 100 (best).

- 5 Press **OPTION** to exit the settings display.

### Note

When the DAB signal is weak in Tuning Aid, try adjusting the position of the antenna to obtain good reception.

# Listening to FM radio stations

Extend the antenna and position it for good FM reception.



## Tuning in to a station

- 1 Press **RADIO**.
- 2 Press and hold ◀ or ▶.

Automatic tuning starts. Tuning will stop automatically when a station is tuned in.

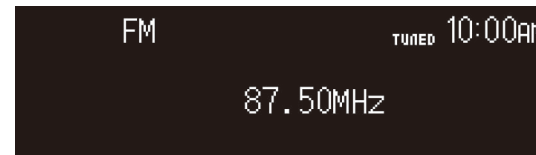

### Note

If station reception is weak, tune in to a station manually by pressing ◀/▶ repeatedly. Sound will be heard in monaural.

## Presetting stations

### Auto preset

The unit tunes in stations with good reception and presets them automatically.

- 1 Press **RADIO**.
- 2 Press **OPTION**.
- 3 Use ◀/▶ to select , and press **ENTER**.
- 4 Use ▲/▼ to select **Auto preset**, and press **ENTER**.
- 5 Use ◀/▶ to select **OK**, and press **ENTER**.

Auto preset begins. "Complete" is displayed when auto preset is complete.

### Note

- Auto preset replaces all stations currently stored with new stations.
- Up to 40 FM stations can be preset.
- Press **OPTION** to cancel auto preset.

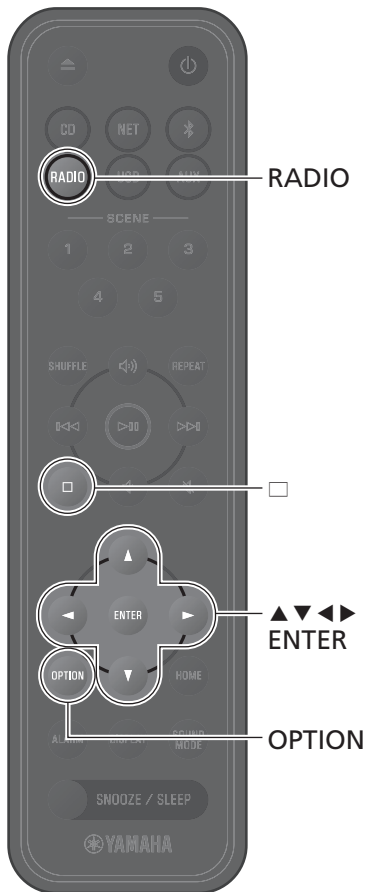

## Manual preset

**1** Tune in to a station (🔊 p. 19).

**2** Press and hold **ENTER**.

The Manual preset display is shown.

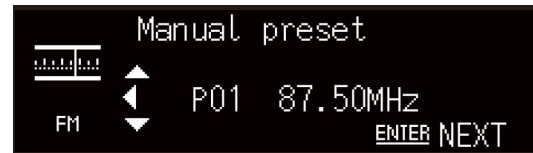

**3** Press **▲/▼** to select the required preset number, and press **ENTER**.

**4** Use **◀/▶** to select **OK**, and press **ENTER**.

### Note

Press **OPTION** to cancel Manual preset.

## Selecting a preset station

**1** Press **RADIO**.

**2** Press **▲/▼** to select a preset station.

## Deleting a preset station

**1** Press **RADIO**.

**2** Press and hold **□**.

The preset deletion display is shown.

**3** Use **▲/▼** to select **Delete ALL** or the preset number to be deleted, and press **ENTER**.

**4** Use **◀/▶** to select **OK**, and press **ENTER**.

**5** Press **OPTION** to exit the settings display.

# Listening to music on USB flash drives

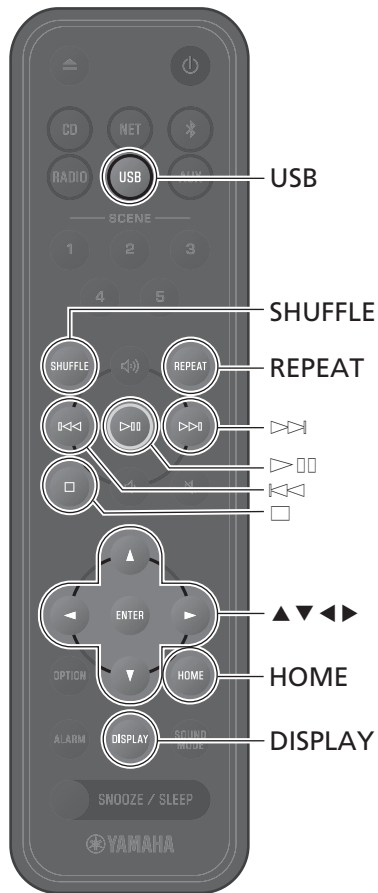

- 1 Press **USB**.
- 2 Connect a USB flash drive to the USB jack.

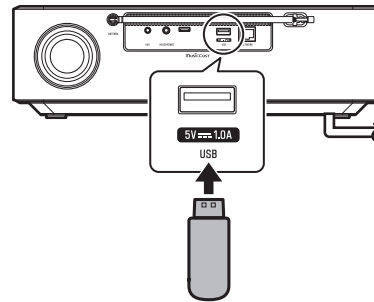

- 3 Browse content and select a song.

▲/▼	Move between options.
ENTER/▶	Finalize the selected option and proceed to the next option, or play the selected song.
HOME	Move to the top of the folder hierarchy.
◀	Move to the previous layer in the folder hierarchy.
DISPLAY	Terminate browsing and display information about content currently playing.

- 4 Play a song.

▶◻◻	Play/pause
◀◻/◻▶	Move to the next or previous song in the folder.
◻	Stop
SHUFFLE	Shuffle playback (☞ p. 28)
REPEAT	Repeat playback (☞ p. 28)

**Note**

- Music files stored on USB flash drives can be played via the unit. See “Devices/media, and file formats supported by the unit” for information on USB flash drives supported by the unit (☞ p. 56).
- The unit can play up to 500 songs. The maximum number of songs the unit can play may decrease depending on the folder structure.
- Some USB flash drives may not work properly even if they meet the requirements. Playability of and power supply to all USB flash drives are not guaranteed.
- Stop playback before disconnecting the USB flash drive.
- Connect a USB flash drive directly to the USB jack of the unit. Do not use extension cables.
- A USB flash drive is automatically charged as long as it is connected to the unit. However, some devices may not charge when connected. See “Charging in standby” in “Option settings” to disable the charge function (☞ p. 39).



**WARNING**

When charging a USB flash drive, follow the instruction manual included with the USB flash drive. Failure to observe this may result in fire, overheating, burst, or malfunction.

# Listening to music from an external device

Music played on an external device connected to the AUX jack on the unit's rear panel can be heard through this unit. See documentation supplied with the external device for more information.

## Note

**Lower the volume sufficiently on the unit and external device before connection.**

Otherwise, the volume may be unexpectedly loud when music begins playing.



- 1** Unplug the power cord from the electrical outlet, and connect the external device to the unit.

Use commercially available cables for connections.

- 2** Plug the power cord into an electrical outlet, and turn on the unit.

- 3** Press **AUX**.

- 4** Play the external device connected to the unit.

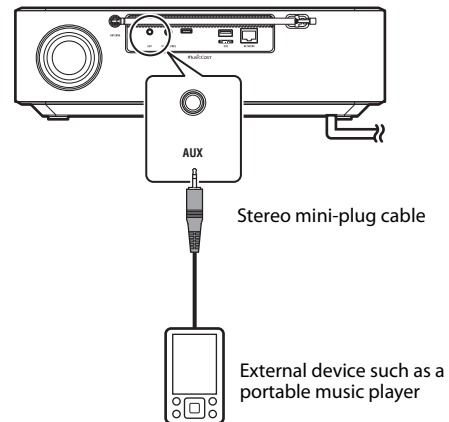

# Listening to music stored on the mobile device

The unit can be used to play music files stored on the mobile device to which the MusicCast Controller app has been installed.

## Note

The types (formats) of audio files that can be played vary by mobile device. See documentation provided with your mobile device for information on the supported file formats.

- 1 Select this unit (the room in which this unit is located) on the MusicCast Controller app screen.
- 2 Select **This phone**.

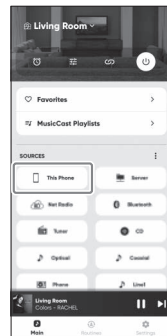

- 3 Select a music file.  
Music begins playing.

# Listening to Internet radio

Use the MusicCast Controller app to listen to Internet radio.

**1** Select this unit (the room in which this unit is located) on the MusicCast Controller app screen.

**2** Select **Net Radio**.

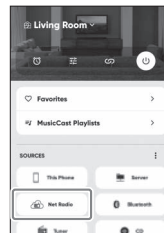

**3** Select a radio station.

The radio broadcast begins playing and information is shown in the unit's display.



## Note

- Internet radio stations can be registered as favorites with the unit using the MusicCast Controller app.
- Some Internet radio stations may not be available, or may be available only during certain hours.
- This function uses airable.Radio's extensive catalog. "airable" is a service of airable GmbH.
- This service may change, be discontinued, or be terminated without notice.

The remote control can also be used to control Internet radio listening.



**1** Press **NET** repeatedly to select **NET RADIO**.

The input source switches between SERVER, NET RADIO, and a streaming service each time the button is pressed.

**2** Select a radio station.

Use **▲/▼/◀/▶** to select a radio station, and press **ENTER** to play.



▲/▼	Move between options.
ENTER/▶	Finalize the selected option and proceed to the next option.
◀	Move to the previous layer in the folder hierarchy.
HOME	Move to the top of the folder hierarchy.
DISPLAY	Display information on audio being played.

**3** Playback begins.

Press **□** to stop playback.



## Listening to streaming services

This unit can be used to listen to content delivered by streaming services. The services available vary depending upon the unit and/or region. You can only listen to services that both have a local service area and are supported by the unit.

Streaming services supported by the unit are displayed in the MusicCast Controller screen. However, you can only listen to those operating locally (you cannot listen to services if you are outside of their service area).

To listen to a streaming service, sign-in to your account for that service from the MusicCast Controller app and start using the service.



A streaming service can also be selected by pressing **NET**. Previously selected content will play.

### **Note**

- Some streaming services require users to apply and pay for an account. For more information, visit the website for the particular service.
- Streaming services may change, be discontinued, or be terminated without notice.

# Listening to music stored on a media server (computer or NAS)

Music files stored on a media server (computer or network attached storage (NAS) device) on the same network as the unit can be played.

**Note**

- Connect the unit and computer (or NAS) to the same wireless LAN router (access point).
- Media sharing must be enabled for all applicable devices and media server software before music files can be played. For more information, see documentation supplied with devices and software for instructions on enabling media sharing.
- For information on music files that can be played using the unit, see "Devices/media, and file formats supported by the unit" (☞ p. 55).

Play a music file using the MusicCast Controller app.

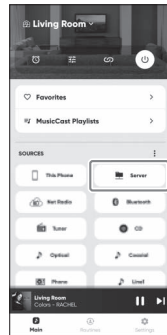

The remote control can be used to control the playback of music files on the media server.

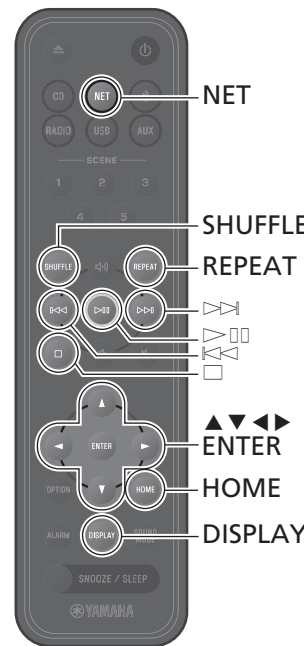

- 1 Press **NET** to select **SERVER**.
- 2 Browse content and select a song.

▲/▼	Move between options.
ENTER/▶	Finalize the selected option and proceed to the next option, or play the selected song.
HOME	Move to the top of the folder hierarchy.
◀	Move to the previous layer in the folder hierarchy.
DISPLAY	Terminate browsing and display information about content currently playing.

- 3 Play a song.

▶◻◻	Play/pause
◀◻/◻▶	Move to the next or previous song in the folder.
◻	Stop
SHUFFLE	Shuffle playback (☞ p. 28)
REPEAT	Repeat playback (☞ p. 28)

# Listening to music via AirPlay 2

Music files in iTunes, or stored on an iPhone, can be played using the AirPlay 2 function.

## Note

- Connect the unit, computer (or NAS), and iPhone to the same wireless LAN router (access point).
- For information on the iPhone supported by the unit, see “Devices/media, and file formats supported by the unit” (p. 55).
- For information on AirPlay, visit the Apple website.

## 1 Start iTunes, or display the iPhone’s music playback screen.

When iTunes, or the iPhone, recognizes the unit, the AirPlay icon will be displayed on the screen.



## Note

If the icon is not displayed, check to see that the unit and the computer (or iPhone) are correctly connected to the wireless LAN router.

## 2 Click or tap the AirPlay icon, and select the unit (the room in which this unit is located) as the audio output destination.

## 3 Play a music file.

The unit’s input source changes to AirPlay, and music will begin playing.

# Other features

Features such as shuffle and repeat playback, display of song information, and a SCENE function make this unit even more convenient and enjoyable to use.

## Shuffle/repeat playback

Press **SHUFFLE** or **REPEAT** during playback.

The indicators will change each time **SHUFFLE** or **REPEAT** is pressed, and songs will play as described below. The range of shuffle playback and repeat playback varies by the input source.

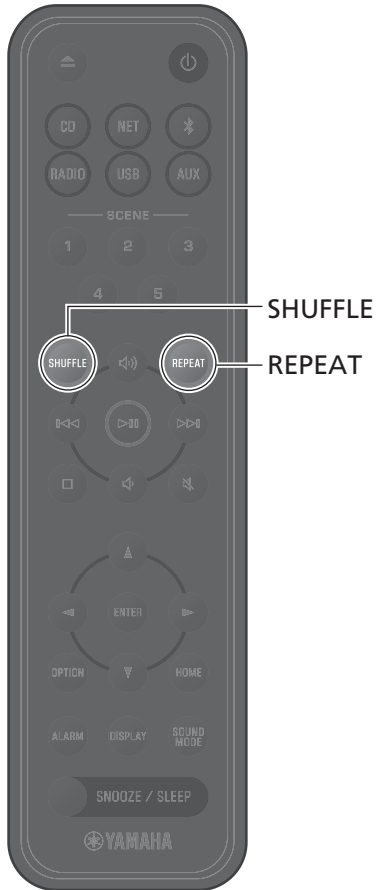

### Shuffle playback

Shuffle indicator	Function
	Shuffle songs.
No indicator	The shuffle function is not applied.

### Repeat playback

Repeat indicators	Function
	Repeat the song being played.
	Repeat songs.
No indicator	The repeat function is not applied.

## Playback information

While content is being played, information such as playing time can be shown in the display.





Press **DISPLAY** during playback.

The display switches each time **DISPLAY** is pressed.

### Note

Press and hold **DISPLAY** while a CD/data CD is playing to switch the time display for the current song to a progress bar or numbers only.



Display	Information
	Song title
	Artist name
	Album title
	Folder name (data CD only)
	File name (data CD only)

### Note

- Information such as the album title may not be properly displayed for songs played from some types of media.
- Song titles and other information are not displayed when a CD that does not support CD-Text is played.

# Adjusting sound quality

Adjust audio parameters as needed to suit individual preferences.

## Equalizer

Adjust the level at which low, middle, and high tones are output.

### Note

Press **OPTION** to cancel setup before it is completed.

- 1 Press **OPTION**.
- 2 Use **◀/▶** to select  and press **ENTER**.
- 3 Use **▲/▼** to select **Equalizer** and press **ENTER**.
- 4 Adjust low, middle, and high tones.

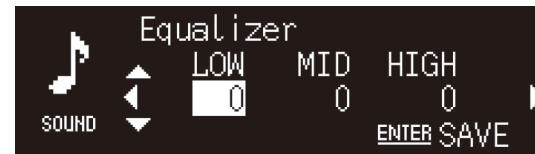

Use **▲/▼** to change the level. Use **◀/▶** to select another tone. Press **ENTER** to save settings.

Default: 0

Adjustable level: -10 to +10

- 5 Press **OPTION** to exit the settings display.

## Selecting the sound mode

Each time **SOUND MODE** is pressed, sound mode is switched between Bass Booster and Standard.

- Bass Booster (default)  
Best for music
- Standard  
Best for human voices (talk radio, etc.)

### Note

Sound mode is not applied when headphones are connected to the unit.



## Registering favorites with SCENE

Favorite songs and radio stations can be assigned to the SCENE (1 to 5) buttons. Once registered, favorites can easily be selected for listening.



### Registering favorites

Press and hold one of the SCENE buttons while the input source to be registered is playing.

The song or radio station that is playing will be assigned to that SCENE button.

#### Note

- The song or radio station currently playing will be assigned to the SCENE button when listening from a CD, USB storage device, or one of certain network services. To play from another input source, press the SCENE button to which that source was assigned.
- The equalizer settings and sound mode applied to the song or radio station are also assigned to that SCENE button.

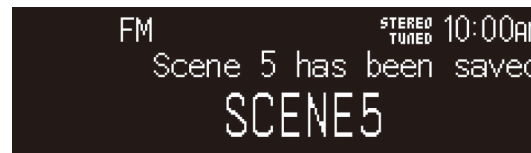

### Listening to favorites

Press the SCENE button to which a favorite song or radio station has been assigned.

The song or radio station assigned to that SCENE button will play. When the SCENE button is pressed in standby mode, the unit will be turned on and playback will begin.

#### Note

- When a favorite is registered with a SCENE button to which another favorite was previously assigned, the new favorite will replace the previous favorite.
- If a song is assigned to a SCENE button, and another medium or device is loaded in, or connected to, the unit, the song assigned to the SCENE button will not play when that SCENE button is pressed.
- If a song on a USB flash drive has been assigned to a SCENE button and a file is added to, or deleted from, the USB flash drive, that song may not play when its SCENE button is pressed. If this occurs, assign the song to the SCENE button again.

# Alarm (IntelliAlarm)

Five alarm options—music, beeps, combination of music and beeps—are available using the MusicCast Controller app. A CD, USB flash drive, radio station, or network content can be selected as the source of music used for the alarm. The alarm can be turned on, the alarm time set, and the alarm turned off using the unit.



## Setting the alarm

### 1 Press **ALARM**.

The alarm setup display in the option settings is shown.

#### **Note**

Press **OPTION** to close the alarm display while setting the alarm.

### 2 Use ▲/▼ to select the alarm number (1 to 5) and press **ENTER**.

### 3 Configure the alarm function.

Use ▲/▼ to change settings and ► to move between the items indicated below. Press **ENTER** to complete setup.

1. Turn the alarm on or off
2. Adjust the hour and minutes

### 4 Press **OPTION** to exit the settings display.

The alarm indicator is displayed.

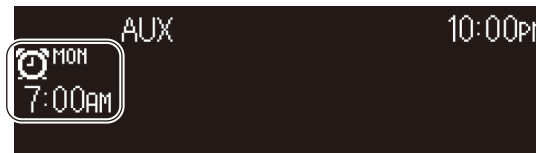

## Turning on and off the alarm

### 1 Press **ALARM**.

The alarm display in the option settings is shown.

### 2 Use ▲/▼ to select the alarm number and press **ENTER**.

### 3 Use ▲/▼ to select **ON** or **OFF** and press **ENTER**.

### 4 Press **OPTION** to exit the settings display.

When the alarm is turned on, the alarm indicator is displayed.





## Stop the alarm

### Stop the alarm temporarily

Press **SNOOZE/SLEEP** while the alarm is sounding to stop the alarm. The alarm stops temporarily and begins sounding again five minutes later (snooze function).

#### Note

When “Music + beeps” is selected as the alarm type, pressing **SNOOZE/SLEEP** while the alarm is sounding will stop only the beeps. Press **SNOOZE/SLEEP** again to stop the music as well. Note that the alarm will sound again five minutes later.

### Stop the alarm completely

Press and hold **SNOOZE/SLEEP** or press **ALARM** once while the alarm is sounding to stop the alarm completely.

#### Note

If the alarm is not stopped manually, it will stop automatically after 60 minutes have passed. The MusicCast Controller app can be used to choose the alarm duration.

## Using the sleep timer

The unit automatically enters standby mode when the specified time has elapsed. The time can be selected from 30, 60, 90, or 120 minutes, or the sleep timer can be disabled (OFF).

### Press **SNOOZE/SLEEP**.

The time selected changes each time **SNOOZE/SLEEP** is pressed. The sleep indicator is displayed when the sleep timer is set.

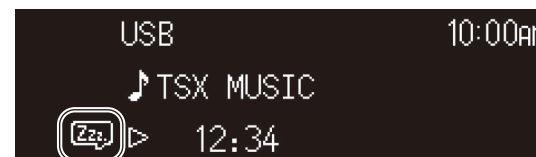

#### Note

To cancel the sleep timer, press **SNOOZE/SLEEP**.

## Child lock function

The child lock function disables operations from the controls on the unit to prevent unintended or accidental operation. This function is disabled by default. When the child lock function is enabled, only the following functions can be operated via the controls on the unit. Use the remote control or MusicCast Controller app to operate other functions.

- turn on the unit/set the unit to standby mode
  - stop the alarm
  - insert a CD
- Take all necessary precautions to prevent children from inserting other objects into the disc slot.

### Enabling/disabling the child lock function

- 1 Press **OPTION**.
- 2 Use **◀/▶** to select  and then press **ENTER**.
- 3 Use **▲/▼** to select **Child lock** and then press **ENTER**.  
Press **OPTION** to cancel setup before it is completed.



- 4 Use **▲/▼** to select **ON** and then press **ENTER**.

- 5 Press **OPTION** to exit the settings display.

The child lock indicator is displayed.

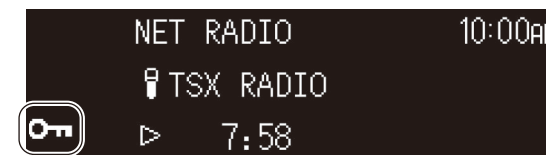

#### Note

To disable the child lock function, select **OFF** in step 4.

## Charging a mobile device (Qi)

A mobile device with the Qi icon can be charged with this unit. For more information regarding the Qi charging function, see documentation provided with your mobile device.

### Note

The Qi charging function is not available in any of the following situations:

- The Qi function is disabled (☞ p. 39).
- The Charging in standby function is disabled (☞ p. 39) and the unit is in standby mode.

Place the mobile device with its Qi icon facing down on the unit's Qi charging pad.

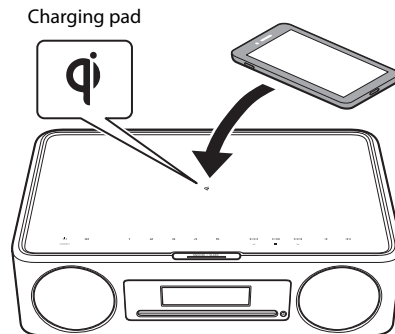

**WARNING**

Do not place metallic objects, such as straps with metal components, near the Qi charging pad. Failure to observe this precaution may result in a fire, burn, or other injury.

Charging status can be confirmed using the Qi charging indicator.

	Charging possible
	Charging in progress
	Charging complete The indicator may not change to the charging complete indicator with some devices, even when they are fully charged.
	Charging failed Be sure that no other objects are positioned near the Qi icon. If you have confirmed that nothing is interfering with Qi function, see "Troubleshooting" for more information (☞ p. 47).

### Note

- If charging does not begin, remove the device and place it on the Qi charging pad again.
- Remove any cover or case attached to the mobile device while charging. If a magnetic card or smart card is positioned between the unit and the mobile device during charging, the magnetic stripe or radio-frequency identification (RFID) chip used on some credit cards or passports may be damaged.
- Charging may take longer at high ambient temperatures.
- If vibrations generated by audio output cause the mobile device to move, position the non-skid pad (supplied) with the rough surface upward between the mobile device and the unit.

## Adjusting display brightness (dimmer)

Display brightness can be adjusted automatically or manually.

<p><b>Automatic (default)</b> The unit automatically selects brightness for bright and dark levels in accordance with ambient lighting. Brightness for both levels can be fine-tuned. Higher values are brighter.</p>	<p>Bright level options 5 to 9 (default: 7)</p> <p>Dark level options 0 to 4 (default: 2)</p>
<p><b>Manual</b> Select the preferred brightness level from 10 options.</p>	<p>0 to 9 (default: 7)</p>



- 1 Press **OPTION**.
- 2 Use **◀/▶** to select , and press **ENTER**.
- 3 Use **▲/▼** to select **Dimmer**, and press **ENTER**.
- 4 Use **▲/▼** to select **Automatic** or **Manual**, and press **ENTER**.

- 5 Use **▲/▼/◀/▶** to select an option and/or level.

The following display is shown when **Automatic** is selected.

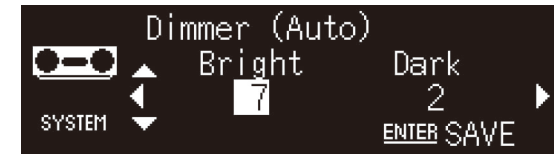

- 6 Press **ENTER** to save settings.
- 7 Press **OPTION** to exit the settings display.

## Option settings

Various settings can be configured using the option menu. See “Option menu list” on the next page for available options.

- 1 Press **OPTION**.

**Note**

The ◊ icon in the display indicates current settings.





- 2 Use ◀/▶ to select a menu group, and press **ENTER**.
- 3 Use ▲/▼/◀/▶ to select a setting, and press **ENTER**.



Press **OPTION** to cancel setup before it is completed.

- 4 Press **OPTION** to exit the settings display.



## Option menu list

Group	Setting		
 CLOCK	Clock setting (☞ p. 10)		
	Alarm list (☞ p. 32)		
 SOUND	Equalizer (☞ p. 30)		
	Sound mode (☞ p. 30)		
 NETWORK	Network information	NW Route & Condition	Display the network route in use and network connection status.
		Wireless (Wi-Fi) SSID	Display the SSID.
		IP Address	Display the IP address.
		Subnet Mask	Display the subnet mask.
		Default Gateway	Display the default gateway.
		Preferred DNS Server	Display the primary DNS server.
		Alternate DNS Server	Display the secondary DNS server.
		MAC Address (Wired)	Display the MAC address.
		MAC Address (Wireless)	Display the MAC address.
		Network Name	Display the network name.
		MusicCast Network	Display information regarding the MusicCast network.
Wireless LAN function	When this function is disabled, the wireless LAN function cannot be used (default: Enable).		
Network route setting	Wired (☞ p. 43)		
	Wireless (Wi-Fi)	WPS (☞ p. 44)	
		Share Wi-Fi (iOS) (☞ p. 45)	
IP address setting	Auto obtain IP address	When this function is disabled, the following settings can be specified manually (default: Enable). <ul style="list-style-type: none"> <li>• IP Address</li> <li>• Subnet Mask</li> <li>• Default Gateway</li> <li>• Preferred DNS Server</li> <li>• Alternate DNS Server</li> </ul>	

Group		Setting
		Child lock (🔗 p. 34)
		Dimmer (🔗 p. 36)
		Language Select a display language.
		Qi function (🔗 p. 35)
		Bluetooth function (🔗 p. 13-15) When this function is disabled, the Bluetooth connection is not available (default: Enable).
 SYSTEM		Auto standby (🔗 p. 9) (default: Enable)
		Charging in standby (🔗 p. 21, 35) When this function is disabled and the unit is in standby mode, the Qi/USB charging function is not available (default: Enable).
	Standby setting	When this function is disabled, the following functions are not available (default: Enable). <ul style="list-style-type: none"> <li>• Turn on the unit using the MusicCast Controller app</li> <li>• Bluetooth connection</li> <li>• Charge a USB flash drive</li> </ul>
		Network standby
		Display in standby When this function is disabled, the display turns off while the unit is in standby mode (default: Enable).
		Manual disc eject Eject the CD.
		Factory setting Restore the unit to factory default settings (reset).
	Firmware information	Version information Display the unit's firmware version.
		USB update (🔗 p. 42)
		Network update (🔗 p. 41)
 FM	<sup>1)</sup> Auto preset (🔗 p. 19)	
	Preset delete (🔗 p. 20)	
 DAB	<sup>2)</sup> Initial scan (🔗 p. 16)	
	Tuning Aid (🔗 p. 18)	
	Preset delete (🔗 p. 17)	

<sup>1)</sup> Displayed only when the input source is FM<sup>2)</sup> Displayed only when the input source is DAB

## Pair the unit with MusicCast-enabled devices

The MusicCast Controller app can be used to pair the unit with other MusicCast-enabled devices to share music between the devices (MusicCast Link). Enjoy listening to music from your smartphone, Internet radio, or streaming services anywhere in your home with simple operation.

Visit the Yamaha website for details regarding MusicCast and MusicCast-enabled devices.

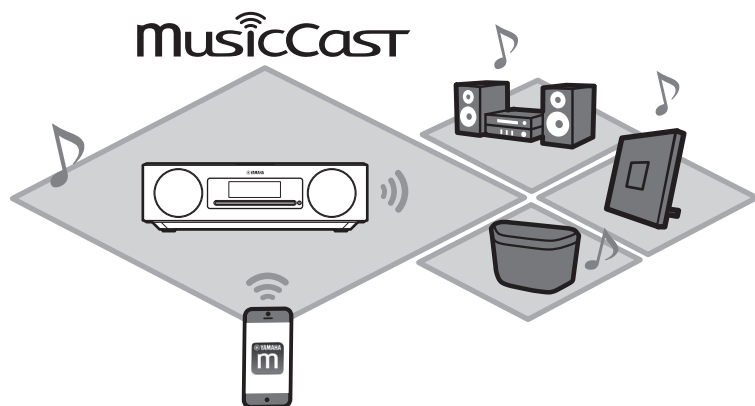

Register the unit with the MusicCast Controller app, and then register other MusicCast-enabled devices with the app.

### **Note**

To register the unit with the app, see “Use MusicCast Controller to connect to a network” (🔍 p. 11).

**1** Tap  (Settings).

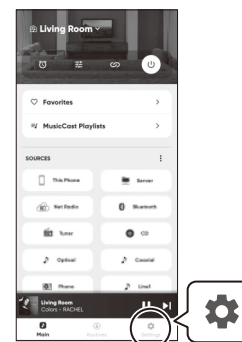

**2** Follow the app’s on-screen instructions to register MusicCast-enabled devices.



# Firmware updates

## Updating the firmware

New firmware will be provided as features are added and issues are resolved. Visit the Yamaha website for details regarding the unit's firmware. The firmware can be updated using the MusicCast Controller app, via the Internet, or using a USB flash drive.

### **Notice**

Do not attempt to operate the unit, or disconnect the power cord or network cable while firmware is being updated. If the firmware update is interrupted, the unit may cease to function. In this case, contact your nearest authorized Yamaha dealer or service center.

## When the unit is connected to the Internet

When new firmware is released, a notice is displayed in the MusicCast Controller app or on the unit.

There firmware can be updated using the app or the unit itself.

- When using the MusicCast Controller app to update the unit's firmware, simply follow the app's on-screen instructions.
- When using the unit itself to update firmware, see "Updating firmware via the unit itself" (☞ p. 42).

### **Note**

Insufficient Internet speed or other wireless network issues may prevent the unit from receiving firmware update notifications. If this occurs, use a USB flash drive to update (☞ p. 42).



### Updating firmware via the unit itself

Follow the procedure described below to update the unit's firmware.

- 1 Press **OPTION**.
- 2 Use ◀/▶ to select , and then press **ENTER**.
- 3 Use ▲/▼ to select **Firmware information**, and press **ENTER**.
- 4 Use ▲/▼ to select **Network update**, and press **ENTER**.
- 5 Use ◀/▶ to select **OK**, and then press **ENTER**.

The NETWORK update dialog is displayed.

The firmware update will begin.

- 6 Press **SNOOZE/SLEEP** on the unit when display alternates between **Completed!** and **Press the SNOOZE key**.

The firmware update has been successfully completed.

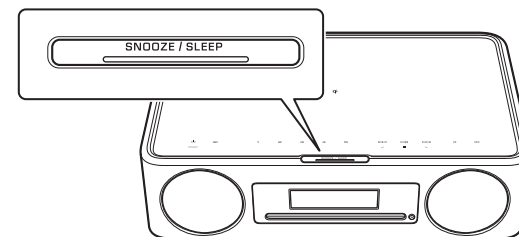

### When the unit is not connected to the Internet

If the unit is not connected to the Internet, or Internet speed is slow, use a USB flash drive to update the firmware. Visit the Yamaha website for information on downloading and updating the firmware.

## Wired network connection

For a wired network connection, connect a standard shielded twisted pair (STP) network cable (straight, category 5 or higher; commercially available) to the NETWORK jack on the rear panel.

**1** Press **OPTION**.

**2** Use **◀/▶** to select  **NETWORK**, and press **ENTER**.

Select **Network route setting>Wired** and follow the instructions in the display to complete setup.

### Note

- When a router that does not support DHCP is used, select  **NETWORK** > **IP address setting** in the option menu to configure network settings (🔧 p. 38).
- To configure your router's subnet mask manually, apply the same subnet mask used by this unit to all devices (🔧 p. 38).



## Using WPS (Wi-Fi Protected Setup) to connect to a network

A wireless LAN router (access point) equipped with a WPS button is required.

- 1 Press **OPTION**.
- 2 Use **◀/▶** to select  and press **ENTER**.

Select **Network route setting>Wireless (Wi-Fi)>WPS** and follow the instructions in the display to complete setup. You must press the WPS button the wireless router during setup.

The  indicator glows when a connection has been established.

### WPS

Wi-Fi Protected Setup (WPS) is a standard established by the Wi-Fi Alliance to allow for easy establishment of a wireless network.

### Note

- WPS cannot be used when a network cable is connected to the unit.
- A wireless connection may not be established if the unit and the wireless LAN router (access point) are too far apart. If you experience difficulty establishing a wireless connection, position the unit and the wireless router (access point) closer to each other.





# Using iPhone settings to connect to a network

When the unit is turned on for the first time after purchase or after initializing the unit, the  indicator on the unit flashes, and the unit will automatically begin searching for an iOS device such as an iPhone. Network settings from your iOS device can be applied to the unit for easy connection to an existing wireless network.

iOS device network settings cannot be automatically applied to the unit (this feature) when a network cable is connected to the unit.

## Note

- Be sure that the iOS device is connected to the wireless LAN router (access point).
- An iOS device running iOS 7.1 or later is required.
- iOS device network settings cannot be applied to the unit to establish a wireless connection if the wireless LAN router uses WEP encryption.
- The following settings will be initialized:
  - Network settings
  - Register the unit with the MusicCast Controller app again ( p. 11).
  - Bluetooth settings
- If any operation is performed while the  indicator flashes, setup will fail. If this occurs, use the remote control to share iOS device network settings.

1 Press **OPTION**.

2 Use /  to select  and press **ENTER**.

Select **Network route setting**>**Wireless (Wi-Fi)**>**Share Wi-Fi (iOS)** and follow the instructions in the display to complete setup.

- 1 While the  indicator is flashing, open the iOS device's Wi-Fi settings, and then specify this unit as the AirPlay speaker.

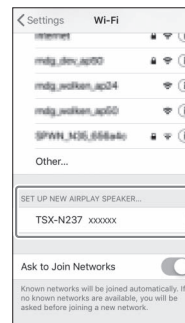

- 2 Choose the wireless network (access point) to which the unit will be connected.

Once network settings have been successfully shared, the unit will automatically connect to the selected wireless network.

# Troubleshooting

Refer to the table below if the unit fails to function properly. If the problem is not listed, or if the symptoms persist after following the instructions provided, turn off the unit, disconnect the unit from the electrical outlet, and contact your nearest authorized Yamaha dealer or service center.

## General

Problem	Cause	Solution
<b>The unit is not on. The touch sensors do not respond.</b>	A touch sensor was tapped or touched inadvertently while the unit was starting up (a period of approx. five seconds after the power cord is plugged into an electrical outlet).	Avoid tapping or inadvertently touching the touch sensors while the unit is starting up. Do not attempt to turn on the unit until start-up is complete.
<b>The unit turns off as soon as it is powered on. The unit does not operate properly.</b>	The power cord is not properly connected.	Connect the power cord firmly.
<b>The unit cannot be operated.</b>	The internal microcomputer has frozen due to an external electrical shock (lightning, excessive static electricity, etc.) or a drop in power supply voltage.	Press and hold ▲ on the unit for at least eight seconds. The unit will be in standby mode.
	An input source has not been properly selected.	Use the input source buttons to select an input source (☞ p. 7).
<b>No sound comes from the unit.</b>	The volume level is set to the minimum level or volume is muted.	Increase the volume.
	The external device is not firmly connected to the AUX jack.	Confirm that the external device is firmly connected to the unit's jack. If there are no problems with connection, check that cables may be damaged.
	Headphones are connected to the unit.	Disconnect the headphones.
	This unit is being affected by strong radio waves due to the usage environment.	It may be improved if the installation location of this unit is changed.
<b>Noise is heard.</b>	The audio cable used to connect the unit and external device may be damaged.	Confirm the audio cable connection. If there are no problems with connection, use another audio cable.
	The sleep timer has been set (☞ p. 33). The Auto standby function is activated. (☞ p. 9).	Turn on the unit and play the source again.
<b>The unit suddenly turns off.</b>	The protection function has been activated.	After confirming that there are no abnormalities, which may include strange noises emitted by the unit or a unit that is unusually warm or hot to the touch, press ▲ on the unit for at least 8 seconds. The unit will enter standby mode.
<b>Breaks, distortion, or unusual noise can be heard.</b>	The volume (especially the bass) is too high.	Decrease the volume, or adjust the bass using Equalizer (☞ p. 30).

Problem	Cause	Solution
<b>The unit's clock is reset.</b>	Power has not been supplied to the unit for more than one week.	If the power cord has been disconnected from the electrical outlet for more than one week, the clock may be reset. Set the clock and alarm again (☞ p. 10).
<b>The clock is not displayed in standby mode.</b>	The Display in standby function is disabled.	Enable the Display in standby function (☞ p. 39)
<b>Interference from nearby electronic equipment is producing noise.</b>	The unit is too close to other electronic equipment.	Position the unit farther away from other electronic equipment.
	The remote control may be outside its operation range.	Operate the remote control within its operation range (☞ p. 9).
<b>The remote control does not work or does not function properly.</b>	The remote control sensor on this unit may be exposed to direct sunlight or strong lighting such as an inverter type fluorescent lamp.	Change the orientation of lighting or the unit, or location of the unit.
	The battery may be worn out.	Replace the battery with a new one (☞ p. 8).
	There are obstacles between the sensor of this unit and the remote control.	Remove the obstacles.
<b>The touch sensors on the unit cannot be operated.</b>	The child lock function is enabled.	Disable the child lock function (☞ p. 34).
	Objects have been placed on the touch sensors.	Do not place objects on the touch sensors.
<b>The display dims.</b>	The display's dimmer function is set to Automatic.	Adjust the display brightness (☞ p. 36).
<b>The display is difficult to see.</b>	The display is too dark.	Adjust display brightness in a dark place (☞ p. 36).
<b>Qi/USB charging is not possible when the unit is in standby mode.</b>	The Charging in standby function is disabled.	Enable the Charging in standby function (☞ p. 39).
	Objects are positioned near the Qi charging pad.	Remove the objects.
<b>Qi charging stops.</b>	The unit will temporarily stop charging when it or the mobile device becomes too hot.	Charging will resume once the temperature of the unit or mobile device has dropped to an acceptable temperature.
	You are attempting to charge a tablet or other device that requires more power than this unit can supply for charging.	These devices cannot be charged using this unit.

# Network

Problem	Cause	Solution
<b>Cannot configure connection using the MusicCast Controller app.</b>	The mobile device is not connected to the wireless LAN router (access point).	Connect the mobile device to the wireless LAN router, and then use MusicCast Controller to configure connection settings.
	The unit is in standby mode.	Turn on the unit.
<b>The MusicCast Controller app does not recognize the unit.</b>	The unit and the mobile device are not on the same network.	Confirm network connections and wireless LAN router settings, and then connect the unit and mobile device to the same network.
	A wireless LAN router that supports multiple SSIDs is used.	The router's network splitter may be blocking access to the unit. When connecting a mobile device, use an SSID that is able to access to the unit. Try connecting to the primary SSID.
<b>The network feature does not function.</b>	Network information (IP address) has not been properly obtained.	Enable the DHCP server function on the router.
	The unit is starting up (a period of approx. 30 seconds after the power cord is plugged into an electrical outlet).	Do not attempt to operate the unit until start-up is complete.
	An IPv6-only router is being used.	Use an IPv4-compatible router.
<b>Files on the media server (computer or NAS) are not displayed (do not play).</b>	The file format is not supported by the unit or the media server.	Be sure to use a file format that is supported by both the unit and the media server. For information on music files supported by this unit, see "Devices/media, and file formats supported by the unit" (🔗 p. 55).
	Media server sharing settings are not correct.	Configure sharing settings to allow the unit access to folders on the media server (🔗 p. 26).
<b>The MusicCast Controller app does not recognize the media server (computer or NAS).</b>	Security software installed on your media server is blocking access by the unit.	Confirm settings for security software installed on the media server or wireless LAN router.
	The unit and the media server are not connected to the same network.	Confirm network connections and wireless LAN router settings, and then connect the unit and media server to the same network.



Problem	Cause	Solution
<b>Unable to play Internet radio.</b>	The selected Internet radio station is currently offline.	The radio station may be experiencing problems with their network, may not be broadcasting, or their services may have been terminated. Try playing the station later or select another station.
	The selected Internet radio station is currently broadcasting silence.	Some Internet radio stations broadcast silence at certain times of the day. When this occurs, there are no problems with reception, but no sound plays. Try playing the station later or select another station.
	Access to the network is restricted by network device (wireless LAN router, etc.) firewall settings.	Check device firewall settings. Internet radio can be played only through the port specified by each radio station. The port number varies depending on the radio station.
<b>Firmware update failed.</b>	The network connection is unstable.	Try again later.
<b>The unit is unable to connect to the Internet via a wireless LAN router (access point).</b>	The wireless LAN router is turned off.	Turn on the wireless LAN router.
	The unit and the wireless LAN router are too far apart.	Place the unit and the wireless LAN router closer to each other.
	There is an obstacle between the unit and the wireless LAN router.	Move the unit and the wireless LAN router to a location with a direct line of sight (no obstacles) between the two.
	The unit's wireless LAN function is disabled.	Enable the unit's wireless LAN function (🔌 p. 38).
<b>The MusicCast Controller app does not detect a wireless network.</b>	A device that operates in the 2.4 GHz band (microwave oven, wireless network device, etc.) is interfering with wireless communication.	Turn off the offending device, or move it farther away from the unit and the wireless LAN router.
	Access to the network is restricted by the wireless LAN router's (access point's) firewall settings.	Confirm wireless LAN router firewall settings.
<b>My iPhone does not recognize the unit when using AirPlay.</b>	A wireless LAN router that supports multiple SSIDs is used.	The router's network splitter may be blocking access to the unit. When connecting a mobile device, use an SSID that is able to access to the unit. Try connecting to the primary SSID.

# Bluetooth

Problem	Cause	Solution
<b>Unable to connect the unit to a Bluetooth device.</b>	The unit is already connected to another Bluetooth device.	Terminate the current Bluetooth connection, and then connect to the new device (☞ p. 13).
	The unit and the Bluetooth device are too far apart.	Move the Bluetooth device closer to the unit.
	A device that operates in the 2.4 GHz-band (microwave oven, wireless network device, etc.) is interfering with wireless communication.	Move the unit and Bluetooth device farther away from the device. If the wireless LAN router supports the 5 GHz-band, connect network devices to the network using the 5 GHz-band.
	The passkey for devices such as a Bluetooth adapter is not "0000".	Use a Bluetooth device with a passkey of "0000."
	The Bluetooth device does not support the Advanced Audio Distribution Profile (A2DP).	Use a Bluetooth device that supports A2DP.
<b>No sound is played, or sound is interrupted during playback.</b>	The volume level on the Bluetooth device is set too low.	Increase the volume on the Bluetooth device.
	The Bluetooth device is not configured to transmit audio signal to this unit.	On the Bluetooth device, select this unit as the audio output destination.
	The Bluetooth connection has been terminated.	Establish the Bluetooth connection again (☞ p. 13).
	A device that operates in the 2.4 GHz band (microwave oven, wireless network device, etc.) is interfering with wireless communication.	Move the unit and Bluetooth device farther away from the device. If the wireless LAN router supports the 5 GHz band, connect network devices to the network using the 5 GHz band.
	The unit and the Bluetooth device are too far apart.	Move the Bluetooth device closer to the unit.

## Disc

Problem	Cause	Solution
<b>Playback does not start after a disc is inserted. Some functions are not available.</b>	The unit does not support the disc inserted.	Use a disc that is supported by the unit (🔗 p. 55).
	The disc may be dirty.	Wipe the disc clean (🔗 p. 55).
<b>Playback does not start (or stops immediately) when ▷/⏏ is pressed.</b>	The unit does not support the disc inserted.	Use a disc that is supported by the unit (🔗 p. 55).
	If the unit was moved from a cold to warm place, condensation may have formed on the disc reading lens.	Wait for an hour or two until the unit adjusts to the room temperature, and try again.
<b>The CD is not ejected when ▲ is pressed.</b>	_____	Use Manual disc eject in the option settings to eject the disc (🔗 p. 39).

## Alarm

Problem	Cause	Solution
<b>The music assigned to the alarm does not play when the alarm sounds.</b>	“BEEP” is selected for the alarm type.	Follow on-screen MusicCast Controller instructions to select “Source” or “Source + BEEP” for the alarm type.
	The selected content is not currently available.	Content reception may fail due to a network error, or the service may have been terminated. Try selecting other content.
	The selected service is broadcasting silence.	Some services broadcast silence at certain times of the day. When this occurs, there are no problems with reception, but no sound plays. Try selecting another service.
	A CD or USB flash drive selected as the source of music is not inserted in or connected to the unit.	Insert the CD in the unit or connect the USB flash drive to the unit.

## USB flash drive

Problem	Cause	Solution
<b>The unit does not detect the USB flash drive.</b>	The USB flash drive is not connected to the USB jack securely.	Turn off the unit, reconnect the USB flash drive, and turn the unit on again (🔧 p. 21).
	A USB flash drive in a format other than FAT16/32 format is used.	Use a USB flash drive with FAT16 or FAT32 format.
<b>Folders and files in the USB flash drive cannot be viewed.</b>	The data in the USB flash drive is protected by encryption.	Use a USB flash drive without an encryption function.
<b>Playback does not begin, or playback stops at the beginning.</b>	The music file is not supported by the unit.	Confirm the file formats that are supported by the unit (🔧 p. 56).

## DAB reception (TSX-N237D only)

Problem	Cause	Solution
<b>Cannot tune in to any DAB stations.</b>	The initial scan operations were not performed.	Perform the initial scan operations (🔧 p. 16).
<b>The initial scan operations are not successful and Not Found is displayed.</b>	DAB signals are too weak.	Use Tuning Aid to check reception strength, adjust the height or direction of the antenna, or move the unit (🔧 p. 18).
	The antenna is not suitably positioned for receiving DAB stations.	
	There is no DAB coverage in your area.	Check with your dealer or WorldDMB online at <a href="http://www.worlddab.org">http://www.worlddab.org</a> for a listing of the DAB coverage in your area.
<b>There is noise interference (e.g. hiss, crackle or jitter).</b>	The antenna is not suitably positioned for receiving DAB stations.	Adjust the height or direction of the antenna.
	DAB signals are too weak.	Use Tuning Aid to check reception strength, adjust the height or direction of the antenna, or move the unit (🔧 p. 18).
<b>The DAB station information is not shown or is inaccurate.</b>	The DAB station may be temporarily out of service, or the DAB station information is not provided by the DAB broadcaster.	Contact the DAB broadcaster.

# FM reception

Problem	Cause	Solution
<b>FM stereo reception is noisy.</b>	The radio station you selected may be far from your area, or the antenna input is poor.	Change the height or direction of the antenna, or change the position of the unit.
<b>Automatic tuning does not work.</b>	The radio station you selected may be far from your area, or the antenna input is poor.	Change the height or direction of the antenna, or change the position of the unit. Tune in to a station manually (☞ p. 19).
<b>Cannot select a preset radio station.</b>	The preset stations may have been erased.	Preset radio stations again (☞ p. 19).
<b>There is distortion, and clear reception cannot be obtained.</b>	Multipath reflection or other radio interference may be occurring. Qi charging is interfering with radio reception.	Change the height or direction of the antenna, or change the position of the unit. Disable the Qi function (☞ p. 39).

# Messages in the display

Input	Message	Description	Solution
<b>General</b>	<b>Please wait</b>	The system is starting up.	
	<b>No disc</b>	The unit is unable to play the inserted disc. The disc may be dirty, or foreign matter may have adhered to it.	Confirm that the disc is supported by the unit (☞ p. 55). Wipe the disc clean, or remove any foreign matter that may have adhered to the disc.
<b>CD</b>	<b>No content</b>	The disc does not contain files that can be played by the unit.	Insert a disc containing files that can be played by the unit (☞ p. 55).
	<b>Read error or Unknown Disc</b>	The unit failed to read the specified file/content.	Eject and reinsert the disc.
		The disc was inserted upside down.	Insert the disc with the labeled side facing up.
<b>USB</b>	<b>No device</b>	The unit is unable to access the USB flash drive.	Turn off the unit, remove the USB flash drive, and then reconnect it to the unit. If the message is displayed a second time, move music files to another USB flash drive, and try playing them again.
		A USB flash drive that is not supported by the unit is connected.	Confirm that the USB flash drive is supported by the unit (☞ p. 56).
	<b>Network is not connected.</b>	The unit is not connected to the network (wired or wireless).	Connect the unit to the network (wired or wireless) (☞ p. 11, 43, 44, 45).
	<b>Not connected</b>	The unit is not connected to a server.	Connect the unit to the server.
	<b>Please sign in</b>	You are not signed in to the streaming service.	Use the MusicCast Controller app to sign in to your account for the particular service (☞ p. 25).
<b>NET</b>	<b>Access Error</b>	The unit is unable to access the USB device.	Turn off the unit, remove the USB flash drive, and then reconnect it to the unit. If the message is displayed a second time, move music files to another USB flash drive, and try playing them again.
		A problem occurs along the network route (path).	Confirm that the wireless LAN router and modem are turned on and the unit is properly connected to the wireless LAN router (or hub).
	<b>Unable to play</b>	The music file cannot be played.	Confirm that the file format is supported by the unit. For information on music files supported by this unit, see the following: "Devices/media, and file formats supported by the unit" (☞ p. 55) If the file is supported by the unit, but still cannot be played, the network may be overloaded.
<b>Bluetooth</b>	<b>Not connected</b>	The Bluetooth device is not connected to the unit.	Check the Bluetooth connection (☞ p. 13).

# Devices/media, and file formats supported by the unit

## Devices/media

### USB flash drives

- This unit is compatible with USB flash drives that are in FAT16 or FAT32 format. Do not connect any other type of USB flash drives.
- USB flash drives with encryption cannot be used.
- Operation of all USB flash drives cannot be guaranteed.

Yamaha and suppliers do not accept any liability for the loss of data saved on a USB flash drive connected to the unit. As a precaution, it is recommended to make backup copies of important files.

### Discs

- This unit is designed for use with audio CD, CD-R/RW (ISO 9660 format) with any of the following logos printed on the disc or the disc jacket.

#### Audio CD



#### CD-R/RW\*



\* Discs which bear one of the following.  
FOR CONSUMER  
FOR CONSUMER USE  
FOR MUSIC USE ONLY

### Notes on discs

- Do not use any other type of disc other than stated above. Doing so may damage the unit.
- CD-R/RW cannot be played back unless finalized. Finalization means the process for making a disc to be ready for playback on a compatible device.
- Some discs cannot be played back depending on the disc characteristics or recording conditions.

- Do not use any non-standard shaped discs such as a heart-shaped disc.
- Do not use discs with many scratches or a crack on their surface, or warped/glued discs.
- Do not touch the surface of the disc. Hold a disc by its edge or center hole.
- Use a soft-tipped pen when writing on the label side of a disc.
- Do not use a disc to which tape, stickers, or labels have been affixed. Discs with any of these inserted into the unit may not be ejected.
- Do not use a protective cover to prevent scratches.
- Do not insert any object other than a disc into the unit.
- Do not insert more than one disc into the unit at one time. This could cause damage to both this unit and the discs.
- If a disc becomes dirty, wipe it with a clean, dry soft cloth from the center out to the edge. Do not use record cleaner or paint thinner.
- Do not use any lens cleaners as they may cause malfunction.
- Do not expose discs to direct sunlight, high temperature, high humidity, or dust.
- When a disc is not being used, remove it from this unit and store in an appropriate case.

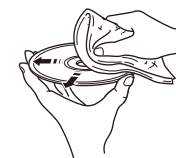

# File format

This unit supports the following file formats.

## USB/Network

Format	Sampling frequency (kHz)	Quantization bits (bit)	Bitrate (kbps)	Number of channels	Support for gapless playback
<b>WAV*</b>	32/44.1/48/ 88.2/96/176.4/ 192	16/24	-	2	✓
<b>MP3</b>	32/44.1/48	-	8 to 320	2	-
<b>WMA</b>	32/44.1/48	-	8 to 320	2	-
<b>MPEG-4 AAC</b>	32/44.1/48	-	8 to 320	2	-
<b>FLAC</b>	32/44.1/48/ 88.2/96/176.4/ 192	16/24	-	2	✓
<b>ALAC</b>	32/44.1/48/ 88.2/96	16/24	-	2	✓
<b>AIFF</b>	32/44.1/48/ 88.2/96/176.4/ 192	16/24	-	2	✓

\* Linear PCM format only

- Digital Rights Management (DRM) files cannot be played back.
- The file formats that can be played on the unit vary depending upon the software installed on the media server (computer or NAS). For more information, see documentation supplied with the software.

## CD

Format	Sampling frequency (kHz)	Quantization bits (bit)	Bitrate (kbps)	Number of channels
<b>MP3</b>	32/44.1/48	16	8-320	2
<b>WMA</b>	32/44.1/48	16	8-320	2



# Specifications

## Input

AUX	3.5 mm stereo mini jack
-----	-------------------------

## Output

HEADPHONES	3.5 mm stereo mini jack
------------	-------------------------

## USB/Network

Audio format	MP3, WMA, AAC, WAV, FLAC, ALAC, AIFF
--------------	--------------------------------------

## CD

Laser	Wave length	775 to 780 nm
	Output power	4 mW
Media*	CD, CD-R/RW	
Audio format	Audio CD, MP3, WMA	

\* An 8-cm mini CD is not available.

## Network

Ethernet interface	100 Base-TX/10 Base-T
Internet radio	airable.radio service supported
AirPlay	AirPlay 2 supported

## Wi-Fi

Wireless LAN standards	IEEE 802.11 a/b/g/n/ac*
Radio frequency	2.4 GHz/5 GHz
Available security method	WEP, WPA2-PSK (AES), Mixed Mode

\* 20 MHz channel bandwidth only

## Tuner

Preset memory	40	
Tuning range	FM	U.S.A. and Canada models: 87.5 MHz to 107.9 MHz Other models: 87.5 MHz to 108.0 MHz

## DAB (Australia, U.K., and Europe models only)

Tuning range	DAB	174 MHz to 240 MHz (Band III)
--------------	-----	-------------------------------

## Bluetooth

Bluetooth version	Ver. 4.2	
Supported profile	A2DP AVRCP	
Compatible codecs	SBC, AAC (sink function only)	
Maximum communication range	10 m (33 ft) (without interference)	
Bluetooth output	Class 2	

## Amplifier section

Maximum output power	Speakers	25 W + 25 W (6 Ω, 1 kHz, 10 % THD)
	Headphones	20 mW + 20 mW (16 to 32 Ω, 1 kHz, 10 % THD)
Driver unit	Woofer: 8 cm cone × 2 Tweeter: 2.5 cm dome × 2	
Frequency response	55 Hz to 20 kHz	

## Wireless Charge

Standard	Qi certified
----------	--------------

**General**

Power supply	Voltage/frequency		U.S.A. and Canada models: AC 120 V, 60 Hz Australia model: AC 100 to 240 V, 50 Hz U.K. and Europe models: AC 230 V, 50 Hz Asia model: AC 220 to 240 V, 50/60 Hz Taiwan model: AC 110 to 120 V, 50/60 Hz China model: AC 220 V, 50 Hz Korea model: AC 220 V, 60 Hz	
Power consumption			42 W	
Standby power consumption* Display in standby: disabled Charging in standby: disabled	Network standby: disabled		0.5 W or below	
	Wireless LAN function: enabled Bluetooth function: disabled	Network route setting	Wired	2.0 W or below
			Wireless (Wi-Fi)	2.0 W or below
	Network standby: enabled Wireless LAN function: disabled Bluetooth function: enabled		2.0 W or below	
Dimensions (W × H × D)			370 × 111 × 260 mm (14-5/8 × 4-3/8 × 10-1/4 inch)	
Weight			4.4 kg (9.7 lbs.)	

\* When the Auto standby function is enabled, the unit will automatically enter standby mode in any of the situations described below. Power consumption in standby mode will vary depending upon the option settings applied to the unit. See the “Standby power consumption” portion of the chart above.  
 (1) CD, Bluetooth, USB, or NET is selected as the input source, but no audio is played and no operations are performed for approximately 20 minutes.  
 (2) An input source other than those noted above is selected, but no operations are performed for approximately 8 hours.

The contents of this manual apply to the latest specifications as of the publishing date. To obtain the latest manual, access the Yamaha website then download the manual file.

# Trademarks



To control this AirPlay 2-enabled speaker, iOS 11.4 or later is required. Use of the Works with Apple badge means that an accessory has been designed to work specifically with the technology identified in the badge and has been certified by the developer to meet Apple performance standards. Apple, AirPlay, Apple TV, Apple Watch, iPad, iPad Air, iPad Pro, iPhone, Lightning, and iTunes are trademarks of Apple Inc., registered in the U.S. and other countries.

## App Store<sup>SM</sup>

App Store is a service mark of Apple Inc.

## Android™, Google Play™

Android and Google Play are trademarks of Google LLC.



The Wi-Fi CERTIFIED™ Logo and Wi-Fi Protected Setup are certification marks of Wi-Fi Alliance®. Wi-Fi, Wi-Fi CERTIFIED, Wi-Fi Protected Setup and WPA2 are registered trademarks of Wi-Fi Alliance®.



The Bluetooth® word mark and logos are registered trademarks owned by Bluetooth SIG, Inc. and any use of such marks by Yamaha Corporation is under license. Other trademarks and trade names are those of their respective owners.



MusicCast is a trademark or registered trademark of Yamaha Corporation.



The 'Qi' symbol is a trademark of the Wireless Power Consortium.



The unit supports DAB/DAB+ tuning. Australia, U.K., and Europe models only

## GPL/LGPL

This product utilizes GPL/LGPL open-source software in some sections. You have the right to obtain, duplicate, modify, and redistribute this open-source code only. For information on GPL/LGPL open source software, how to obtain it, and the GPL/LGPL license, refer to the Yamaha Corporation website (<https://download.yamaha.com/sourcecodes/musiccast/>).

## Licenses

For information on the licenses of the third-party software in this product, refer to the following.

[http://\(IP address of this product\\*\)/licenses.html](http://(IP address of this product*)/licenses.html)

\* IP address of this product is checked with MusicCast Controller.

YAMAHA CORPORATION

10-1 Nakazawa-cho, Naka-ku, Hamamatsu, 430-8650 Japan

Yamaha Global Site  
<https://www.yamaha.com/>

Yamaha Downloads  
<https://download.yamaha.com/>

© 2023 Yamaha Corporation  
Published 09/2023  
KSEM-B0

AV18-0115