



DIGITAL KEYBOARD
PSR-I400

Setting Up

Quick Guide

Reference

Appendix

Owner's Manual



EN

The model number, serial number, power requirements, etc., may be found on or near the name plate, which is at the bottom of the unit. You should note this serial number in the space provided below and retain this manual as a permanent record of your purchase to aid identification in the event of theft.

Model No.

Serial No.

(bottom_en_01)

Table of Contents

Special Features	5
Compatible Format and Functions	8
About the Manuals	9
Included Accessories	9

Setting Up

Panel Controls and Terminals	10
Setting Up	12
Power Requirements	12
Connecting Headphones or External Audio Equipment	13
Connecting a Footswitch to the [SUSTAIN] jack	13
Basic Operations	14
Turning the Power On/Off	14
Auto Power Off Function	14
Selecting Operations	14
Display Items	15

Quick Guide

Try Playing a Variety of Instrument Voices	16
Selecting a Main Voice	16
Resetting the Voice settings to Default (Playing the Harmonium Voice)	16
Playing the Grand Piano Voice	16
Layering a Dual Voice	17
Playing a Split Voice in the Left Hand area	17
Using the Metronome	18
Adding Harmony	19
Creating Arpeggios	20
Triggering the Arpeggio	20
Changing the Arpeggio Type	20
Creating Original Sounds via the LIVE CONTROL Knobs	21
Assigning Functions to the LIVE CONTROL Knobs	21
Applying the Filter to the Main Voice	21
Playing Styles	22
Using the Music Database	22
Playing the Riyaz	23
Playing Songs	24
Listening to a Demo Song	24
Selecting and Playing Back a Song	24
Song Fast Forward, Fast Reverse, and Pause	25
A-B Repeat	25
Turning Each Track On/Off	25
Using the Song Lesson Feature	26
Three Types of Song Lesson	26
Practicing with Song Lesson	26
Making Practice Perfect—Repeat & Learn	27
Recording Your Performance	28
Track Structure of a Song	28
Quick Recording	28
Recording to a Specified Track	29
Clearing a User Song	30
Clearing a Specified Track from a User Song	30
Memorizing Your Favorite Panel Settings	31
Memorizing Panel Settings to the Registration Memory	31
Recalling Panel Settings from the Registration Memory	31
Backup Parameters and Initialization	32
Backup Parameters	32
Initialization	32

Reference

Handy Performance Features	33
Selecting a Reverb Type	33
Selecting a Chorus Type	33
Pitch Controls—Transpose	34
Pitch Controls—Tuning	34
Pitch Controls—the PITCH BEND wheel	34
Calling Up Optimum Panel Settings—One Touch Setting (OTS)	34
Changing the Touch Sensitivity of the Keyboard	35
Selecting an EQ Setting for the Best Sound	35
Voice Settings	36
Selecting a Dual Voice	36
Selecting a Split Voice	36
Voice Editing	36
Parameters Assigned to the LIVE CONTROL Knobs	37
Arpeggio Settings	39
Synchronizing an Arpeggio to Song/Style/Riyaz Playback—Arpeggio Quantize	39
Holding the Arpeggio Playback via the Footswitch	39
Styles (Auto Accompaniment) and Riyaz patterns	40
Style Variations—Sections	40
Synchro Stop	41
Riyaz Variations	42
Changing the Tempo	42
Tap Start	42
Adjusting the Volume of the Style or Riyaz	42
Setting the Split Point	43
Playing Chords Without Style Playback	43
Chord Types for Style Playback	44
Looking Up Chords Using the Chord Dictionary	45
Song Settings	46
BGM (Background Music) Playback	46
Random Song Playback	46
Tempo Setting of the Song	47
Tap Start	47
Song Volume	47
Melody Voice Setting of the Preset Song	47
The Functions	48
Basic Procedure in the Function Display	48
USB Flash Drive Operations	51
Connecting a USB Flash Drive	52
Formatting a USB Flash Drive	53
Saving User Data to a USB Flash Drive	54
Saving a User Song as SMF to a USB Flash Drive	55
Loading User Data from a USB Flash Drive	56
Loading a Style File	57
Deleting a User File in the USB Flash Drive	58
Deleting a SMF File in the USB Flash Drive	58
Exiting from a File Control display	59
Appendix	
Troubleshooting	60
Specifications	61
Index	62

Special Features

Try playing the Riyaz feature!

► Page 23

This special feature lets you play Indian phrase patterns via the Tabla/Mridangam and Tanpura sounds, as if you were using the Tabla machine and Tanpura machine. Let's enjoy the conventional Indian music via the panel buttons and Knobs.



Creating New Sounds via the LIVE CONTROL Knobs

► Page 21

By adjusting just two LIVE CONTROL Knobs you can add varying degrees of distortion, "sweetness," or other characteristics to a sound to change it subtly or drastically. Parameters that can be assigned to the LIVE CONTROL Knobs include effect, filter, envelope generator and more. You can create new sounds in real time!

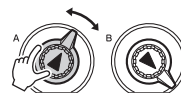

Arpeggio Function

► Page 20

Similar to the arpeggio functions provided on some synthesizers, this function automatically produces arpeggios (broken chords) when you simply play the appropriate notes on the keyboard. A variety of arpeggios can be produced by changing your fingering or the arpeggio type.



Play a Variety of Instrument Voices

► Page 16

The instrument Voice that sounds when you play the keyboard can be changed to violin, flute, harp, or any of an extensive range of Voices. You can change the mood of a song written for piano, for example, by using violin to play it instead. Experience a whole new world of musical variety.



Play Along with Styles

► Page 22

Want to play with full accompaniment? Try the auto-accompaniment Styles. The accompaniment Styles provide the equivalent of a full backing band covering a wide variety of Styles from waltzes to 8-beat to euro-trance ... and much more. Select a Style that matches the music you want to play, or experiment with new Styles to expand your musical horizons.



Play Along with the Raga Scale

► Page 24

Practice Songs for studying the traditional scale of India. Let's enjoy the Raga Scale via the Playing Songs feature.

PRECAUTIONS

PLEASE READ CAREFULLY BEFORE PROCEEDING

Please keep this manual in a safe and handy place for future reference.

For the AC adaptor



WARNING

- This AC adaptor is designed for use with only Yamaha electronic instruments. Do not use for any other purpose.
- Indoor use only. Do not use in any wet environments.



CAUTION

- When setting up, make sure that the AC outlet is easily accessible. If some trouble or malfunction occurs, immediately turn off the power switch of the instrument and disconnect the AC adaptor from the outlet. When the AC adaptor is connected to the AC outlet, keep in mind that electricity is flowing at the minimum level, even if the power switch is turned off. When you are not using the instrument for a long time, make sure to unplug the power cord from the wall AC outlet.

For the instrument



WARNING

Always follow the basic precautions listed below to avoid the possibility of serious injury or even death from electrical shock, short-circuiting, damages, fire or other hazards. These precautions include, but are not limited to, the following:

Power supply/AC adaptor

- Do not place the power cord near heat sources such as heaters or radiators. Also, do not excessively bend or otherwise damage the cord, or place heavy objects on it.
- Only use the voltage specified as correct for the instrument. The required voltage is printed on the name plate of the instrument.
- Use the specified adaptor (page 61) only. Using the wrong adaptor can result in damage to the instrument or overheating.
- Use only the supplied power plug.
- Check the electric plug periodically and remove any dirt or dust which may have accumulated on it.

Do not open

- This instrument contains no user-serviceable parts. Do not open the instrument or attempt to disassemble or modify the internal components in any way. If it should appear to be malfunctioning, discontinue use immediately and have it inspected by qualified Yamaha service personnel.

Water warning

- Do not expose the instrument to rain, use it near water or in damp or wet conditions, or place on it any containers (such as vases, bottles or glasses) containing liquids which might spill into any openings. If any liquid such as water seeps into the instrument, turn off the power immediately and unplug the power cord from the AC outlet. Then have the instrument inspected by qualified Yamaha service personnel.

- Never insert or remove an electric plug with wet hands.

Fire warning

- Do not put burning items, such as candles, on the unit. A burning item may fall over and cause a fire.

Battery

- Follow the precautions below. Failure to do so might result in explosion, fire, overheating or battery fluid leakage.
 - Do not tamper with or disassemble batteries.
 - Do not dispose of batteries in fire.
 - Do not attempt to recharge batteries that are not designed to be charged.
 - Keep the batteries separate from metallic objects such as necklaces, hairpins, coins, and keys.
 - Use the specified battery type (page 12) only.
 - Use new batteries, all of which are the same type, same model, and made by the same manufacturer.
 - Always make sure all batteries are inserted in conformity with the +/- polarity markings.
 - When the batteries run out, or if the instrument is not to be used for a long time, remove the batteries from the instrument.
 - When using Ni-MH batteries, follow the instructions that came with the batteries. Use only the specified charger device when charging.
- Keep batteries away from small children who might accidentally swallow them.

- If the batteries do leak, avoid contact with the leaked fluid. If the battery fluid should come in contact with your eyes, mouth, or skin, wash immediately with water and consult a doctor. Battery fluid is corrosive and may possibly cause loss of sight or chemical burns.

If you notice any abnormality

- When one of the following problems occur, immediately turn off the power switch and disconnect the electric plug from the outlet. (If you

are using batteries, remove all batteries from the instrument.) Then have the device inspected by Yamaha service personnel.

- The power cord or plug becomes frayed or damaged.
- It emits unusual smells or smoke.
- Some object has been dropped into the instrument.
- There is a sudden loss of sound during use of the instrument.
- If any cracks or breakages exist on the instrument.



CAUTION

Always follow the basic precautions listed below to avoid the possibility of physical injury to you or others, or damage to the instrument or other property. These precautions include, but are not limited to, the following:

Power supply/AC adaptor

- Do not connect the instrument to an electrical outlet using a multiple-connector. Doing so can result in lower sound quality, or possibly cause overheating in the outlet.
- When removing the electric plug from the instrument or an outlet, always hold the plug itself and not the cord. Pulling by the cord can damage it.
- Remove the electric plug from the outlet when the instrument is not to be used for extended periods of time, or during electrical storms.

Location

- Do not place the instrument in an unstable position where it might accidentally fall over.
- Before moving the instrument, remove all connected cables, to prevent damage to the cables or injury to anyone who might trip over them.
- When setting up the product, make sure that the AC outlet you are using is easily accessible. If some trouble or malfunction occurs, immediately turn off the power switch and disconnect the plug from the outlet. Even when the power switch is turned off, electricity is still flowing to the product at the minimum level. When you are not using the product for a long time, make sure to unplug the power cord from the wall AC outlet.
- Use only the stand specified for the instrument. When attaching it, use the provided screws only. Failure to do so could cause damage to the internal components or result in the instrument falling over.

Connections

- Before connecting the instrument to other electronic components, turn off the power for all components. Before turning the power on or off for all components, set all volume levels to minimum.
- Be sure to set the volumes of all components at their minimum levels and gradually raise the volume controls while playing the instrument to set the desired listening level.

Handling caution

- Do not insert a finger or hand in any gaps on the instrument.
- Never insert or drop paper, metallic, or other objects into the gaps on the panel or keyboard. This could cause physical injury to you or others, damage to the instrument or other property, or operational failure.
- Do not rest your weight on, or place heavy objects on the instrument, and do not use excessive force on the buttons, switches or connectors.
- Do not use the instrument/device or headphones for a long period of time at a high or uncomfortable volume level, since this can cause permanent hearing loss. If you experience any hearing loss or ringing in the ears, consult a physician.

Yamaha cannot be held responsible for damage caused by improper use or modifications to the instrument, or data that is lost or destroyed.

Always turn the power off when the instrument is not in use.

Even when the [] (Standby/On) switch is in standby status (display is off), electricity is still flowing to the instrument at the minimum level.

When you are not using the instrument for a long time, make sure you unplug the power cord from the wall AC outlet.

Make sure to discard used batteries according to local regulations.

NOTICE

To avoid the possibility of malfunction/ damage to the product, damage to data, or damage to other property, follow the notices below.

■ Handling

- Do not use the instrument in the vicinity of a TV, radio, stereo equipment, mobile phone, or other electric devices. Otherwise, the instrument, TV, or radio may generate noise. When you use the instrument along with an application on your smart device such as a smartphone or tablet, we recommend that you set "Airplane Mode" to on on that device in order to avoid noise caused by communication.
- Do not expose the instrument to excessive dust or vibrations, or extreme cold or heat (such as in direct sunlight, near a heater, or in a car during the day) to prevent the possibility of panel disfiguration, damage to the internal components or unstable operation. (Verified operating temperature range: 5° – 40°C, or 41° – 104°F.)
- Do not place vinyl, plastic or rubber objects on the instrument, since this might discolor the panel or keyboard.

■ Maintenance

- When cleaning the instrument, use a soft cloth. Do not use paint thinners, solvents, alcohol, cleaning fluids, or chemical-impregnated wiping cloths.

■ Saving data

- Some of the data of this instrument (page 32) are retained when the power is turned off. However, the saved data may be lost due to some failure, an operation mistake, etc. Save your important data onto USB flash drive/an external device such as a computer (page 51). Before using a USB flash drive, make sure to refer to page 51.
- To protect against data loss through USB flash drive damage, we recommend that you save your important data onto spare USB flash drive or an external device such as a computer as backup data.

Information**■ About copyrights**

- Copying of the commercially available musical data including but not limited to MIDI data and/or audio data is strictly prohibited except for your personal use.
- This product incorporates and bundles contents in which Yamaha owns copyrights or with respect to which Yamaha has license to use others' copyrights. Due to copyright laws and other relevant laws, you are NOT allowed to distribute media in which these contents are saved or recorded and remain virtually the same or very similar to those in the product.
 - * The contents described above include a computer program, Accompaniment Style data, MIDI data, WAVE data, voice recording data, a score, score data, etc.
 - * You are allowed to distribute medium in which your performance or music production using these contents is recorded, and the permission of Yamaha Corporation is not required in such cases.

■ About functions/data bundled with the instrument

- Some of the preset songs have been edited for length or arrangement, and may not be exactly the same as the original.

■ About this manual

- The illustrations and LCD screens as shown in this manual are for instructional purposes only, and may appear somewhat different from those on your instrument.
- The company names and product names in this manual are the trademarks or registered trademarks of their respective companies.

Compatible Format and Functions

**GM System Level 1**

"GM System Level 1" is an addition to the MIDI standard which ensures that any GM-compatible music data can be accurately played by any GM-compatible tone generator, regardless of manufacturer. The GM mark is affixed to all software and hardware products that support GM System Level.

**XGlite**

As its name implies, "XGlite" is a simplified version of Yamaha's high-quality XG tone generation format. Naturally, you can play back any XG song data using an XGlite tone generator. However, keep in mind that some songs may play back differently compared to the original data, due to the reduced set of control parameters and effects.

**USB**

USB is an abbreviation for Universal Serial Bus. It is a serial interface for connecting a computer with peripheral Devices. It allows "hot swapping" (connecting peripheral devices while the power to the computer is on).

**STYLE FILE**

The Style File Format is Yamaha's original style file format which uses a unique conversion system to provide high-quality automatic accompaniment based on a wide range of chord types.

About the Manuals

This instrument has the following documents and instructional materials.

■ Included Documents



Owner's Manual (this book)

- Setting Up Please read this section first.
- Quick Guide This section explains how to use the basic functions. Refer to this section while playing the instrument.
- Reference This section explains how to make detailed settings for the various functions of the instrument.
- Appendix This section includes troubleshooting information and specifications.

■ Online Materials (from Yamaha Downloads)

The following materials can be obtained from Yamaha Downloads. Enter the model name to search for the desired files on each page.

Yamaha Downloads <https://download.yamaha.com/>

Manual Library



Data List

Contains various important preset content lists such as those of Voices, Styles, Riyaz patterns and Effects.



MIDI Reference

Contains MIDI related information such as MIDI Data Format and the MIDI Implementation Chart.



MIDI Basics (only in English, French, German and Spanish)

Contains basic explanations about MIDI.



Computer-related Operations

Includes instructions on connecting this instrument to a computer, and operations related to transferring Song data.

Documents and Data



Song Book (only English, French, German, Spanish and Japanese)

Contains music scores for the preset Songs (excluding the Demo Songs) including the Songs for practicing the Raga Scale (page 24).

Included Accessories

- Owner's Manual (this book)
- AC Adaptor
- Music Rest
- Online Member Product Registration

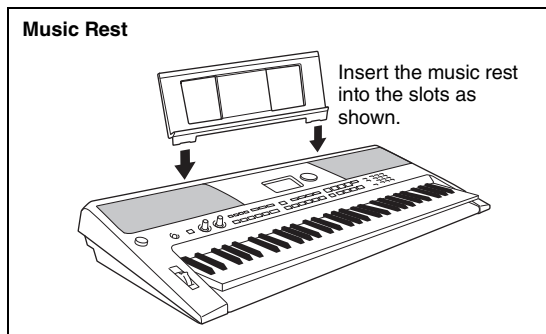

Panel Controls and Terminals

Front Panel

Display (page 15)

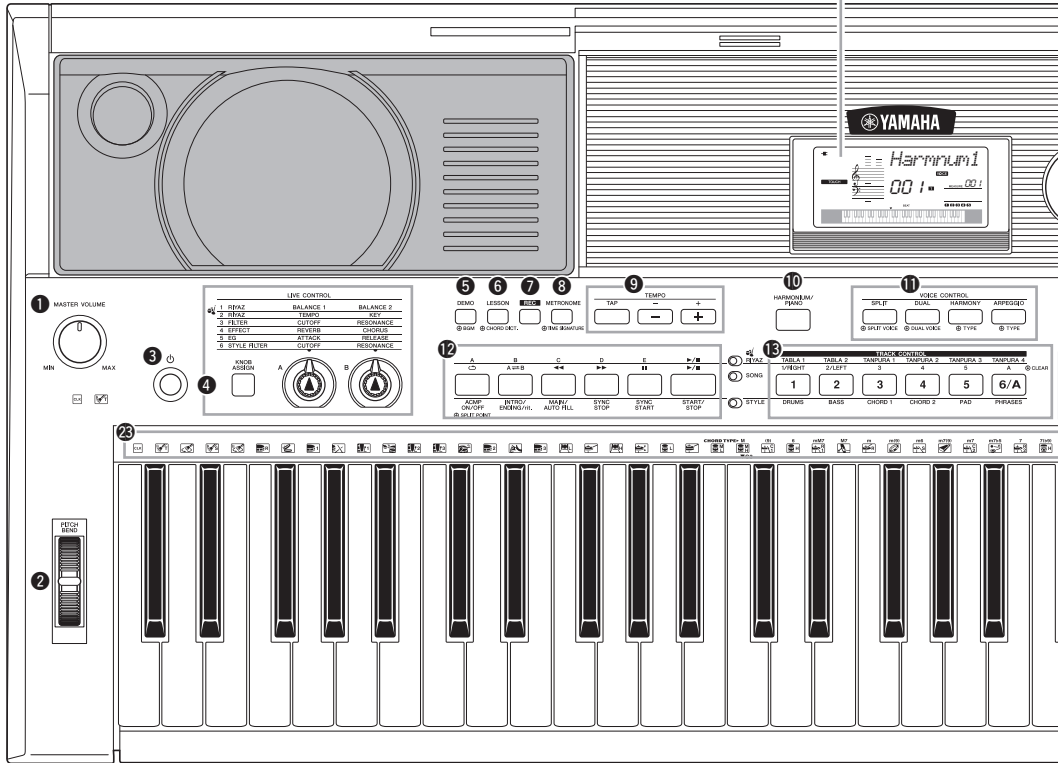

Front Panel

- | | |
|---|---|
| <ul style="list-style-type: none"> ❶ [MASTER VOLUME] control Page 14 ❷ PITCH BEND wheel Page 34 ❸ [⏻] (Standby/On) switch Page 14 ❹ LIVE CONTROL section <ul style="list-style-type: none"> [KNOB ASSIGN] button Page 21 [A] and [B] knobs Page 21 ❺ [DEMO] button Page 24 ❻ [LESSON] button Page 26 ❼ [REC] button Page 28 ❽ [METRONOME] button Page 18 ❾ TEMPO section <ul style="list-style-type: none"> [TAP] button Page 42 [-] and [+] buttons Page 42 ❿ [HARMONIUM/PIANO] button Page 16 | <ul style="list-style-type: none"> ⓫ VOICE CONTROL section <ul style="list-style-type: none"> [SPLIT] button Page 17 [DUAL] button Page 17 [HARMONY] button Page 19 [ARPEGGIO] button Page 20 ⓬ Playback Control buttons <ul style="list-style-type: none"> • When the [RIYAZ] lamp is turned on: <ul style="list-style-type: none"> Pages 23 and 42 • When the [SONG] lamp is turned on: <ul style="list-style-type: none"> Page 25 • When the [STYLE] lamp is turned on: <ul style="list-style-type: none"> Pages 22, 40, and 41 |
|---|---|

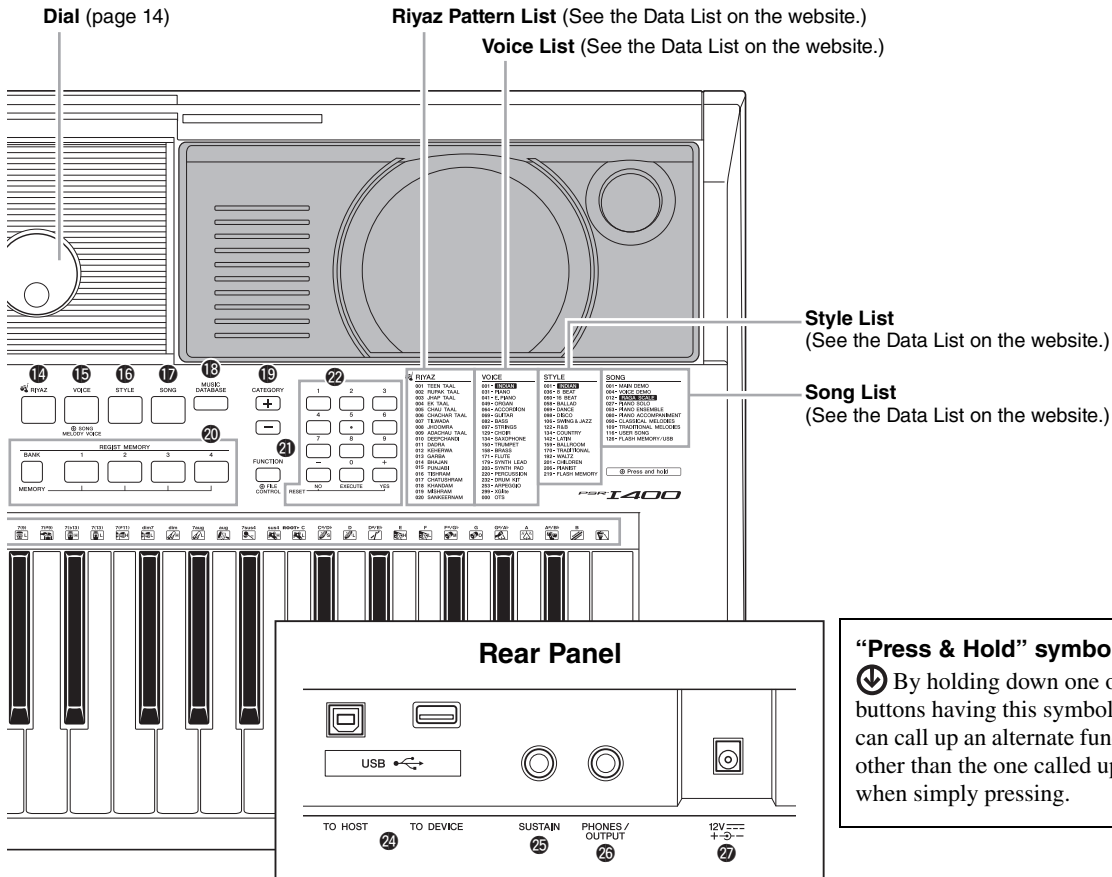

- 13 [TRACK CONTROL] buttons**
 - When the [RIYAZ] lamp is turned on:Page 23
 - When the [SONG] lamp is turned on:Page 25
 - When the [STYLE] lamp is turned on:Page 41
- 14 [RIYAZ] buttonPage 23**
- 15 [VOICE] buttonPage 16**
- 16 [STYLE] buttonPage 22**
- 17 [SONG] buttonPage 24**
- 18 [MUSIC DATABASE] buttonPage 22**
- 19 [CATEGORY] buttonsPage 14**
- 20 [REGIST MEMORY] buttonsPage 31**
- 21 [FUNCTION] buttonPage 48**

- 22 Number buttons [1]–[9], [-/NO], [0/EXECUTE] and [+ /YES] buttonsPage 14**
- 23 Drum illustrations for the Drum Kit....Page 16**
 Each of these indicates the drum or percussion instrument assigned to the corresponding key for “Standard Kit 1.”

Rear Panel

- 24 USB terminals**
 - [USB TO HOST] terminal*
 - [USB TO DEVICE] terminalPage 51
- 25 [SUSTAIN] jackPage 13**
- 26 [PHONES/OUTPUT] jackPage 13**
- 27 DC IN jackPage 12**

* For connecting to a computer. For details, refer to “Computer-related Operations” (page 9). When connecting, use an AB type USB cable of less than 3 meters. USB 3.0 cables cannot be used.

Setting Up

Power Requirements

Although the instrument will run either from an optional AC adaptor or batteries, Yamaha recommends use of an AC adaptor whenever possible. An AC adaptor is more environmentally friendly than batteries and does not deplete resources.

Using an AC Adaptor

Connect the AC adaptor in the order shown in the illustration.

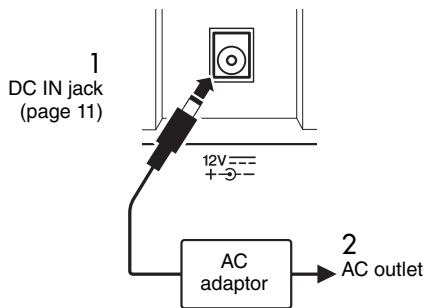

WARNING

• Use the specified AC adaptor (page 61) only. Using the wrong AC adaptor can result in damage to the instrument or overheating.

WARNING

- When using the AC adaptor with a removable plug, make sure to keep the plug attached to the AC adaptor. Using the plug alone can cause electric shock or fire.
- Never touch the metallic section when attaching the plug. To avoid electric shock, short circuit or damage, also be careful that there is no dust between the AC adaptor and plug.

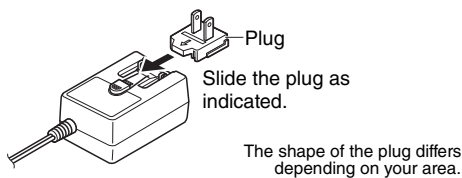

CAUTION

• When setting up the product, make sure that the AC outlet you are using is easily accessible. If some trouble or malfunction occurs, immediately turn the power off and disconnect the plug from the outlet.

NOTE

• Follow this procedure in reverse order when disconnecting the AC adaptor.

Using Batteries

This instrument requires six “AA” size, Alkaline (LR6)/Manganese (R6) batteries, or rechargeable nickel-metal hydride batteries (rechargeable Ni-MH

batteries). The Alkaline batteries or rechargeable Ni-MH batteries are recommended for this instrument, since other types may result in poorer battery performance.

WARNING

• When using Ni-MH batteries, follow the instructions that came with the batteries. Use only the specified charger device when charging.

Installing the batteries

- 1 Make sure that the power of the instrument is off (display is blank, except for notation staff).
- 2 Open the battery compartment cover located on the instrument’s bottom panel.

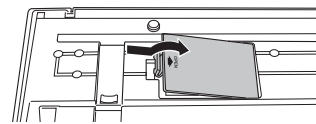

- 3 Insert the six new batteries, being careful to follow the polarity markings on the inside of the compartment.

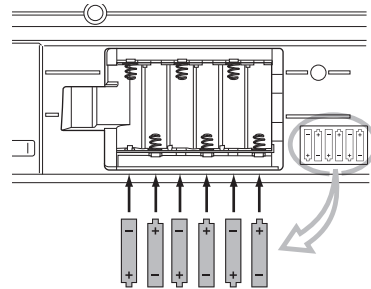

- 4 Replace the compartment cover, making sure that it locks firmly in place.

NOTICE

• Connecting or disconnecting the AC adaptor with batteries installed may turn the power off, resulting in loss of data being recorded or transferred at the time.

When battery power becomes too low for proper operation, the volume may be reduced, the sound may be distorted, and other problems may occur. When this happens, make sure to replace all batteries with new ones or already-recharged ones.

NOTE

- This instrument cannot charge the batteries. Use only the specified charger device when charging.
- Power will be automatically drawn from the AC adaptor if an AC adaptor is connected while batteries are installed in the instrument.

■ Setting the battery type

After installing the new batteries then turning the power on, make sure to set the Battery Type to Rechargeable type or not. For details, refer to page 50.

NOTICE

- Failure to set the Battery Type may shorten the amount of the battery life. Make sure to set the Battery Type correctly.



■ Checking the power status on the display

● Power source on the display

You can confirm the power source at the left corner of the display.



Only one of these is shown.



When  is shown, the power is supplied from the AC adaptor. When  is shown, the power is supplied from the batteries. When the AC adaptor is connected with the batteries installed, the power is supplied from the AC adaptor and the  indication is shown.

● Remaining battery power indication

You can confirm the approximate amount of remaining battery power at the top left of the display.

	Indicates that the power will be turned off immediately. When rechargeable batteries are used, this icon flashes before the power is turned off.
	Indicates that remaining power is insufficient for operation. Before the power runs out, replace all the batteries with new ones, or fully recharged ones (when using rechargeable types). Note that the instrument may not work properly, including unusually soft volume and poor sound quality when remaining power becomes low.
	Indicates that the remaining power is sufficient.

Connecting Headphones or External Audio Equipment

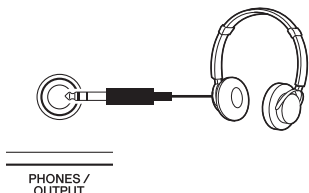

Any pair of stereo headphones with a 1/4" stereo phone plug can be plugged in here for convenient monitoring. The speakers are automatically shut off when a plug is inserted into this jack.

The [PHONES/OUTPUT] jack also functions as an external output. You can connect the [PHONES/OUTPUT] jack to a keyboard amplifier, stereo system, mixer, tape recorder, or other line-level audio device to send the instrument's output signal to that device.

⚠ CAUTION

- Do not use the instrument/device or headphones for a long period of time at a high or uncomfortable volume level, since this can cause permanent hearing loss. If you experience any hearing loss or ringing in the ears, consult a physician.
- Before connecting the instrument to other electronic components, set all volume levels to the minimum, then turn off the power for all components.

NOTICE

- When the instrument's sound is output to an external device, first turn on the power to the instrument, then to the external device. Reverse this order when you turn the power off.

Connecting a Footswitch to the [SUSTAIN] jack

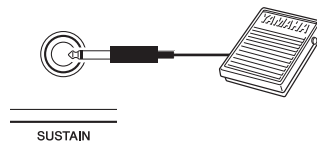



You can produce a natural sustain as you play by pressing an optional footswitch plugged into the [SUSTAIN] jack. Although the footswitch works as the Sustain pedal for most Voices, it features other functions such as Sostenuto and Arpeggio Hold (for Voices 253–298). One of these functions can be assigned to the footswitch on the Function display (page 50).

NOTE

- When Split is on, the sustain function does not affect the current Split Voice (page 17) while sostenuto and Arpeggio Hold (page 39) affect only the current Split Voice.
- Make sure that the footswitch plug is properly connected to the [SUSTAIN] jack before turning on the power.
- Do not press the footswitch while turning the power on. Doing this changes the recognized polarity of the footswitch, resulting in reversed footswitch operation.

Basic Operations

Turning the Power On/Off

Turn down the MASTER VOLUME control to “MIN” then press the [] (Standby/On) switch to turn on the power. While playing the keyboard, adjust the MASTER VOLUME control. To turn off the power, press the [] (Standby/On) switch again for a second.

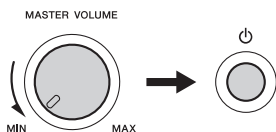

CAUTION

- When using an AC adaptor, even when the power is off, a small amount of electricity is still being consumed by the instrument. When you are not using the instrument for a long time, make sure to unplug the AC adaptor from the wall AC outlet.

Auto Power Off Function

To prevent unnecessary power consumption, this instrument features an Auto Power Off function that automatically turns the power off if the instrument is not operated for a specified period of time. The amount of time that will elapse before the power is automatically turned off is set by default to 30 minutes.

To disable the Auto Power Off function:

Turn off the power, then press the [] (Standby/On) switch to turn on the power while holding down the lowest key.



To set the time that elapses before Auto Power Off is executed:

Press the [FUNCTION] button, press the CATEGORY [+] or [-] button several times until “Auto Power Off” appears then select the desired value.

- Settings: OFF, 5, 10, 15, 30, 60, 120
- Default value: 30

NOTE

- Generally, the data and settings are maintained even when the power is turned off. For details, see page 32.

NOTICE

- Depending on the instrument status, the power may not turn off automatically, even after the elapse of the specified period of time. Always turn off the power manually when the instrument is not in use.

- When the instrument is not operated for a specified period of time while connected to an external device such as an amplifier, speaker or computer, make sure to follow the instructions in the Owner's Manual to turn off the power to the instrument and the connected devices, in order to protect the devices from damage. If you do not want the power to turn off automatically when a device is connected, disable Auto Power Off.

Selecting Operations

Before operating the instrument, it may be helpful to familiarize yourself with the basic controls below that are used to select items and change values.

Dial

Rotate the dial clockwise to increase the value, or counter-clockwise to decrease the value.

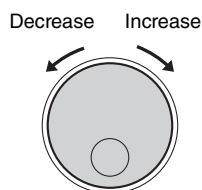

Number buttons

Use the Number buttons to directly enter an item or value. For numbers that start with one or two zeroes, the first zeroes can be omitted.

Example: Selecting Voice 003, Harmnum3.

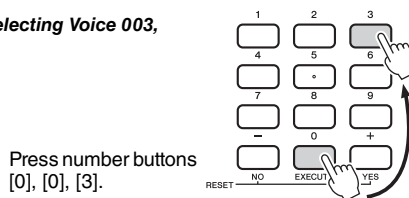

Press number buttons [0], [0], [3].

[-/NO] and [+ /YES] buttons

Press the [+ /YES] button briefly to increase the value by 1, or press the [- /NO] button briefly to decrease the value by 1. Press and hold either button to continuously increase or decrease the value in the corresponding direction.

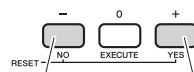

Press briefly to decrease.

Press briefly to increase.

CATEGORY buttons

Use these buttons to jump to the first Voice, Style, or Song in the next or previous Category, and call up the next or previous Function sequentially.



Display Items

The display shows all the current settings of the Song, Style, Riyaz, Voice and other related functions.

Power source status

Indicates the source from which this instrument obtains power, AC adaptor or batteries. (Page 13)



USB connection status

Appears when USB Flash Drive is connected to this instrument. (Page 51)

USB

Notation

Normally this indicates the notes you play. When the Song Lesson function is used, this indicates the current notes and chord of playback. When the Dictionary function is used, this indicates the notes of the chord you specify.



NOTE

- Any notes occurring below or above the staff are indicated by "8va."
- For a few specific chords, not all notes may be shown, due to space limitations in the display.

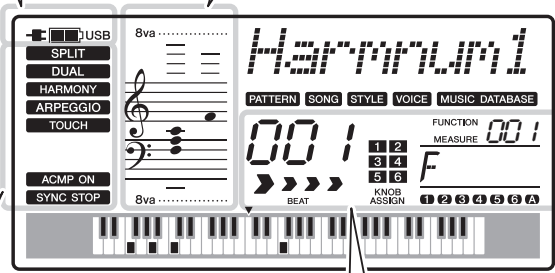

On/off status

This area indicates the on/off status of each function. Each indication is shown when the corresponding function is turned on.

SPLIT	Page 17
DUAL	Page 17
HARMONY	Page 19
ARPEGGIO	Page 20
TOUCH	Page 35
ACMP ON	Page 22
SYNC STOP	Page 41

Beat

Indicates the current beat of playback. (Page 24)



LIVE CONTROL Knob assignment

Indicates the parameters currently assigned to the LIVE CONTROL Knobs. (Page 21)

1	2
3	4
5	6

KNOB ASSIGN

FUNCTION and MEASURE

Indicates the Function number, the current Measure number of a Song/Style, or the current Beat number of the Riyaz pattern.

FUNCTION 001
MEASURE 001

Chord

Indicates the chord which is being played on the keyboard (Page 22) or specified via Song playback.

F

Track status

Indicates the on/off status of the current Song, Style or Riyaz. (Pages 23, 28, 41)

1
2
3
4
5
6
A

Try Playing a Variety of Instrument Voices

In addition to piano, organ, and other “standard” keyboard instruments, this instrument has a large range of Voices that includes guitar, bass, strings, sax, trumpet, drums and percussion, and even sound effects—giving you a wide variety of musical sounds.

Selecting a Main Voice

1 Press the [VOICE] button.

The Voice number and name will be shown.

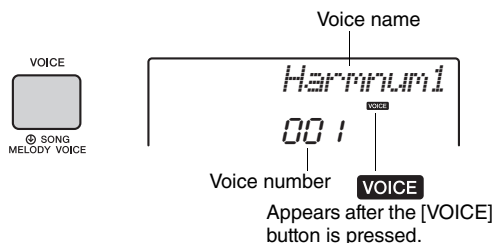

2 Use the dial to select the desired Voice.

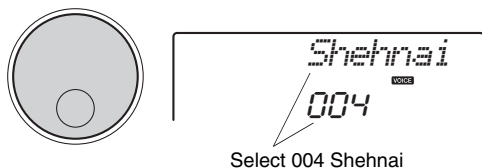

3 Play the keyboard.

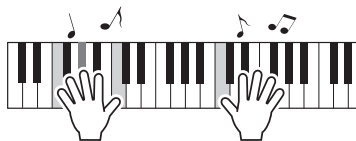

Preset Voice Types

001–030 (Indian Voices)	Used for Indian music performance.
031–231	Instrument Voices.
232–252 (Drum Kit)	Various drum and percussion sounds are assigned to individual keys. For details on assigning instruments to keys, refer to the Drum Kit List in the Data List on the website.
253–298	Used for Arpeggio performance (page 20).
299–764	XGlite Voices.
000	One Touch Setting (OTS) The One Touch Setting feature automatically selects the most suitable Voice when you select a Style, Song or Riyaz. Simply select Voice number “000” to activate this feature.

For the Voice List, see the front panel or the Data List on the website.

Resetting the Voice settings to Default (Playing the Harmonium Voice)

To reset various settings to their default values, press the [HARMONIUM/PIANO] button.

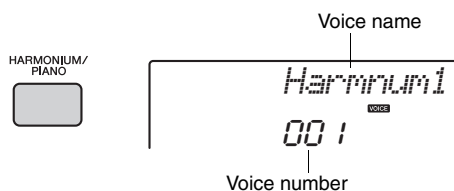

Voice 001 “Harmnum1” will automatically be selected as the Main Voice.

NOTE

- If Voice 001 “Harmnum1” has already been selected, pressing the button selects Voice 031 “Grand Piano.” In this case, press the button once more.

Playing the Grand Piano Voice

To quickly and easily call up a piano sound for simple piano playing, press the [HARMONIUM/PIANO] button, repeatedly if necessary, until Voice 031 “Grand Piano” is shown in the display.

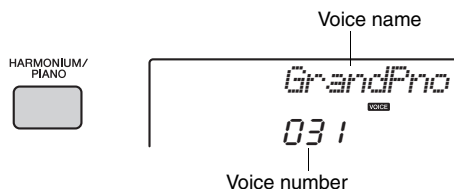

This selects Voice 031 “Grand Piano” as the Main Voice.

Layering a Dual Voice

In addition to the Main Voice, you can layer a different Voice over the entire keyboard as a “Dual Voice.”

1 Press the [DUAL] button to turn Dual on.

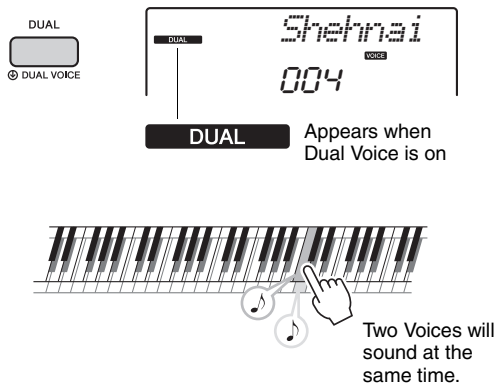

2 Press the [DUAL] button again to exit from Dual.

Although turning on Dual will select a Dual Voice suitable for the current Main Voice, you can easily select a different Dual Voice (page 36).

Playing a Split Voice in the Left Hand area

By dividing the keyboard into the two separate areas, you can play a different Voice between the Left hand and Right hand areas.

1 Press the [SPLIT] button to turn on Split.

The keyboard is divided into the Left hand and Right hand areas.

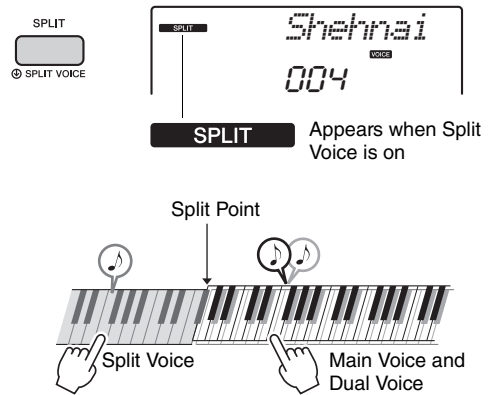

You can play a “Split Voice” on the Left hand area of the keyboard while playing a Main Voice and Dual Voice on the Right hand area of the keyboard.

The highest key for the Left hand area is referred to as the “Split Point” which can be changed from the default F#2 key. For details, refer to page 36.

2 Press the [SPLIT] button again to exit from Split.

You can easily select a different Split Voice (page 36). When you select one of the Voice numbers 283–292 as a Main Voice, Split is turned on automatically and the appropriate Split Voice is called up.

Using the Metronome

The instrument features a built-in metronome (a device that keeps an accurate tempo), convenient for practicing.

- 1 Press the [METRONOME] button to start the metronome.



- 2 Press the [METRONOME] button again to stop the metronome.

Adjusting the Metronome Tempo

Press the TEMPO [TAP] button to call up the Tempo value, then use the TEMPO [-] and [+] buttons to adjust the Tempo value.

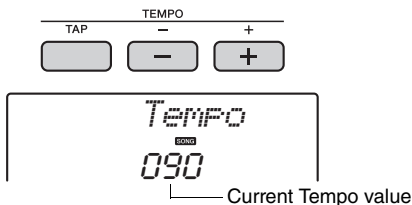

The dial and the Number buttons can also be used to set the Tempo.

Setting the Time Signature

Here, we'll set a time signature of 5/8 as an example.

- 1 Hold down the [METRONOME] button for longer than a second to call up "TimeSigN" (Time Signature Numerator).

The number of beats per measure is shown on the display.

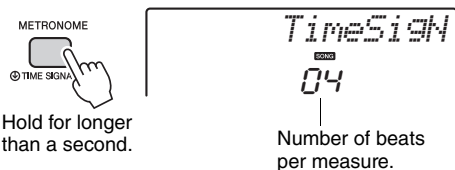

- 2 Rotate the dial to select the number of beats per measure.

A chime will sound on the first beat of each measure while the other beats will click. If "0" is selected, all beats will simply click with no chime. Select 5 for this example.

NOTE

- This parameter cannot be set during playback of a Style, Song or Riyaz.

- 3 Press the CATEGORY [+] button to call up "TimeSigD" (Time Signature Denominator).

The length of one beat is shown on the display.

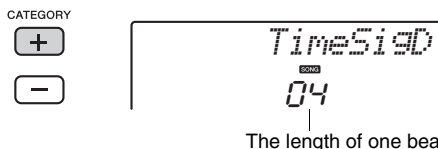

- 4 Rotate the dial to select the length of one beat, from 2nd, 4th, 8th and 16th note.

Select "08" (8th note) for this example.

- 5 Confirm the setting by playing the Metronome.

Setting the Metronome Volume

- 1 Press the [FUNCTION] button.



- 2 Press the CATEGORY [+] or [-] buttons repeatedly until "MtrVol" appears.

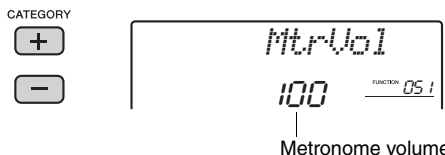

- 3 Rotate the dial to set the Metronome Volume.

Adding Harmony

You can add harmony notes to the Main Voice.

1 Press the [HARMONY] button to turn Harmony on.



Although turning on the Harmony will select a Harmony Type suitable for the current Main Voice, you can select a different Harmony Type.

2 Hold down the [HARMONY] button for longer than a second until “HarmType” appears on the display.

After “HarmType” is shown for a few seconds, the current Harmony Type appears.

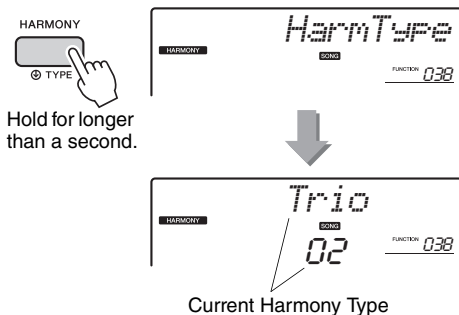

3 Rotate the dial to select the desired Harmony Type.

For details, refer to the Effect Type List in the Data List on the website.

The effect and operation differs depending on the Harmony Type. Refer to the section below.

How to sound each Harmony Type

- Harmony type 01 to 05



Press the right-hand keys while playing chords in the auto accompaniment range of the keyboard when the Auto Accompaniment is on (page 22).

- Harmony type 06 to 12 (Trill)



Hold down two keys.

- Harmony type 13 to 19 (Tremolo)



Keep holding down the keys.

- Harmony type 20 to 26 (Echo)



You can adjust the Harmony Volume in the Function Settings (page 49).

NOTE

- The Harmony function cannot be used in the Riyaz mode. Even if Harmony is turned on, pressing the [RIYAZ] button will turn off the Harmony effect.

Creating Arpeggios

The Arpeggio function lets you create arpeggios (broken chords) by simply pressing the notes of the chord. For example, you could play the notes of a triad—the root, third, and fifth—to trigger interesting phrases. This feature can be used for music production as well as performance.

Triggering the Arpeggio

- 1 Press the [ARPEGGIO] button to turn on the Arpeggio function.



NOTE

- Selecting a Voice number between 253 and 298 will turn on Arpeggio automatically.

- 2 Press a note or notes to trigger Arpeggio.

The Arpeggio phrase differs depending on the number of pressed notes and the area of the keyboard.

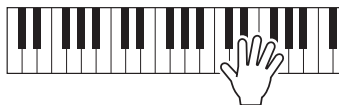

When Split is on, Arpeggio is applied only to the Split Voice. When Split is off, Arpeggio is applied to the Main and Dual Voices. Arpeggio cannot be applied to the Split and Main/Dual Voices simultaneously.

NOTE

- When you select one of the Main Voices 283–292, Split as well as Arpeggio is automatically turned on. This allows you to immediately trigger an Arpeggio by pressing a key to the left of the Split Point after selecting one of these Voices.
- When the Pedal Function is set to “Arp Hold” or “Sus+ArpH” (page 50), pressing the footswitch connected to the [SUSTAIN] jack will cause Arpeggio playback continue even after the note is released.

- 3 To turn off the Arpeggio, press the [ARPEGGIO] button again.

Changing the Arpeggio Type

The most suitable Arpeggio Type is automatically selected when you select a Main Voice, but you can easily select any other Arpeggio Type.

- 1 Hold down the [ARPEGGIO] button for longer than a second.

In the display, “ARP Type” appears for a few seconds, followed by the current Arpeggio Type appears.

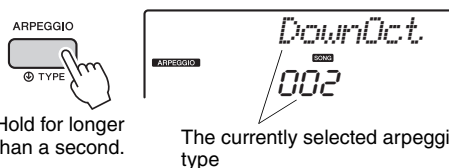

Hold for longer than a second.

The currently selected arpeggio type

- 2 Rotate the dial to select the desired Arpeggio type

For the Arpeggio List, refer to the Data List on the website.

NOTE

- When any of Voices 253–298 are selected, it is a good idea to set the Pedal Function to “Arp Hold” or “Sus+ArpH” (page 50). This setting allows you to use a footswitch (press and hold) to have Arpeggio playback continue even after the note is released.

Creating Original Sounds via the LIVE CONTROL Knobs

The two LIVE CONTROL Knobs located in the lower left area of the panel can be used to add variations to the sound being played, transforming the sound in a variety of musical ways. Select the desired pre-programmed effect combination printed above the LIVE CONTROL Knobs, then rotate the LIVE CONTROL Knobs to enjoy the sound.

Assigning Functions to the LIVE CONTROL Knobs

Repeatedly press the [KNOB ASSIGN] button to sequentially select the six effect combinations provided: (1) → (2) → (3) → (4) → (5) → (6) → (1) ... etc. The current combination number is shown in the display.

LIVE CONTROL		
1 RYAZ	BALANCE 1	BALANCE 2
2 RYAZ	TEMPO	KEY
3 FILTER	CUTOFF	RESONANCE
4 EFFECT	REVERB	CHORUS
5 EG	ATTACK	RELEASE
6 STYLE FILTER	CUTOFF	RESONANCE

Below the table are two knobs labeled A and B, and a square button labeled KNOB ASSIGN.

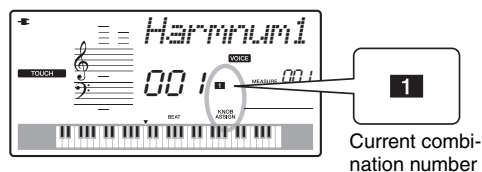

(1)–(2) affect the entire the Riyaz sound, (3)–(5) affect the Main and Dual Voices only, and (6) affects only playback of the Style and Riyaz. For details about each LIVE CONTROL Knob effect, refer to page 37.

Only selecting a function combination will not affect the sound even if the LIVE CONTROL Knob arrow is not at the initial position. After operating the LIVE CONTROL Knob, the selected effect is applied to the sound.

Applying the Filter to the Main Voice

- 1 Select the desired Main Voice.**
Here, select “189 SquareLd” (Square-wave Lead) as a synth-lead type Voice.
- 2 Press the [KNOB ASSIGN] button several times until (3) (Filter) appears in the display).**
- 3 Rotate Knob B all the way to the right (maximum), then play the keyboard with your right hand while operating Knob A with your left.**

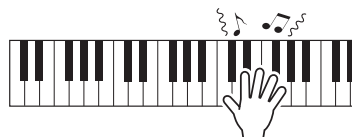
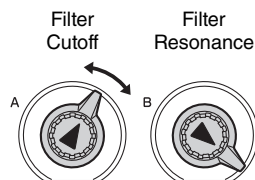

NOTICE

- *Selecting a different Voice will replace the settings created via the LIVE CONTROL Knobs with the default settings of the new Voice. If you create a sound with the LIVE CONTROL Knobs that you wish to keep, make sure to memorize the settings to Registration Memory (page 31) before selecting a different Voice.*

NOTE

- *Rotating a LIVE CONTROL Knob to the right while the volume is set to a high level may result in distortion. If this occurs, reduce the volume level.*

Playing Styles

This instrument includes the Auto Accompaniment feature that plays appropriate “Styles” (rhythm + bass + chord accompaniment). You can select from a huge variety of Styles covering a wide range of musical genres.

1 Press the [STYLE] button, then use the dial to select the desired Style.

For the Style List, see the front panel or the Data List on the website.

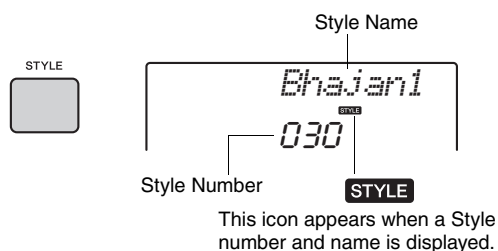

2 Press the [ACMP ON/OFF] button to turn on the Auto Accompaniment.

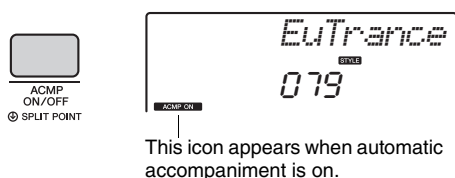

With this operation, the area of the keyboard to the left of the Split Point (54: F#2) becomes the “Auto Accompaniment range” and is used only for specifying the chords.

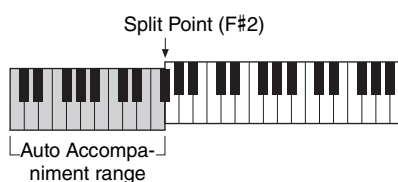

3 Press the [SYNC START] button to turn Synchro Start on.

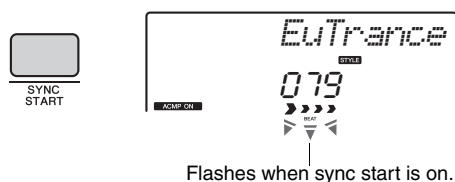

4 Play a chord in the Auto Accompaniment range to start playback.

Play a melody with the right hand and chords with the left hand.

For information about chords, refer to “Chord List” (page 44) or use the Chord Dictionary function (page 45).

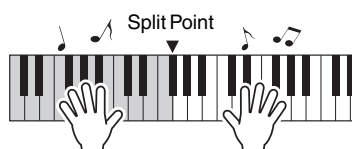

5 Press the [START/STOP] button to stop playback.



You can add intro, ending and rhythm variations to Style playback by using “Sections.” For details, refer to page 40.

Using the Music Database

If you have difficulty finding and selecting the desired Style and Voice, use this feature. From the Music Database, just selecting the favorite music genre calls up the ideal settings.

1 Press the [MUSIC DATABASE] button.

Both the Auto Accompaniment and Synchro Start are automatically turned on.

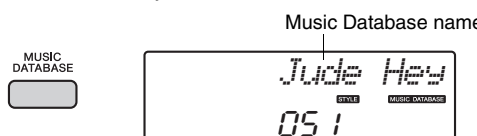

2 Use the dial to select the desired Music Database.

This operation calls up the panel settings such as Voice and Style that are registered to the selected Music Database. For the Music Database List, refer to the Data List on the website.

3 Play the keyboard as described in Steps 4–5 above.

Playing the Riyaz

This instrument provides 20 phrase patterns (consisting of several measures) using the authentic Tabla/Mridangam and Tanpura sounds with looped playback. By using the Riyaz function, try out the conventional Indian music—changing keys and creating dynamic sound variations by rotating the LIVE CONTROL Knobs.

- 1 Press the [RIYAZ] button, then use the dial to select the desired Riyaz pattern. For the Riyaz List, see the front panel or the Data List on the website.



- 2 Press the [START/STOP] button to start looped playback. At first, only the Tabla sound will play back. During playback, enjoy creating sound variations via the following operations.



- Turning on/off Tabla/Mridangam tracks 1 and 2 individually

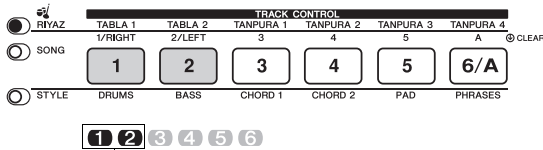

Indicates the on/off status of the Tabla/Mridangam tracks.

TABLA 1 features the lower pitched part while TABLA 2 features the higher pitched part.

- Adding the Tanpura phrase and changing it from 1–4

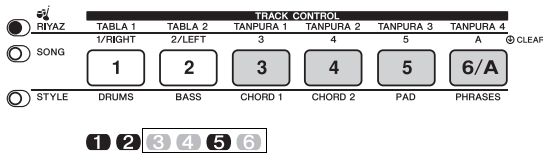

Indicates the current Tanpura number.

At first, press any of the [TANPURA 1]–[TANPURA 4] buttons to add the Tanpura phrase. Next, press another Tanpura button to change the phrase. You can enjoy four phrase variations, which are shared among all Riyaz pat-

terns. To turn off the Tanpura sound, press the Tanpura button of the current number.

- Changing the Variation via the [A]–[E] buttons

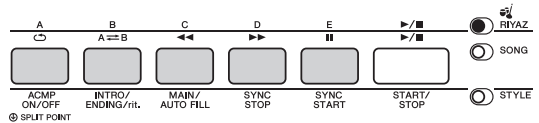

- Using the LIVE CONTROL Knobs

LIVE CONTROL		
1 RIYAZ	BALANCE 1	BALANCE 2
2 RIYAZ	TEMPO	KEY
3 FILTER	CUTOFF	RESONANCE
4 EFFECT	REVERB	CHORUS
5 EG	ATTACK	RELEASE
6 STYLE FILTER	CUTOFF	RESONANCE



Adjusting the Volume Balance
Press the [KNOB ASSIGN] button several times to select “1,” then rotate Knob A to adjust the volume balance between the sounds of Tabla/Mridangam 1 (low-pitched part) and Tabla/Mridangam 2 (high-pitched part), or rotate Knob B to adjust the volume balance between the sounds of the Tabla/Mridangam and Tanpura.

Adjusting the Tempo / Transposing playback
Press the [KNOB ASSIGN] button several times to select “2,” then rotate Knob A to adjust the playback tempo, or rotate Knob B to transpose the playback key in semitones.

NOTE 1

- You can confirm the current key and tempo value on the display. To call up the current tempo value, press the TEMPO [-] or [+] button.

- 3 Press the [START/STOP] button to stop playback.



NOTE 1

- The Riyaz performance cannot be recorded.

Playing Songs

You can simply enjoy listening to the internal Songs, or use them with just about any of the functions, such as Lesson.

● Song Category

The Songs are organized by category as listed below.

In the Song Book on the website (page 9), music scores for the preset Songs (excluding the Demo Songs) are provided.

SONG

- 001 - MAIN DEMO ————— • Gives you an idea of the advanced capabilities of this instrument.
- 004 - VOICE DEMO ————— • Demonstrates many useful Voices of this instrument.
- 012 - **RAGA SCALE** ————— • Practice Songs for studying the traditional scale of India.
- 027 - PIANO SOLO ————— • These piano solo pieces are ideally suited for the Song Lesson.
- 053 - PIANO ENSEMBLE ————— • These piano ensemble pieces are also well suited for the Song Lesson.
- 080 - PIANO ACCOMPANIMENT ——— • When you need to practice backing (accompaniment) patterns, these Songs are ideal for that purpose.
- 090 - CLASSICAL MELODIES ——— • Includes famous classical music pieces.
- 109 - TRADITIONAL MELODIES ——— • Includes traditional Songs from around the world.
- 116 - USER SONG ————— • Songs you record yourself.
- 126 - FLASH MEMORY/USB ————— • Songs transferred from a computer (refer to “Computer-related operations”—page 9) and Songs in the USB Flash Drive (page 53).

Listening to a Demo Song

Press the [DEMO] button to play Songs in sequence. Playback will repeat continuously, starting again from the first Song (001).



To skip to the next Song, press the [+ / YES] button. To skip to the previous Song, press the [- / NO] button. To stop playback, press the [DEMO] button.

By holding down the [DEMO] button for longer than a second, you can change the repeat playback group to playback other songs (page 46).

Selecting and Playing Back a Song

1 Press the [SONG] button, then use the dial to select the desired Song.

For the Song List, see the front panel or the Data List on the website.

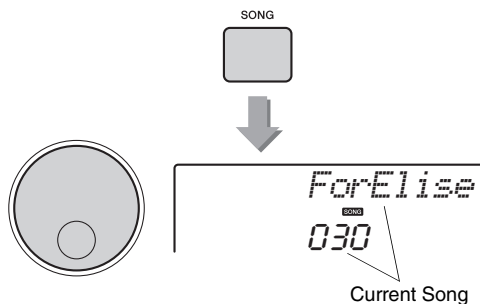

2 Press the [▶/■] (START/STOP) button to start playback.

To skip to the next Song, press the [+ / YES] button. To skip to the previous Song, press the [- / NO] button. To stop playback, press the [▶/■] (START/STOP) button again.

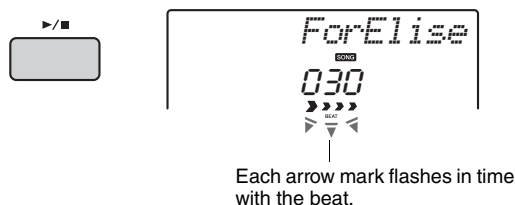

Song Fast Forward, Fast Reverse, and Pause

Like the transport controls on an audio player, this instrument lets you fast forward [▶▶] (Fast Forward), rewind [◀◀] (Fast Reverse) and pause [⏸] (PAUSE) playback of the Song.

Fast Forward

During playback, press this button to rapidly skip ahead to a later point in the Song.

C D E

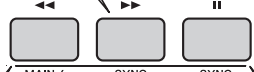

Fast Reverse

During playback, press this button to rapidly return to an earlier point in the Song.

Pause

During playback, press this button to pause playback, and press again to start from that point.

NOTE

• When the A-B repeat is specified, the Fast Reverse and Fast Forward will only work within the range between A and B.

A-B Repeat

You can play back only a specific section of a Song repeatedly by setting the A point (start point) and B point (end point) in one-measure increments.



- 1 Start playback of the Song (page 24).
- 2 When playback reaches to the point you want to specify as the start point, press the [A⇌B] (A-B Repeat) button to set the A point.



- 3 When playback reaches to the point you want to specify as the end point, press the [A⇌B] (A-B Repeat) button again to set the B point.

The specified A-B section of the Song will now play repeatedly.

- 4 To cancel repeat playback, press the [A⇌B] (A-B Repeat) button.

To stop playback, press the [START/STOP] button.

NOTE

• If you want to set the start point “A” at the top of the Song, press the [A⇌B] (A-B Repeat) button before starting playback.

Turning Each Track On/Off

Each “track” of a Song plays a different part—melody, percussion, accompaniment, etc. Each of the tracks can be muted so that you can play the muted part yourself.

Pressing the desired Track button repeatedly will toggle the on/off status.

TRACK CONTROL					
TABLA 1	TABLA 2	TANPURA 1	TANPURA 2	TANPURA 3	TANPURA 4
1/RIGHT	2/LEFT	3	4	5	A
1	2	3	4	5	6/A

Track number on—Track will playback



Track number off—Track is muted or contains no data

NOTE

• Up to two Track buttons can be pressed simultaneously for turning on or off.

Using the Song Lesson Feature

You can use the selected Song for a left-hand, right-hand, or both-hands lesson. Try practicing with these three Song Lesson types while referring to the music scores in the Song Book (page 9).

Three Types of Song Lesson

Lesson 1—Listen

In this Lesson, you need not play the keyboard. The model melody/chords of the part you selected will sound. Listen to it carefully and remember it well.

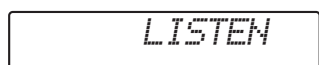

Lesson 2—Timing

In this mode, simply concentrate on playing the notes with the correct timing. Even if you play wrong notes, the correct notes shown in the display will sound



Lesson 3—Waiting

In this Lesson, try playing the correct notes shown on the display. The Song pauses until you play the right note, and playback tempo will change to match the speed at which you are playing at.

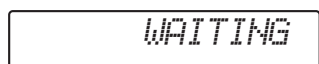

NOTE

- If you want to keep a steady playback tempo is maintained during Lesson 3: Waiting, set the Your Tempo parameter (page 50) to OFF.

Practicing with Song Lesson

1 Select the desired Song for your lesson (page 24).

NOTE

- The Song Lesson can be applied also to the Songs (SMF format 0 only) transferred from a computer (page 24), but cannot be applied to the User Songs.

2 Turn off the part you want to practice.

For the right-hand lesson, press the [1/RIGHT] button to turn off the right-hand part. For the left-hand lesson, press the [2/LEFT] button to turn off the left-hand part. For the lesson using both hands, turn off both the parts.

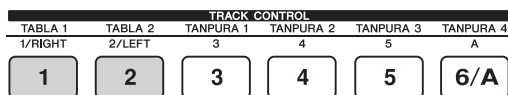

Pressing the [1/RIGHT] and [2/LEFT] buttons repeatedly will toggle the on/off status of each part, which can be shown on the display.

NOTE

- Song numbers 075–100 only support the right-hand lesson.

3 Press the [LESSON] button to start playback of the Song Lesson.

After starting playback, pressing the [LESSON] button repeatedly will change the Lesson number from 1: LISTEN → 2: TIMING → 3: WAITING → off → 1.... Press this button until the desired number is shown on the display.

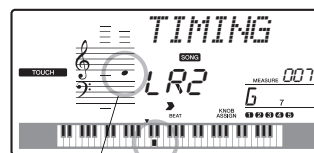

The notation and key positions you should play are shown.

To stop Lesson playback, press the [START/STOP] button.

Even during playback, you can change the Lesson number by pressing the [LESSON] button.

4 When Lesson playback reaches to the end, check your evaluation Grade on the display.

“2 Timing” and “3 Waiting” will evaluate your performance in four levels: OK, Good, Very Good, or Excellent.

See How You’ve Done

Excellent ██████████
 Very Good ████████
 Good ██████
 OK ████

When the lesson Song has played all the way through your performance will be evaluated in 4 levels: OK, Good, Very Good, or Excellent. “Excellent” is the highest evaluation.

After the evaluation display has appeared, the lesson will start again from the beginning.

Making Practice Perfect—Repeat & Learn

If you want to practice a specific section in which you made a mistake or you have difficulty with use the Repeat & Learn function.

Press the [] (Repeat & Learn) button during a Lesson playback.



The Song location will move back four measures, a one-measure count will play, then Song playback will start again. Playback of the four measures will repeat with a one-measure count-in.

To exit from this status, press this button again.

NOTE

- You can change the amount of measures the Repeat & Learn function jumps back by pressing a number button [1]–[9] during repeat playback.

Recording Your Performance

You can record up to 10 of your performances as User Songs. The recorded User Songs can be played back on the instrument.

NOTE

- The Riyaz performance cannot be recorded.

Track Structure of a Song

● Melody Tracks [1]–[5]

The melody performance in the right-hand area of the keyboard will be recorded.

● Accompaniment Track [A]

The chord progression (for the Style) will be recorded.

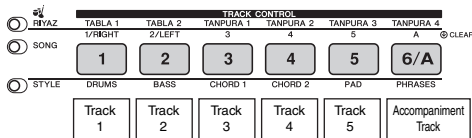

4 Start recording.

- When you press the [SONG] button in Step 2, play any note to start recording.
- When you select a Style in Step 2, play a chord in the Auto Accompaniment area to start recording with Style playback, or press the [START/STOP] button to start recording only with playback of the Rhythm part of a Style.



Current measure number

The current measure will be shown on the display while recording.

5 Press the [START/STOP] or [REC] button to stop recording.

When using a Style, you can stop recording also by pressing the [ENDING] button then waiting until playback ends.



After recording finishes, “Writing!” appears indicating that the recorded data will be stored, then the recorded track numbers in the display will light.

NOTICE

- Never attempt to turn the power off when “Writing!” is shown in the display. Doing so can damage the flash memory and result in a loss of data.

6 To play back the recorded Song, press the [START/STOP] button.

Quick Recording

The operation is useful when you record a new Song from scratch.

- 1 Make the desired settings including the Main Voice selection.**
- 2 Make the desired settings of your performance.**
 - If you want to record only the melody performance, press the [SONG] button.
 - If you want to record the performance using a Style, press the [STYLE] button.
- 3 Press the [REC] button to enter the Record Ready mode.**

If a User Song was not selected beforehand, this operation selects the lowest-numbered unrecorded User Song (from 116–125) as Recording target.

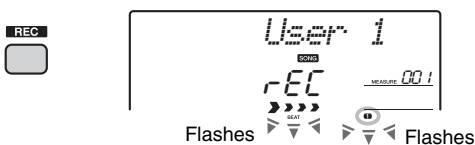

To exit from this status, press the [REC] button again.

NOTE

- The ACMP on/off status cannot be changed after the [REC] button is pressed.

Recording to a Specified Track

The operation here is useful especially when you want to record the additional performances to an already recorded Song.

- 1 Press the [SONG] button, then select the desired User Song (116–125) as the recording target.

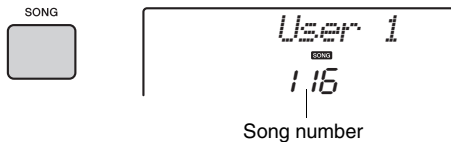

- 2 While holding down the [REC] button, press the desired Track button to enter the Record Ready mode.

- If you want to record only the melody:
While holding down the [REC] button, press one of the [1]–[5] buttons.

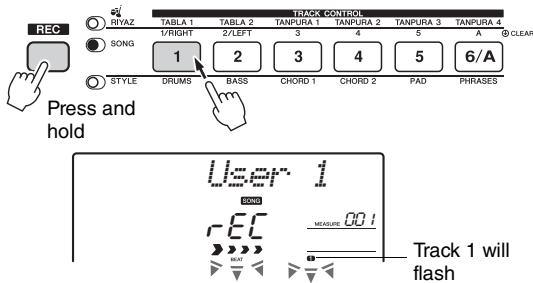

- If you want to record only the Style playback:

Press the [STYLE] button, select the desired Style, then simultaneously hold down the [REC] button and press the [6/A] button. ACMP is automatically turned on.

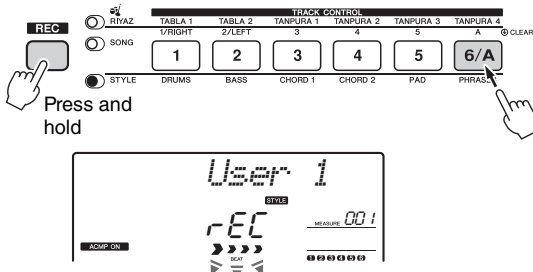

- 3 Same as in Steps 4 to 6 (page 28) in “Quick Recording.”

NOTE

- If the memory becomes full while recording, an alert message will appear and recording will stop automatically. In this case, delete unnecessary data by using the Clear functions (page 30), then execute the recording again.

Limitations while recording

- The on/off status of ACMP cannot be changed.
- The Style number cannot be changed.
- When you use a Style, the following parameters cannot be changed: Reverb Type, Chorus Type, Time Signature, Style number and Style Volume.
- Performance with a Split Voice cannot be recorded.

Clearing a User Song

You can clear all tracks of a User Song.

- 1 Press the [SONG] button, then select the User Song (111–120) to be cleared.
- 2 While holding down the track [A] button, press the track [1] button for longer than a second.

A confirmation message will appear on the display.

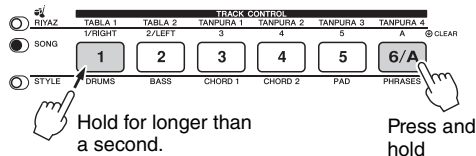

- 3 Press the [+ / YES] button.
A confirmation message will appear on the display. To cancel this operation, press the [- / NO] button.
- 4 Press the [+ / YES] button to clear the Song.
A clear-in-progress message will appear briefly on the display.

Clearing a Specified Track from a User Song

This lets you clear individual tracks from a User Song.

- 1 Press the [SONG] button, then select the desired User Song (116–125).
- 2 From [1]–[5] and [A], press the Track button to be cleared for longer than a second.

A confirmation message will appear on the display.

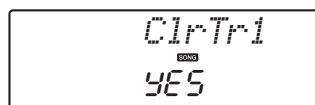
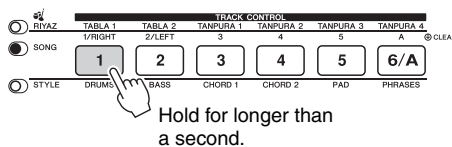

- 3 Press the [+ / YES] button.
A confirmation message will appear on the display. To cancel this operation, press the [- / NO] button.
- 4 Press the [+ / YES] button to clear the track.
A clear-in-progress message will appear briefly on the display.

Memorizing Your Favorite Panel Settings

This instrument has a Registration Memory feature that lets you memorize your favorite settings for easy recall whenever they're needed. Up to 32 complete setups can be saved (eight banks of four setups each).

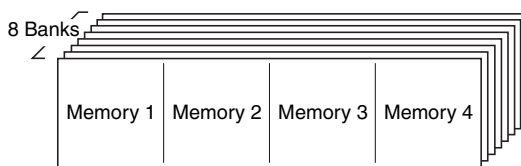

Up to 32 presets (eight banks of four each) can be memorized.

Memorizing Panel Settings to the Registration Memory

- 1 Make the desired settings such as those for Voice, Style, and Riyaz.

NOTE

- Data cannot be saved to the Registration Memory during Song playback.

- 2 Press and release the [BANK/MEMORY] button to call up a Bank number on the display.

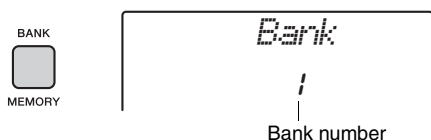

- 3 Press the [BANK/MEMORY] button repeatedly to select a Bank number. You can also select a Bank number by using the dial or the [1]–[8] number buttons.
- 4 While holding down the [BANK/MEMORY] button, press one of the [1]–[4] buttons to memorize the current panel settings.

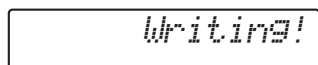
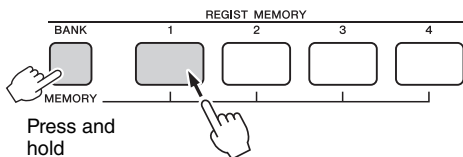

NOTICE

- If you select a Registration Memory number that already contains data, the previous data is deleted and overwritten by the new data.
- Do not turn off the power while memorizing settings to the Registration Memory, otherwise the data may be damaged or lost.

Recalling Panel Settings from the Registration Memory

- 1 Press and release the [BANK/MEMORY] button to call up a Bank number on the display.
- 2 Use the dial or the [1]–[8] number buttons to select a Bank number.
- 3 Press one of the [1]–[4] buttons to call up the panel settings you memorized. The recalled REGIST MEMORY number appears in the display for a few seconds.

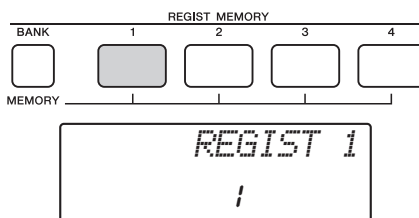

NOTE

- When the [SONG] lamp is lit, the Style or Riyaz settings will not be recalled even if you press the [REGISTRATION MEMORY] button to which the Style or Riyaz settings are memorized. To recall Style/Riyaz settings, make sure to press the [STYLE] or [RIYAZ] button beforehand.

Freezing the Style settings even if a different Registration number is selected

If you want to select different Registration Memory setups without changing the Style settings or Riyaz settings, simultaneously hold down the [VOICE] button and press the REGIST MEMORY number button.

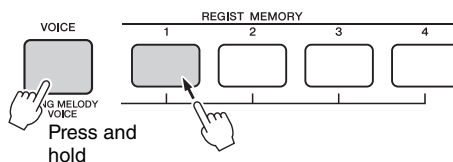

If you want to freeze the Style settings or Riyaz settings permanently, set the Freeze mode parameter to ON from Function display 058 (page 50).

NOTE

- For details about the parameters that can be memorized to Registration Memory, see the next page.

Backup Parameters and Initialization

Backup Parameters

The following data will be maintained even if the power is turned off and can be transferred then saved to a computer via Musicsoft Downloader as a single Backup file. For instructions, refer to “Computer-related Operations” (page 9).

- User Song data (page 28)
- Style data transferred from a computer and loaded to Style numbers 219–223 (page 57)
- Registration Memory data (page 31)
- Function Settings (page 48):
 - Tuning, Split Point, Touch Sensitivity, Style Volume, Song Volume, Riyaz Volume, Metronome Volume, Demo Group, Demo Play, Demo Cancel, Master EQ type, Your Tempo on/off, Auto Power Off Time setting, Battery Select, Freeze Mode

In addition to the Backup data above, all the Style data (including data that have not been loaded) and all the Song data will be maintained even if you turn off the power.

Parameters that can be memorized to Registration Memory

- **Style settings***
Style number, ACOMP on/off, Style volume, Track on/off
- **Riyaz settings****
Riyaz number, Riyaz volume, Section, Track on/off, Volume balance between Tabla/Mridangam 1 and 2, Volume balance between Tabla/Mridangam and Tanpura
- **Voice settings**
 - Main Voice settings:** Voice number and all settings of the related Functions
 - Dual Voice settings:** Dual on/off and all settings of the related Functions
 - Split Voice settings:** Split on/off and all settings of the related Functions
- **Effect settings**
Reverb Type, Chorus Type
- **Arpeggio settings**
Arpeggio on/off and all settings of the related Functions
- **Harmony settings**
Harmony on/off and all settings of the related Functions
- **Other settings**
Transpose, Pitch Bend Range, LIVE CONTROL Knob Assign, Split Point, Tempo, Pedal Function

* Available only when a Style is selected.

** Available only when a Riyaz is selected.

Initialization

This function erases the Backup data described above and Song/Style data, then restores all the default factory settings. As required, execute one of the following two procedures.

Backup Clear

This operation initializes the backup data. While holding down the highest white key on the keyboard, press the [⏻] (Standby/On) switch to turn the power on.

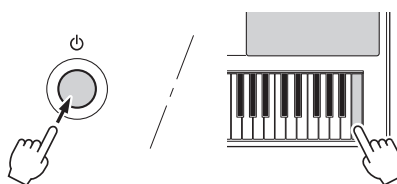

Flash Clear

This operation deletes all the Songs and Styles that have been transferred from a computer. Note that Style data loaded to Style numbers 219–223 will be maintained.

While simultaneously holding the highest white key and the three highest black keys, press the [⏻] (Standby/On) switch to turn the power on.

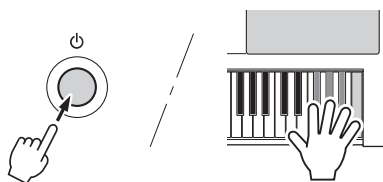

NOTICE

- *Keep in mind that this operation also deletes the data you have purchased. Be sure to save the important data to a computer via Musicsoft Downloader (MSD) software. For details, refer to “Computer-related Operations” (page 9).*

Handy Performance Features

Selecting a Reverb Type

The Reverb effect lets you play with a rich concert hall type ambience.

Although selecting a Style or Song will call up the optimum Reverb type for the entire sound, you can select a different Reverb type manually.

1 Press the [FUNCTION] button.



2 Use the CATEGORY [+] and [-] buttons to call up “Reverb” (Function 034).

After “Reverb” is shown for a few seconds, the current Reverb Type is shown.

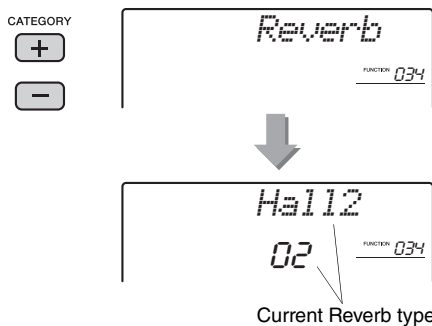

NOTE

- Some Songs and Styles use Reverb Types which cannot be selected via panel operation. If such a Song or Style is played back, “- - -” is shown on the display.

3 Rotate the dial to select a Reverb type.

Play the keyboard to check the sound. For information about the available Reverb types, refer to the Effect Type List in the Data List on the web-site.

Adjusting the Reverb depth

You can adjust the Reverb depth applied to the Main, Dual, and Split Voices individually via the same operations above. Regarding the item in Step 2, refer to the Function List on page 48.

Selecting a Chorus Type

The Chorus effect creates a thick sound that is similar to many of the same Voices being played in unison.

Although selecting a Style or Song will call up the optimum Chorus type for the entire sound, you can select a different Chorus type manually.

1 Press the [FUNCTION] button.



2 Use the CATEGORY [+] and [-] buttons to call up “Chorus” (Function 035).

After “Chorus” is shown for a few seconds, the current Chorus Type is shown.

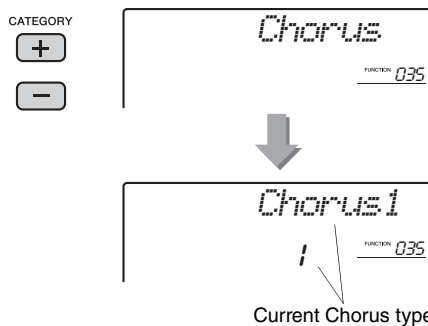

NOTE

- Some Songs and Styles use Chorus Types which cannot be selected via panel operation. If such a Song or Style is played back, “- - -” is shown on the display.

3 Rotate the dial to select a Chorus type.

Play the keyboard to check the sound. For information about the available Chorus types, refer to the Effect Type List in the Data List on the web-site.

Adjusting the Chorus depth

You can adjust the Chorus depth applied to the Main, Dual, and Split Voices individually via the same operations above. Regarding the item in Step 2, refer to the Function List on page 48.

Pitch Controls—Transpose

The overall pitch of the instrument (except for the Drum Kit Voices) can be shifted up or down by a maximum of 1 octave in semitone increments.

- 1 Press the [FUNCTION] button.



- 2 Use the CATEGORY [+] and [-] buttons to call up “Transpose” (Function 004).

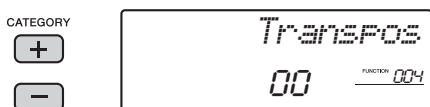

- 3 Use the dial to set the Transpose value between -12 and +12.

Pitch Controls—Tuning

The overall tuning of the instrument (except for the Drum Kit Voices) can be shifted up or down between 427 Hz and 453 Hz in approximately 0.2Hz increments. The default value is 440.0 Hz.

- 1 Press the [FUNCTION] button.



- 2 Use the CATEGORY [+] and [-] buttons to call up “Tuning” (Function 005).

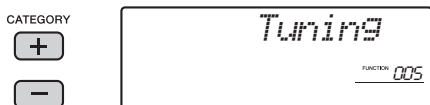

- 3 Use the dial to set the Tuning value.

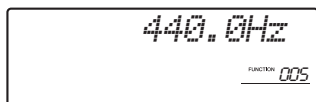

Pitch Controls—the PITCH BEND wheel

The PITCH BEND wheel can be used to add smooth pitch variations to notes you play on the keyboard. Roll the wheel upward to raise the pitch, or downward to lower the pitch.

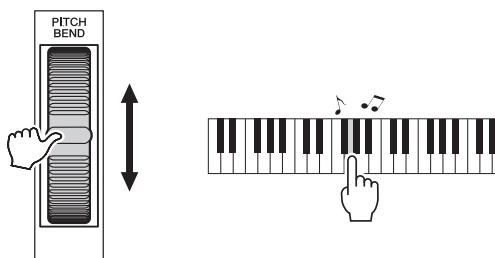

You can change the amount of pitch bend produced by the wheel. Refer to “Pitch Bend Range” in the Function List (page 48).

Calling Up Optimum Panel Settings—One Touch Setting (OTS)

The One Touch Setting feature automatically calls up the optimum panel settings, such as the Voice for the current Song, Style or Riyaz. To use this feature, select a Song, Style or Riyaz, and then select Voice number 000 OTS (page 16).

Changing the Touch Sensitivity of the Keyboard

The keyboard of this instrument is equipped with a Touch Response feature that lets you dynamically and expressively control the level of the Voices according to your playing strength.

- 1 Press the [FUNCTION] button.



- 2 Press the CATEGORY [+] or [-] button several times until “TouchSns” (Function 008) appears.

“TouchSns” is shown in the display for a few seconds, and the current Touch Sensitivity is shown.

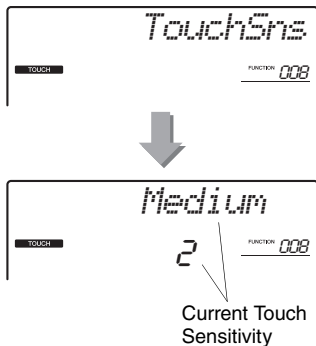

- 3 Use the dial to select a Touch Sensitivity setting between 1 and 4.

When “1”–“3” is selected, higher values produce greater (easier) volume variation in response to keyboard dynamics—i.e. greater sensitivity. When “4” (off) is selected, all notes will be played at the same volume no matter how strongly or softly you play the keys.

NOTE 1

- The initial default Touch Sensitivity value is “2”.

Selecting an EQ Setting for the Best Sound

Six different master equalizer (EQ) settings are provided to give you the best possible sound when listening through different reproduction systems—the instrument’s internal speakers, headphones, or an external speaker system.

- 1 Press the [FUNCTION] button.



- 2 Press the CATEGORY [+] or [-] button several times until “MasterEQ” (Function 036) appears.

“MasterEQ” is shown in the display for a few seconds, and the current Master EQ type appears.

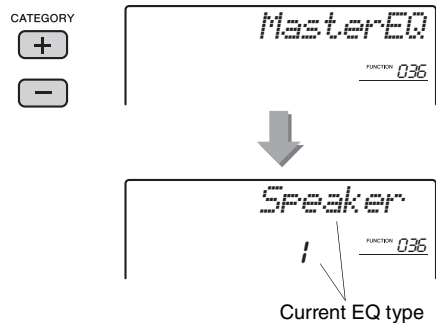

- 3 Use the dial to select the desired Master EQ type.

Master EQ types

1	Speaker	Optimum for listening via the instrument’s built-in speakers.
2	India	Optimum for listening Indian music. The mid-range is slightly cut, to better emphasize the characteristics of the Indian instrument sounds, resulting in clear and more powerful sounds.
3	Headphone	Optimum for headphones, or for listening via external speakers.
4	Boost	Results in more powerful sound. Depending on the selected Voice and Style, etc., the sound may be more subject to distortion than other EQ types.
5	Piano	Optimum for piano solo performance.
6	Bright	Lowers the mid range for a brighter sound.

Voice Settings

Selecting a Dual Voice

- 1 Hold down the [DUAL] button for longer than a second to call up “D.Voice” (Function 018).

“D.VOICE” is shown for a few seconds, then the current Dual Voice appears.

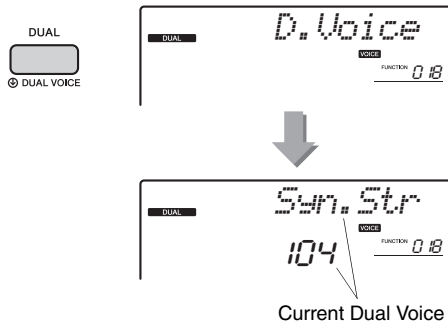

- 2 Rotate the dial to select the desired Dual Voice.

Selecting a Split Voice

- 1 Hold down the [SPLIT] button for longer than a second to call up “S.Voice” (Function 028).

“S.VOICE” is shown for a few seconds, then the current Split Voice appears.

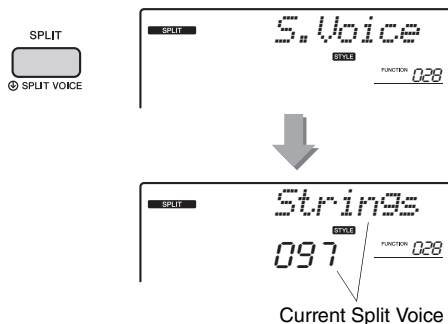

- 2 Rotate the dial to select the desired Split Voice.

Voice Editing

For each of the Main, Dual and Split Voices, you can edit the parameters such as volume, octave and depth of the Reverb and Chorus, allowing you to create new, custom sounds that best suit your musical needs.

- 1 Press the [FUNCTION] button.



- 2 Use the CATEGORY [+] and [-] buttons to call up the desired item.

Main Voice parameters are indicated as “M.*****,” Dual Voice parameters as “D.*****,” and Split Voice parameters as “S.*****.” For information about each parameter, refer to the Function List on page 48.

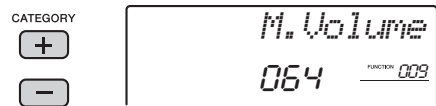

- 3 Rotate the dial to set the value.

Check the sound by playing the keyboard.

- 4 Repeat Steps 2–3 above to edit various parameters.

- 5 If necessary, memorize the settings to the Registration Memory (page 31).

The Voice-related settings are reset when a different Voice is selected. If you want to store the created sound for future recall, memorize the settings to the Registration Memory.

Parameters Assigned to the LIVE CONTROL Knobs

This section describes each of the parameters which can be assigned to the LIVE CONTROL Knobs (page 21).

1 RIYAZ

● Knob A: BALANCE 1

Adjusts the volume balance between the sounds of Tabla/Mridangam 1 and 2.

● Knob B: BALANCE 2

Adjusts the volume balance between the sounds of Tabla/Mridangam and Tanpura.

2 RIYAZ

● Knob A: TEMPO

Adjusts the tempo of Tabla/Mridangam playback while the Tanpura playback tempo is maintained. This follows typical Indian music stylistic conventions.

● Knob B: KEY

Raises or lowers the pitch of the Riyaz sound in semitones, with the exception of Tabla 1/Mridangam. This accurately simulates the characteristics of the Tabla, in which the lower sound is not affected by the tuning. Note that also the pitch of Tabla 2 may not be changed depending on the Riyaz pattern.

NOTE

- When Knob B is turned all the way left, only the pitch of the Tabla 2 sound is raised abruptly by an octave. This is due to a limitation in this instrument.

3 FILTER

Filter effects shape the sound by allowing only a specified range of frequencies to pass and/or by producing a resonance peak at the filter's "cutoff" frequency. Filter effects can be used to create a range of synthesizer-like sounds.

NOTE

- These effects are applied only to the Main/Dual Voices played on the keyboard.
- Filter effects can sometimes cause distortion in the bass frequencies.

● Knob A: CUTOFF

Adjusts the filter's cutoff frequency, and therefore the brightness of the sound. Turning the Knob to the left makes the sound more muffled or darker, while turning the Knob to the right makes the sound brighter.

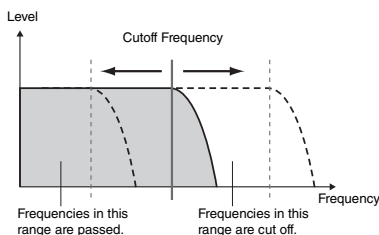

● Knob B: RESONANCE

Adjusts the amount of Resonance applied at the filter's cutoff frequency. Turning the Knob to the right will increase the Resonance to emphasize the frequencies at the cutoff frequency, and thus "strengthen" the perceived effect of the filter.

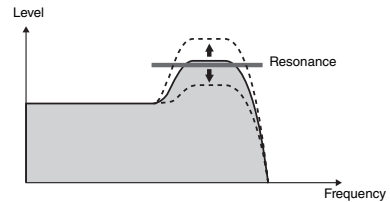

4 EFFECT

● Knob A: REVERB

Reproduces the acoustic ambience of a concert hall or club. Turning the Knob to the right will increase the Reverb depth.

● Knob B: CHORUS

Produces a layered "multi-instrument" effect. Turning the Knob to the right will increase the Chorus depth.

NOTE

- These effects are applied only to the Main/Dual Voices played on the keyboard.

5 EG (Envelope Generator)

Envelope Generator effects determine how the level of the sound varies over time. You can make the attack faster for a more percussive sound or slower for a violin-like sound, for example. Or you can lengthen or shorten the sustain to best match the music you're playing.

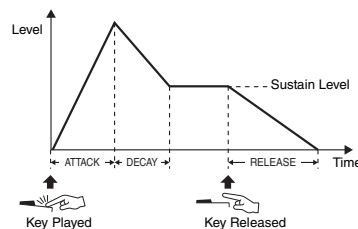

● Knob A: ATTACK

Adjusts the Attack Time (the amount of time it takes the sound to reach maximum level when a key is played). Turning the Knob to the right will increase the Attack Time, thus slowing down the attack rate.

● **Knob B: RELEASE**

Adjusts the Release Time (the amount of time it takes for the sound to decay to silence after a key is released). Turning the Knob to the right will increase the Release Time, thus make a longer sustain.

NOTE

- These effects are applied only to the Main/Dual Voices played on the keyboard.

6 STYLE FILTER

Same as “**3 FILTER.**” These effects are applied only to Style or Riyaz playback.

The chart below lists some interesting ways to use the various effects that can be assigned to the LIVE CONTROL Knobs.

Some Ideas for Using the LIVE CONTROL Knobs

Number/Effect		Try This
1	RIYAZ (BALANCE 1/ BALANCE 2)	Knob A adjusts the volume balance between the sounds of Tabla/Mridangam 1 (having the lower sound) and Tabla/Mridangam 2 (having the higher sound of Tabla/Mridangam). Knob B adjusts the volume balance between the sounds of the Tabla/Mridangam (assigned to the [TABLA 1] and [TABLA 2] buttons) and Tanpura (assigned to the [TANPURA 1]–[TANPURA 4] buttons). Play with these Knobs as the patterns loop, sing along if you wish, and create your own performance.
2	RIYAZ (TEMPO/KEY)	Knob A adjusts the tempo of Riyaz playback. Setting to the minimum left-most position results in half the default tempo, while setting to the maximum right-most position results in double the default tempo. The center position corresponds to the default tempo. Note that the tempo cannot exceed the range (11–280), and that the tempo of the Tanpura patterns will not change even if you rotate Knob A. Knob B raises or lowers the pitch of the Riyaz sound in semi-tones. Regarding the Tabla, only the higher sound (assigned to the [2] button) will be transposed. Rotating the knob leftward lowers the pitch while rotating the knob rightward raises the pitch. Use these knobs to set the desired tempo and key, sing along if you wish, and create your own performance!
3	FILTER	Select a synth-type lead or pad Voice (refer to the Voice List in the Data List on the website). Turn Knob B all the way up and operate Knob A while playing for some spacey, floating 1980’s effects.
4	EFFECT	Select a Voice that sounds as though it already has reverb and chorus effects applied, and turn Knob A and Knob B all the way down to hear the “direct” sound of the Voice. You can then turn the Knob A and Knob B settings up to add extra impact and richness to the Voice.
5	EG	Select an Indian Voice, and turn Knob B all the way up and Knob A to about the 3 o’clock position. This should give you a majestic, organ-like sound. The attack time is quite long so play the keys and hold them to let the sound come in fully. Ideal for slow pieces.
6	STYLE FILTER	Select Style 001 Dholly. Turn accompaniment on and start Style playback (page 22). Set Knob B to about 3 o’clock, and Knob A to about 8 o’clock. The overall sound of the Style should be a bit muffled, with the drums emphasized for solid rhythmic impact.

Arpeggio Settings

Synchronizing an Arpeggio to Song/Style/Riyaz Playback—Arpeggio Quantize

When you play the keyboard to trigger an Arpeggio (page 20) along with Song/Style/Riyaz playback, you'll need to play the notes with correct timing to keep the Arpeggio in synchronization with the other playback tracks. However, your actual timing may be slightly ahead of or behind the beat (or both). The “Arpeggio Quantize” function of this instrument will correct any slight imperfections in the timing (according to settings below), and then play back the Arpeggio appropriately.

- Synchronizing at the quarter notes
- Synchronizing at the 8th notes
- No synchronization with Style or Song playback

Although the Arpeggio Quantize value is pre-programmed for each Arpeggio Type, you can change the value manually.

1 Press the [FUNCTION] button.



2 Use the CATEGORY [+] and [-] buttons to call up “Quantize” (Function 042).

After “Quantize” is shown for a few seconds, the current Arpeggio Quantize value is shown.

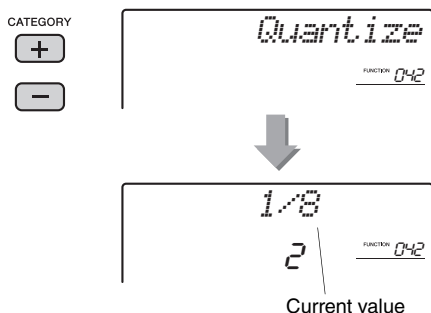

3 Rotate the dial to select a value from “OFF,” “1/8” and “1/16.”

- 1/8 Synchronizing at the quarter notes
- 1/16 Synchronizing at the 8th notes
- OFF No synchronization with Style or Song playback

Holding the Arpeggio Playback via the Footswitch

You can set the instrument so that Arpeggio playback continues even after the note has been released, by pressing the footswitch connected to the [SUSTAIN] jack.

1 Press the [FUNCTION] button.



2 Use the CATEGORY [+] and [-] buttons to call up “Pdl Func” (Function 061).

After “Pdl Func” is shown for a few seconds, the current setting is shown.

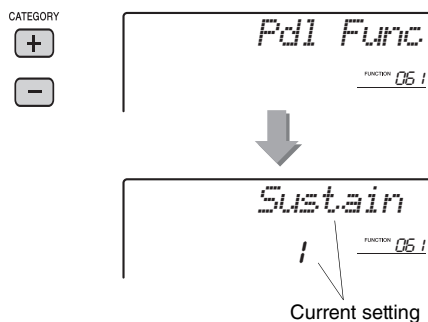

3 Rotate the dial to select “Arp Hold.”

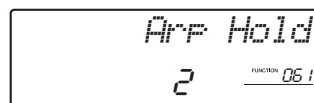

If you want to restore the footswitch function to sustain, select “Sustain.” If you want to use both hold and sustain functions, select “Sus+ArpH”.

4 Try playing Arpeggio with the footswitch.

Press the notes to trigger the Arpeggio, then press the footswitch. Even if you release the notes, Arpeggio playback will continue. To stop Arpeggio playback, release the footswitch.

Styles (Auto Accompaniment) and Riyaz patterns

Style Variations—Sections

Each Style consists of “Sections” that allow you to vary the arrangement of the accompaniment to match the Song you are playing.

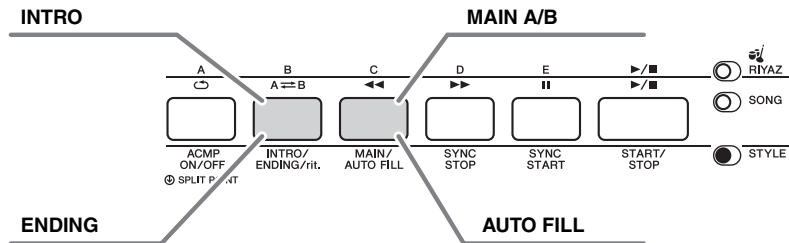

INTRO

This is used for the beginning of the Song. When the Intro finishes, Style playback shifts to the Main section. The length of the Intro (in measures) differs depending on the selected Style.

MAIN

This is used for playing the main part of the Song. Playback of the Main section repeats indefinitely until another Section’s button is pressed. There are two variations (A and B), and the Style playback sound changes harmonically in response on the chords you play with your left hand.

AUTO FILL

This is automatically added before changing to Main A or B.

ENDING

This is used for the ending of the Song. When the Ending finishes, the Style playback stops automatically. The length of the Ending (in measures) differs depending on the selected Style.

Reference

- 1 Press the [STYLE] button, then rotate the dial to select a Style.
- 2 Press the [ACMP ON/OFF] button to turn ACMP on.

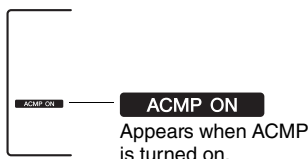

- 3 Press the [SYNC START] button to turn Synchro Start on.



Beat arrows flash.

● Synchro Start

When the Synchro Start is on, Style playback will begin as soon as you play a chord in the accompaniment range of the keyboard. To turn off the Synchro Start, press the [SYNC START] button.

- 4 Press the [MAIN/AUTO FILL] button to select Main A or Main B.



Current Section

5 Press the [INTRO/ENDING/rit.] button.



Now, you're ready to start Style playback from the Intro section.

6 Play a chord with your left hand to start playback of the Intro.

For this example, play a C major chord (as shown below). For information on how to enter chords, see "Chords" on page 44.

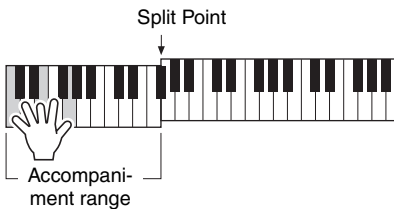

7 After the Intro finishes, play the keyboard according to the progression of the Song you are playing.

Play chords with your left hand while playing melodies with your right hand, and press the [MAIN/AUTO FILL] button as necessary. The Section will change to Fill-in then Main A or B.



Turning on/off each Track via the [TRACK CONTROL] button

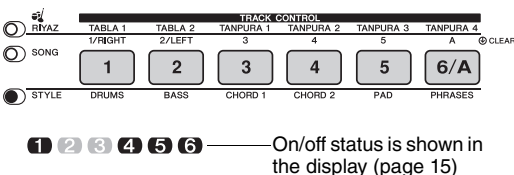

NOTE

• Up to two Track buttons can be pressed simultaneously for turning Tracks on or off.

8 Press the [INTRO/ENDING/rit.] button.



The Section switches to the Ending. When the Ending is finished, Style playback stops automatically. You can have the Ending gradually slow down (ritardando) by pressing the [INTRO/ENDING/rit.] button again while the Ending is playing back.

NOTE

• Style numbers 035, 194, 206–218 have no rhythm parts, so no rhythm will play. When one of these Styles is selected, turn ACMP on, then specify the chord in the Auto Accompaniment area to play Style parts other than the Rhythm part.

Synchro Stop

When you press the [SYNC/STOP] button to turn on this function, the Style will only play while pressing chords in the Accompaniment range of the keyboard. Releasing all the notes will stop Style playback. This makes it easy to add rhythmic breaks as you perform, simply by releasing your hand from the Accompaniment range of the keyboard.

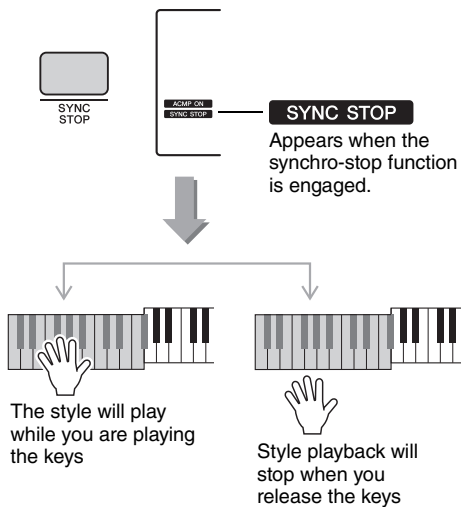

Reference

Riyaz Variations

Each Riyaz features five Variations A–E via the Tabla/Mridangam sound. These five variations can be alternated via the [A]–[E] buttons during playback, allowing you to add dynamic variations to the performance.

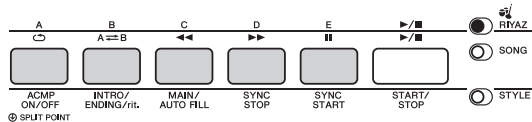

In addition, four phrase variations via the Tanpura sound are provided commonly for all the Riyaz patterns. These four variations can be alternated via the [TANPURA 1]–[TANPURA 4] buttons.

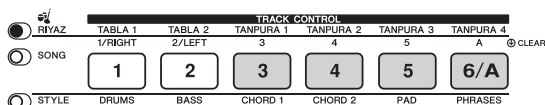

Unlike the Styles, the Riyaz patterns do not have the variations dedicated to the beginning or ending of the Song, such as Intro and Ending. The Riyaz playback will continue until stopped manually.

Changing the Tempo

A Style or Riyaz can be played at any tempo you desire—fast or slow.

- 1 Press the **TEMPO [TAP]** button to call up the Tempo value in the display.

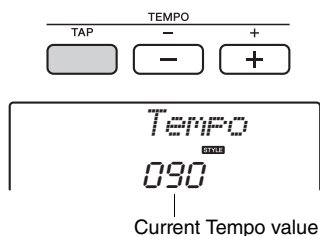

- 2 Rotate the dial to set a tempo from 011 to 280.

Press the TEMPO [+] and [-] buttons simultaneously to instantly reset the value to the default tempo of the current Style, Riyaz or Song. You can change the tempo during playback by pressing the TEMPO [TAP] button just twice at the required tempo.

NOTE 1

- The above operation applies also to Song or Arpeggio playback tempo.

Tap Start

You can start play back of the Riyaz, Style or Song by simply tapping the TEMPO [TAP] button at the required tempo—four times for time signatures in 4 (4/4, etc.), and three times for time signatures in 3 (3/4, etc.).



Adjusting the Volume of the Style or Riyaz

You can adjust the volume balance between Style or Riyaz playback and keyboard performance.

- 1 Press the **[FUNCTION]** button.



- 2 Use the **CATEGORY [+]** and **[-]** buttons to call up “StyleVol” (Function 001) or “RiyazVol” (Function 003).

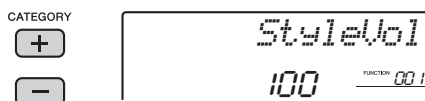

- 3 Rotate the dial to set the volume between 000 and 127.

Setting the Split Point

The point on the keyboard that separates the left-hand range and the right-hand range of the keyboard is called the “Split Point.”

When a Style is selected and ACMP is on, the notes played to the left of the Split Point are used to specify the chord for Style playback. When the Split function is on, the notes played to the left of the Split Point are used to play the Split Voice.

The initial default Split Point is key number 54 (the F#2 key), but you can change it to another key.

1 Press the [FUNCTION] button.



2 Use the CATEGORY [+] and [-] buttons to call up “SplitPnt” (Function 007).

You can call up this display also by pressing the [STYLE] then holding the [ACMP ON/OFF] button for longer than a second.

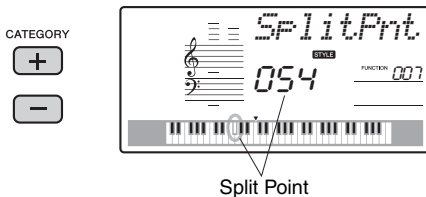

3 Rotate the dial to set the Split Point between 036 (C1) and 096 (C6).

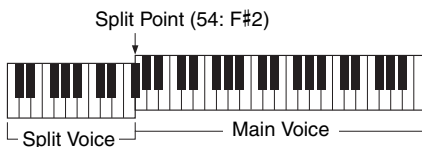

NOTE 1

- The Split Point set here is applied common to the Style and Voice.
- During the Lesson playback, the Split Point cannot be changed.

Playing Chords Without Style Playback

If you press the [STYLE] button, press the [ACMP ON/OFF] button to turn ACMP on (the ACMP ON icon appears), and play the chord in the Left hand range of the keyboard (with SYNC START off), the chord sound will be heard without Style playback. This is referred to as “Stop Accompaniment.” The specified chord will be shown in the display, and affects the Harmony function (page 19).

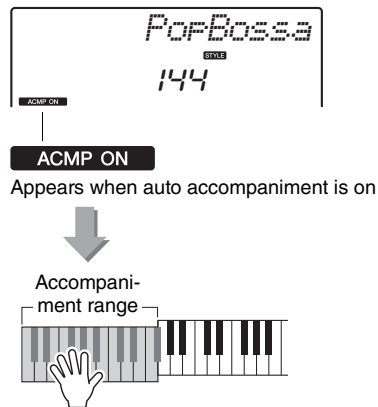

Chord Types for Style Playback

For users who are new to chords, this chart features common chords. Since there are many useful chords and many different ways to use them musically, refer to commercially available chord books for further details.

★ indicates the root note.

Major	Minor	Seventh	Minor Seventh	Major Seventh
C 	Cm 	C7 	Cm7 	CM7 
D 	Dm 	D7 	Dm7 	DM7 
E 	Em 	E7 	Em7 	EM7 
F 	Fm 	F7 	Fm7 	FM7 
G 	Gm 	G7 	Gm7 	GM7 
A 	Am 	A7 	Am7 	AM7 
B 	Bm 	B7 	Bm7 	BM7 

- Inversions can be used as well as in "root" position—with the following exceptions: m7, m7^b5, 6, m6, sus4, aug, dim7, 7^b5, 6(9), sus2
- Inversion of the 7sus4 and m7(11) chords are not recognized if the notes are omitted.
- When playing a chord which cannot be recognized by this instrument, nothing is shown on the display. In such a case, only the rhythm and bass parts will be played.

Easy Chords

This method lets you easily play chords in the accompaniment range of the keyboard using only one, two, or three fingers.

For root "C"



To play a major chord
Press the root note (★) of the chord.

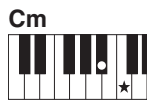

To play a minor chord
Press the root note together with the nearest black key to the left of it.



To play a seventh chord
Press the root note together with the nearest white key to the left of it.



To play a minor seventh chord
Press the root note together with the nearest white and black keys to the left of it (three keys altogether).

Looking Up Chords Using the Chord Dictionary

The Dictionary function is useful when you know the name of a certain chord and want to quickly learn how to play it.

1 Press and hold the [LESSON] button for longer than a second to call up “Dict.”

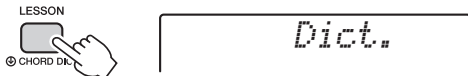

Hold for longer than a second.

This operation will divide the entire keyboard into the three ranges as illustrated below.

- The range to the right of “ROOT ▶”:
Lets you specify the Chord Root, but produces no sound.
- The range between “CHORD TYPE ▶” and “ROOT ▶”:
Lets you specify the Chord Type, but produces no sound.
- The range to the left of “CHORD TYPE ▶”:
Lets you play and confirm the Chord specified in the above two ranges.

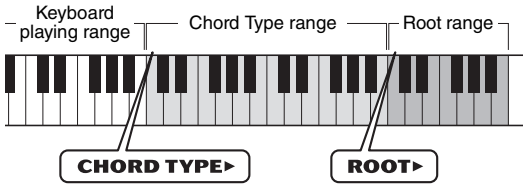

2 As an example, learn how to play a GM7 (G major seventh) chord.

- 2-1. Press the “G” key in the section to the right of “ROOT ▶” so that the “G” is shown as the root note.

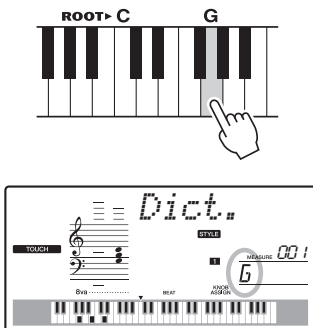

- 2-2. Press the key labeled “M7” in the section between “CHORD TYPE ▶” and “ROOT.” The notes you should play for the specified chord (root note and chord type) are conveniently shown in the display, both as notation and in the keyboard diagram.

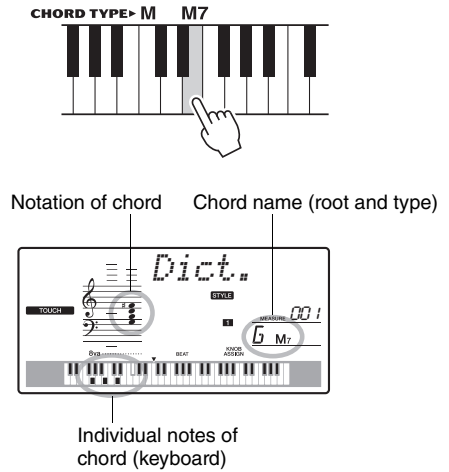

To call up possible inversions of the chord, press the [+ / YES] / [- / NO] buttons.

NOTE

- About major chords: Simple major chords are usually indicated only by the root note. For example, “C” refers to C major. However, when specifying major chords here, make sure to select “M” (major) after pressing the root note.

3 Following the notation and keyboard diagram in the display, try playing a chord in the range to the left of “CHORD TYPE ▶.”

When you’ve played the chord properly, a bell sound signals your success and the chord name in the display flashes.

Song Settings

BGM (Background Music) Playback

With the default setting, pressing the [DEMO] button will play back only a few of the internal Songs repeatedly. This setting can be changed so that, for example, all internal Songs are played, or all Songs transferred to the instrument from a computer are played back, letting you use the instrument as a background music source. Five playback group settings are provided. Simply select the one that suits your needs.

1 Hold down the [DEMO] button for longer than a second.

“DemoGrp” is shown in the display for a few seconds, followed by the current repeat playback target.

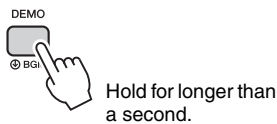

2 Rotate the dial to select a repeat playback group from the table below.

Demo	Preset Songs 001–003
Preset	All preset Songs
User	All User Songs
Download	All Songs transferred from a computer
USB	All Songs (MIDI files) in the connected USB Flash Drive

3 Press the [DEMO] button to start playback.

To skip to the next Song, press the [+ / YES] button. To skip to the previous Song, press the [- / NO] button.

To stop playback, press the [DEMO] button again.

Random Song Playback

The order of Song repeat playback via the [DEMO] button can be changed between the numerical order and random order.

1 Press the [FUNCTION] button.



2 Press the CATEGORY [+] and [-] buttons several times to call up “PlayMode” (Function 056).

“PlayMode” is shown for a few seconds, followed by the current playback mode, “Normal” or “Random.”

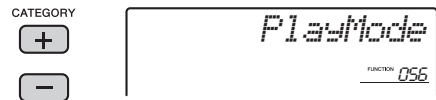

When the DemoGrp is set to “Demo,” this parameter cannot be set.

3 Rotate the dial to select “Random.”

To return to the numerical order, select “Normal.”

4 Press the [DEMO] button to start playback.

To skip to other Songs, press the [+ / YES] button or the [- / NO] button.

To stop playback, press the [DEMO] button again.

Tempo Setting of the Song

This operation is same as that of the Style and Riyaz.
Refer to page 42.

Tap Start

This operation is same as that of the Style and Riyaz.
Refer to page 42.

Song Volume

- 1 Press the [FUNCTION] button.



- 2 Press the CATEGORY [+] and [-] buttons several times to call up “SongVol” (Function 002).

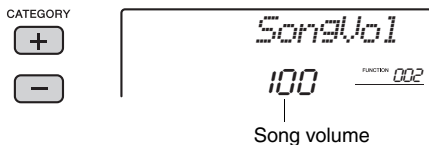

- 3 Rotate the dial to set the Song volume between 000 and 127.

[NOTE]

- Song volume can be adjusted while a Song is selected.

Melody Voice Setting of the Pre-set Song

You can change the Melody Voice of the current Pre-set Song temporarily to any other desired Voice.

- 1 Press the [SONG] button, select the desired Pre-set Song, then start playback.



- 2 Press the [VOICE] button, then rotate the dial to select the desired Voice.

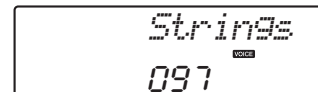

- 3 Hold down the [VOICE] button for longer than a second.

After “SONG MELODY VOICE” is shown for a few seconds, the Melody Voice of the Song will be changed to that selected in Step 2.



Hold for longer than a second.

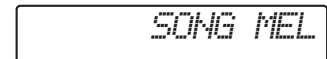

The Functions

The “Functions” provide access to a range of detailed instrument parameters such as Tuning, Split Point, Voices and Effects. Take a look at the Function List (pages 48–50). When you find the desired Function you want to change, follow the instructions below.

Basic Procedure in the Function Display

1 Find the desired item in the Function List on pages 48–50.

2 Press the [FUNCTION] button.

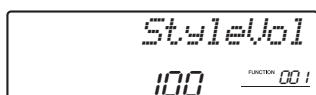

3 Press the CATEGORY [+] and [-] buttons several times until the desired item appears.

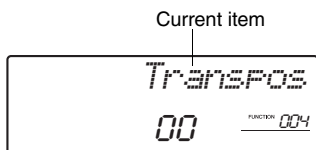

4 Use the dial, the [+ / YES] and [- / NO] buttons, or the [0]–[9] number buttons to set the value of the selected function.

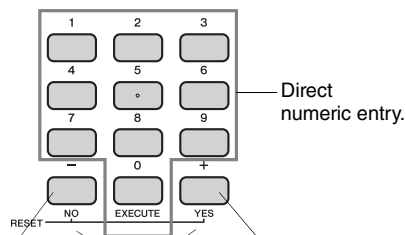

- Decrement value by 1.
- Cancel
- Press simultaneously to recall the default setting.
- Increment value by 1.
- Execute

Some Function settings are maintained even if you turn off the power, and can be transferred to the computer as Backup Data (page 32).

Function List

Function Number	Function	Display	Range/Settings	Default Value	Description
Volume					
001	Style Volume	<i>StyleVol</i>	000–127	100	Refer to page 42.
002	Song Volume	<i>SongVol</i>	000–127	100	Refer to page 47.
003	Riyaz Volume	<i>RiyazVol</i>	000–127	100	Refer to page 42.
Overall					
004	Transpose	<i>Transpos</i>	-12–12	0	Refer to page 34.
005	Tuning	<i>Tuning</i>	427Hz–453Hz (in approximately 0.2Hz increments)	440.0Hz	Refer to page 34.
006	Pitch Bend Range	<i>PBRange</i>	01–12	2	Sets the range over which you can control pitch by using the PITCH BEND wheel (page 34), in semitone increments.
007	Split Point	<i>SplitPnt</i>	036–096 (C1–C6)	54 (F#2)	Refer to page 43.
008	Touch Sensitivity	<i>TouchSns</i>	1 (Soft), 2 (Medium), 3 (Hard), 4 (Off)	2 (Medium)	Refer to page 35.
Main Voice (page 16)					
009	Volume	<i>M. Volume</i>	000–127	*	Determines the volume of the Main Voice.
010	Octave	<i>M. Octave</i>	-2 – +2	*	Determines the octave range for the Main Voice.
011	Pan	<i>M. Pan</i>	L63–C–r63	*	Determines the stereo pan position of the Main Voice. A value of “L” results in the sound being panned full left, while a value of “r” results in the sound being panned full right.
012	Reverb Depth	<i>M. Reverb</i>	000–127	*	Determines how much of the Main Voice’s signal is sent to the Reverb effect.
013	Chorus Depth	<i>M. Chorus</i>	000–127	*	Determines how much of the Main Voice’s signal is sent to the Chorus effect.
014	Attack Time	<i>M. Attack</i>	000–127	64	Determines how fast the volume of the Main Voice reaches the Attack level when the note is pressed. The larger the value, the faster the attack rate. The smaller the value, the slower the attack rate.

Function Number	Function	Display	Range/Settings	Default Value	Description
015	Release Time	<i>M.Releas</i>	000-127	64	Determines how fast the volume of the Main Voice falls to 0 when the note is released. The larger the value, the longer the sustain. The smaller the value, the shorter the sustain.
016	Filter Cutoff	<i>M.Cutoff</i>	000-127	64	Determines the Filter Cutoff Frequency (page 37) of the Main Voice.
017	Filter Resonance	<i>M.Reso.</i>	000-127	64	Determines the Filter Resonance (page 37) of the Main Voice.
Dual Voice (page 17)					
018	Dual Voice	<i>D.Voice</i>	001-753	*	Selects a Dual Voice.
019	Volume	<i>D.Volume</i>	000-127	*	Determines the volume of the Dual Voice.
020	Octave	<i>D.Octave</i>	-2 - +2	*	Determines the octave range for the Dual Voice.
021	Pan	<i>D.Pan</i>	L63-C-r63	*	Determines the stereo pan position of the Dual Voice. A value of "L" results in the sound being panned full left; a value of "r" results in the sound being panned full right.
022	Reverb Depth	<i>D.Reverb</i>	000-127	*	Determines how much of the Dual Voice's signal is sent to the Reverb effect.
023	Chorus Depth	<i>D.Chorus</i>	000-127	*	Determines how much of the Dual Voice's signal is sent to the Chorus effect.
024	Attack Time	<i>D.Attack</i>	000-127	64	Determines how fast the volume of the Dual Voice reaches the Attack level when the note is pressed. The larger the value, the faster the attack rate. The smaller the value, the slower the attack rate.
025	Release Time	<i>D.Releas</i>	000-127	64	Determines how fast the volume of the Dual Voice falls to 0 when the note is released. The larger the value, the longer the sustain. The smaller the value, the shorter the sustain.
026	Filter Cutoff	<i>D.Cutoff</i>	000-127	64	Determines the Filter Cutoff Frequency (page 37) of the Dual Voice.
027	Filter Resonance	<i>D.Reso.</i>	000-127	64	Determines the Filter Resonance (page 37) of the Dual Voice.
Split Voice (page 17)					
028	Split Voice	<i>S.Voice</i>	001-753	86 (Strings)	Selects a Split Voice.
029	Volume	<i>S.Volume</i>	000-127	*	Determines the volume of the Split Voice.
030	Octave	<i>S.Octave</i>	-2 - +2	*	Determines the octave range for the Split Voice.
031	Pan	<i>S.Pan</i>	L63-C-r63	*	Determines the stereo pan position of the Split Voice. A value of "L" results in the sound being panned full left; a value of "r" results in the sound being panned full right.
032	Reverb Depth	<i>S.Reverb</i>	000-127	*	Determines how much of the Split Voice's signal is sent to the Reverb effect.
033	Chorus Depth	<i>S.Chorus</i>	000-127	*	Determines how much of the Split Voice's signal is sent to the Chorus effect.
Effects					
034	Reverb Type	<i>Reverb</i>	01-10	**	Refer to page 33.
035	Chorus Type	<i>Chorus</i>	01-05	**	Refer to page 33.
036	Master EQ Type	<i>MasterEQ</i>	1 (Speaker), 2 (India), 3 (Headphone), 4 (Boost), 5 (Piano), 6 (Bright)	1 (Speaker)	Refer to page 35.
037	Wide Type	<i>Wide</i>	1-4	4 (Wide Off)	Determines the Ultra-Wide Stereo type. Higher values produce a greater Wide effect.
Harmony (page 19)					
038	Harmony Type	<i>HarnType</i>	01-26	*	Determines the Harmony type.
039	Harmony Volume	<i>HarnVol</i>	000-127	*	Determines the volume of the Harmony effect
Arpeggio (page 20)					
040	Arpeggio Type	<i>ARP Type</i>	001-162	*	Determines the Arpeggio type.
041	Arpeggio Velocity	<i>ARP Velo</i>	1(Original), 2(Key)	*	When "Key" is selected, the velocities of Arpeggio playback are determined by your playing strength. When "Original" is selected, the velocities of Arpeggio playback are determined by the original setting regardless of your playing strength.
042	Arpeggio Quantize	<i>Quantize</i>	1(OFF), 2(1/8), 3(1/16)	*	Refer to page 39.
MIDI***					
043	Local Control	<i>Local</i>	ON/OFF	ON	Determines whether the instrument's keyboard controls the internal tone generator (ON) or not (OFF). When you record your keyboard performance to the application software on the computer via MIDI, set this parameter to OFF.
044	External Clock	<i>ExtClock</i>	ON/OFF	OFF	Determines whether the instrument synchronizes to the internal clock (OFF) or an external clock (ON). When you record your keyboard performance to the application software on the computer via MIDI, set this parameter to ON.

Function Number	Function	Display	Range/Settings	Default Value	Description
045	Keyboard Out	<i>KbdOut</i>	ON/OFF	ON	Determines whether MIDI messages generated via keyboard performance are transmitted (ON) or not (OFF) from the [USB TO HOST] terminal.
046	Style Out	<i>StyleOut</i>	ON/OFF	OFF	Determines whether MIDI messages generated via Style playback are transmitted (ON) or not (OFF) from the [USB TO HOST] terminal.
047	Song Out	<i>SongOut</i>	ON/OFF	OFF	Determines whether MIDI messages generated via Song playback are transmitted (ON) or not (OFF) from the [USB TO HOST] terminal.
048	Initial Send	<i>InitSend</i>	YES/NO	-	Lets you send the data of the panel settings to a computer. Press [+ / YES] to send, or press [- / NO] to cancel. This operation should be done immediately after starting the Recording operation on the computer.
Metronome (page 18)					
049	Time Signature Numerator	<i>TimesigN</i>	00–60	**	Determines the time signature of the Metronome.
050	Time Signature Denominator	<i>TimesigD</i>	Half note, Quarter note, Eighth note, Sixteenth note	**	Determines the length of each metronome beat.
051	Metronome Volume	<i>MtrVol</i>	000–127	100	Determines the volume of the Metronome.
Lesson (page 26)					
052	Lesson Track (R)	<i>R-Part</i>	GuideTrack1–16, OFF	1	Determines the guide track number for your right hand lesson. The setting is only effective for Songs in SMF format 0 transferred from a computer.
053	Lesson Track (L)	<i>L-Part</i>	GuideTrack1–16, OFF	2	Determines the guide track number for your left hand lesson. The setting is only effective for Songs in SMF format 0 transferred from a computer.
054	Your Tempo	<i>YourTemp</i>	ON/OFF	ON	This parameter is for Lesson 3 “Waiting.” When set to ON, playback tempo will change to match the speed at which you are playing. When set to OFF, playback tempo will be maintained regardless of the speed at which you are playing.
Demo (page 24)					
055	Demo Group	<i>DemoGrp</i>	1 (Demo) / 2 (Preset) / 3 (User) / 4 (Download) / 5 (USB)	1 (Demo)	Refer to page 46.
056	Demo Play Mode	<i>PlayMode</i>	1 (Normal) / 2 (Random)	1 (Normal)	Refer to page 46.
057	Demo Cancel	<i>D-Cancel</i>	ON/OFF	OFF	Determines whether Demo cancel is enabled or not. When this is set to ON, the Demo Song will not play, even if the [DEMO] button is pressed.
Registration Memory (page 31)					
058	Freeze Mode	<i>Freeze</i>	ON/OFF	OFF	When set to on, the Style and the Riyaz related settings are maintained even if you press another Registration Memory number button.
Auto Power Off (page 14)					
059	Auto Power Off Time	<i>AutoOff</i>	OFF, 5/10/15/30/60/120 (min.)	30 minutes	Specifies the time that will elapse before the instrument’s power is automatically turned off.
Battery (page 12)					
060	Battery Type	<i>Battery</i>	1 (Alkaline) / 2 (Ni-MH)	1 (Alkaline)	Selects the type of batteries you have installed to this instrument.
Pedal Function (page 20)					
061	Pedal Function	<i>Pdl Func</i>	1 (Sustain) / 2 (Arp Hold) / 3 (Sus+ArpH) / 4 (Sostenut)	1 (Sustain)	Determines the function of the footswitch connected to the [SUSTAIN] jack (page 13). When “1 (Sustain)” or “4 (Sostenut)” is selected, the footswitch works as a damper pedal or sostenuto pedal as on an acoustic piano. Note that sustain does not affect the Split Voice, while sostenuto affects only the Split Voice when Split is on. When “2 (Arp Hold)” is selected, pressing the footswitch maintains Arpeggio playback even if you release the notes (page 39). When “3 (Sus+ArpH)” is selected, both the Arpeggio Hold and Sustain functions are assigned to the footswitch.

* The appropriate value is automatically set for each Voice combination.
 ** The appropriate value is automatically set for each Song, Style or Riyaz.
 *** For details, refer to “Computer-related Operations” (page 9).

USB Flash Drive Operations

By connecting the USB Flash Drive device to the [USB TO DEVICE] terminal, you can save the data created on this instrument, such as User Song and parameter settings. The saved data can be recalled to this instrument again for the future use.

IMPORTANT

- It is recommended to use the AC adaptor when executing USB Flash Drive operations, since battery power may not be reliable enough to last through these crucial operations. When you try executing certain functions, the “Use Adaptor” indication may appear and the selected function cannot be executed.

Precautions when using the [USB TO DEVICE] terminal

This instrument features a built-in [USB TO DEVICE] terminal. When connecting a USB device to the terminal, be sure to handle the USB device with care. Follow the important precautions below.

NOTE

- For more information about the handling of USB devices, refer to the owner’s manual of the USB device.

● Compatible USB devices

- USB flash drive

Other USB devices such as a USB hub, computer keyboard or mouse cannot be used.

The instrument does not necessarily support all commercially available USB devices. Yamaha cannot guarantee operation of USB devices that you purchase. Before purchasing a USB device for use with this instrument, please visit the following web page: <https://download.yamaha.com/>

Although USB devices 1.1 to 3.0 can be used on this instrument, the amount of time for saving to or loading from the USB device may differ depending on the type of data or the status of the instrument.

NOTICE

- The rating of the [USB TO DEVICE] terminal is a maximum of 5V/500mA. Do not connect USB devices having a rating above this, since this can cause damage to the instrument itself.

● Connecting a USB device

When connecting a USB device to the [USB TO DEVICE] terminal, make sure that the connector on the device is appropriate and that it is connected in the proper direction.

NOTICE

- Avoid connecting or disconnecting the USB device during playback/recording and file management operations (such as Save, Delete and Format), or when accessing the USB device. Failure to observe this may result in “freezing” of the operation of the instrument or corruption of the USB device and the data.
- When connecting then disconnecting the USB device (and vice versa), make sure to wait a few seconds between the two operations.
- Do not use an extension cable when connecting a USB device.

Using a USB Flash Drive

By connecting the instrument to a USB flash drive, you can save data you’ve created to the connected device, as well as read data from the connected device.

● Number of USB flash drives that can be used

Only one USB flash drive can be connected to the [USB TO DEVICE] terminal.

● Formatting a USB flash drive

You should format the USB flash drive only with this instrument (page 53). A USB flash drive formatted on another device may not operate properly.

NOTICE

- The format operation overwrites any previously existing data. Make sure that the USB flash drive you are formatting does not contain important data. Proceed with caution, especially when connecting multiple USB flash drive.

● To protect your data (write-protect)

To prevent important data from being inadvertently erased, apply the write-protect provided with each USB flash drive. If you are saving data to the USB flash drive, make sure to disable write-protect.

● Turning off the instrument

When turning off the instrument, make sure that the instrument is NOT accessing the USB flash drive by playback/recording or file management (such as during Save, Copy, Delete and Format operations). Failure to do so may corrupt the USB flash drive and the data.

Connecting a USB Flash Drive

- 1 Connect a USB Flash Drive to the [USB TO DEVICE] terminal, being careful to insert it with the proper orientation.

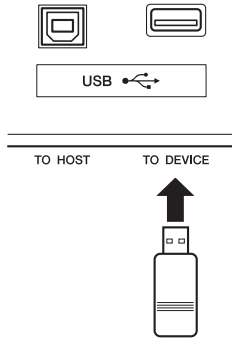

- 2 Wait until “USB” appears on the left corner of the display.

The “USB” indication confirms that the connected USB Flash Drive has been mounted or recognized.

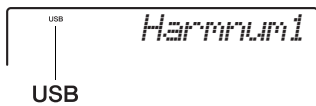

- 3 Hold down the [FUNCTION] button to call up the File Control display.



Hold for longer than a second.

- If “UnFormat” followed by “Format?” appears:

This indicates that the connected USB Flash Drive has not been formatted, and cannot be mounted or recognized. Execute the Format operation by following the instructions starting with Step 2 on page 53.

- 4 Rotate the dial to call up the desired File Control function, then execute it.

For details, refer to the table below.

Display	File Control function	Page
Load STY	Loading a Style File	57
Load USR	Loading User Data from a USB Flash Drive	56
Save SMF	Saving a User Song as SMF to a USB Flash Drive	55
Save USR	Saving User Data to a USB Flash Drive	54
Del SMF	Deleting a SMF File in a USB Flash Drive	58
Del USR	Deleting a User File in a USB Flash Drive	58
Format?	Formatting a USB Flash Drive	53
Exit?	Exiting from a File Control display	59

Messages may appear on the display during File Control procedures to aid in smooth operation. Refer to the Message List on page 59 for details.

NOTE

- No sound will be produced if the keyboard is played while the file control display is showing, and only buttons related to File Control operations will be active.

NOTE

The File Control display cannot be called up in the following situations.

- During playback of Style, Riyaz, or Song
- When “USB” does not appear even if you have connected a USB Flash Drive to the [USB TO DEVICE] terminal.

Formatting a USB Flash Drive

The Format operation lets you prepare commercially available USB Flash Drive for use with this instrument is called “Format.”

- 1 Hold the [FUNCTION] button for longer than a second to call up the File Control display.
- 2 Use the CATEGORY [+] and [-] buttons to call up “Format?.”



- 3 Press the [0/EXECUTE] button. A confirmation message will appear. To cancel the operation, press the [-/NO] button.

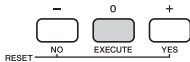

- 4 Press the [0/EXECUTE] button again or the [+ /YES] button to execute the Format operation.

After a while, a message indicating completion of the operation appears, and the “USER FILES” folder will be created on the root directory in the USB Flash Drive.

NOTICE

- The Format operation cannot be cancelled during execution. Never turn off the power or disconnect the USB Flash Drive during the operation. Doing so may result in data loss.

- 5 Press the [FUNCTION] button to exit from the File Control display.



Recognizable file location in the USB Flash Drive for Song playback (page 24)

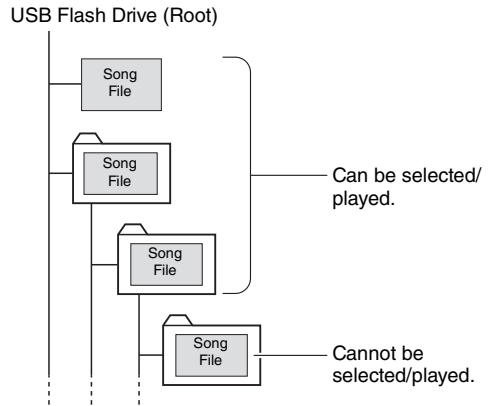

IMPORTANT

- In order to play data copied to a USB Flash Drive from a computer or other device, the data must be stored either in the USB Flash Drive’s root directory or a first-level/second-level folder in the root directory. Data stored in third-level-folders created inside a second-level folder cannot be selected and played by this instrument.

NOTE

- If playback of an external Song (created via a different instrument or computer) produces the distorted sound, decrease the Song Volume (page 47) to reduce the distortion then adjust the Master Volume (page 14).

Saving User Data to a USB Flash Drive

The following data created on this instrument comprise the “User Data.”

- All 10 User Songs
- Styles which have been transferred from a computer then loaded to Style numbers 219–223.
- All the Registration Memory settings

The User Data can be saved as a single “User File” (.usr) to a USB Flash Drive.

NOTE

- The extension (.usr) of the User File will not be shown on the display of this instrument. Confirm the extension on the computer display when connecting the USB Flash Drive to a computer.

1 Hold the [FUNCTION] button for longer than a second to call up the File Control display.

2 Use the CATEGORY [+] and [-] buttons to call up “Save USR.”

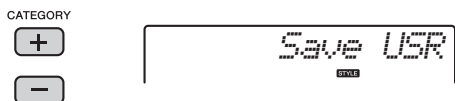

3 Press the [0/EXECUTE] button.

As the target file name, “USER***” (***: number) appears on the display. If desired, rotate the dial to select a different file name from “USER001”–“USER100.”



4 Press the [0/EXECUTE] button again.

A confirmation message will appear. To cancel the operation, press the [-/NO] button.

Overwriting existing files

If a file that already contains data is selected as the target user file, an overwrite confirmation message will appear.

5 Press the [0/EXECUTE] button again, or the [+ /YES] button to execute the Save operation.

After a while, a message indicating completion of the operation appears, and a User file (.usr) will be saved in a “USER FILES” folder which will automatically be created on the USB Flash Drive.

NOTICE

- The Save operation cannot be cancelled during execution. Never turn off the power or disconnect the USB Flash Drive during the operation. Doing so may result in data loss.

NOTE

- The amount of time required for this operation may vary depending on the condition of the USB Flash Drive.

6 Press the [FUNCTION] button to exit from the File Control display.



NOTE

- If you want to recall the User file (.usr) to this instrument again, execute the Load operation (page 56).

Saving a User Song as SMF to a USB Flash Drive

A User Song can be converted to SMF (Standard MIDI File) format 0 and saved to a USB Flash Drive.

SMF (Standard MIDI File) format

With this format, various events via the keyboard performance such as note on/off and Voice selection will be recorded as MIDI data. The SMF Format 0 and Format 1 are available. A large number of MIDI devices are compatible with SMF Format 0, and most commercially available Song file (MIDI file) is provided in SMF Format 0.

1 Hold the [FUNCTION] button for longer than a second to call up the File Control display.

2 Use the CATEGORY [+] and [-] buttons to call up “Save SMF.”

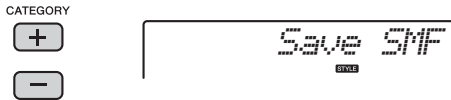

3 Press the [0/EXECUTE] button.

As the target User Song, “USER**” (**: number 1–10) appears on the display. If desired, rotate the dial to select a different User Song from “USER01”–“USER10.”



4 Press the [0/EXECUTE] button again.

As the target file name on the USB Flash Drive, “SONG***” (***: number 1–100) appears on the display. If desired, rotate the dial to select the different file.



5 Press the [0/EXECUTE] button again.

A confirmation message will appear. To cancel the operation, press the [-/NO] button.

Overwriting existing files

If a file that already contains data is selected, an overwrite confirmation message will appear.

6 Press the [0/EXECUTE] button again, or the [+ /YES] button to execute the Save operation.

After a while, a message indicating completion of the operation appears, and a User Song will be saved as the SMF format 0 in a “USER FILES” folder which will automatically be created on the USB Flash Drive.

NOTICE

- The Save operation cannot be cancelled during execution. Never turn off the power or disconnect the USB Flash Drive during the operation. Doing so may result in data loss.

NOTE

- The amount of time required for this operation may vary depending on the condition of the USB Flash Drive.

7 Press the [FUNCTION] button to exit from the File Control display.



Loading User Data from a USB Flash Drive

A User data (page 54) saved as a User file (.usr) to the USB Flash Drive can be loaded to this instrument.

NOTICE

- Loading a User file will overwrite and erase the existing data, including all 10 User Songs, Style data loaded to the Style numbers 219–223, and all the Registration Memory settings. Save important data you want to keep to a separate USB Flash Drive before loading a User file.

- 1 Hold the [FUNCTION] button for longer than a second to call up the File Control display.
- 2 Use the CATEGORY [+] and [-] buttons to call up “Load USR.”



- 3 Press the [0/EXECUTE] button. “USER***” (***: number) appears on the display as the User file name in the USB Flash Drive. As desired, rotate the dial to select a different User file.



Note that the User file should be saved in the USERFILES folder on the USB Flash Drive. Files saved outside this folder cannot be recognized.

- 4 Press the [0/EXECUTE] button again. A confirmation message will appear. To cancel the operation, press the [-/NO] button.
- 5 Press the [0/EXECUTE] button again, or the [+ /YES] button to execute the Load operation. After a while, a message indicating completion of the operation appears.

NOTICE

- The Load operation cannot be cancelled during execution. Never turn off the power or disconnect the USB Flash Drive during the operation. Doing so may result in data loss.

- 6 Press the [FUNCTION] button to exit from the File Control display.
- 7 Check the loaded data by calling up the User Song, one of the Styles 219–223, and Registration Memory settings.

Loading a Style File

Style data created on another instrument or a computer can be loaded to the Style numbers 219–223, and you can play them like the internal preset Styles. The following two Load operations are available.

- Loading of a Style file (.sty) saved on the root directory on the USB Flash Drive
- Loading of a Style file (.sty) transferred from a computer via the Musicsoft Downloader and stored in the internal memory of this instrument

NOTE

- For instructions on transferring a Style file from a computer via the Musicsoft Downloader, refer to “Computer-related Operations” (page 9). After data transfer, load the Style data to one of the Style numbers 219–223 to enable playback.

NOTICE

- Loading a Style file will overwrite and erase the existing data of the destination number. Save important data you want to keep to a separate USB Flash Drive before loading.

- 1 Hold the [FUNCTION] button for longer than a second to call up the File Control display.
- 2 Use the CATEGORY [+] and [-] buttons to call up “Load STY.”



- 3 Press the [0/EXECUTE] button. A name of a Style file in the USB Flash Drive or internal memory of this instrument will appear on the display. As desired, rotate the dial to select a different Style file.



- 4 Press the [0/EXECUTE] button again. As the Load destination, “Load To? ***” (***) (219–223) appears on the display. If desired, rotate the dial to select a different number.



- 5 Press the [0/EXECUTE] button again. A confirmation message will appear. To cancel the operation, press the [-/NO] button.

- 6 Press the [0/EXECUTE] button again, or the [+ /YES] button to execute the Load operation. After a while, a message indicating completion of the operation appears.

NOTICE

- The Load operation cannot be cancelled during execution. Never turn off the power or disconnect the USB Flash Drive during the operation. Doing so may result in data loss.

- 7 Press the [STYLE] button, rotate the dial to select a Style from 219–223, then try playing it back.

Deleting a User File in the USB Flash Drive

User Files (.usr) in the root directory of the USB Flash Drive can be deleted.

IMPORTANT

- The User file (.usr) to be deleted should have been saved in the root directory of the USB Flash Drive. Files outside this folder cannot be recognized.

- 1 Hold the [FUNCTION] button for longer than a second to call up the File Control display.
- 2 Use the CATEGORY [+] and [-] buttons to call up “Del USR.”



- 3 Press the [0/EXECUTE] button. As a User file name in the USB Flash Drive, “USER****” (****: number) appears on the display. As desired, rotate the dial to select a different User file.



- 4 Press the [0/EXECUTE] button again. A confirmation message will appear. To cancel the operation, press the [-/NO] button.
- 5 Press the [0/EXECUTE] button again, or the [+ /YES] button to execute the Delete operation. After a while, a message indicating completion of the operation appears.

NOTICE

- The Delete operation cannot be cancelled during execution. Never turn off the power or disconnect the USB Flash Drive during the operation. Doing so may result in data loss.

- 6 Press the [FUNCTION] button to exit from the File Control display.

Deleting a SMF File in the USB Flash Drive

You can delete a SMF file that has been saved in the USB Flash Drive via the Save SMF operation (page 55).

IMPORTANT

- Only SMF files (.mid) saved in the “USER FILES” folder on the USB Flash Drive can be deleted. Files outside this folder cannot be recognized. This operation applies only to file names having the format “SONG****” (****: 001–100).

- 1 Hold the [FUNCTION] button for longer than a second to call up the File Control display.
- 2 Use the CATEGORY [+] and [-] buttons to call up “Del SMF.”



- 3 Press the [0/EXECUTE] button. As a SMF file name in the USB Flash Drive, “SONG****” (****: number) appears on the display. As desired, rotate the dial to select a different SMF file.



- 4 Press the [0/EXECUTE] button again. A confirmation message will appear. To cancel the operation, press the [-/NO] button.
- 5 Press the [0/EXECUTE] button again, or the [+ /YES] button to execute the Delete operation. After a while, a message indicating completion of the operation appears.

NOTICE

- The Delete operation cannot be cancelled during execution. Never turn off the power or disconnect the USB Flash Drive during the operation. Doing so may result in data loss.

- 6 Press the [FUNCTION] button to exit from the File Control display.

Exiting from a File Control display

To exit from the File Control display, press the [VOICE], [STYLE], [RIYAZ], [SONG], [FUNCTION], or [HARMONIUM/PIANO] button. You can also exit from the File Control function mode as follows:

- 1 Use the CATEGORY [+] and [-] buttons to call up “Exit?.”

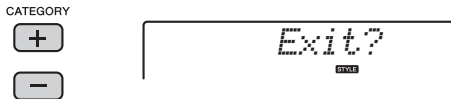

- 2 Press the [0/EXECUTE] button to exit from the File Control display.

Message	Comment
Can't Use	Indicates that the file control function is currently unavailable since the media is being accessed.
Comple.	Indicates the specified job completion such as data saving and transmission.
Data Err	Displayed when the user Song contains illegal data.
Disk Ful	Displayed when saving data cannot be executed since the media memory becomes full.
Error	Displayed when a file error or operational error occurs.
File Ful	Indicates that SMF Songs cannot be displayed since the total number of files exceeds the capacity.
no data	There is no data to save in the flash memory.
no file	There is no file to load or delete from the media.
	Communication with the USB device has been shut down because of the overcurrent to the USB device. Disconnect the device from the [USB TO DEVICE] terminal, then turn on the power of the instrument.
Protect	Displayed when trying to save or delete data on a protected media, or format a protected media. Set protect to off and try again.
UnFormat	Displayed when connecting an unformatted media.
UseAdpt	USB Flash Drive save, delete, and format operations cannot be performed when the instrument is being powered from battery. Use an AC adaptor.

Troubleshooting

Problem	Possible Cause and Solution
When the instrument is turned on or off, a popping sound is temporarily produced.	This is normal and indicates that the instrument is receiving electrical power.
When using a mobile phone, noise is produced	Using a mobile phone in close proximity to the instrument may produce interference. To prevent this, turn off the mobile phone or use it further away from the instrument
The instrument is automatically turned off even if no operation is done.	This is normal. This occurs due to the Auto Power Off function (page 14).
The volume is too soft. The sound quality is poor. The Style/Riyaz/Song/Arpeggio stops unexpectedly or will not play. The recorded data of the Song, etc. does not play correctly. The LCD display suddenly goes dark, and all panel settings are reset.	The batteries are low or dead. Replace all six batteries with completely new ones or completely recharged ones, or use the AC adaptor.
No sound is produced even when the keyboard is played, or a Song, Style, or Riyaz is being played back.	Check whether a set of headphones or an audio cable is connected to the [PHONES/OUTPUT], or not. When such a connection is made, no sound is output from the speaker of this instrument.
	Check the on/off status of the Local Control (page 49). Normally, set this parameter to ON.
The footswitch (for sustain) seems to produce the opposite effect. For example, pressing the footswitch cuts off the sound and releasing it sustains the sounds.	The polarity of the footswitch is reversed. Make sure that the footswitch plug is properly connected to the [SUSTAIN] jack before turning on the power.
No sound is produced even when playing keys in the right hand area of the keyboard, although chords played in the left hand area are recognized.	Check whether or not the Dictionary function (page 45) is used. When used, this is normal.
Not all of the Voices seem to sound, or the sound seems to be cut off, when playing the keyboard, Arpeggio, Style or Riyaz or Song.	You have exceeded 32 simultaneous notes, which is the maximum polyphony (the maximum amount of notes that can be played simultaneously) of this instrument. If the Main, Dual, and Split Voices are being used along with playback of Arpeggio, Style, Riyaz or Song, some notes/sounds may be omitted (or "stolen").
The sound of the Voice changes from note to note.	This is normal. The tone generation method uses multiple recordings (samples) of an instrument across the range of the keyboard; thus, the actual sound of the Voice may be slightly different from note to note.
The keyboard performance and playback of Style/Riyaz/Song produces an unexpected or inappropriate sound, and cannot be restored to the normal status.	Using the LIVE CONTROL Knobs can produce dramatic changes in the sound, but may also produce unexpected or undesired sounds. If you want to restore the original, normal sound before being changed by the LIVE CONTROL Knobs, change the Voice, Style, Riyaz or Song, or press the [HARMONIUM/PIANO] button to reset the panel settings.
The Style, Riyaz or Song does not start even when the [START/STOP] button is pressed. The Arpeggio does not start even when the note is pressed with the Arpeggio turned on.	Check the on/off status of the External Clock (page 49). Normally, set this parameter to OFF.
The volume of the Style, Riyaz or Song is too low.	Check the volume setting in the Functions (pages 42 and 47).
The chords played in the left hand area cannot be recognized even when the ACMP is turned on.	Check the Split Point setting (page 43). Set this to the appropriate value.
Style parts other than the Rhythm part produce no sound.	Check the on/off status of the ACMP (page 22). Make sure to turn ACMP on.
The ACMP indicator does not appear on the display when the [ACMP ON/OFF] button is pressed.	Check the on/off status of the [STYLE] lamp. When using a Style, press the [STYLE] button to turn on the [STYLE] lamp.

Specifications

Size/Weight	Dimensions (W x D x H)		946 mm x 405 mm x 140 mm (37-1/4" x 15-15/16" x 5-1/2")	
	Weight		6.8 kg (15lbs 0oz.) (not including batteries)	
Keyboard	Number of Keys		61	
	Touch Response		Soft/Medium/Hard/Off	
Other Controllers	Pitch Bend		Yes	
	Control Knobs		Yes	
Display	Display		LCD display	
	Language		English	
Voices	Tone Generation	Tone Generating Technology	AWM Stereo Sampling	
	Polyphony	Number of Polyphony (Max.)	32	
	Preset	Number of Voices	225 + 466XGlite + 6 Indian Kits + 21 Drum/SFX Kits + 46 Arpeggio	
	Compatibility		GM, XGlite	
Effects	Types	Reverb	9 types	
		Chorus	4 types	
		Master EQ	6 types	
		Harmony	26 types	
		Ultra-Wide Stereo	3 types	
	Functions	Dual	Yes	
Split		Yes		
Arpeggio type		162 types		
Accompaniment Styles	Preset	Number of Preset Styles	218	
		Fingering	Multi Finger	
		Style Control	ACMP ON/OFF, INTRO/ENDING/rit., MAIN/AUTO FILL, SYNC START, SYNC STOP, START/STOP, TRACK ON/OFF	
	User Styles		5	
Other Features	Music Database	355		
	One Touch Setting (OTS)	Yes		
Riyaz pattern	Preset	Number of Riyaz Patterns	20	
		Number of Sections (Max.)	5	
Songs (MIDI)	Preset	Number of Preset Songs	115	
		Number of Songs	10	
	Recording	Number of Tracks	6 (5 Melody + 1 Style)	
		Data Capacity	Approx. 19,000 notes (when only "melody" tracks are recorded)	
Compatible Data Format	Playback	SMF (Formats 0 & 1)		
	Recording	Original File Format (SMF 0 conversion function)		
Function	Lesson/Guide		[1 LISTENING, 2 TIMING, 3 WAITING], [Repeat & Learn], [Chord Dictionary]	
	Registration	Number of Buttons	4 (x 8 banks) with Freeze function	
	Overall	Metronome	Yes	
		Tempo Range	11 – 280	
		Transpose	-12 to 0, 0 to +12	
		Tuning	427.0 – 440.0 – 453.0 Hz (approx. 0.2Hz increments)	
	Miscellaneous	HARMONIUM/PIANO Button	Yes	
Memory/Connectivity	Memory	Internal Memory	Approx. 1.54MB	
		External Storage Device	USB Flash Drive	
	Connectivity	DC IN	DC IN 12V	
		Headphones/Output	[PHONES/OUTPUT] x 1	
		Sustain Pedal	[SUSTAIN] x 1	
		USB TO DEVICE	Yes	
USB TO HOST	Yes			
Amplifiers/Speakers	Amplifiers	2.5W + 2.5W		
	Speakers	12cm x 2		
Power Supply	Power Supply	Adaptor	PA-150B or an equivalent recommended by Yamaha	
		Batteries	Six "AA" size alkaline (LR6), manganese (R6) or Ni-MH rechargeable batteries	
	Power Consumption		• 16W (PA-150B)	
	Auto Power Off Function		Yes	
Accessories	Included Accessories	<ul style="list-style-type: none"> • Owner's Manual • AC Adaptor PA-150B or an equivalent • Music Rest • Online Member Product Registration 		
	Separately Sold Accessories	<ul style="list-style-type: none"> • AC Adaptor PA-150B or an equivalent recommended by Yamaha • Keyboard Stand (L-2C) • Stereo Headphones (HPH-50/HPH-100/HPH-150) • Footswitch (FC4A/FC5) 		

* The contents of this manual apply to the latest specifications as of the publishing date. To obtain the latest manual, access the Yamaha website then download the manual file. Since specifications, equipment or separately sold accessories may not be the same in every locale, please check with your Yamaha dealer.

A		E		L
AC Adaptor	9, 12	EFFECT	37, 38	Lesson
Accessories	9	EG (Envelope Generator)	37, 38	Lesson Track
ACMP	22, 40	ENDING	40	Listen
Arpeggio	20, 39	EQ Setting	35	LIVE CONTROL Knob
Arpeggio Quantize	39, 49	EQ Type	35	LIVE CONTROL Knob
Arpeggio Type	20, 49	Error	59	assignment
Arpeggio Velocity	49	Excellent	27	Load STY
ATTACK	37	Exit?	59	Load USR
Attack Time	37, 48, 49	External Clock	49	Local Control
Auto Accompaniment	40			
Auto Accompaniment range	22	F		M
AUTO FILL	40	Fast Forward	25	MAIN
Auto Power Off	14	Fast Reverse	25	Main
Auto Power Off Time	50	File Control	59	Main Voice
		File Ful	59	Master EQ Type
		FILTER	37, 38	MASTER VOLUME
		Filter	21	MEASURE
B		Filter Cutoff	21, 49	Melody Voice
Backup	32	Filter Resonance	21, 49	Metronome
Backup Clear	32	Flash Clear	32	Volume
Backup Parameters	32	Footswitch	13, 39	MIDI Basics
Battery	12	Format	53	MIDI Reference
Battery Type	13, 50	Freeze Mode	31, 32, 50	Mridangam
Beat	15	Function	48	Music Database
BGM Playback	46	Function List	48	Music Rest
		G		N
C		GM System Level 1	8	no data
Can't Use	59	Grade	27	no file
Chord	15, 43			Notation
Chord Dictionary	45	H		
CHORUS	37	Harmony	19	O
Chorus Depth	33, 48, 49	Harmony Type	19, 49	Octave
Chorus Type	33, 49	Harmony Volume	49	OK
Complet.	59	Headphone	13	One Touch Setting (OTS)
Computer-related Operations	9			
CUTOFF	37			
		I		P
D		Initial Send	50	Pan
Data Err	59	Initialization	32	Pause
Del SMF	58	INTRO	40	Pedal Function
Del USR	58			PITCH BEND
Demo Cancel	32, 50	K		Range
Demo Group	32, 50	Keyboard Out	50	Pitch Controls
Demo Play Mode	50			Power
Demo Song	24			Power Requirements
Disk Ful	59			Power source
Display	15			Preset Song
Dual Voice	17, 36, 49			Protect

R	
Raga Scale	24
Random	46
Recording	28
Registration Memory	31
RELEASE	38
Release Time	38, 49
Repeat	25
Repeat & Learn	27
RESONANCE	37
REVERB	37
Reverb Depth	33, 48, 49
Reverb Type	33, 49
Riyaz	23, 37
S	
Save SMF	55
Save USR	54
Section	40
SMF (Standard MIDI File)	55
Song	24
Song Book	9
Song Category	24
Song Out	50
Song Volume	32, 47, 48
Sostenuto	13, 50
Split Point	43, 48
Split Voice	17, 36, 49
Style	22, 40
STYLE FILE	8
Style File	57
STYLE FILTER	38
Style Out	50
Style Volume	42, 48
Sustain	39
SYNC START	22
Synchro Start	40
Synchro Stop	41
T	
Tabla	23
Tanpura	23
Tap Start	42
Tempo	18, 42
Time Signature	18, 50
Timing	26
Touch Sensitivity	35, 48
Track	28
TRACK CONTROL	41
Track On/Off	25
Transpose	34, 48
Troubleshooting	60
Tuning	34, 48
U	
UnFormat	59
USB	8
USB Flash Drive	51
USB TO DEVICE	51
USB TO HOST	11
UseAdpt	59
User Song	28
V	
Variation	23, 42
Very Good	27
Volume	48, 49
Volume of the Riyaz	42
Volume of the Style	42
W	
Waiting	26
Wide Type	49
X	
XGlite	8
Y	
Your Tempo	50

NORTH AMERICA

CANADA

Yamaha Canada Music Ltd.
135 Milner Avenue, Toronto, Ontario M1S 3R1,
Canada
Tel: +1-416-298-1311

U.S.A.

Yamaha Corporation of America
6600 Orangethorpe Avenue, Buena Park, CA 90620,
U.S.A.
Tel: +1-714-522-9011

CENTRAL & SOUTH AMERICA

MEXICO

Yamaha de México, S.A. de C.V.
Av. Insurgentes Sur 1647 Piso 9, Col. San José
Insurgentes, Delegación Benito Juárez, México,
D.F., C.P. 03900, México
Tel: +52-55-5804-0600

BRAZIL

Yamaha Musical do Brasil Ltda.
Rua Filadelfo Ramos, 302 – Cj 52 e 54 – Torre B –
Vila Olímpia – CEP 04551-010 – São Paulo/SP,
Brazil
Tel: +55-11-3704-1377

ARGENTINA

**Yamaha Music Latin America, S.A.,
Sucursal Argentina**
Olga Cossetini 1553, Piso 4 Norte,
Madero Este-C1107CEK,
Buenos Aires, Argentina
Tel: +54-11-4119-7000

**PANAMA AND OTHER LATIN
AMERICAN COUNTRIES/
CARIBBEAN COUNTRIES**

Yamaha Music Latin America, S.A.
Edificio Torre Davivienda, Piso: 20
Avenida Balboa, Marbella, Corregimiento de Bella
Vista, Ciudad de Panamá, Rep. de Panamá
Tel: +507-269-5311

EUROPE

THE UNITED KINGDOM/IRELAND

Yamaha Music Europe GmbH (UK)
Sherbourne Drive, Tilbrook, Milton Keynes,
MK7 8BL, U.K.
Tel: +44-1908-366700

GERMANY

Yamaha Music Europe GmbH
Siemensstrasse 22-34, 25462 Rellingen, Germany
Tel: +49-4101-303-0

SWITZERLAND/LIECHTENSTEIN

**Yamaha Music Europe GmbH, Branch
Switzerland in Thalwil**
Seestrasse 18a, 8800 Thalwil, Switzerland
Tel: +41-44-3878080

**AUSTRIA/CROATIA/CZECH REPUBLIC/
HUNGARY/ROMANIA/SLOVAKIA/
SLOVENIA**

Yamaha Music Europe GmbH, Branch Austria
Schleiergasse 20, 1100 Wien, Austria
Tel: +43-1-60203900

POLAND

**Yamaha Music Europe GmbH
Sp.z o.o. Oddział w Polsce**
ul. Wielicka 52, 02-657 Warszawa, Poland
Tel: +48-22-880-08-88

BULGARIA

Dinacord Bulgaria LTD.
Bul. Iskarsko Schose 7 Targowski Zentar Ewropa
1528 Sofia, Bulgaria
Tel: +359-2-978-20-25

MALTA

Olimpus Music Ltd.
Valletta Road, Mosta MST9010, Malta
Tel: +356-2133-2093

**NETHERLANDS/BELGIUM/
LUXEMBOURG**

Yamaha Music Europe, Branch Benelux
Clarissenhof 5b, 4133 AB Vianen, The Netherlands
Tel: +31-347-358040

FRANCE

Yamaha Music Europe
7 rue Ambroise Croizat, Zone d'activités de Pariest,
77183 Croissy-Beaubourg, France
Tel: +33-1-6461-4000

ITALY

Yamaha Music Europe GmbH, Branch Italy
Via Tinelli N.67/69 20855 Gerno di Lesmo (MB),
Italy
Tel: +39-039-9065-1

SPAIN/PORTUGAL

**Yamaha Music Europe GmbH Ibérica, Sucursal
en España**
Ctra. de la Coruña km. 17,200, 28231
Las Rozas de Madrid, Spain
Tel: +34-91-639-88-88

GREECE

Philippos Nakas S.A. The Music House
19th km. Leof. Lavriou 190 02 Peania – Attiki,
Greece
Tel: +30-210-6686260

SWEDEN

**Yamaha Music Europe GmbH Germany filial
Scandinavia**
JA Wettergrensgata 1, 400 43 Göteborg, Sweden
Tel: +46-31-89-34-00

DENMARK

**Yamaha Music Denmark,
Fillial of Yamaha Music Europe GmbH, Tyskland**
Generatorvej 8C, ST. TH., 2860 Søborg, Denmark
Tel: +45-44-92-49-00

FINLAND

F-Musiikki Oy
Antaksentie 4
FI-01510 Vantaa, Finland
Tel: +358 (0)96185111

NORWAY

**Yamaha Music Europe GmbH Germany -
Norwegian Branch**
Grini Næringspark 1, 1332 Østerås, Norway
Tel: +47-6716-7800

ICELAND

Hjodfaerahusid Ehf.
Sidumula 20
IS-108 Reykjavik, Iceland
Tel: +354-525-5050

CYPRUS

Nakas Music Cyprus Ltd.
Nikis Ave 2k
1086 Nicosia
Tel: +357-22-511080
Major Music Center
21 Ali Riza Ave. Ortakoy
P.O.Box 475 Lefkoşa, Cyprus
Tel: (392) 227 9213

RUSSIA

Yamaha Music (Russia) LLC.
Room 37, entrance 7, bld. 7, Kievskaya street,
Moscow, 121059, Russia
Tel: +7-495-626-5005

OTHER EUROPEAN COUNTRIES

Yamaha Music Europe GmbH
Siemensstrasse 22-34, 25462 Rellingen, Germany
Tel: +49-4101-303-0

AFRICA

Yamaha Music Gulf FZE
JAFZA-16, Office 512, P.O.Box 17328,
Jebel Ali FZE, Dubai, UAE
Tel: +971-4-801-1500

MIDDLE EAST

TURKEY

Yamaha Music Europe GmbH
Merkezi Almanya Türkiye Istanbul Şubesi
Mor Sumbul Sokak Varyap Meridian Business
1.Blok No:1 113-114-115
Bati Atasehir Istanbul, Turkey
Tel: +90-216-275-7960

ISRAEL

RBX International Co., Ltd.
P.O Box 10245, Petach-Tikva, 49002
Tel: (972) 3-925-6900

OTHER COUNTRIES

Yamaha Music Gulf FZE
JAFZA-16, Office 512, P.O.Box 17328,
Jebel Ali FZE, Dubai, UAE
Tel: +971-4-801-1500

ASIA

THE PEOPLE'S REPUBLIC OF CHINA

Yamaha Music & Electronics (China) Co., Ltd.
2F, Yunhedasha, 1818 Xinzha-lu, Jingan-qu,
Shanghai, China
Tel: +86-400-051-7700

HONG KONG

Tom Lee Music Co., Ltd.
11/F., Silvercord Tower 1, 30 Canton Road,
Tsimshatsui, Kowloon, Hong Kong
Tel: +852-2737-7688

INDIA

Yamaha Music India Private Limited
P-401, JMD Megapolis, Sector-48, Sohna Road,
Gurugram-122018, Haryana, India
Tel: +91-124-485-3300

INDONESIA

PT. Yamaha Musik Indonesia (Distributor)
Yamaha Music Center Bldg. Jalan Jend. Gatot
Subroto Kav. 4, Jakarta 12930, Indonesia
Tel: +62-21-520-2577

KOREA

Yamaha Music Korea Ltd.
11F, Prudential Tower, 298, Gangnam-daero,
Gangnam-gu, Seoul, 06253, Korea
Tel: +82-2-3467-3300

MALAYSIA

Yamaha Music (Malaysia) Sdn. Bhd.
No.8, Jalan Perbandaran, Kelana Jaya, 47301
Petaling Jaya, Selangor, Malaysia
Tel: +60-3-78030900

SINGAPORE

Yamaha Music (Asia) Private Limited
Block 202 Hougang Street 21, #02-00,
Singapore 530202, Singapore
Tel: +65-6740-9200

TAIWAN

Yamaha Music & Electronics Taiwan Co., Ltd.
2F., No.1, Yuanandong Rd., Banqiao Dist.,
New Taipei City 22063, Taiwan (R.O.C.)
Tel: +886-2-7741-8888

THAILAND

Siam Music Yamaha Co., Ltd.
3, 4, 15, 16th Fl., Siam Motors Building,
891/1 Rama 1 Road, Wangmai,
Pathumwan, Bangkok 10330, Thailand
Tel: +66-2215-2622

VIETNAM

Yamaha Music Vietnam Company Limited
15th Floor, Nam A Bank Tower, 201-203 Cach
Mang Thang Tam St., Ward 4, Dist.3,
Ho Chi Minh City, Vietnam
Tel: +84-28-3818-1122

OTHER ASIAN COUNTRIES

[https://asia-latinamerica-mea.yamaha.com/
index.html](https://asia-latinamerica-mea.yamaha.com/index.html)

OCEANIA

AUSTRALIA

Yamaha Music Australia Pty. Ltd.
Level 1, 80 Market Street, South Melbourne,
VIC 3205 Australia
Tel: +61-3-9693-5111

NEW ZEALAND

Music Works LTD
P.O.BOX 6246 Wellesley, Auckland 4680,
New Zealand
Tel: +64-9-634-0099

**COUNTRIES AND TRUST
TERRITORIES IN PACIFIC OCEAN**

[https://asia-latinamerica-mea.yamaha.com/
index.html](https://asia-latinamerica-mea.yamaha.com/index.html)