

MUSIC SYNTHESIZER

MM6 MM8

Owner's Manual

SPECIAL MESSAGE SECTION

This product utilizes batteries or an external power supply (adapter). DO NOT connect this product to any power supply or adapter other than one described in the manual, on the name plate, or specifically recommended by Yamaha.

This product should be used only with the components supplied or; a cart, rack, or stand that is recommended by Yamaha. If a cart, etc., is used, please observe all safety markings and instructions that accompany the accessory product.

SPECIFICATIONS SUBJECT TO CHANGE:

The information contained in this manual is believed to be correct at the time of printing. However, Yamaha reserves the right to change or modify any of the specifications without notice or obligation to update existing units.

This product, either alone or in combination with an amplifier and headphones or speaker/s, may be capable of producing sound levels that could cause permanent hearing loss. DO NOT operate for long periods of time at a high volume level or at a level that is uncomfortable. If you experience any hearing loss or ringing in the ears, you should consult an audiologist.

IMPORTANT: The louder the sound, the shorter the time period before damage occurs.

NOTICE:

Service charges incurred due to a lack of knowledge relating to how a function or effect works (when the unit is operating as designed) are not covered by the manufacturer's warranty, and are therefore the owners responsibility. Please study this manual carefully and consult your dealer before requesting service.

ENVIRONMENTAL ISSUES:

Yamaha strives to produce products that are both user safe and environmentally friendly. We sincerely believe that our products and the production methods used to produce them, meet these goals. In keeping with both the letter and the spirit of the law, we want you to be aware of the following:

Battery Notice:

This product MAY contain a small non-rechargeable battery which (if applicable) is soldered in place. The average life span of this type of battery is approximately five years. When replacement becomes necessary, contact a qualified service representative to perform the replacement.

This product may also use "household" type batteries. Some of these may be rechargeable. Make sure that the battery being charged is a rechargeable type and that the charger is intended for the battery being charged.

When installing batteries, do not mix batteries with new, or with batteries of a different type. Batteries MUST be installed correctly. Mismatches or incorrect installation may result in overheating and battery case rupture.

Warning:

Do not attempt to disassemble, or incinerate any battery. Keep all batteries away from children. Dispose of used batteries promptly and as regulated by the laws in your area. Note: Check with any retailer of household type batteries in your area for battery disposal information.

Disposal Notice:

Should this product become damaged beyond repair, or for some reason its useful life is considered to be at an end, please observe all local, state, and federal regulations that relate to the disposal of products that contain lead, batteries, plastics, etc. If your dealer is unable to assist you, please contact Yamaha directly.

NAME PLATE LOCATION:

The name plate is located on the bottom of the product. The model number, serial number, power requirements, etc., are located on this plate. You should record the model number, serial number, and the date of purchase in the spaces provided below and retain this manual as a permanent record of your purchase.

Model

Serial No.

Purchase Date

PLEASE KEEP THIS MANUAL

92-BP (bottom)

FCC INFORMATION (U.S.A.)

1. IMPORTANT NOTICE: DO NOT MODIFY THIS UNIT!

This product, when installed as indicated in the instructions contained in this manual, meets FCC requirements. Modifications not expressly approved by Yamaha may void your authority, granted by the FCC, to use the product.

2. IMPORTANT:

When connecting this product to accessories and/or another product use only high quality shielded cables. Cable/s supplied with this product MUST be used. Follow all installation instructions. Failure to follow instructions could void your FCC authorization to use this product in the USA.

3. NOTE:

This product has been tested and found to comply with the requirements listed in FCC Regulations, Part 15 for Class "B" digital devices. Compliance with these requirements provides a reasonable level of assurance that your use of this product in a residential environment will not result in harmful interference with other electronic devices. This equipment generates/uses radio frequencies and, if not installed and used according to the instructions found in the users manual, may cause interference harmful to the operation of other electronic devices. Compliance with FCC regulations does

not guarantee that interference will not occur in all installations. If this product is found to be the source of interference, which can be determined by turning the unit "OFF" and "ON", please try to eliminate the problem by using one of the following measures:

Relocate either this product or the device that is being affected by the interference.

Utilize power outlets that are on different branch (circuit breaker or fuse) circuits or install AC line filter/s.

In the case of radio or TV interference, relocate/reorient the antenna. If the antenna lead-in is 300 ohm ribbon lead, change the lead-in to co-axial type cable.

If these corrective measures do not produce satisfactory results, please contact the local retailer authorized to distribute this type of product. If you can not locate the appropriate retailer, please contact Yamaha Corporation of America, Electronic Service Division, 6600 Orangethorpe Ave, Buena Park, CA90620

The above statements apply ONLY to those products distributed by Yamaha Corporation of America or its subsidiaries.

* This applies only to products distributed by YAMAHA CORPORATION OF AMERICA.

(class B)

OBSERVERA!

Apparaten kopplas inte ur växelströmskällan (nätet) så länge som den är ansluten till vägguttaget, även om själva apparaten har stängts av.

ADVARSEL: Netspændingen til dette apparat er IKKE afbrudt, så længe netledningen sidder i en stikkontakt, som er tændt — også selvom der er slukket på apparatets afbryder.

VAROITUS: Laitteen toisiopiiriin kytketty käyttökyltkin ei irroita koko laitetta verkosta.

(standby)

This product contains a high intensity lamp that contains a small amount of mercury. Disposal of this material may be regulated due to environmental considerations. For disposal information in the United States, refer to the Electronic Industries Alliance web site: www.eiae.org

* This applies only to products distributed by YAMAHA CORPORATION OF AMERICA.

(mercury)

COMPLIANCE INFORMATION STATEMENT (DECLARATION OF CONFORMITY PROCEDURE)

Responsible Party : Yamaha Corporation of America

Address : 6600 Orangethorpe Ave., Buena Park, Calif.
90620

Telephone : 714-522-9011

Type of Equipment : Music Synthesizer

Model Name : MM6, MM8

This device complies with Part 15 of the FCC Rules.

Operation is subject to the following two conditions:

- 1) this device may not cause harmful interference, and
- 2) this device must accept any interference received including interference that may cause undesired operation.

See user manual instructions if interference to radio reception is suspected.

* This applies only to products distributed by YAMAHA CORPORATION OF AMERICA.

(FCC DoC)

IMPORTANT NOTICE FOR THE UNITED KINGDOM Connecting the Plug and Cord

IMPORTANT. The wires in this mains lead are coloured in accordance with the following code:

BLUE : NEUTRAL
BROWN : LIVE

As the colours of the wires in the mains lead of this apparatus may not correspond with the coloured markings identifying the terminals in your plug proceed as follows:

The wire which is coloured BLUE must be connected to the terminal which is marked with the letter N or coloured BLACK.

The wire which is coloured BROWN must be connected to the terminal which is marked with the letter L or coloured RED.

Making sure that neither core is connected to the earth terminal of the three pin plug.

• This applies only to products distributed by Yamaha Music U.K. Ltd. (2 wires)

PRECAUTIONS

PLEASE READ CAREFULLY BEFORE PROCEEDING

* Please keep this manual in a safe place for future reference.



WARNING

Always follow the basic precautions listed below to avoid the possibility of serious injury or even death from electrical shock, short-circuiting, damages, fire or other hazards. These precautions include, but are not limited to, the following:

Power supply/AC power adaptor

- Only use the voltage specified as correct for the instrument. The required voltage is printed on the name plate of the instrument.
- Use the specified adaptor (PA-5D, PA-150 or an equivalent recommended by Yamaha) only. Using the wrong adaptor can result in damage to the instrument or overheating.
- Check the electric plug periodically and remove any dirt or dust which may have accumulated on it.
- Do not place the AC adaptor cord near heat sources such as heaters or radiators, and do not excessively bend or otherwise damage the cord, place heavy objects on it, or place it in a position where anyone could walk on, trip over, or roll anything over it.

Do not open

- Do not open the instrument or attempt to disassemble the internal parts or modify them in any way. The instrument contains no user-serviceable parts. If it should appear to be malfunctioning, discontinue use immediately and have it inspected by qualified Yamaha service personnel.

Water warning

- Do not expose the instrument to rain, use it near water or in damp or wet conditions, or place containers on it containing liquids which might spill into any openings. If any liquid such as water seeps into the instrument, turn off the power immediately and unplug the power cord from the AC outlet. Then have the instrument inspected by qualified Yamaha service personnel.
- Never insert or remove an electric plug with wet hands.

Fire warning

- Do not put burning items, such as candles, on the unit. A burning item may fall over and cause a fire.

If you notice any abnormality

- If the AC adaptor cord or plug becomes frayed or damaged, or if there is a sudden loss of sound during use of the instrument, or if any unusual smells or smoke should appear to be caused by it, immediately turn off the power switch, disconnect the adaptor plug from the outlet, and have the instrument inspected by qualified Yamaha service personnel.



CAUTION

Always follow the basic precautions listed below to avoid the possibility of physical injury to you or others, or damage to the instrument or other property. These precautions include, but are not limited to, the following:

Power supply/AC power adaptor

- When removing the electric plug from the instrument or an outlet, always hold the plug itself and not the cord.
- Unplug the AC power adaptor when not using the instrument, or during electrical storms.
- Do not connect the instrument to an electrical outlet using a multiple-connector. Doing so can result in lower sound quality, or possibly cause overheating in the outlet.

Location

- Do not expose the instrument to excessive dust or vibrations, or extreme cold or heat (such as in direct sunlight, near a heater, or in a car during the day) to prevent the possibility of panel disfiguration or damage to the internal components.
- Do not use the instrument in the vicinity of a TV, radio, stereo equipment, mobile phone, or other electric devices. Otherwise, the instrument, TV, or radio may generate noise.

- Do not place the instrument in an unstable position where it might accidentally fall over.
- Before moving the instrument, remove all connected adaptor and other cables.
- When setting up the product, make sure that the AC outlet you are using is easily accessible. If some trouble or malfunction occurs, immediately turn off the power switch and disconnect the plug from the outlet. Even when the power switch is turned off, electricity is still flowing to the product at the minimum level. When you are not using the product for a long time, make sure to unplug the power cord from the wall AC outlet.
- Use only the stand specified for the instrument. When attaching the stand or rack, use the provided screws only. Failure to do so could cause damage to the internal components or result in the instrument falling over.

Connections

- Before connecting the instrument to other electronic components, turn off the power for all components. Before turning the power on or off for all components, set all volume levels to minimum. Also, be sure to set the volumes of all components at their minimum levels and gradually raise the volume controls while playing the instrument to set the desired listening level.

Maintenance

- When cleaning the instrument, use a soft, dry cloth. Do not use paint thinners, solvents, cleaning fluids, or chemical-impregnated wiping cloths.

Handling caution

- Never insert or drop paper, metallic, or other objects into the gaps on the panel or keyboard. If this happens, turn off the power immediately and unplug the power cord from the AC outlet. Then have the instrument inspected by qualified Yamaha service personnel.
- Do not place vinyl, plastic or rubber objects on the instrument, since this might discolor the panel or keyboard.
- Do not rest your weight on, or place heavy objects on the instrument, and do not use excessive force on the buttons, switches or connectors.

- Do not use the instrument/device or headphones for a long period of time at a high or uncomfortable volume level, since this can cause permanent hearing loss. If you experience any hearing loss or ringing in the ears, consult a physician.

Saving data

Saving and backing up your data

- Saved data may be lost due to malfunction or incorrect operation. Save important data to a USB storage device/or other external device such as a computer. (pages 69, 76)

Backing up the USB storage device

- To protect against data loss through media damage, we recommend that you save your important data onto two USB storage devices or other external device such as a computer.

Yamaha cannot be held responsible for damage caused by improper use or modifications to the instrument, or data that is lost or destroyed.

Always turn the power off when the instrument is not in use.

Even when the power switch is in the "STANDBY" position, electricity is still flowing to the instrument at the minimum level. When you are not using the instrument for a long time, make sure you unplug the AC power adaptor from the wall AC outlet.

The illustrations and LCD screens as shown in this owner's manual are for instructional purposes only, and may appear somewhat different from those on your instrument.

● Trademarks

- Windows is the registered trademarks of Microsoft® Corporation.
- Apple and Macintosh are trademarks of Apple Inc., registered in the U.S and other countries.
- The company names and product names in this Owner's Manual are the trademarks or registered trademarks of their respective companies.

This product incorporates and bundles computer programs and contents in which Yamaha owns copyrights or with respect to which it has license to use others' copyrights. Such copyrighted materials include, without limitation, all computer software, style files, MIDI files, WAVE data, musical scores and sound recordings. Any unauthorized use of such programs and contents outside of personal use is not permitted under relevant laws. Any violation of copyright has legal consequences. **DON'T MAKE, DISTRIBUTE OR USE ILLEGAL COPIES.**

Copying of the commercially available musical data including but not limited to MIDI data and/or audio data is strictly prohibited except for your personal use.

***Congratulations, and thank you for your choosing the Yamaha MM6/
MM8 Music Synthesizer!***

***Please read this owner's manual carefully before using the instrument
in order to take full advantage of it's various features.***

***When you have finished reading the manual keep it in a safe, accessible
place, and refer to it when you need to better understand an operation
or function.***

Accessories

The instrument package includes the following items. Please check that you have them all.

- Owner's Manual
- Supplied Disk (supplied DAW software)
- AC Power Adaptor (May not be included depending on the region in which you purchased the product. Please check with your Yamaha dealer.)

Since the MM6 and MM8 have the same control layout and input/output configuration, the MM6 will be used for example illustrations throughout this manual.

Main Features

■ High-Quality Voices for Keyboard Performance ► Page 15

The MM6/MM8 contains a wide range of high-quality voices (many based on the Motif Series voices), ranging from acoustic musical instruments to unique synthesizer sounds. Use the Category Search function to quickly call up the sounds you want, based on their instrument type. The MM8 features an 88-key “Graded Hammer” keyboard with action that is virtually indistinguishable from an actual acoustic piano.

■ Play the Keyboard Along with a Pattern ► Page 23

The patterns in the MM6/MM8 were created to give you a wide range of different musical genres simply by playing back the pattern tracks. Moreover, you can easily record chord changes to both the patterns and your real time keyboard performance in the Song mode.

■ Use the Arpeggio ► Page 20

The versatile Arpeggio feature automatically plays drum percussion phrases, guitar phrases, and analog synthesizer style phrases in response to the keys you play.

■ Save and Switch Between Performance Settings (Performance Memory) ► Page 59

The Performance Memory lets you conveniently create and store combined settings for the voices you play (including keyboard splits and layers), the patterns you want to assign to backing tracks, and other important settings for live performance. These performance settings can be easily recalled by a single button press.

■ Controlling Filter and EG in Real Time ► Page 41

You can control the filter (cutoff and resonance) and EG (attack and release) in real time by using four knobs on the panel. Even these detailed sonic changes can be saved in the Performance Memory.

■ Save Performance Data to a USB Storage Device ► Page 66

Transferring data between the MM6/MM8 and your computer is easy because the MM6/MM8 can store data and setting to standard USB storage devices.

■ Create Music with Your Computer and the Bundled DAW Software ► Page 80

You can connect the MM6/MM8 to your computer using a USB cable, and transfer MIDI data to and from DAW software. With the Bundled DAW software the MM6/MM8 becomes the central tone generator for your computer based music production system.

Contents

Accessories	7
Main Features	8
Setting Up	10
Power Supply Connections	10
Cable clip.....	10
Using Headphones.....	10
Connecting to a Computer (USB Terminal).....	10
Turning the Power On	11
Adjust Volume and Display Contrast.....	11
Panel Controls and Terminals	12
Front Panel.....	12
Rear Panel	13

Quick Guide

Playing the Demo Song	14
Play the Instrument	15
Selecting the Main Voice	15
Combining Voices—Dual.....	16
Split the Keyboard.....	17
Selecting a Drum Voice.....	19
Using the Arpeggio Function	20
Playing Patterns	22
Listen to the Rhythm Pattern.....	22
Play Along with a Pattern	23
Playing Auto-accompaniment Chords	25
Using Songs	26
Selecting and Listening to a Song.....	26
Song Fast Forward, Fast Reverse, and Pause	27
Types of Songs	28
Recording Your Own Performance	29
Recording Procedure	30
Song Clear—Deleting User Songs.....	33
Track Clear—Deleting a Specified Track from a User Song ..	34

Backup and Initialization	35
Backup	35
Initialization.....	35

Basic Operation and Displays	36
Basic Operation.....	36
The Displays.....	38
MAIN Display Items	39

Reference

Using the Controllers	40
Controllers on the front panel.....	40
External Controllers.....	41
Enhancing the Sound with Reverb, Chorus, and DSP Effects	42
Selecting a Reverb type	42
Selecting a Chorus type	43
Applying DSP Effects	44
Handy Performance Features	45
Using the Metronome	45
Adjusting the Tempo	47
Using the TAP TEMPO Button	47
Setting the Touch Response	47
Select a Master EQ Setting for the Best Sound	48
Controlling Arpeggio Volume with Keyboard Dynamics	48
Transpose the Keyboard	49
Shifting Keyboard Pitch in Octaves	50

Pattern Functions	51
--------------------------------	-----------

Pattern Variations (Sections).....	51
Setting the Split Point	52
Play a Pattern with Chords but No Rhythm (Stop Accompaniment)	53
Pattern Volume Adjustment.....	53
Chord Basics	54
Specify Chords Over the Entire Keyboard Range	56

Song Settings	57
----------------------------	-----------

Song Volume	57
Change the Song Tempo	57
Track Mute.....	58

Memorize Your Favorite Panel Settings	59
--	-----------

Saving to the Performance Memory	59
Recalling Settings from the Performance Memory	60
Erase a Performance Memory.....	61

Voice Editing	62
----------------------------	-----------

Select and Edit an Item	62
Edit Display List	63

Utility Settings	64
-------------------------------	-----------

Selecting and Setting Functions	64
Utility Display List	65

Storing/Saving Data	66
----------------------------------	-----------

Using a USB Storage Device	67
Formatting a USB storage device.....	68
Saving Data	69
Convert a User Song to SMF Format and Save	70
Loading User Files and Pattern Files	71
Deleting Data from a USB Storage Device.....	72
Playing SMF Saved to a USB Storage Device	72

Connections	73
--------------------------	-----------

The Connectors	73
Connecting to External Audio Equipment.....	74
Connecting to External MIDI Devices	74
Connecting a USB Storage Device	75
Connecting to a Personal Computer	77
Transferring Performance Data to and from a Computer	78
Initial Setup.....	79

About the Supplied Disk	80
--------------------------------------	-----------

About the Supplied DAW Software.....	80
Support	80

Appendix

Troubleshooting.....	82
Messages	83
Voice List.....	84
Drum Kit List.....	90
Performance List	96
Pattern List	98
Master EQ List.....	99
Effect Type List.....	100
Arpeggio Type List.....	104
MIDI Implementation Chart.....	106
MIDI Data Format	108
Specifications	109
Index.....	110

Setting Up

Be sure to do the following **BEFORE** turning on the power.

Power Supply Connections

- 1 Make sure that the [STANDBY/ON] switch of the instrument is set to STANDBY.

⚠ **WARNING**

- Use the specified adaptor (PA-5D, PA-150, or an equivalent recommended by Yamaha) only. The use of other adaptors may result in irreparable damage to both the adaptor and the instrument.

- 2 Plug the adaptor's DC plug into the DC IN jack on the instrument's rear panel.
- 3 Plug the AC adaptor into a convenient AC wall outlet.

⚠ **CAUTION**

- Unplug the AC Power Adaptor when not using the instrument, or during electrical storms.

Cable clip

MM6

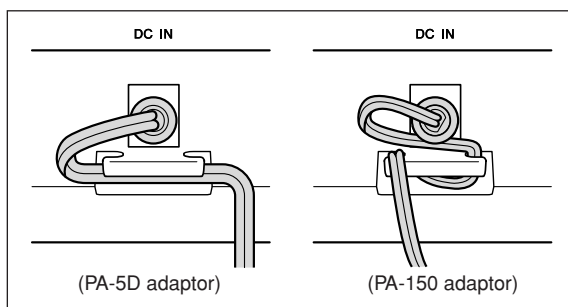

MM8

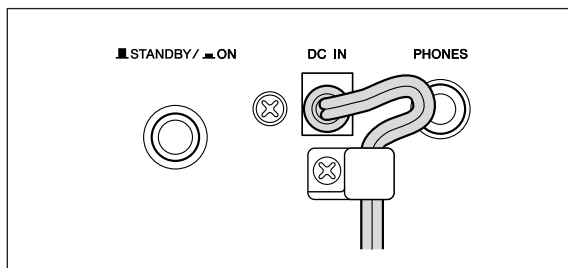

Wrap the DC output cable of the adaptor around the cable clip (as shown above) to prevent accidental unplugging of the cable during operation. Avoid tightening the cord more than necessary or pulling on the cord strongly while it is wrapped around the cable clip to prevent wear on the cord or possible breakage of the clip.

Make all necessary connections, as described below, **BEFORE** turning the power on.

Using Headphones

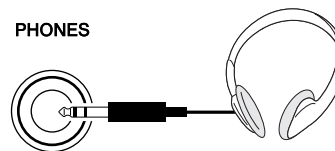

Since the MM6/MM8 has no built-in speakers, it must be connected to an external amplifier and speakers, headphones, or other sound output device.

⚠ **WARNING**

- Do not use headphones at a high volume for an extended period of time. Doing so may cause hearing loss.

⚠ **CAUTION**

- When connecting the instrument to external equipment make sure that the power to all external devices is turned off to prevent possible electrical shock or equipment damage. Also be sure to turn any volume controls on external equipment to minimum when making connections to prevent possible speaker damage.

Connecting to a Computer (USB Terminal)

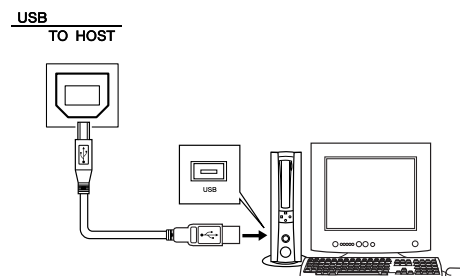

You can connect the instrument's USB terminal to the USB terminal of a computer to allow transfer of performance data and song files between the two (page 77). To use the USB data-transfer features you'll need to do the following:

- First, make sure the **POWER** switch on the MIDI device is set to **OFF**, then use a USB cable to connect the MIDI device to the computer.
- Install the **USB-MIDI Driver** on your computer.

You can download the proper USB-MIDI driver from our website:

http://www.global.yamaha.com/download/usb_midi/

Refer to the instructions included with the USB-MIDI Driver download package for the USB-MIDI Driver installation procedure.

NOTE

- USB cables can be purchased at some musical instrument stores, computer stores, and similar retail outlets.

Turning the Power On

Turn down the volume by turning the [MASTER VOLUME] control to the left and press the [STANDBY/ON] switch to turn on the power. Press the [STANDBY/ON] switch again to turn the power OFF.

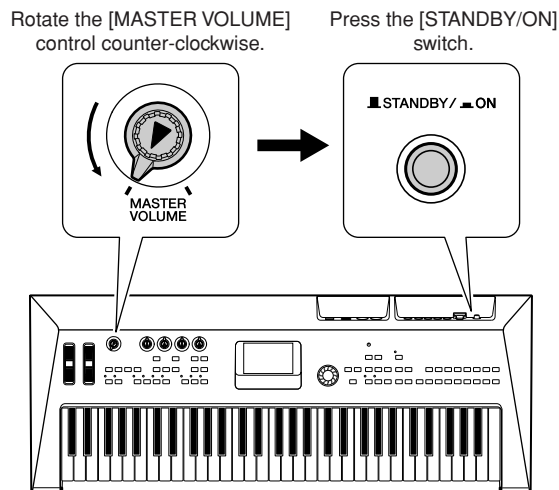

Backup data is loaded from the internal flash memory when the power is turned on. If no backup data exists in the flash memory, all instrument settings are restored to the initial factory defaults.

CAUTION

- Even when the switch is in the “STANDBY” position, a minute electrical current is present in the instrument. If you will not be using the instrument for an extended period of time, make sure you unplug the AC power adaptor from the wall AC outlet.

CAUTION

- Never attempt to turn the power off when a “Writing..” message is showing on the display. Doing so can damage the flash memory and result in a loss of data.

Adjust Volume and Display Contrast

Set the MM6/MM8 and external playback equipment volume controls to appropriate levels. If necessary, adjust the legibility of the LCD display by using the LCD Contrast Control.

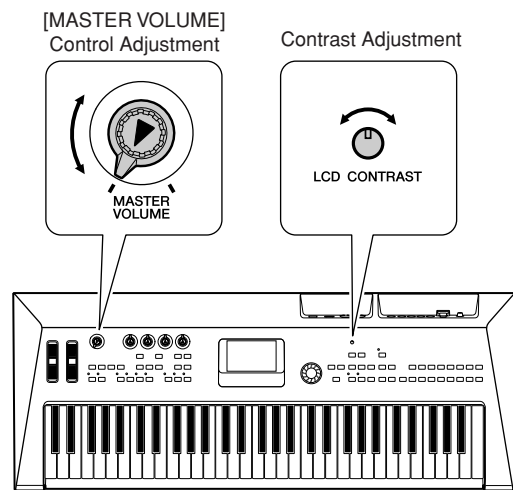

Panel Controls and Terminals

Front Panel

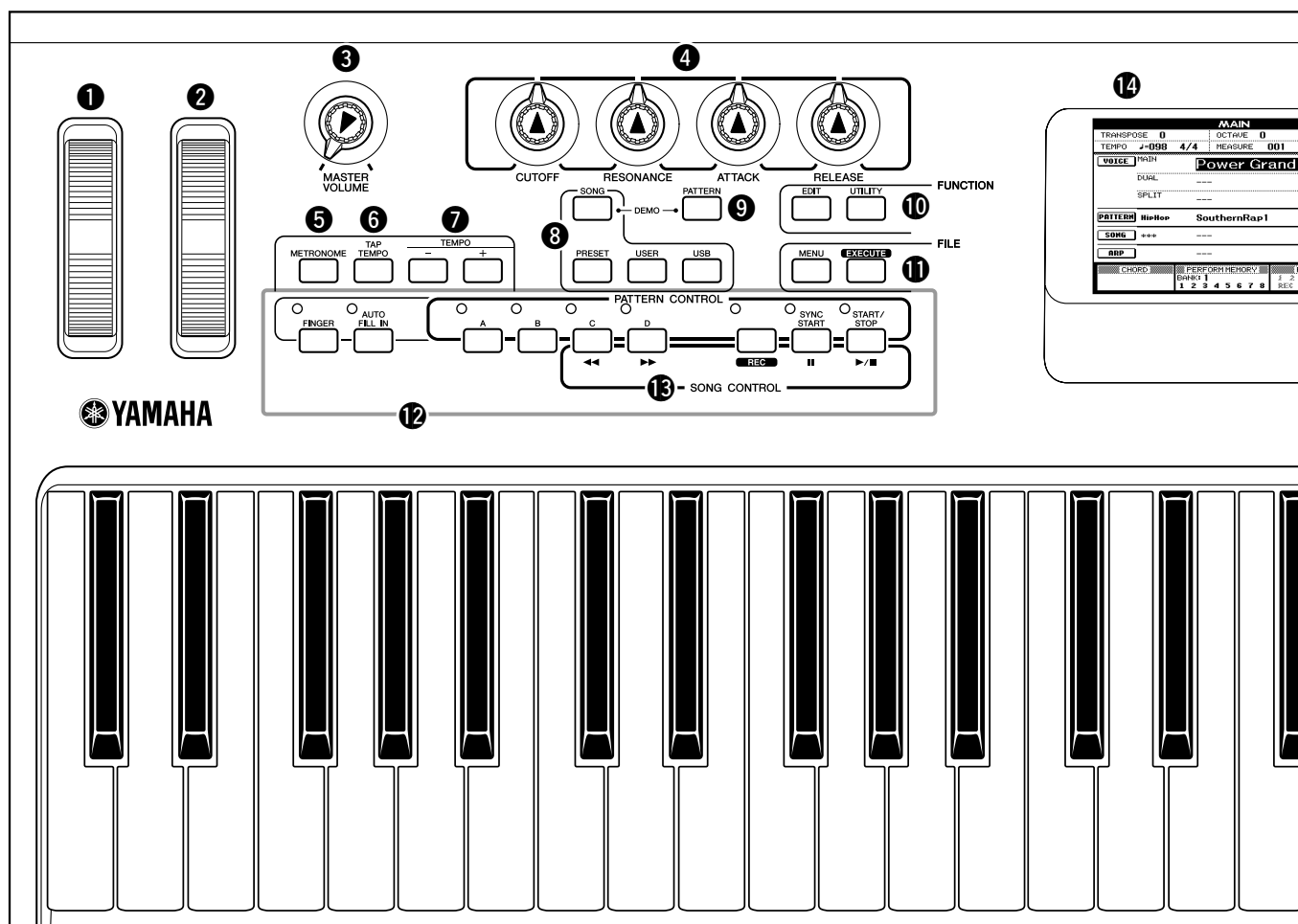

Front Panel

- ① [PITCH BEND] wheelpage 40
- ② [MODULATION] wheel.....page 40
- ③ [MASTER VOLUME] control.....pages 14, 36
- ④ [CUTOFF], [RESONANCE],
[ATTACK], [RELEASE] knobs.....page 41
- ⑤ [METRONOME] buttonpage 45
- ⑥ [TAP TEMPO] button.....page 47
- ⑦ TEMPO [+], [-] buttonspage 45
- ⑧ SONG
[SONG] button.....page 14
[PRESET], [USER], [USB] buttons.....page 26
- ⑨ [PATTERN] buttonpage 22
- ⑩ FUNCTION
[EDIT], [UTILITY] buttonspages 62, 64
- ⑪ FILE
[MENU], [EXECUTE] buttons.....pages 67, 68
- ⑫ PATTERN CONTROL
[FINGER] button page 23
[AUTO FILL IN] button..... page 51
[A]–[D] buttons page 51
[SYNC START] buttonpages 23, 51
[START/STOP] buttonpages 22, 37
- ⑬ SONG CONTROL
[◀◀] (REW) button page 27
[▶▶] (FF) button..... page 27
[REC] button page 30
[||] (PAUSE) button page 27
[▶/■] (START/STOP) button.....pages 27, 37
- ⑭ Display page 38
- ⑮ Dial page 37
- ⑯ [INC/YES], [DEC/NO] buttons page 37
- ⑰ [EXIT] button page 38
- ⑱ LCD CONTRAST knob page 11
- ⑲ CATEGORY [INC], [DEC] buttons page 37

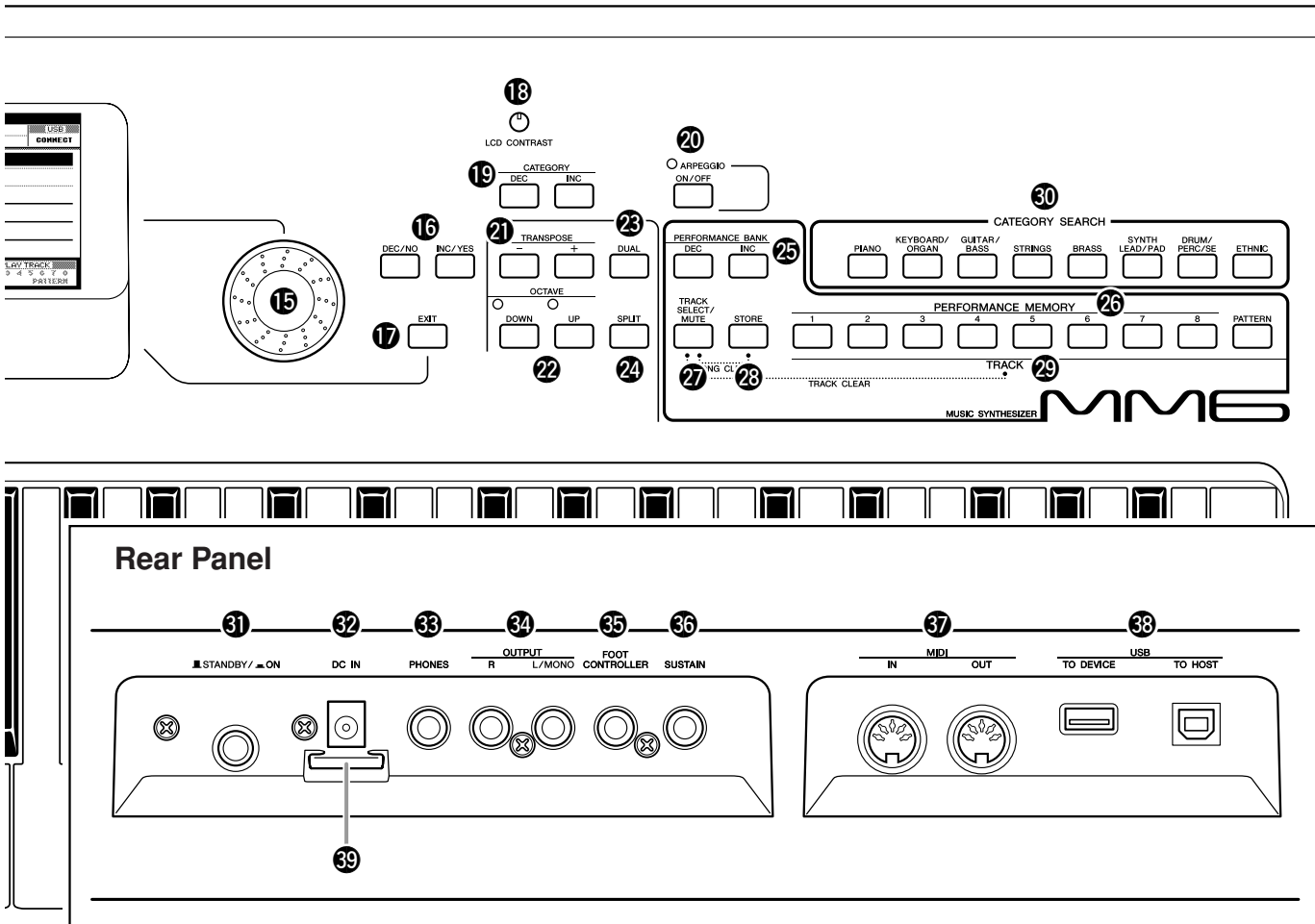

- 20 [ARPEGGIO ON/OFF] button.....page 20
- 21 TRANSPOSE [+], [-] buttons.....page 49
- 22 OCTAVE [UP], [DOWN] buttonspage 50
- 23 [DUAL] buttonpage 16
- 24 [SPLIT] button.....page 17
- 25 PERFORMANCE BANK [INC], [DEC] buttonspage 59
- 26 PERFORMANCE MEMORY [1]–[8] buttons.....page 59
- 27 [TRACK SELECT/MUTE] buttonpage 58
- 28 [STORE] button.....page 59
- 29 TRACK [1]–[8], [PATTERN] buttons.....page 29
- 30 CATEGORY SEARCH buttons.....page 15

Rear Panel

- 31 [STANDBY/ON] switch page 14
- 32 DC IN jack.....page 10
- 33 PHONES jack.....page 10
- 34 OUTPUT R, L/MONO jacks page 73
- 35 FOOT CONTROLLER jack page 41
- 36 SUSTAIN jack page 41
- 37 MIDI IN, OUT terminals..... page 73
- 38 USB TO DEVICE, TO HOST terminals..... page 73
- 39 Cable clip.....page 10

Playing the Demo Song

This instrument includes a Demonstration Song that demonstrate some of the instrument's features and capabilities. Let's start by playing the Demonstration Song.

1 Press the [STANDBY/ON] button until it locks in the ON position.

The Main display will appear in the LCD.

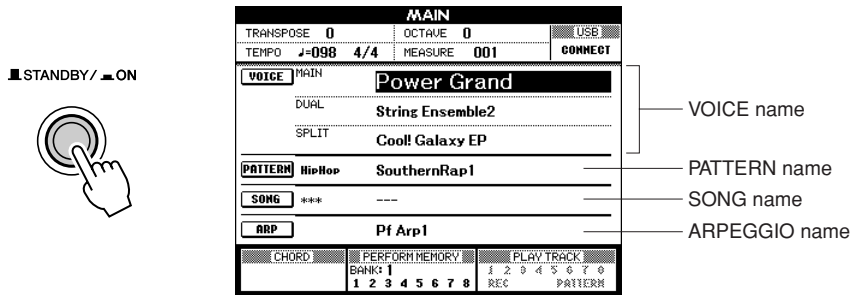

2 Press the [SONG] button and [PATTERN] button simultaneously.

The Demo display appears in the LCD

Gradually raise the [MASTER VOLUME] control while listening to the instrument to set the desired listening level.

The Demo Song will play again from the beginning when the end is reached.

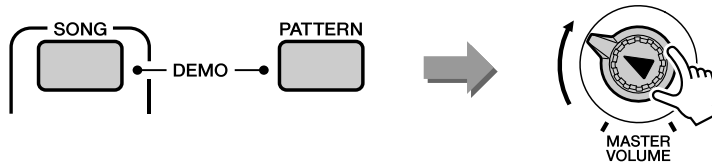

3 Press the [START/STOP] button to stop Demo playback.

The Main display will reappear.

NOTE

• The demo songs will not be transmitted via MIDI.

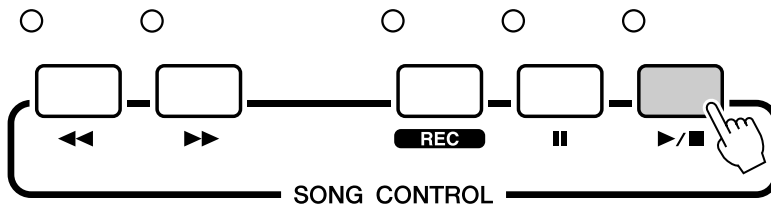

In addition to piano, organ, and other “standard” keyboard instruments, this instrument has a large range of realistic voices—including guitar, bass, strings, sax, trumpet, drums and percussion, sound effects, and a wide variety of other musical sounds.

Selecting the Main Voice

Select a Main Voice and play it on the keyboard.

1 Press a CATEGORY SEARCH button.

The Main Voice selection display will appear. The currently selected category name, voice number and name will be highlighted.

NOTE

- To change the Voice category, press another CATEGORY SEARCH button.

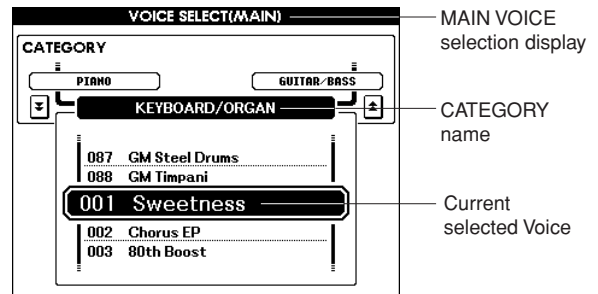
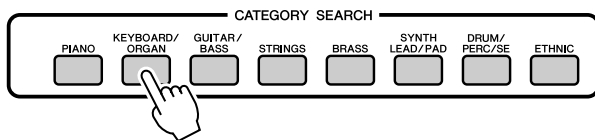

2 Select a voice you want to play from the current category.

Use the dial to select the desired voice. The available voices will be selected and displayed in sequence. The voice selected here becomes the Main voice.

For this example try selecting the “004 Early70’s”.

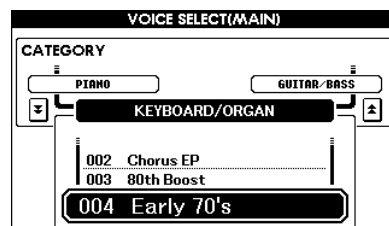
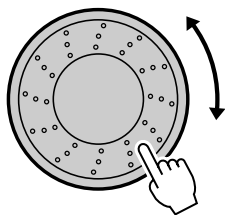

3 Play the keyboard.

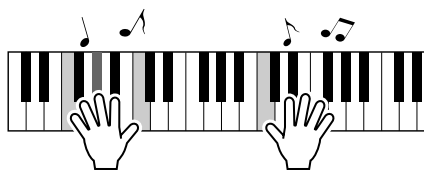

Try selecting and playing a variety of Voices. Press the [EXIT] button to return to the MAIN display.

Combining Voices—Dual

You can select a second voice that will play in addition to the main voice when you play the keyboard. The second voice is known as the “Dual” voice.

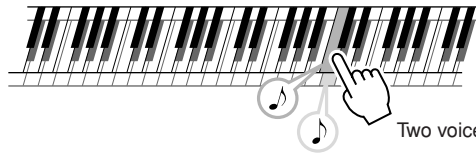

Two voices will sound at the same time.

1 Press the [DUAL] button.

The currently selected dual voice will sound in addition to the main voice when you play the keyboard.

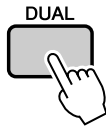

2 Press and hold the [DUAL] button for longer than a second.

The Dual Voice selection display will appear. The currently selected category name, voice number and name will be highlighted.

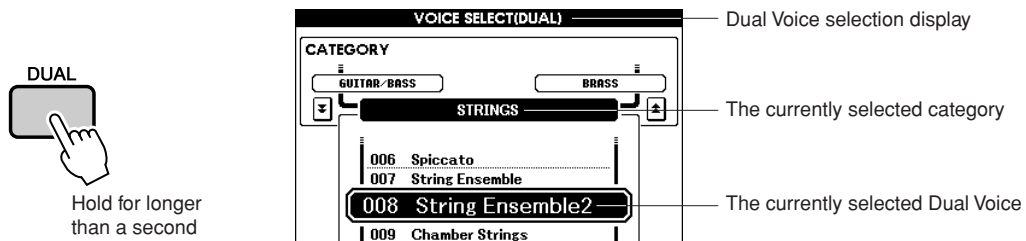

3 Select and press the desired category button in the CATEGORY SEARCH section.

NOTE

- To change the Voice category, press another category search button.

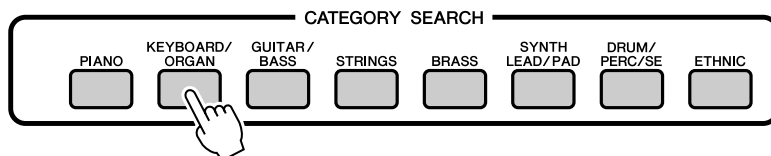

4 Select a voice you want to play.

Use the dial to select the desired voice. The available voices will be selected and displayed in sequence. The voice selected here becomes the Dual voice.

For this example try selecting the “057 Twinkle”.

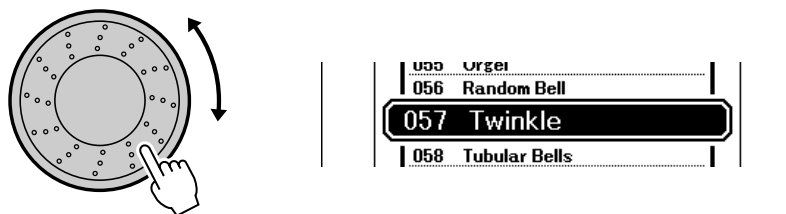

5 Play the keyboard.

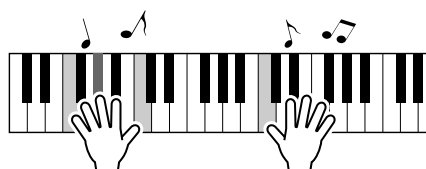

Try selecting and playing a range of Dual Voices.

Press the [EXIT] button to return to the MAIN display.

Split the Keyboard

In the split mode you can play different voices to the left and right of the keyboard “split point”. The main and dual voices can be played to the right of the split point, while the voice played to the left of the split point is known as the “split voice”. The split point setting can be changed as required (page 52).

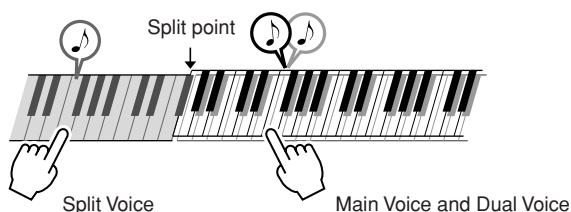

1 Press the [SPLIT] button.

The currently selected split voice will sound to the left of the keyboard split point.

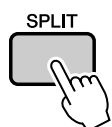

2 Press and hold the [SPLIT] button for longer than a second.

The Split Voice selection display will appear.

The currently selected category name, voice number and name will be highlighted.

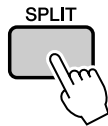

Hold for longer than a second

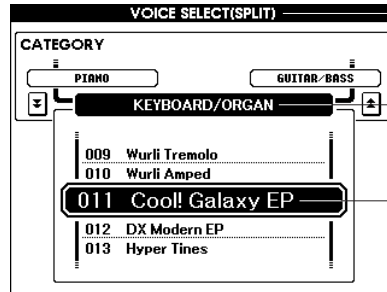

Split Voice selection display

The currently selected category

The currently selected Split Voice

3 Select and press the desired category button in the CATEGORY SEARCH section.

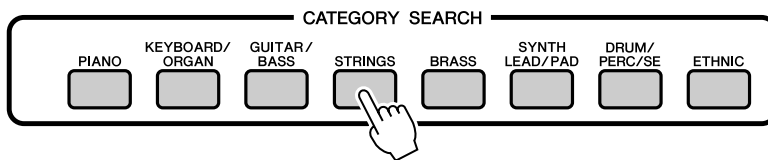

NOTE

• To change the voice category, press another CATEGORY SEARCH button.

4 Select a voice you want to play.

Use the dial to select the desired voice. The available voices will be selected and displayed in sequence. The voice selected here becomes the Split voice.

For this example try selecting the “002 Symphony Strings”.

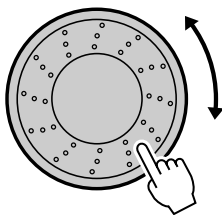

5 Play the keyboard.

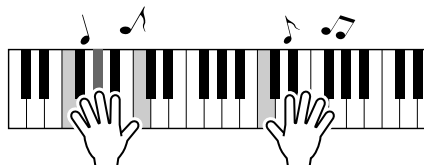

Try playing the selected Split Voice.

Press the [EXIT] button to return to the MAIN display.

Selecting a Drum Voice

Drum Kits are collections of drum and percussion instruments.

- 1 Press the [DRUM/PERC/SE] button.
The DRUM Kit category will appear in the display.

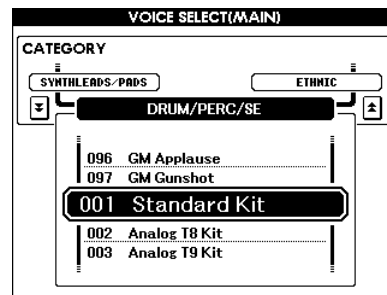
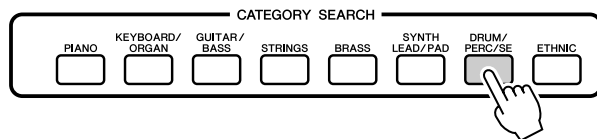

- 2 Use the dial to select the Drum Kit you want to play (001–023).

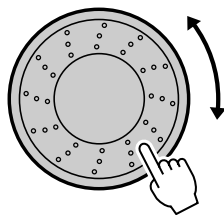

- 3 Play each key and enjoy the Drum Kit.

NOTE

- See the Drum Kit List on page 90.

Using the Arpeggio Function

The arpeggio function lets you create arpeggios (broken chords) by simply playing the required notes on the keyboard. For example, you could play the notes of a triad—the root, third, and fifth—and the arpeggio function will automatically create a variety of interesting arpeggio-type phrases. By changing the arpeggio type and the notes you play it is possible to create a wide range of patterns and phrases that can be used for music production as well as performance.

1 Press the [ARPEGGIO ON/OFF] button to turn Arpeggio on.

The indicator lights when ARPEGGIO is ON.

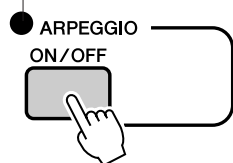

NOTE

- The Arpeggio function can only be applied to the main and dual voices. When Keyboard Out is set to ON (page 78), arpeggios will be transmitted via MIDI channel 1. When Dual Voice is used arpeggios will be transmitted via MIDI channel 2.

2 Play a note or notes on the keyboard to trigger Arpeggio playback.

The rhythm pattern or phrase that plays depends on the actual notes or chords you play, as well as on the selected Arpeggio type.

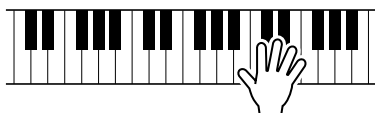

3 When you have finished using with the arpeggio function, press the [ARPEGGIO ON/OFF] button to turn it off.

■ Changing the Arpeggio type

The most suitable arpeggio type is automatically selected when you select a voice, but you can easily select any other arpeggio type.

1 Press and hold the [ARPEGGIO ON/OFF] button for longer than a second.

The arpeggio type selection display will appear.

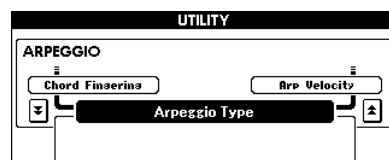
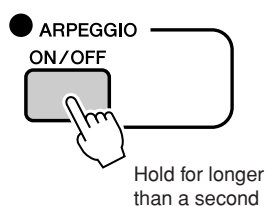

2 Use the dial to select the desired arpeggio type.

A list of the available arpeggio types is provided on page 104.

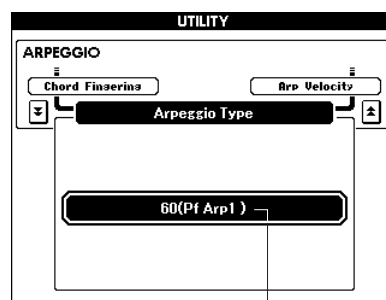
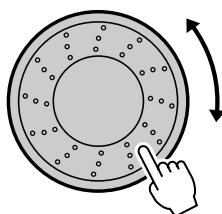

Arpeggio type

The sound of the arpeggio produced will change according to the number of notes you play and the area of the keyboard you play in. You can save the instrument's settings at this point and then recall them at any time you want to repeat your performance (page 59). You can also record your performance (page 29).

This instrument has an auto accompaniment feature that produces accompaniment (rhythm + bass + chords) in the pattern you choose to match chords you play with your left hand. A range of patterns with different time signatures and arrangements are provided (refer to the Pattern List on page 98).

In this section we'll learn how to use the auto accompaniment features.

Listen to the Rhythm Pattern

Most patterns include a rhythm part. You can select from a wide variety of rhythmic types—R&B, HipHop, Dance, and many, many more.

Let's begin by listening to just the basic rhythm. The rhythm part is played using percussion instruments only.

1 Press the [PATTERN] button.

The Pattern selection display will appear. The currently selected category name, voice number and name will be highlighted.

NOTE

To change the pattern category, use the CATEGORY [DEC]/[INC] buttons.

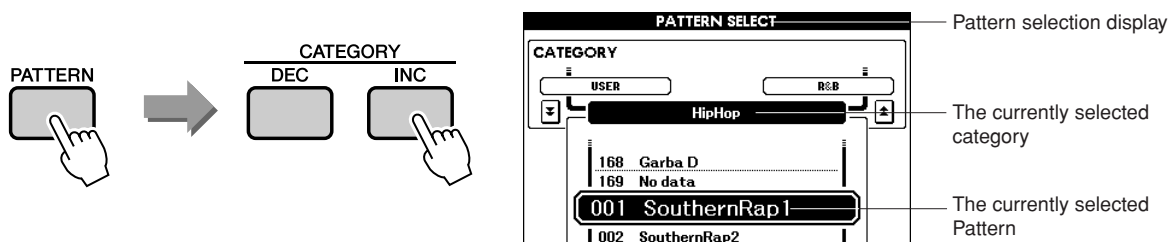

2 Select a Pattern you want to play.

Use the dial to select the pattern you want to play. The available patterns will be selected and displayed in sequence. Refer to the Pattern list on page 98.

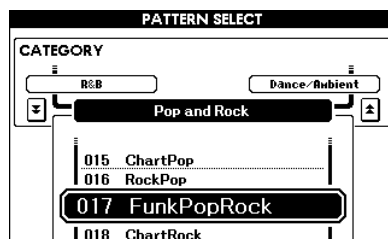
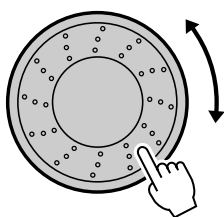

3 Press the [START/STOP] button.

The pattern rhythm will start playing. To stop playback, press the [START/STOP] button again.

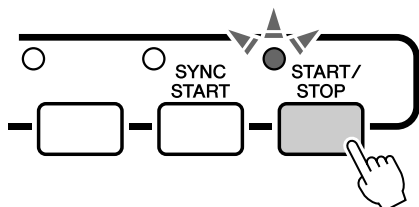

Play Along with a Pattern

You learned how to select a Pattern rhythm on the preceding page. Here we'll see how to add bass and chord accompaniment to the basic rhythm to produce a full, rich accompaniment that you can play along with.

1 Select the pattern you want to play (page 22, steps 1–2).

Press the [EXIT] button to return to the MAIN display screen.

2 Turn FINGER on.

Press the [FINGER] button.

Press the button a second time to turn the FINGER mode off.

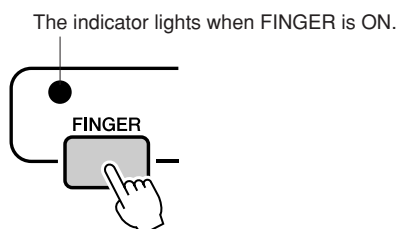

● When FINGER is on ...

The area of the keyboard to the left of the split point (54 : F sharp 2) becomes the “auto accompaniment range” and is used only for specifying the accompaniment chords.

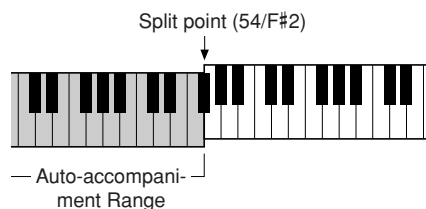

NOTE

- The keyboard split point can be changed as required, as described on page 52.

3 Turn sync start on.

Press the [SYNC START] button to turn the Sync Start function on.

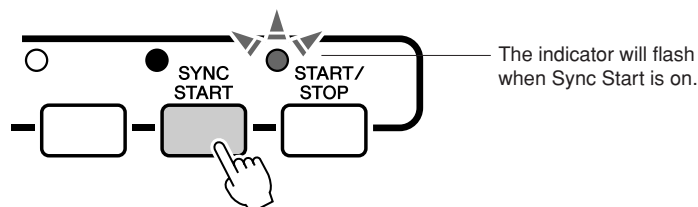

The “standby” mode will be engaged when the Sync Start function is turned on.

When sync start is on, the bass and chord accompaniment included in a pattern will start playing as soon as you play a note to left of the keyboard split point. Press the button a second time to turn the sync start function off.

4 Play a left-hand chord to start the pattern.

If you don't yet know how to play any chords, try playing anything you like on the keyboard. Refer to page 25 for information about playing chords.

The accompaniment will change according to the left-hand notes you play.

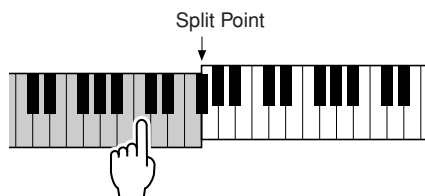

5 Play a variety of left-hand chords while playing a melody with your right hand.

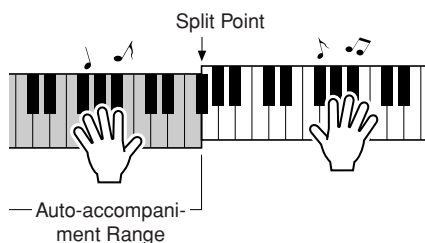

6 Press the [START/STOP] button to stop pattern playback when you're done.

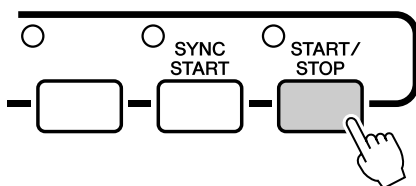

You can switch pattern “sections” to add variety to the accompaniment. Refer to “Pattern Variations (Sections)” on page 51.

Playing Auto-accompaniment Chords

There are two types of auto-accompaniment chords:

- **Easy Chords**
- **Standard Chords**

The instrument will automatically recognize the different chord types. This function is known as Multi Fingering.

The keyboard to the left of the split point (default: 54/F#2) becomes the “accompaniment range”. Play the accompaniment chords in this area of the keyboard.

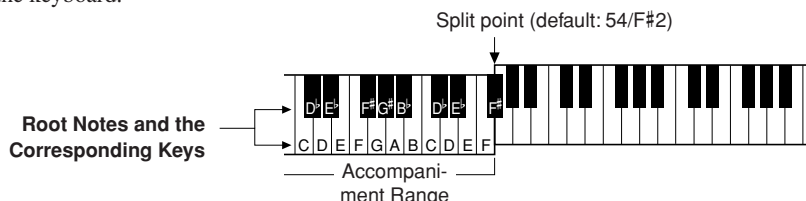

■ Easy Chords

This method lets you easily play chords in the accompaniment range of the keyboard using only one, two, or three fingers.

C	<ul style="list-style-type: none"> • To play a major chord Press the root note of the chord.
C_m	<ul style="list-style-type: none"> • To play a minor chord Press the root note together with the nearest black key to the left of it.
C₇	<ul style="list-style-type: none"> • To play a seventh chord Press the root note together with the nearest white key to the left of it.
C_{m7}	<ul style="list-style-type: none"> • To play a minor seventh chord Press the root note together with the nearest white and black keys to the left of it (three keys altogether).

■ Standard Chords

This method lets you produce accompaniment by playing chords using normal fingerings in the accompaniment range of the keyboard.

Standard Chord Fingerings [Examples for “C” chords]

Notes enclosed in parentheses () are optional; the chords will be recognized without them.

● Multi Fingering and Full Keyboard

These let you select the accompaniment section of the keyboard for chord playing.

When changing settings refer to “Specify Chords Over the Entire Keyboard Range” on page 56, and “Chord Fingering” on page 65.

Multi Fingering: As explained above, the keys to the left of the split point (default: 54, F#2) become the accompaniment range. Playing Auto-accompaniment Chords. There are two ways of playing auto-accompaniment chords: Easy Chords and Standard Chords. The default setting (factory setting) is “Multi Fingering.”

Full Keyboard: This let you play the accompaniment chords freely from anywhere on the keyboard.

With this instrument the term “song” refers the data that makes up a piece of music.

In this section we’ll learn how to select and play songs.

Selecting and Listening to a Song

1 Select and press the SONG category button that corresponds to the type of song you want to listen to.

[PRESET]: Accesses the three internal preset songs.

[USER] : Accesses songs you have recorded yourself and songs loaded from computer.

[USB] : Accesses songs stored on a USB storage device connected to the DEVICE terminal.

The song selection display will appear.

The currently selected song number and name will be highlighted.

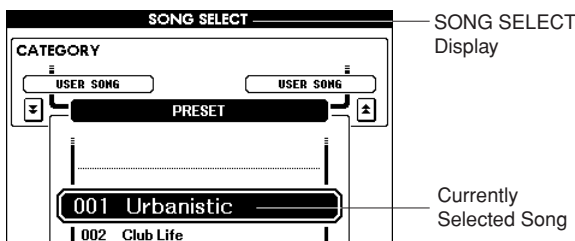
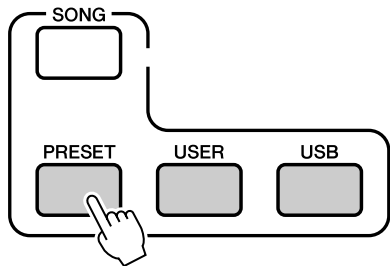

2 Select a song you want to play.

Use the dial to select the Song you want to listen to.

The available songs will be selected and displayed in sequence.

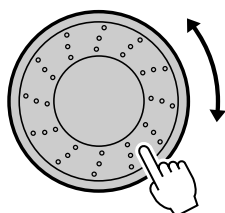

NOTE

• User songs (songs you’ve recorded yourself) and songs on USB storage devices can also be played. The procedure for playing these types of songs is exactly the same as for playing the internal songs.

PRESET	Internal songs (three songs)
USER	User songs (songs you have recorded yourself; page 29)
USB	Songs stored on a USB storage device connected to the instrument (page 67)

3 Listen to the song.

Press the [START/STOP] button to begin playback of the selected song. You can stop playback at any time by pressing the [START/STOP] button again.

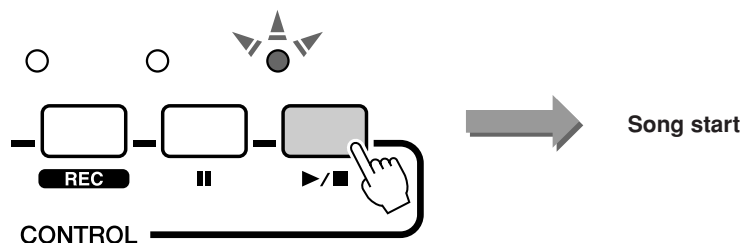

Song Fast Forward, Fast Reverse, and Pause

These are just like the transport controls on a CD player, letting you fast forward [▶▶], reverse [◀◀] and pause [||] playback of the song.

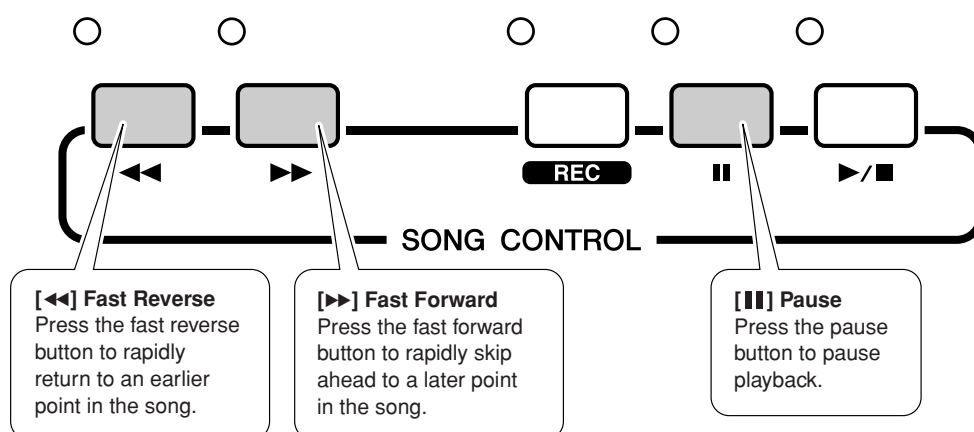

Types of Songs

The following three types songs can be used by this instrument.

- **Preset Songs** (the three songs built into the instrument) **Song numbers 001–003.**
- **User Songs** (recordings of your own performances) **Song numbers 001–005.**
- **USB Songs** (songs data in USB storage device)..... **Song numbers 001–**

The chart below shows the basic flow for using the preset songs, user songs, and USB songs from storage to playback.

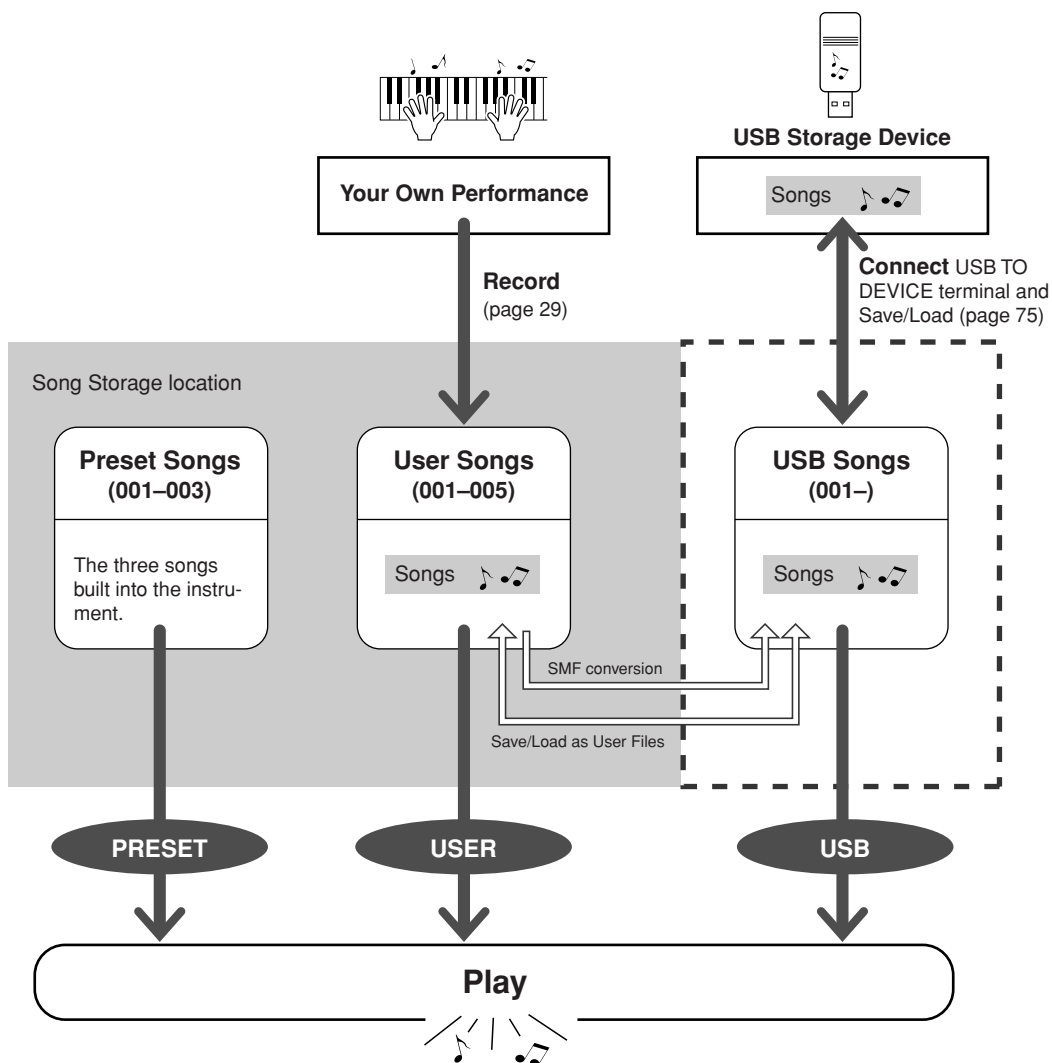

You can record up to five of your own performances and save them as user songs 001 through 005. These Songs can be played in the same manner as the preset Songs.

Once your performances have been saved as user Songs, they can be converted to SMF (Standard MIDI File) format files and saved to USB storage device (page 70).

■ Recordable data

Eight tracks of keyboard performance and one pattern track (chord performance) can be recorded.

Each track can be recorded individually.

- Tracks [1]–[8] Record keyboard performance (main voice only).
- [PATTERN] Track Records pattern rhythm and chord parts.

■ Track Mute

This instrument allows you to choose whether recorded tracks will play back while you are recording or playing back other tracks (page 58).

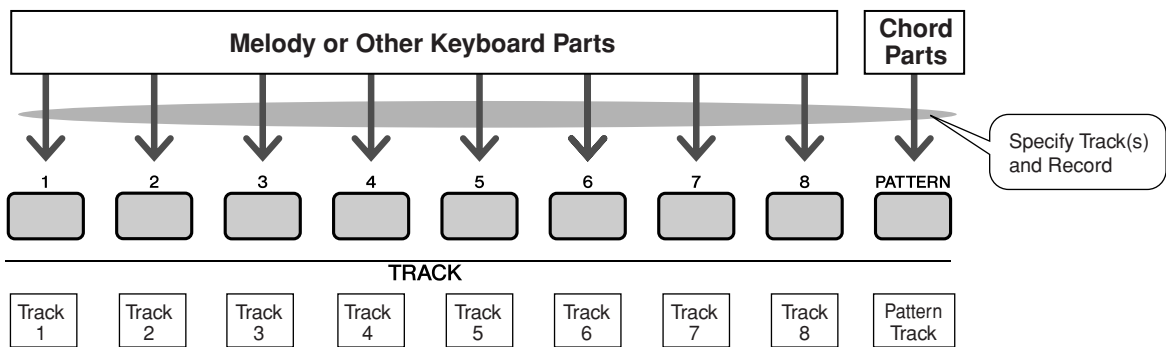

Recording Procedure

Begin recording after selecting a user song number, and the track and part you want to record.

- From the MAIN display press the [USER] button, then use the dial to select the user song number (001–005) you want to record.

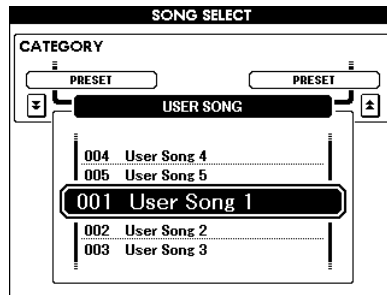
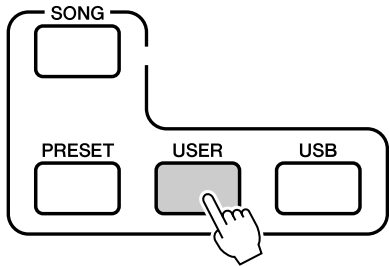

- Press the [REC] button.
The [REC] button will light.

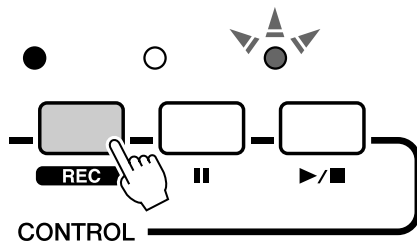

- Select the recording track.
Press the TRACK button ([1] to [8]) you want to record to while holding the [TRACK SELECT/MUTE] button.
The selected track will flash in the display.

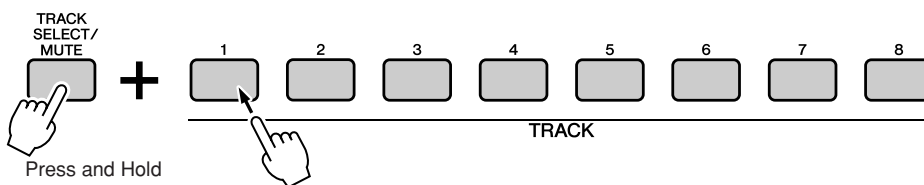

Track 1 will be highlighted.

CAUTION

- If you record to a track that contains previously-recorded data the previous data will be overwritten and lost.

NOTE

- The FINGER mode will be automatically turned on when you select the [PATTERN] track for recording.
- The FINGER mode cannot be turned on or off once you have started recording.

◆ **Pattern Track Selected for Recording**

Press the TRACK [PATTERN] button while holding down the [TRACK SELECT/MUTE] button.

The pattern track will be highlighted and the record standby mode will be engaged.

NOTE

- To cancel recording to a selected track, press that track button a second time. The FINGER mode cannot be turned on or off once you have started recording.

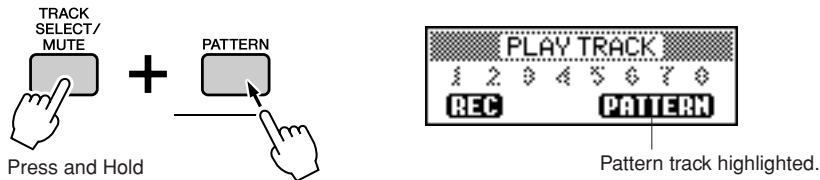

◆ **Changing the Pattern Being Recorded**

Press the [PATTERN] button and use the dial to select the desired pattern. Once the pattern has been selected press the [EXIT] button.

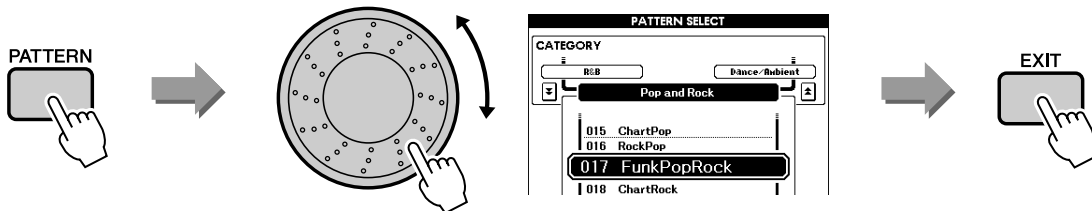

4 Recording will start when you play on the keyboard.

You can also start recording by pressing the [START/STOP] button. Press the [EXIT] button, and the measure number will be shown in the Main display.

NOTE

- If the memory becomes full during recording a warning message will appear and recording will stop automatically. Use the song clear or track clear function (page 33) to delete unwanted data and make more room available for recording, then do the recording again.

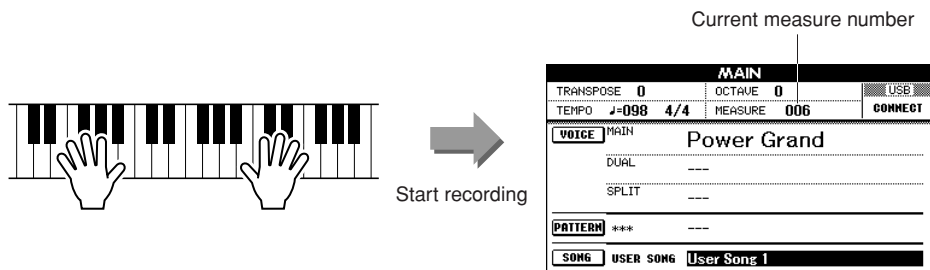

5 Stop recording by pressing the [START/STOP] or [REC] button.

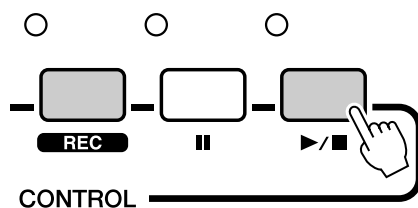

When recording stops the current measure number will return to 001 and the recorded track numbers in the display will appear with a frame around them.

■ **To Record Other Tracks**

Repeat steps 2 through 5 to record any of the remaining tracks.

By pressing the TRACK [1]–[8] and/or [PATTERN] button(s) it becomes possible to monitor previously recorded tracks (displayed with a frame around the track number) while recording a new track. Previously recorded tracks can also be muted (displayed without a frame around the track number) while recording a new track (page 58).

■ **To Re-record a Track**

Simple select the track you want to re-record for recording in the normal way. The new material will overwrite the previous data.

6 When the recording is done ...

◆ **To Play Back a User Song**

The procedure is the same as that for Preset Songs (See page 26).

1 Press the [USER] button.

2 The current Song number/name will be highlighted-use the dial to select the user Song (001 to 005) you want to play.

3 Press the [START/STOP] button.

◆ **Save the User Song to USB storage device (See page 69)**

◆ **Convert the Song Data to SMF Format and then Save to USB storage device (See page 70)**

The following data is recorded before the beginning of the Song. Even if you change the data while recording is in progress, the data is not recorded.

- Reverb type, Chorus type, Time signature, Pattern number, Pattern volume

Song Clear—Deleting User Songs

This function clears an entire user song (all tracks).

1 From the MAIN display, select the user song (001 to 005) you want to clear.

2 Press and hold the [TRACK SELECT/MUTE] button for longer than a second while holding the [STORE] button.

A confirmation message will appear on the display.

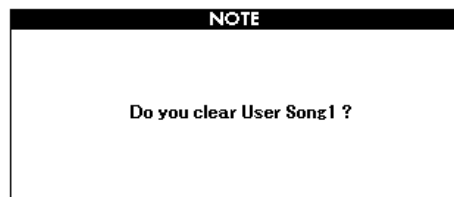
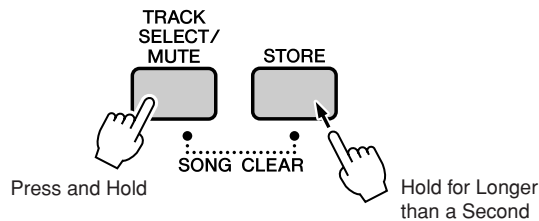

3 Press the [INC/YES] button.
A confirmation message will appear on the display.
Press [DEC/NO] to cancel the Song Clear operation.

4 To execute the Song Clear function press the [INC/YES] button.

The clear-in-progress message will appear briefly on the display while the song is being cleared.

NOTE

- If you only want to clear a specific track from a user song use the Track Clear function.

NOTE

- To execute the Song Clear function, press the [INC/YES] button. Press [DEC/NO] button to cancel the Song Clear operation.

Track Clear—Deleting a Specified Track from a User Song

This function lets you delete a specified track from a user song.

1 From the MAIN display, select the user song (001 to 005) that contains the track you want to clear.

2 Press the TRACK button [1] to [8] you want to clear to while holding the [TRACK SELECT/MUTE] button.

To erase the pattern track, press the TRACK [PATTERN] button for longer than one second while holding the [TRACK SELECT/MUTE] button.

A confirmation message will appear on the display.

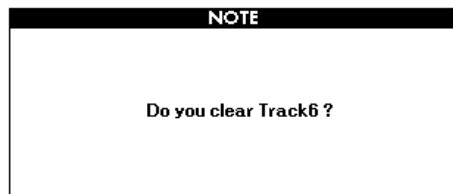
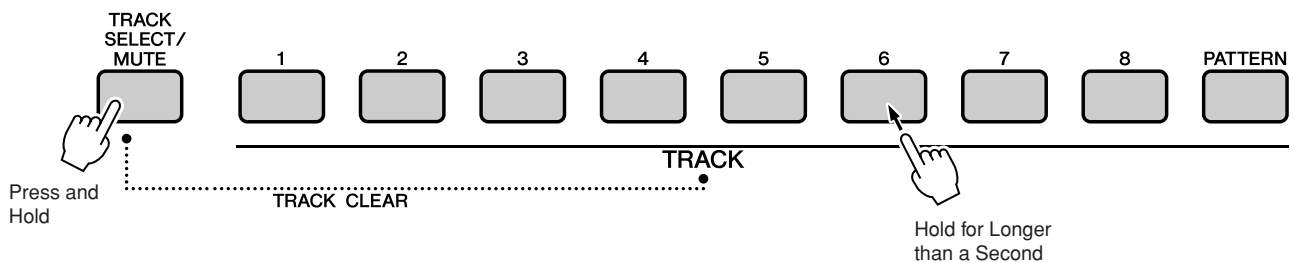

3 Press the [INC/YES] button.

A confirmation message will appear on the display. Press [DEC/NO] to cancel the Track Clear operation.

4 To execute the Track Clear function press the [INC/YES] button.

The clear-in-progress message will appear briefly on the display while the track is being cleared.

NOTE

- To execute the Track Clear function, press the [INC/YES] button. Press [DEC/NO] button to cancel the Track Clear operation.

Backup and Initialization

Backup

The following settings are always backed up, and are maintained even when the power is turned off. If you want to initialize the settings, use the Initialize operation as explained below.

● The Backup Parameters

- User Song
- Pattern file
- Performance memory
- The parameters in the UTILITY/EDIT display
 - Split point, Touch sensitivity, Pattern volume, Song volume, Metronome volume, Demo cancel, Master EQ type, Chord fingering, Tuning, Arpeggio velocity
- Panel Setting: AUTO FILL IN

Initialization

This function erases all backup data in the instrument's memory and restores the initial default settings.

■ Backup Clear.....

To clear the backed up data, turn the power on by pressing the [STANDBY/ON] switch while holding the highest white key on the keyboard. The backed up data will be erased and the default values restored.

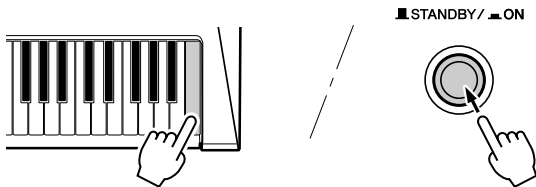

Basic Operation and Displays

Basic Operation

Overall MM6/MM8 control is based on the following simple operations.

1 Press a button to select a basic function.

2 Use the dial to select an item.

3 Start/Stop a function.

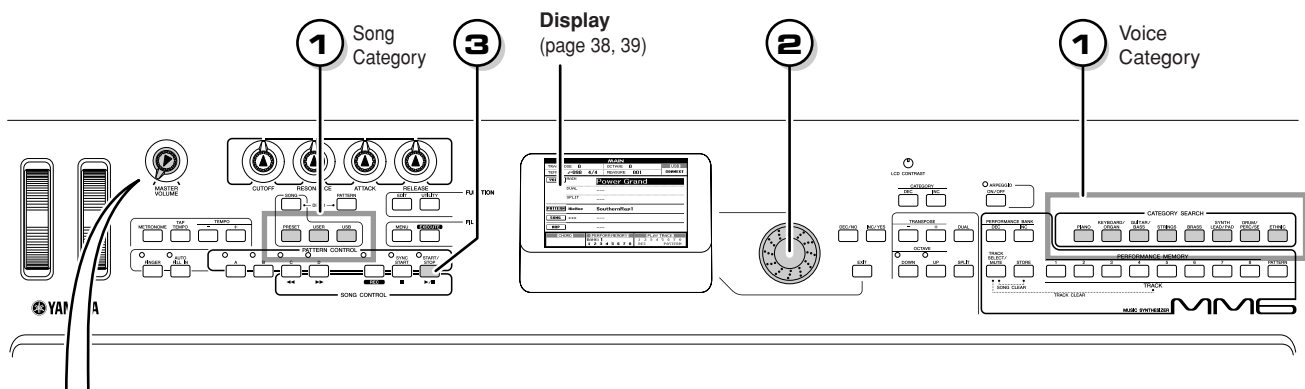

● Volume Adjustment

Adjust the volume of the sound heard from the speakers plugged into the OUTPUT jack or a pair of headphones plugged into the PHONES jack.

Rotate counter-clockwise to lower the volume.

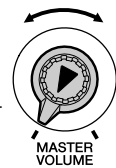

Rotate clockwise to increase the volume.

1 Press a button to select a basic function.

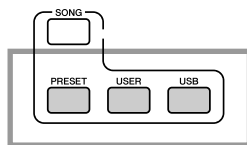

● Song category

Select the song category containing the song you want to play.

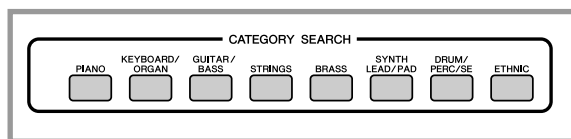

● Voice category

Select the voice category containing the voice you want to play.

* If you want to change the category, press another category button or use the CATEGORY [DEC]/[INC] buttons.

● **CATEGORY [INC]/[DEC]**

You can quickly select a different category after you've selected a song, pattern or voice category. These buttons can be used to step through the categories in sequence.

Example: Voice Selection Display

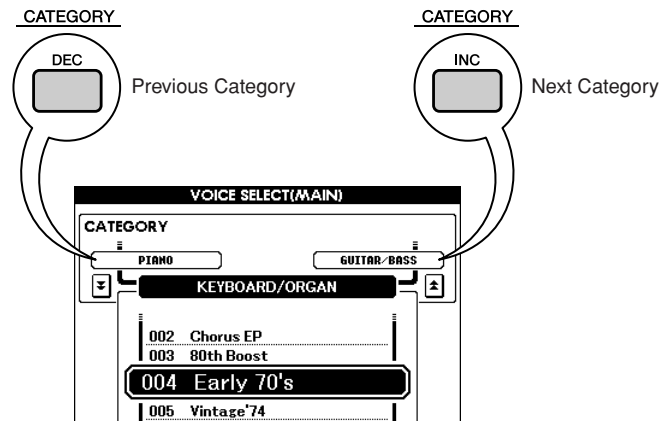

2 Use the dial to select an item.

When a basic function is selected, the category name will appear near the top of the display, and the currently selected item will be highlighted below it. Different items can be selected by using the dial or the [INC/YES] and [DEC/NO] buttons.

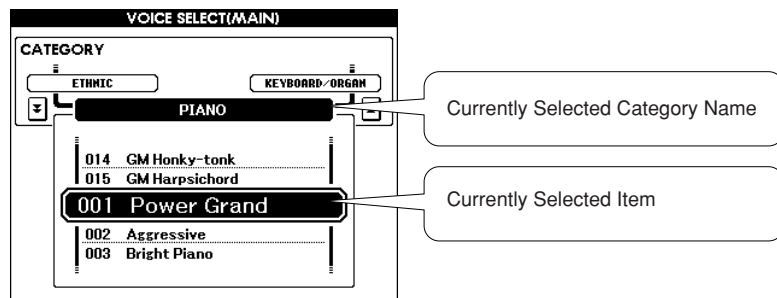

● **Dial**

Rotate the dial clockwise to increase the value of the selected item, or counterclockwise to decrease its value. Rotate the dial continuously to continuously increase or decrease the value.

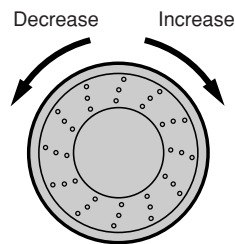

● **[INC/YES], [DEC/NO] Buttons**

Press the [INC/YES] button briefly to increment the value by 1, or press the [DEC/NO] button briefly to decrement the value by 1. Press and hold either button to continuously increment or decrement the value in the corresponding direction.



In most procedures described throughout this owner's manual the dial is recommended for selection simply because it is the easiest and most intuitive selection method. Please note however, that most items or values that can be selected using the dial can also be selected using the [INC/YES] and [DEC/NO] buttons.

3 Start/Stop a function.

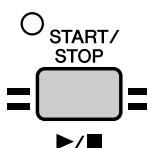

Use the [START/STOP] button.
 Press this button after selecting a song or pattern to start song or pattern (rhythm) playback.
 Press the button a second time to stop playback.

The Displays

● Display names

The display provides all the information you need to easily operate the instrument. The name of the current display appears at the top of the screen. For example, “MAIN” appears at the top on the main display.

● MAIN display

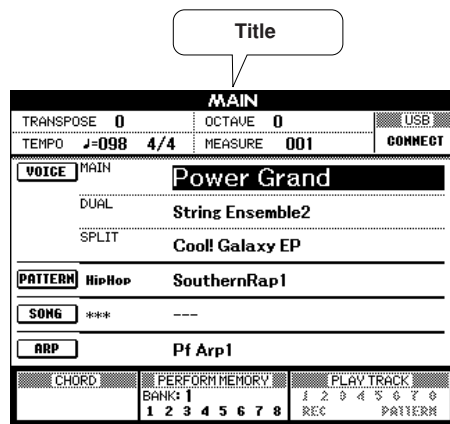

● Call Up The Main Display



Most basic operations are carried out from the instrument's MAIN display. You can return to the MAIN display from any other display by pressing the [EXIT] button near the dial.

● UTILITY/EDIT display (page 64, 62)

The UTILITY/EDIT displays provide access to 46 items (25 UTILITY items and 21 EDIT items) that can be edited.

The UTILITY or EDIT display appears when the [UTILITY] or [EDIT] button is pressed. Each time the CATEGORY [DEC]/[INC] buttons described on page 37 are pressed a new item is selected from the 46 items available.

Press the CATEGORY [DEC]/[INC] button(s) as many times as necessary until the required function appears. You can then use the dial or [INC/YES] or [DEC/NO] buttons to adjust the value of the function as required.

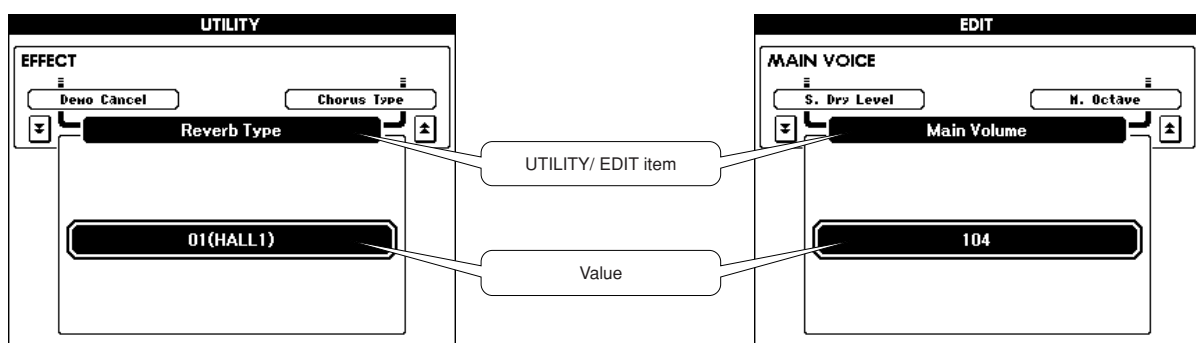

MAIN Display Items

The MAIN display shows all of the current basic song, pattern, and voice settings. It also includes a range of indicators that show the on/off status of a several functions.

Since this display lets you see all of the current basic settings in one centralized area, it is a good idea to have it showing while playing.

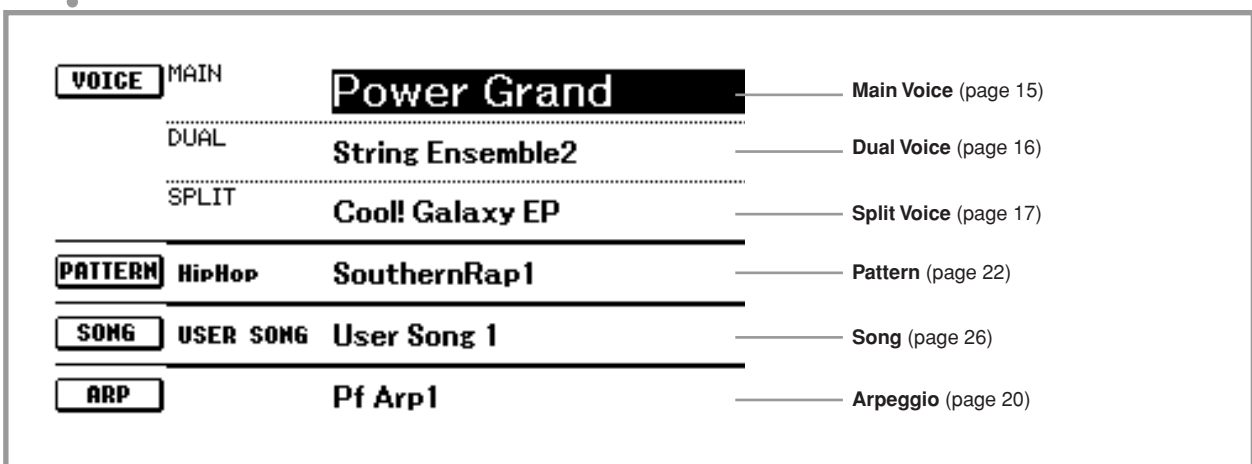
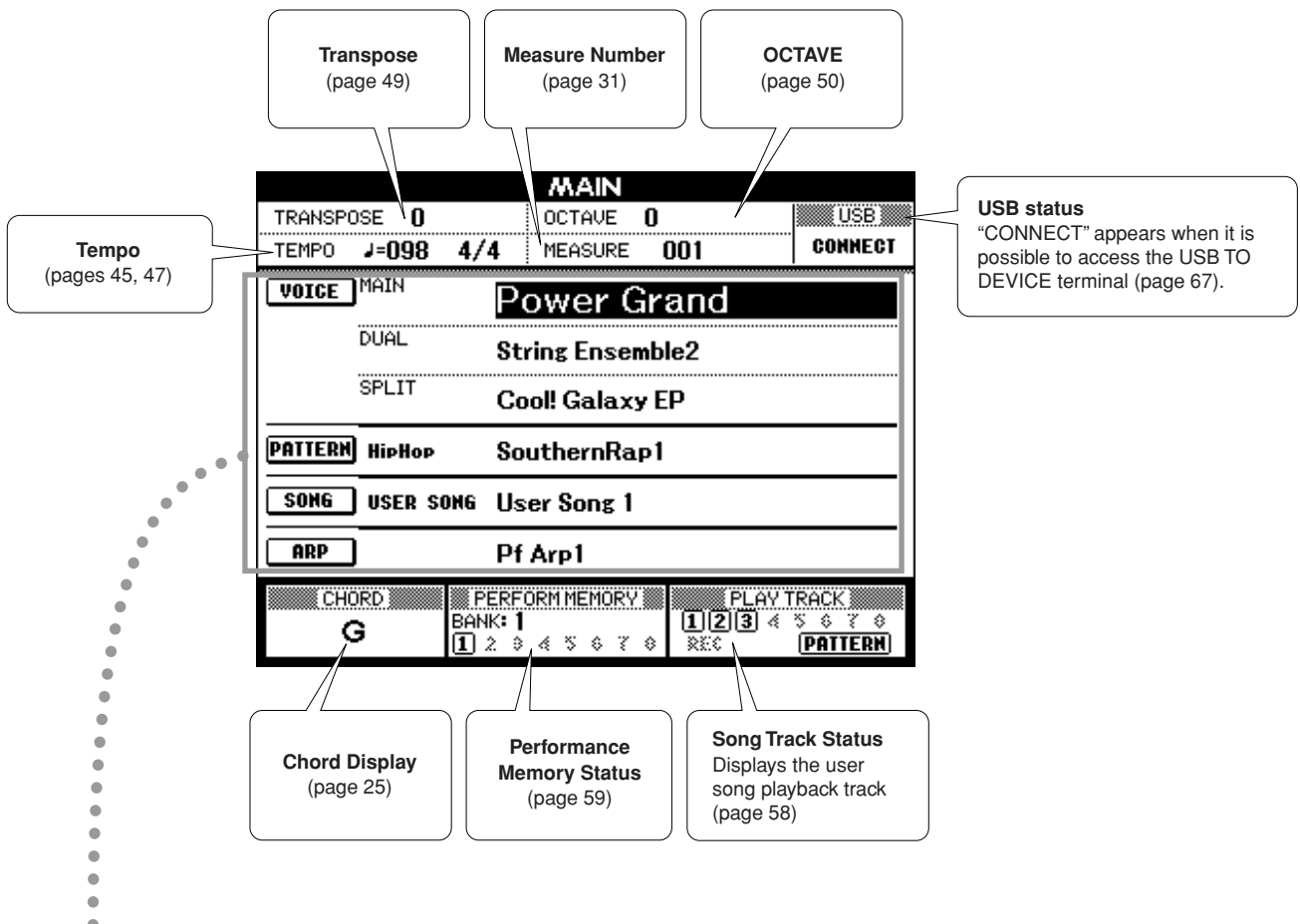

Using the Controllers

You can control tone, volume, pitch and other parameters by using the controllers on the front panel, as well as by using external controllers connected to several controller jacks on the rear panel.

Controllers on the front panel

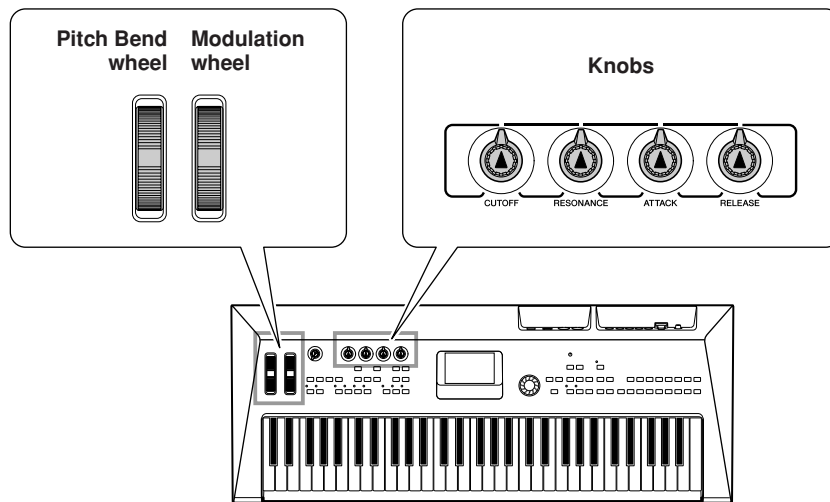

■ Pitch Bend wheel

Use the Pitch Bend wheel to bend notes up (roll the wheel away from you) or down (roll the wheel toward you) while playing the keyboard. This wheel is self-centering and will automatically return to normal pitch when released. Try out the Pitch Bend wheel while pressing a note on the keyboard.

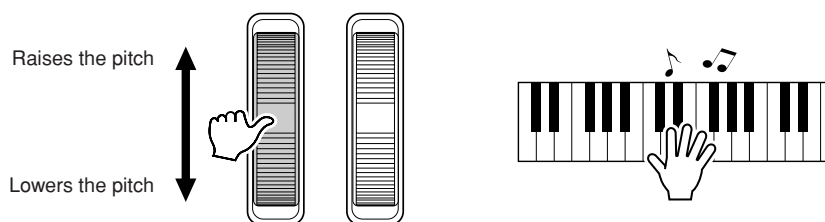

■ Modulation wheel

This controller is used to apply vibrato to the keyboard sound. The more you move this wheel up, the greater the effect that is applied to the sound. Try out the Modulation wheel with various Preset Voices while playing the keyboard.

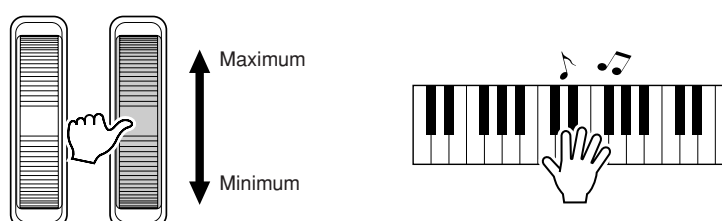

■ Knobs

You can change the brightness and tonal characteristics of the current Main Voice and Dual Voice in real time by turning the knobs while you play.

Turn a knob to the right to increase the value, and left to decrease it.

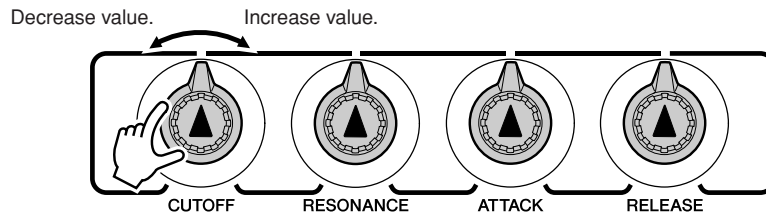

CUTOFF	Raises or lowers the filter cutoff frequency to adjust the brilliance of the tone.
RESONANCE	Adjusts the peak level around the cutoff frequency.
ATTACK	Determines the attack time of the sound. For example, you can adjust a strings voice so that the sound gradually swells in volume by setting a slow attack time ... simply turn this knob to the right.
RELEASE	Determines the release time of the sound. Turning the knob to the right increases the release time and (depending on the voice) lets the sound sustain after the key is released. To produce a sharp release, in which the sound abruptly cuts off, set a short release time.

External Controllers

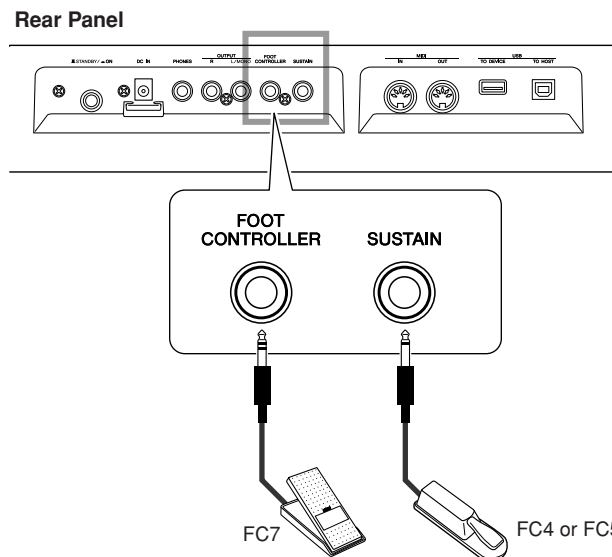

■ Footswitch

An optional FC4 or FC5 Footswitch connected to the SUSTAIN jack on the rear panel lets you control sustain. For example, you can turn sustain on or off with your foot while playing with both hands.

NOTE

• Sustain can be applied only to the main and dual voices.

■ Foot Controller

You can connect an optional Foot Controller (FC7) to the FOOT CONTROLLER jack on the rear panel. The ability to control volume with your foot can be an advantage during live performance.

Selecting a Reverb type

Reverb lets you play with concert hall type ambience.

When you select a pattern or song the optimum reverb type for the voice used is automatically selected. If you want to select a different reverb type, use the procedure described below. Only one reverb type can be selected.

- 1 Press the [UTILITY] button to go to the UTILITY display.**

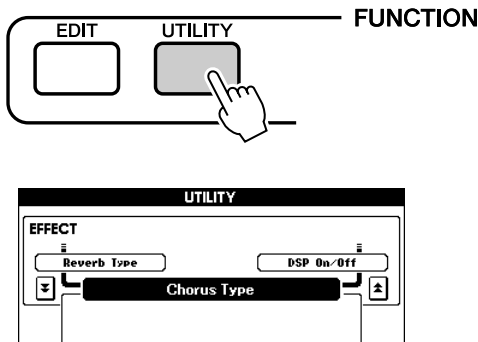

- 2 Use the CATEGORY [DEC]/ [INC] buttons to select the Reverb Type item.**

The currently selected reverb type will be displayed.

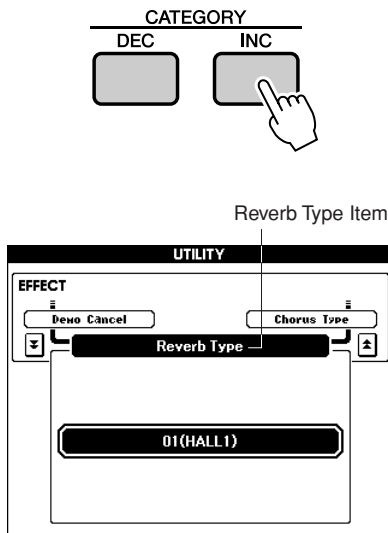

- 3 Use the dial to select a reverb type.**

You can check how the selected reverb type sounds by playing on the keyboard.

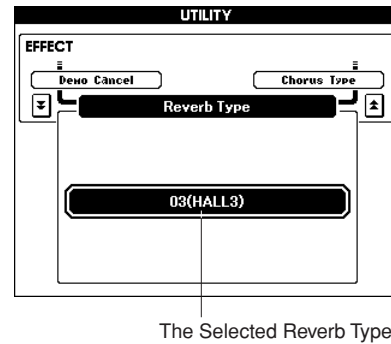
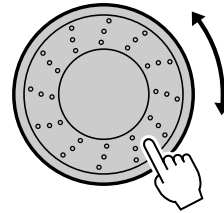

Refer to the Effect Type List on page 100 for information about the available reverb types.

● Adjusting the Reverb Send Level

You can individually adjust the amount of reverb that is applied to the main, dual, and split voices. (page 63)

Selecting a Chorus type

The chorus effect creates a thick sound that is somewhat like a number of similar voices being played in unison.

When you select a pattern or song the optimum chorus type for the voice used is automatically selected. If you want to select a different chorus type, use the procedure described below. Only one chorus type can be selected.

- 1 Press the [UTILITY] button to go to the UTILITY display.

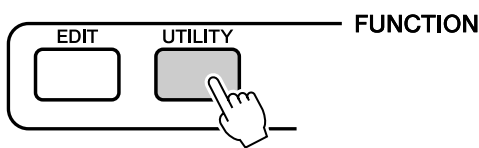

- 2 Use the CATEGORY [DEC] / [INC] buttons to select the Chorus Type item.

The currently selected chorus type will be displayed.

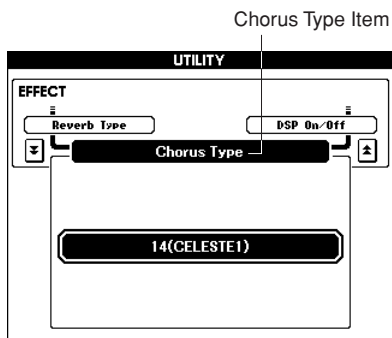
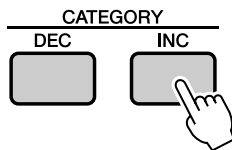

- 3 Use the dial to select a chorus type.

You can check how the selected chorus type sounds by playing on the keyboard.

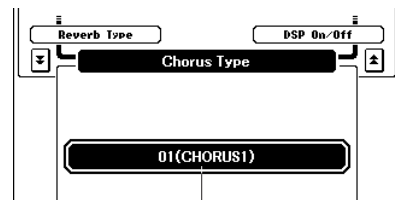
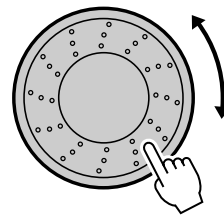

The Selected Chorus Type

Refer to the Effect Type List on page 100 for information about the available chorus types.

● Adjusting the Chorus Send Level

You can individually adjust the amount of chorus that is applied to the main, dual, and split voices. (page 63)

Applying DSP Effects

These effects can be used to add depth and richness to voices played on the keyboard (main, dual, and split voices). Only one DSP type can be selected.

NOTE

DSP stands for "Digital Signal Processor", which is a special microprocessor designed to process and add effects to digital audio signals.

1 Press the [UTILITY] button to go to the UTILITY display.

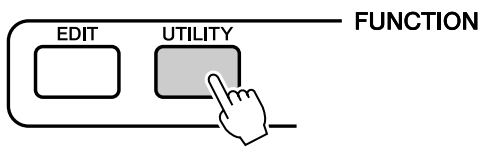

2 Use the CATEGORY [DEC] / [INC] buttons to select the DSP ON/OFF item.

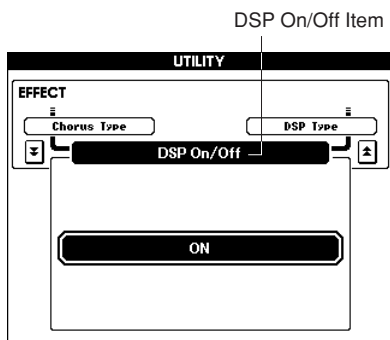
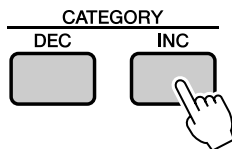

3 Use the dial to set the DSP ON or OFF as required.

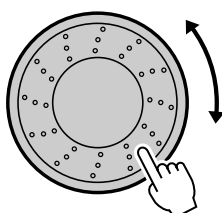

Changing the DSP type.....

1 Press the [UTILITY] button to go to the UTILITY display.

2 Use the CATEGORY [DEC] / [INC] buttons to select the DSP Type item.

The currently selected DSP type is displayed.

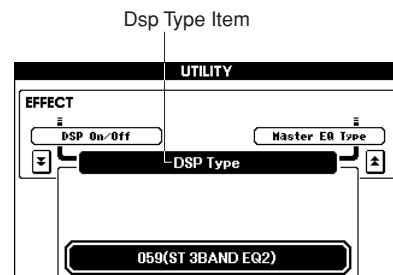
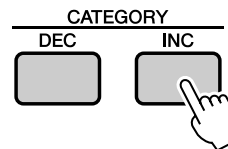

3 Use the dial to select a DSP type.

You can check how the selected chorus type sounds by playing on the keyboard. Refer to the DSP Type List on page 101 for the available DSP types.

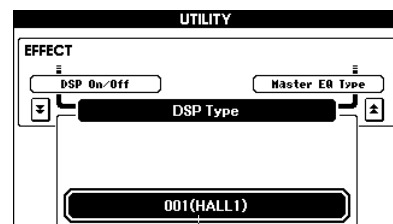
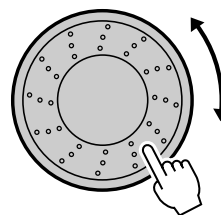

The Selected DSP Type

Press the [INC/YES] and [DEC/NO] buttons simultaneously to recall the initial default value.

Handy Performance Features

Using the Metronome

The instrument includes a metronome with adjustable tempo and time signature. Use it to set the tempo that is most comfortable for you and the music you are playing.

■ Start the metronome

Start the metronome by pressing the [METRONOME] button.

To stop the metronome, press the [METRONOME] button again.

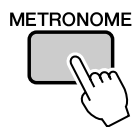

The Beat of the Current Measure

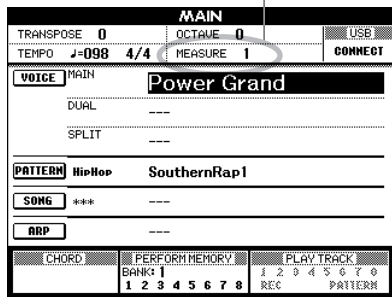

■ Adjusting the Metronome Tempo

Here's how you can adjust the tempo of the metronome sound.

- 1 Press the TEMPO [+] button to increase the tempo value by 1, or the TEMPO [-] button to decrease the tempo by 1.

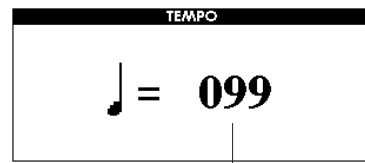
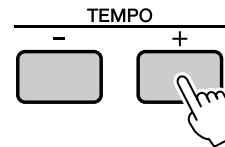

Tempo Display

- 2 Use the dial to select a tempo from 11 to 280.

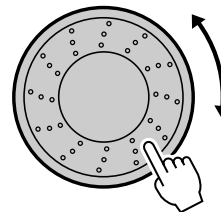

Press the [EXIT] button to return to the original display.

Press the TEMPO [+] or [-] button as many times as necessary to set the desired tempo. You can also hold either of the TEMPO buttons to continuously change the tempo value over large ranges.

■ Setting the Number of Beats per Measure, and the Length of Each Beat

In this example we'll set up a 3/8 time signature.

1 Press and hold the [METRONOME] button for longer than a second.

The metronome time signature and length of each beat will be shown on the display.

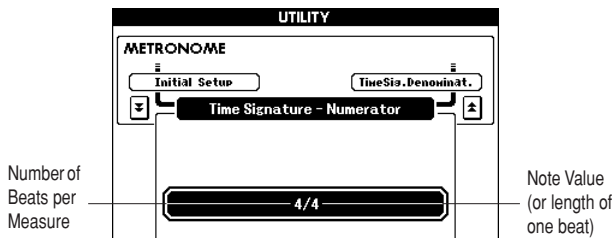
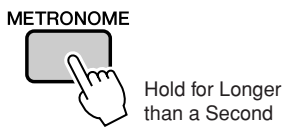

2 Use the dial to select the number of beats per measure.

A chime will sound on the first beat of each measure while the other beats will click. All beats will simply click with no chime at the beginning of each measure if you set this parameter to "00".

The available range is from 0 through 60. Select 3 for this example.

NOTE

• The metronome time signature will synchronize to a pattern or song that is playing, so these parameters cannot be changed while a pattern or song is playing.

3 Press the category [INC] button once to display "Time Signature – Denominator".

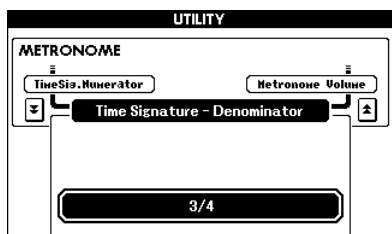
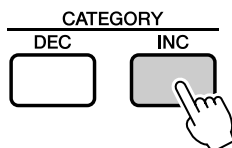

4 Use the dial to select a beat length.

Select the required length for each beat: 2,4,8 or 16 (half note, quarter note, eighth note, or 16th note). For this example, select 8. The time signature should now be set to 3/8.

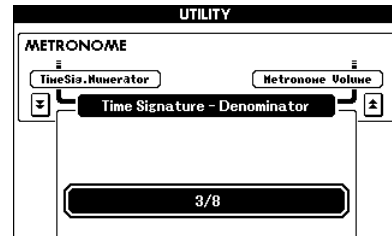

Press the [METRONOME] button to confirm the settings.

■ Adjusting the Metronome Volume

1 Press the [UTILITY] button to go to the UTILITY display.

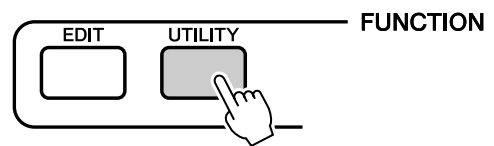

2 Press the [DEC] / [INC] category button until the "Metronome Volume" item appears on the display.

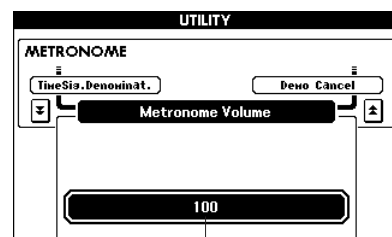
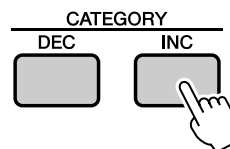

Metronome volume.

3 Use the dial to set the metronome volume as required.

Adjusting the Tempo

If a song or pattern seems to be too fast or slow, try changing the tempo.

Press the TEMPO [+] or [-] button.

The “Tempo” parameter will appear in the display.

Use the TEMPO [+] and [-] buttons to set the tempo to anywhere from 11 through 280 beats per minute.

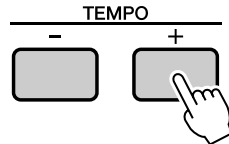

You can return to the original tempo by simultaneously pressing the [+] and [-] buttons.

Using the TAP TEMPO Button

For songs in 4/4 time tap the [TAP TEMPO] button four times, or for 3/4 songs tap it 3 times at the desired tempo to automatically set the playback tempo accordingly.

Tap slowly to reduce the tempo, or quickly to increase the tempo. You only need to tap twice to set the tempo during song playback.

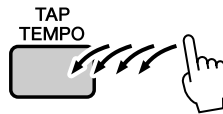

Setting the Touch Response

When touch response is on you can adjust the keyboard's sensitivity to dynamics in four steps.

- 1 Press the [UTILITY] button to go to the UTILITY display.

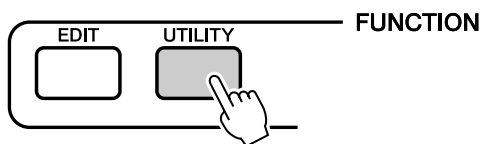

- 2 Use the CATEGORY [DEC] / [INC] buttons to select the Touch Sensitivity item.

The currently selected touch sensitivity is displayed.

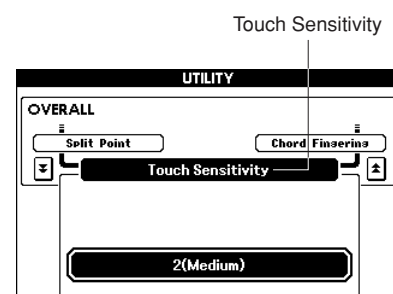
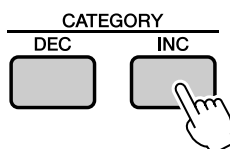

- 3 Use the dial to select a touch sensitivity setting between 1 and 4.

Higher values produce greater (easier) volume variation in response to keyboard dynamics—i.e. greater sensitivity.

When touch sensitivity is set to 4 (Off), all notes will be played at the same volume no matter how hard or softly you play the keys.

NOTE

- The initial default touch sensitivity setting is “2”.

Select a Master EQ Setting for the Best Sound

Five different Master EQ settings are provided, giving you the best possible sound in a range of different situations.

1 Press the [UTILITY] button to go to the UTILITY display.

The currently selected function will appear in the display.

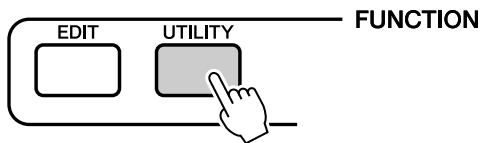

2 Use the CATEGORY [DEC] / [INC] buttons to select the Master EQ Type item.

The currently selected EQ type will appear.

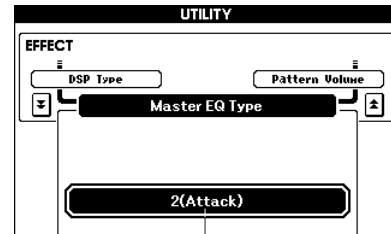
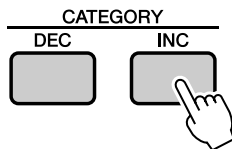

The Currently Selected Master EQ Type

3 Use the dial to select the desired Master EQ setting.

Five settings are available: 1 through 5. Settings are provided that boost the lows, reduce the frequency range for special effects, and more.

Controlling Arpeggio Volume with Keyboard Dynamics

1 Press the [UTILITY] button to go to the UTILITY display.

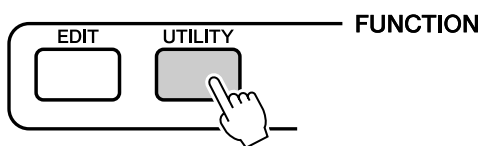

2 Use the CATEGORY [DEC] / [INC] buttons to select the Arpeggio Velocity item.

The currently selected arpeggio velocity is displayed.

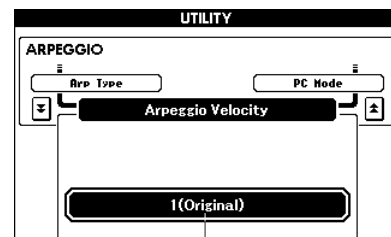
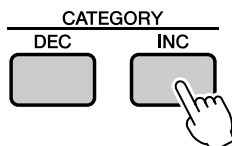

The Currently Selected Arpeggio Velocity

3 Use the dial to set the velocity as required.

Original .. The selected velocity is used for playback of each arpeggio type.
Thru..... The actual keyboard velocity is used.

Transpose the Keyboard

◆ Pitch Changes in Semitone Increments (Transpose)

The overall pitch of the instrument can be shifted up or down by a maximum of one octave in semitone increments.

- 1 Press one of the TRANSPOSE [+] / [-] buttons. The value is shown in the display, indicating the amount of transposition over or below the normal value.

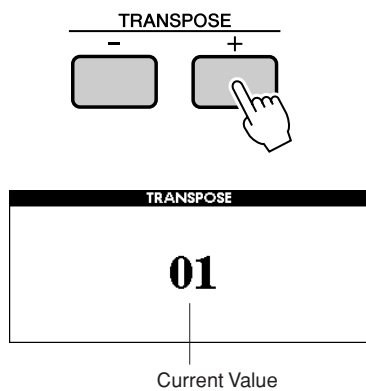

- 2 Use the dial to set the transpose value between -12 and +12 as required.

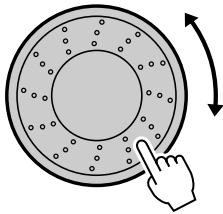

NOTE

• This setting does not affect Drum Kit Voices.

Press the [EXIT] button to return to the MAIN display.

Pressing the TRANSPOSE [+] / [-] buttons briefly allows single-step changes.

Pressing and holding either TRANSPOSE [+] / [-] button continuously increases or decreases the value.

NOTE

• Press either the [INC/YES] and [DEC/NO] buttons or TRANSPOSE [+] and [-] buttons simultaneously to recall the initial default value.

◆ Fine Pitch Changes (Tuning)

The overall tuning of the instrument can be shifted up or down by a maximum of 1 semitone in approximately 0.2-Hz steps. The default setting is 440Hz.

- 1 Press the [UTILITY] button to go to the UTILITY display.

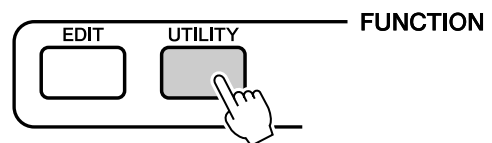

- 2 Use the CATEGORY [DEC] / [INC] buttons to select the Tuning item.

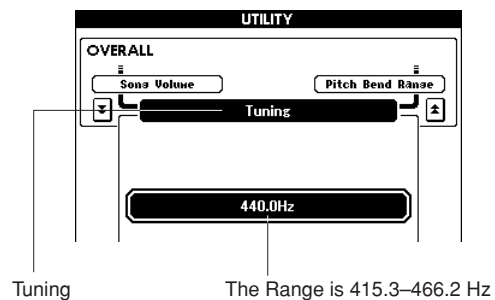

- 3 Use the dial to set the tuning value between 415.3 and 466.2Hz as required.

NOTE

• This setting does not affect Drum Kit Voices.

NOTE

• Press the [INC/YES][DEC/NO] buttons simultaneously to instantly reset to the default setting.

Shifting Keyboard Pitch in Octaves

Sometimes you may wish to play in a lower or higher pitch range. For example, you may want to shift the pitch down to get extra bass notes, or up to get higher notes for leads and solos. The OCTAVE [UP] / [DOWN] buttons let you do this quickly and easily.

Each time you press the OCTAVE [UP] button on the panel, the overall pitch of the voice goes up by one octave. Press the OCTAVE [DOWN] button to shift the keyboard pitch down one octave. The range is from -1 to +1, with 0 being standard pitch.

When the octave is shifted up the OCTAVE [UP] button indicator lights, and when shifted down the OCTAVE [DOWN] button indicator lights.

You can instantly restore standard pitch (0) by simultaneously pressing both the OCTAVE [UP] and [DOWN] buttons (both indicators go out).

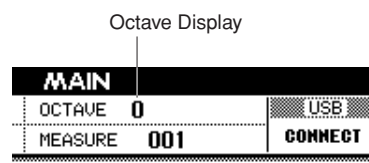
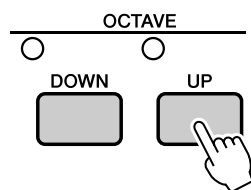

● OCTAVE +1

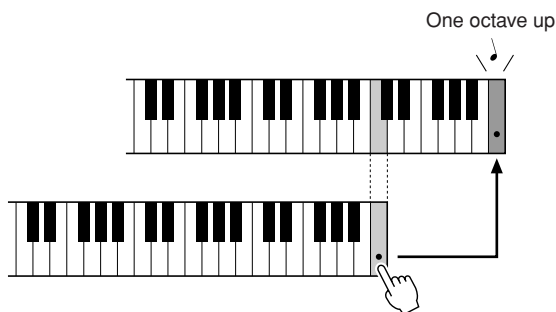

● OCTAVE -1

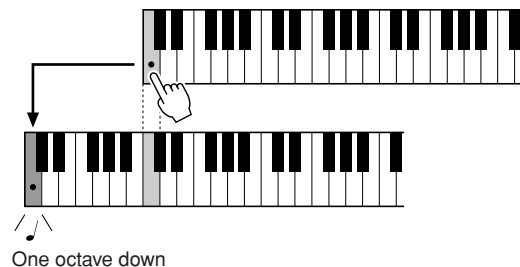

NOTE

- When a Drum Kit is selected, the percussion voices assigned to the keyboard are shifted in location but not pitch.

Pattern Functions

Basic operation of the Pattern (auto-accompaniment) feature is described on page 22. Here are some other ways you can play the patterns, pattern volume adjustment procedure, how you can play chords using the patterns, and more.

Pattern Variations (Sections)

To provide some variation for pattern playback, each pattern includes a number of “sections” that can be selected and played as required.

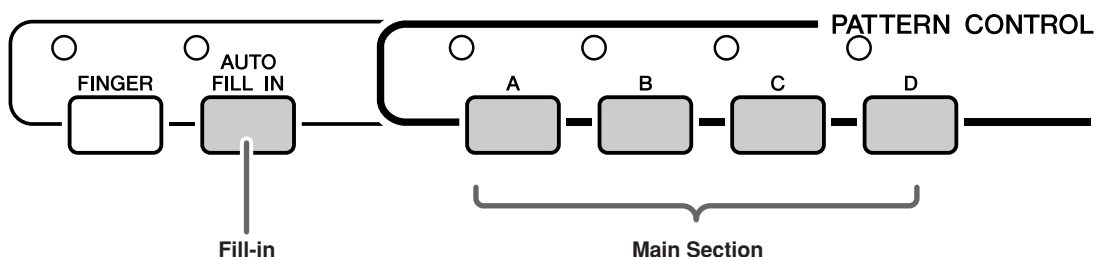

● Main sections A–D

These are the main accompaniment patterns that repeat indefinitely until another section is selected.

When the [FINGER] button is engaged the pattern will play back with chords determined by what you play with the left hand.

● Fill Ins (AUTO FILL IN)

Press the [AUTO FILL IN] button to turn the automatic fill-in function on. When this function is on fill-ins will automatically be added to the pattern rhythm part when the main sections are switched.

Even when the automatic fill in function is off you can add a fill-in at any time by simply pressing a main section button while that same section is playing.

1 Select the desired pattern. (See page 22)

2 Turn the pattern on.

Press the [FINGER] button. The indicator to the upper left of the button will light.

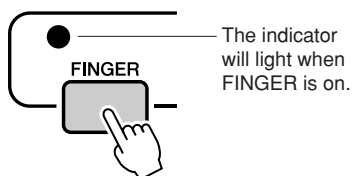

3 Turn AUTO FILL IN on.

Press the [AUTO FILL IN] button.

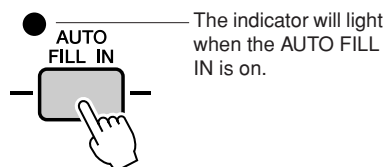

4 Press the [SYNC START] button to turn Sync Start on.

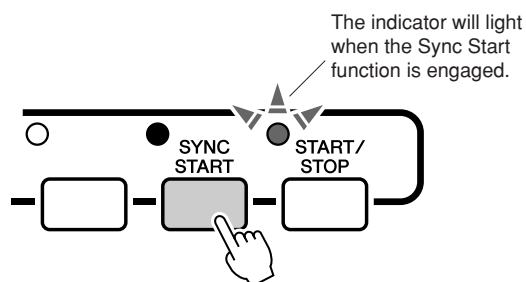

● Sync Start

When the Sync Start standby mode is engaged, pattern playback will begin as soon as you play a chord in the accompaniment range of the keyboard.

5 Press a main section button: [A]–[D].

The indicator to the upper left of the active main section button will light.

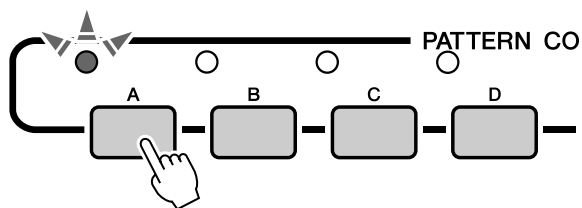

6 The main section of the selected pattern will start as soon as you play a chord with your left hand.

For this example, play a C major chord (as shown below).

For information on how to enter chords, see “Playing Auto-accompaniment Chords” on page 25.

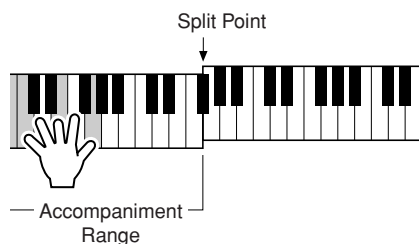

7 Press any of the main section buttons, [A]–[D], as required.

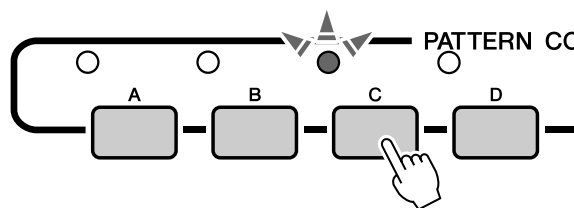

A fill-in will play, leading smoothly to the selected main section.

Setting the Split Point

The initial default split point is key number 54 (the F#2 key), but you can change it to another key using the procedure described below.

1 Press the [UTILITY] button to go to the UTILITY display.

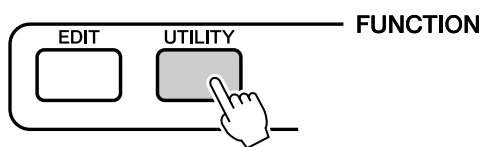

2 Use the CATEGORY [DEC] / [INC] buttons to select the Split Point item.

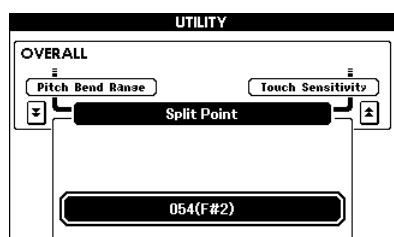
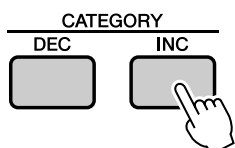

3 Use the dial to set the split point to any key from 000 (C-2) through 127 (G8).

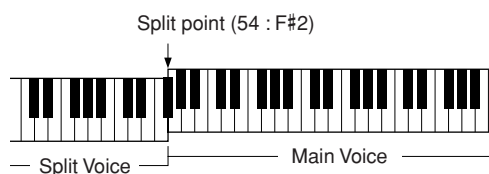

NOTE

- When you change the split point the auto-accompaniment split point also changes.
- The split voice sounds when the split-point key is played.

Play a Pattern with Chords but No Rhythm (Stop Accompaniment)

After pressing the [FINGER] button to turn auto-accompaniment on, you can play in the left-hand (accompaniment) area of the keyboard to produce chords without rhythm accompaniment. This is “Stop Accompaniment”, and any of the chord fingerings recognized by the instrument can be used. The MM6/MM8 recognizes keys played in the auto accompaniment section of the keyboard as chords (page 25).

Select a pattern (page 22) and engage the pattern mode, then press the [FINGER] button to turn the FINGER mode on.

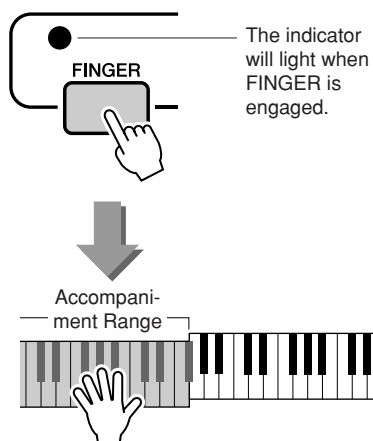

Pattern Volume Adjustment

Select a pattern (page 22) and engage the pattern mode.

1 Press the [UTILITY] button to go to the UTILITY display.

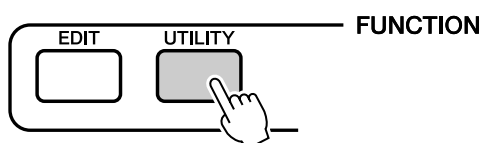

2 Use the CATEGORY [DEC] / [INC] buttons to select the Pattern Volume item.

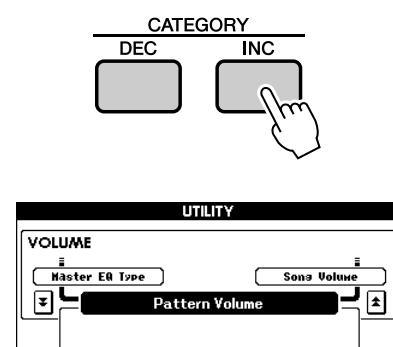

3 Use the dial to set the pattern volume between 000 and 127.

Chord Basics

Two or more notes played together constitute a “chord”.

The most basic chord type is the “triad” consisting of three notes: the root, third, and fifth degrees of the corresponding scale. A C major triad, for example, is made up of the notes C (the root), E (the third note of the C major scale), and G (the fifth note of the C major scale).

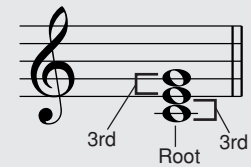

In the C major triad shown above, the lowest note is the “root” of the chord (this is the chord’s “root position” ... using other chord notes for the lowest note results in “inversions”). The root is the central sound of the chord, which supports and anchors the other chord notes. The distance (interval) between adjacent notes of a triad in root position is either a major or minor third.

Major third—four half steps (semitones)

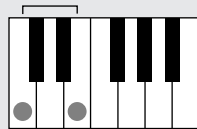

Minor third—three half steps (semitones)

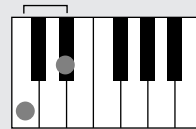

The lowest interval in our root-position triad (between the root and the third) determines whether the triad is a major or minor chord, and we can shift the highest note up or down by a semitone to produce two additional chords, as shown below.

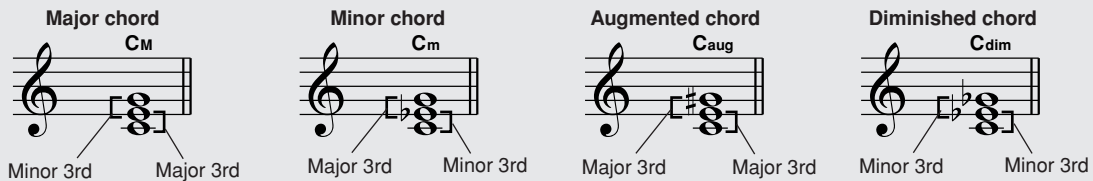

The basic characteristics of the chord sound remain intact even if we change the order of the notes to create different inversions. Successive chords in a chord progression can be smoothly connected, for example, by choosing the appropriate inversions (or chord “voicings”).

● Reading Chord Names

Chord names tell you just about everything you need to know about a chord (other than the inversion/voicing). The chord name tells you what the root of the chord is, whether it is a major, minor, or diminished chord, whether it requires a major or flatted seventh, what alterations or tensions it uses ... all at a glance.

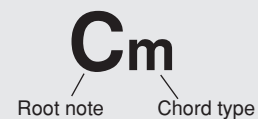

● Some Chord Types (These are just some of the “Standard” chord types recognized by the MM6/MM8.)

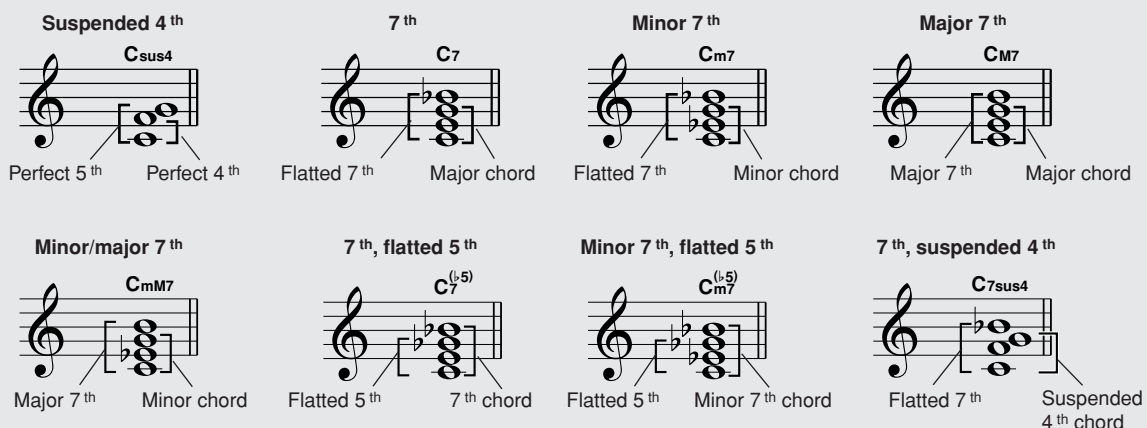

■ Recognized Standard Chords.....

All chords in the chart are “C-root” chords.

Chord Name/[Abbreviation]	Normal Voicing	Chord (C)	Display
Major [M]	1 - 3 - 5	C	C
Add ninth [(9)]	1 - 2 - 3 - 5	C ⁽⁹⁾	Cadd9
Sixth [6]	1 - (3) - 5 - 6	C ₆	C6
Sixth ninth [6(9)]	1 - 2 - 3 - (5) - 6	C ₆ ⁽⁹⁾	C6 ⁹
Major seventh [M7]	1 - 3 - (5) - 7	CM7	CM7
Major seventh ninth [M7(9)]	1 - 2 - 3 - (5) - 7	CM ₇ ⁽⁹⁾	CM7 ⁹
Major seventh add sharp eleventh [M7(#11)]	1 - (2) - 3 - #4 - 5 - 7 or 1 - 2 - 3 - #4 - (5) - 7	CM ₇ ^(#11)	CM7#11
Flatted fifth [(b5)]	1 - 3 - b5	C ^(b5)	C ^{b5}
Major seventh flatted fifth [M7b5]	1 - 3 - b5 - 7	CM ₇ ^(b5)	CM7 ^{b5}
Suspended fourth [sus4]	1 - 4 - 5	C _{sus4}	Csus4
Augmented [aug]	1 - 3 - #5	C _{aug}	Caug
Major seventh augmented [M7aug]	1 - (3) - #5 - 7	CM _{7aug}	CM7aug
Minor [m]	1 - b3 - 5	C _m	Cm
Minor add ninth [m(9)]	1 - 2 - b3 - 5	C _m ⁽⁹⁾	Cm add9
Minor sixth [m6]	1 - b3 - 5 - 6	C _{m6}	Cm6
Minor seventh [m7]	1 - b3 - (5) - b7	C _{m7}	Cm7
Minor seventh ninth [m7(9)]	1 - 2 - b3 - (5) - b7	C _{m7} ⁽⁹⁾	Cm7 ⁹
Minor seventh add eleventh [m7(11)]	1 - (2) - b3 - 4 - 5 - (b7)	C _{m7} ⁽¹¹⁾	Cm7 ¹¹
Minor major seventh [mM7]	1 - b3 - (5) - 7	C _{mM7}	CmM7
Minor major seventh ninth [mM7(9)]	1 - 2 - b3 - (5) - 7	C _{mM7} ⁽⁹⁾	CmM7 ⁹
Minor seventh flatted fifth [m7b5]	1 - b3 - b5 - b7	C _{m7} ^(b5)	Cm7 ^{b5}
Minor major seventh flatted fifth [mM7b5]	1 - b3 - b5 - 7	C _{mM7} ^(b5)	CmM7 ^{b5}
Diminished [dim]	1 - b3 - b5	C _{dim}	Cdim
Diminished seventh [dim7]	1 - b3 - b5 - 6	C _{dim7}	Cdim7
Seventh [7]	1 - 3 - (5) - b7 or 1 - (3) - 5 - b7	C ₇	C7
Seventh flatted ninth [7(b9)]	1 - b2 - 3 - (5) - b7	C ₇ ^(b9)	C7 ^{b9}
Seventh add flatted thirteenth [7(b13)]	1 - 3 - 5 - b6 - b7	C ₇ ^(b13)	C7 ^{b13}
Seventh ninth [7(9)]	1 - 2 - 3 - (5) - b7	C ₇ ⁽⁹⁾	C7 ⁹
Seventh add sharp eleventh [7(#11)]	1 - (2) - 3 - #4 - 5 - b7 or 1 - 2 - 3 - #4 - (5) - b7	C ₇ ^(#11)	C7#11
Seventh add thirteenth [7(13)]	1 - 3 - (5) - 6 - b7	C ₇ ⁽¹³⁾	C7 ¹³
Seventh sharp ninth [7(#9)]	1 - #2 - 3 - (5) - b7	C ₇ ^(#9)	C7#9
Seventh flatted fifth [7b5]	1 - 3 - b5 - b7	C _{7b5}	C7 ^{b5}
Seventh augmented [7aug]	1 - 3 - #5 - b7	C _{7aug}	C7aug
Seventh suspended fourth [7sus4]	1 - 4 - (5) - b7	C _{7sus4}	C7sus4
Suspended second [sus2]	1 - 2 - 5	C _{sus2}	Csus2

NOTE

- Notes in parentheses can be omitted.
- Playing two same root keys in the adjacent octaves produces accompaniment based only on the root.
- A perfect fifth (1 + 5) produces accompaniment based only on the root and fifth which can be used with both major and minor chords.
- The chord fingerings listed are all in “root” position, but other inversions can be used—with the following exceptions: m7, m7b5, 6, m6, sus4, aug, dim7, 7b5, 6(9), sus2.

NOTE

- Inversion of the 7sus4 and m7(11) chords are not recognized if the notes shown in parentheses are omitted.
- The auto accompaniment will sometimes not change when related chords are played in sequence (e.g. some minor chords followed by the minor seventh).
- Two-note fingerings will produce a chord based on the previously played chord.
- Some chords may not be recognized depending on the selected pattern.

Specify Chords Over the Entire Keyboard Range

In “Play Along with a Pattern” on page 23 we described two methods of playing Patterns (Multi, Full Keyboard) in which chords were either detected only to the left of the keyboard split point or over the entire keyboard.

By making the settings described below, chord detection for pattern accompaniment occurs over the entire range of the keyboard. Since you can also play normally over the entire keyboard range at the same time, this capability makes it possible to create complex and interesting performances.

In this mode only chords played in the normal way (page 25) can be detected.

- 1 Press and hold the [FINGER] button for longer than a second so that the Chord Fingering item appears.**

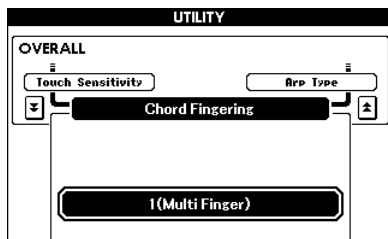
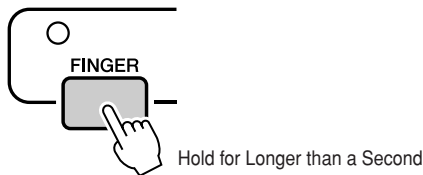

- 2 Use the dial to select 2 (FullKeyboard).**

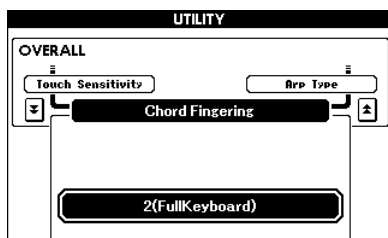
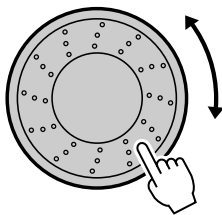

Song Settings

Song Volume

- 1 Press the [UTILITY] button to go to the UTILITY display.

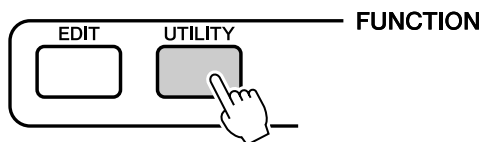

- 2 Use the CATEGORY [DEC] / [INC] buttons to select the Song Volume item.

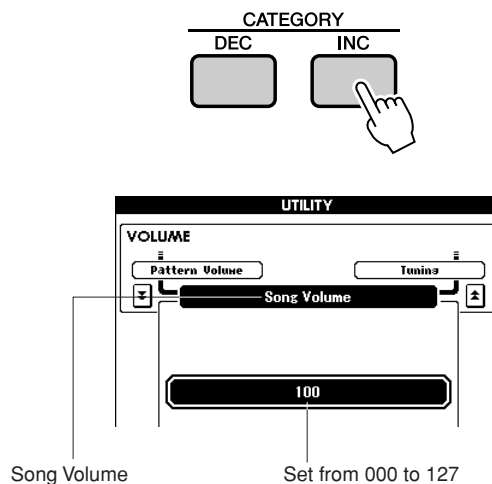

- 3 Use the dial to set the Song volume as required.

NOTE

• Song volume can be adjusted while a song is selected.

Change the Song Tempo

You can change the song playback tempo as required.

Press the TEMPO [+] or [-] button. The tempo display will appear and you can use the dial or the TEMPO [+] / [-] buttons to set to tempo to anywhere from 011 and 280 quarter-note beats per minute.

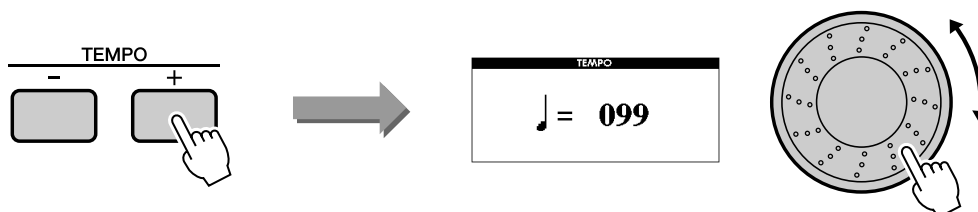

You can return to the original tempo by simultaneously pressing the [+] and [-] buttons. Press the [EXIT] button when you have finished making the required settings. Pressing and holding either button continuously increases or decreases the tempo.

Track Mute

Each “track” plays a different part of the song—melody, percussion, accompaniment, etc. You can mute individual tracks and play the muted part on the keyboard yourself, or simply mute tracks other than the ones you want to listen to.

To mute a track, press the appropriate track button (TRACK [1]–[8], [PATTERN]) while holding the [TRACK SELECT/MUTE] button.

Press the same button a second time to disengage track muting.

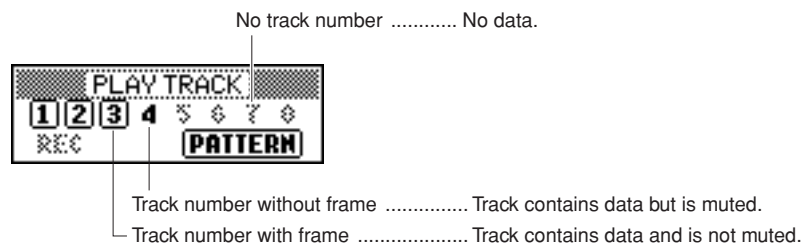
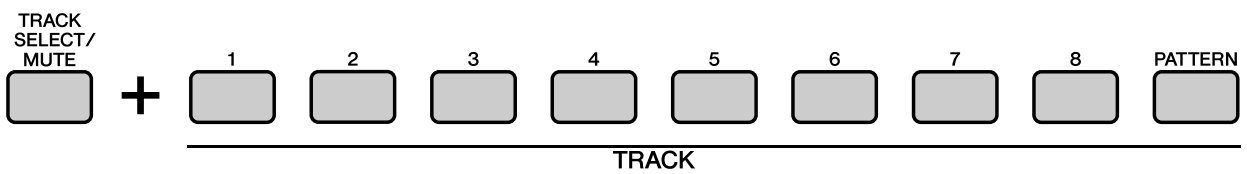

Memorize Your Favorite Panel Settings

This instrument has a **PERFORMANCE MEMORY** feature that lets you save up to 64 of your favorite settings for easy recall whenever they're needed.

Up to 64 complete setups can be saved (8 x 8 banks).

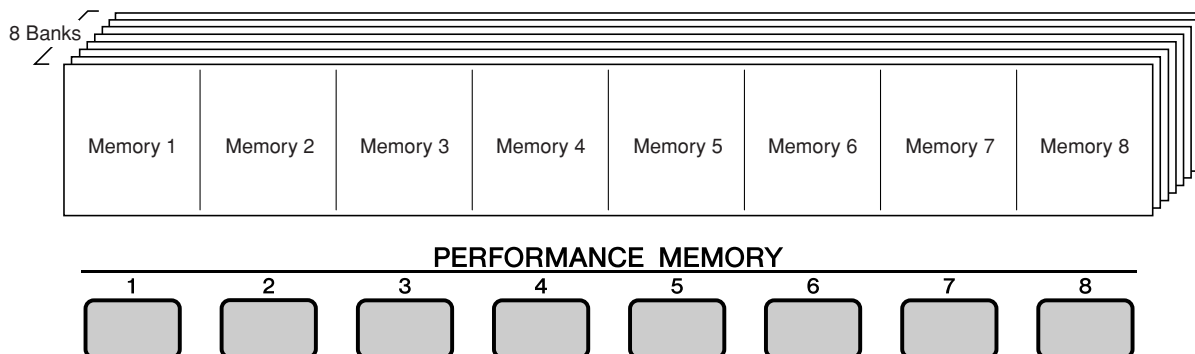

Saving to the Performance Memory

- 1 Set the panel controls as required—select a voice, pattern, etc.
- 2 Press the **PERFORMANCE BANK [INC] / [DEC]** buttons until the desired bank number is shown on the display. You can also use the dial in the **PERFORMANCE BANK** display.

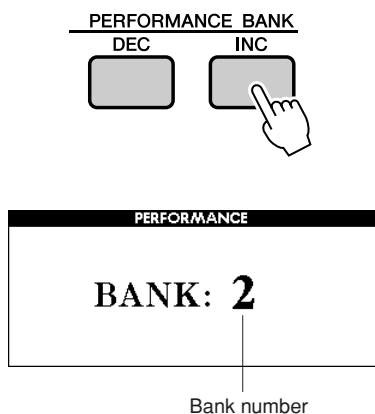

NOTE

- Data cannot be saved to the performance memory during song playback.

- 3 Press the **PERFORMANCE MEMORY [1]–[8]** button while holding down the **[STORE]** button.

This saves the current panel settings in the instrument's memory.

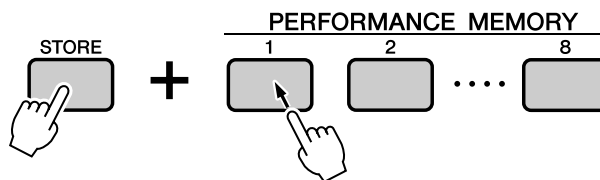

NOTE

- You can also save panel settings that have been saved to the Performance Memory to a USB storage device as a user file (see page 69).

NOTE

- If you save to a Performance Memory number that already contains data, the previous data is deleted and overwritten by the new data.

CAUTION

- Do not turn off the power while saving settings to the Performance Memory, otherwise the data may be damaged or lost.

Recalling Settings from the Performance Memory

1 Press the PERFORMANCE BANK [INC] / [DEC] buttons until the desired bank number is shown on the display.

You can also use the dial in the PERFORMANCE BANK display.

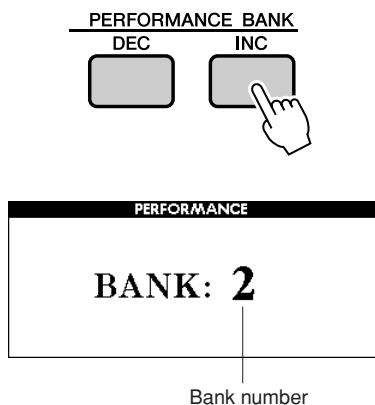

2 Press the PERFORMANCE MEMORY button, [1]–[8], containing the settings you want to recall.

The panel controls will be instantly set accordingly.

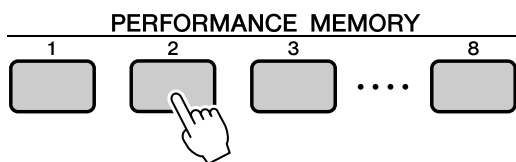

● Settings That Can be Saved to the Performance Memory

• Pattern settings

Pattern number, FINGER ON/OFF, Split Point, Pattern settings (Main A/B/C/D), Pattern volume, Tempo, Chord Fingering, Sync Start ON/OFF

• Voice settings

Main Voice setting

Voice number, Volume, Octave, Pan, Reverb Level, Chorus Level, DSP Send Level, DRY Level, Attack Time, Release Time, Filter Cutoff, Filter resonance

Dual Voice setting

Dual ON/OFF, Voice number, Volume, Octave, Pan, Reverb Level, Chorus Level, DSP Send Level, DRY Level, Attack Time, Release Time, Filter Cutoff, Filter resonance

Split Voice setting

Split ON/OFF, Voice number, Volume, Octave, Pan, Reverb Level, Chorus Level, DSP Send Level, DRY Level

• Effect settings

Reverb Type, Chorus Type, DSP ON/OFF, DSP Type

• Other settings

Transpose, Pitch Bend Range, Arpeggio ON/OFF, Arpeggio Type, Octave

Erase a Performance Memory

This procedure erases the panel settings saved in a performance memory.

- 1** The PERFORMANCE BANK display will appear when you press the PERFORMANCE BANK [INC] or [DEC] button. Use the PERFORMANCE BANK [INC] and [DEC] buttons to select the bank containing the performance memory you want to erase.

While the PERFORMANCE BANK display is showing you can also use the dial to select a bank.

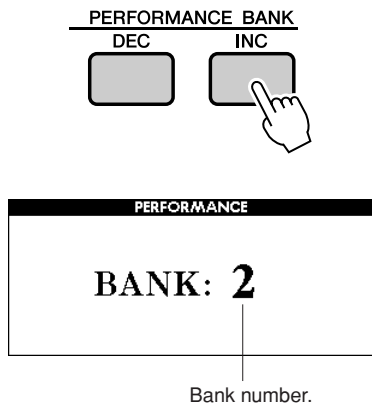

- 2** Press and hold the PERFORMANCE MEMORY button ([1]–[8]) corresponding to the Performance you want to clear for longer than a second.

A confirmation message will appear on the display.

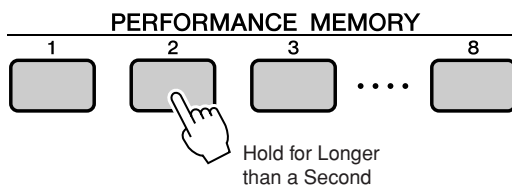

- 3** Press the [INC/YES] button.

A confirmation message will appear on the display.

Press [DEC/NO] if you want to cancel the operation.

- 4** To execute the Performance Memory erase function press the [INC/YES] button.

The clear-in-progress message will appear briefly on the display while the data is being erased.

Voice Editing

Create original voices by editing the many available voice parameters. By editing the various parameters available you can create new voices that best suit your musical needs.

Select and Edit an Item

There are 21 editable parameters.

1 Find the function you want to set in the EDIT display list that begins on page 63.

2 Press the [EDIT] button to enter the EDIT display.

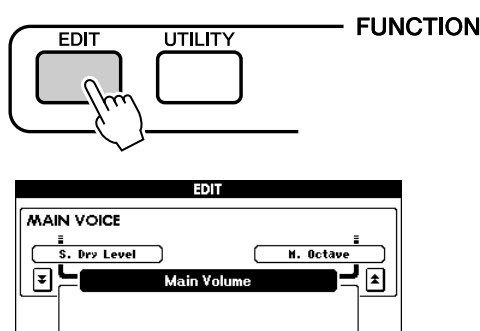

3 Each time the CATEGORY [INC] / [DEC] buttons are pressed the 21 available items are selected in sequence. Select the item you want to edit.

Refer to the function settings list on page 63 for information on the items that can be edited. The previous item will be displayed in the upper left area of the display, while the next item will be displayed in upper right area of the display.

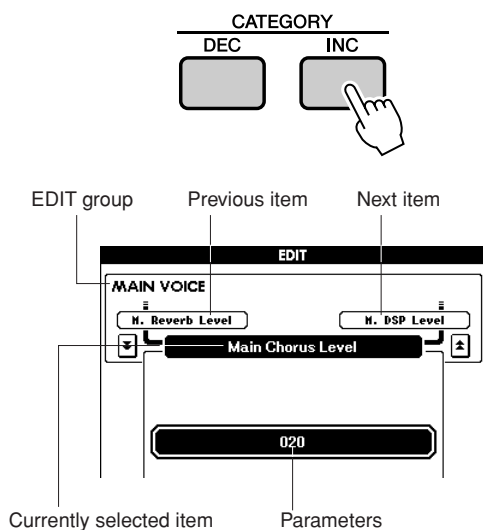

4 Use the dial or [DEC/NO] and [INC/YES] buttons to set the value.

Press the [INC/YES][DEC/NO] buttons simultaneously to instantly reset to the default setting.

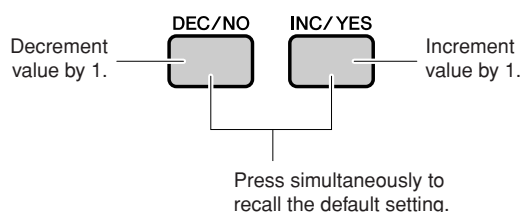

Edited parameters can be saved to performance memory (page 59).

■ Edit Display List

Group	Function Item	Display Indication	Range/Settings	Description
MAIN VOICE	Volume	Main Volume	000–127	Determines the volume of the Main Voice.
	Octave	Main Octave	-2–2	Determines the octave of the Main Voice in octave increments.
	Pan	Main Pan	000 (left)– 064 (center)– 127 (right)	Determines the pan position of the Main Voice. “0” results in the sound being panned full left; “127” results in the sound being panned full right.
	Reverb Level	Main Reverb Level	000–127	Determines how much of the Main Voice signal is sent to the Reverb effect.
	Chorus Level	Main Chorus Level	000–127	Determines how much of the Main Voice signal is sent to the Chorus effect.
	DSP Level	Main DSP Level	000–127	Determines how much of the Main Voice signal is sent to the DSP effect.
	Dry Level	Main Dry Level	000–127	Determines how much of the unprocessed Main Voice signal is heard (without Reverb, Chorus or DSP effect processing).
DUAL VOICE	Volume	Dual Volume	000–127	Determines the volume of the Dual Voice.
	Octave	Dual Octave	-2–2	Determines the octave range for the Dual Voice in octave increments.
	Pan	Dual Pan	000 (left)– 064 (center)– 127 (right)	Determines the pan position of the Dual Voice. “0” results in the sound being panned full left; “127” results in the sound being panned full right.
	Reverb Level	Dual Reverb Level	000–127	Determines how much of the Dual Voice signal is sent to the Reverb effect.
	Chorus Level	Dual Chorus Level	000–127	Determines how much of the Dual Voice signal is sent to the Chorus effect.
	DSP Level	Dual DSP Level	000–127	Determines how much of the Dual Voice signal is sent to the DSP effect.
	Dry Level	Dual Dry Level	000–127	Determines how much of the unprocessed Dual Voice signal is heard (without Reverb, Chorus or DSP effect processing).
SPLIT VOICE	Volume	Split Volume	000–127	Determines the volume of the Split Voice.
	Octave	Split Octave	-2–2	Determines the octave range of the Split Voice in octave increments.
	Pan	Split Pan	000 (left)– 064 (center)– 127 (right)	Determines the pan position of the Split Voice. “0” results in the sound being panned full left; “127” results in the sound being panned full right.
	Reverb Level	Split Reverb Level	000–127	Determines how much of the Split Voice signal is sent to the Reverb effect.
	Chorus Level	Split Chorus Level	000–127	Determines how much of the Split Voice signal is sent to the Chorus effect.
	DSP Level	Split DSP Level	000–127	Determines how much of the Split Voice signal is sent to the DSP effect.
	Dry Level	Split Dry Level	000–127	Determines how much of the unprocessed Split Voice signal is heard (without Reverb, Chorus or DSP effect processing).

* Press the [INC/YES][DEC/NO] buttons simultaneously to instantly reset to the default settings.

Utility Settings

Detailed settings such as tuning, split point, and effects can be made via the UTILITY screen.

Selecting and Setting Functions

There are 25 function parameters in all.

1 Find the function you want to set in the UTILITY display list that begins on page 65.

2 Press the [UTILITY] button to go to the UTILITY display.

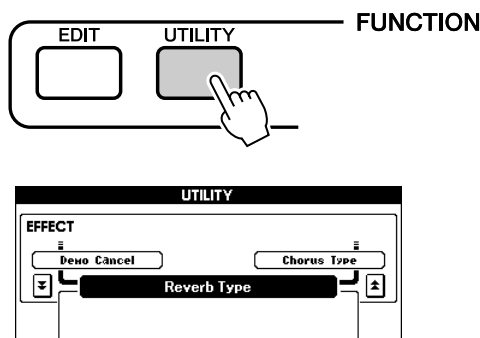

3 Press the CATEGORY [DEC] and [INC] buttons as many times as necessary until the function's display name appears in the display.

Refer to the function list on page 65. The name of the previous item in the list appears to the upper left, and the name of the next item in the list appears to the upper right of the currently selected item.

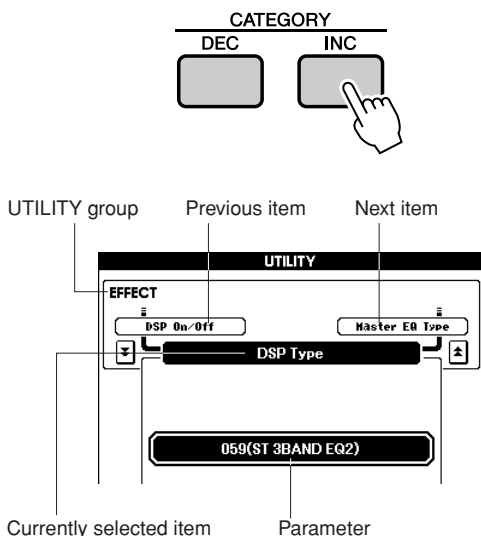

4 Use the dial or [DEC/NO] and [INC/YES] buttons to set the value.

On/off type settings can be turned ON by pressing the [INC/YES] button, and OFF by pressing the [DEC/NO] button. In some cases the [INC/YES] button will initiate execution of the selected function, and the [DEC/NO] will cancel the selection. Press the [INC/YES][DEC/NO] buttons simultaneously to instantly reset to the default settings (except for initial MIDI setup).

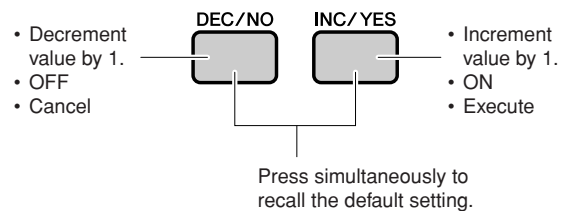

Utility settings are memorized as soon as they are changed. However, items saved to the performance memory are saved as performance data.

To restore all initial factory default settings perform the "Backup Clear" procedure described in the "Initialization" section on page 35.

■ Utility Display List

Group	Function Item	Display Indication	Range/Settings	Description
EFFECT	Reverb Type	Reverb Type	01–26	Determines the Reverb type, “26” is “off”. (See the list on page 100)
	Chorus Type	Chorus Type	01–31	Determines the Chorus type. “31” is “off”. (See the list on page 100)
	DSP On/Off	DSP On/Off	ON/OFF	Sets the equalizer applied to the instrument output (including headphones or other output) for optimum sound in different listening situations.
	DSP Type	DSP Type	001–190	Determines the DSP type. “190” is “off”. (See the list on page 101).
	Master EQ Type	Master EQ Type	1 (Flat), 2 (Attack), 3 (Hard), 4 (Retro), 5 (HighPass)	Selects the Master EQ type. Use this feature to boost the bass, reduce the reproduction range for special effects, and more.
VOLUME	Pattern Volume	Pattern Volume	000–127	Determines the volume of pattern playback.
	Song Volume	Song Volume	000–127	Determines the volume of song playback.
OVERALL	Tuning	Tuning	415.3–466.2 Hz	Sets the pitch of the instrument’s sound in approximately 0.2 Hertz increments.
	Pitch Bend Range	Pitch Bend Range	01–12	Sets the pitch bend range in semitone increments.
	Split Point	Split Point	000–127(C-2–G8)	Determines the highest key for the Split voice and sets the Split “point”—in other words, the key that separates the Split (lower) and Main (upper) voices. The Split Point and Accompaniment Split Point settings are automatically set to the same value.
	Touch Sensitivity	Touch Sensitivity	1 (Soft), 2 (Medium), 3 (Hard), 4 (off)	Determines the sensitivity of the feature.
	Chord Fingering	Chord Fingering	1 (Multi Finger), 2 (FullKeyboard)	Sets the chord detection mode. In the Multi Finger mode both normal chords and simple chords played to the left of the split point are detected. In the Full keyboard mode normal chords played anywhere on the keyboard will be detected, and notes played normally will sound as well.
ARPEGGIO	Arpeggio Type	Arpeggio Type	01–150	Selects the arpeggio type. Refer to the arpeggio list on page 104.
	Arpeggio Velocity	Arpeggio Velocity	1 (Original), 2 (Thru)	Sets the arpeggio volume.
PC MODE	PC Mode	PC Mode	ON/OFF	Optimizes the MIDI settings for connecting to a computer (page 79).
MIDI	Local On/Off	Local	ON/OFF	Local control determines whether or not notes played on the instrument are sounded by its internal tone generator system: the internal tone generator is active when local control is on, and inactive when local control is off. (page 78)
	External Clock On/Off	External Clock	ON/OFF	These settings determine whether the instrument is synchronized to its own internal clock (OFF), or to a clock signal from an external device (ON). (page 78)
	Keyboard Out	Keyboard Out	ON/OFF	These settings determine whether keyboard performance data is transmitted via the MIDI output (ON) or not (OFF).
	Pattern Out	Pattern Out	ON/OFF	Determines whether pattern data will be output via the MIDI output (ON) or not (OFF) during pattern playback.
	Song Out	Song Out	ON/OFF	Determines whether song data will be output via the MIDI output (ON) or not (OFF) during song playback.
	Initial Setup	Initial Setup	YES/NO	Sends the instrument’s panel data to a computer. Press [INC/YES] to send, or press [DEC/NO] to cancel.
METRONOME	Time Signature – Numerator	Time Signature – Numerator	00–60	Determines the time signature of the metronome.
	Time Signature – Denominator	Time Signature – Denominator	2, 4, 8, 16	Sets the length of each metronome beat.
	Volume	Metronome Volume	000–127	Determines the volume of the metronome.
UTILITY	Demo Cancel	Demo Cancel	ON/OFF	When ON, demo playback will not start even if the [SONG] and [PATTERN] buttons are pressed simultaneously.

* Press the [INC/YES][DEC/NO] buttons simultaneously to instantly recall the default settings (except for initial MIDI setup).

Storing/Saving Data

In this section we'll look at the procedures for setting up and formatting USB storage devices, as well as for saving and loading data to and from them.

A USB storage device is a large-volume memory medium used for storing data.

When a USB storage device is inserted in this instrument's USB TO DEVICE terminal, user songs created on the instruments and memorized settings can be saved to or loaded from the device.

A USB storage device can also be used to transfer song data downloaded from the Internet to the instrument.

If you don't have a USB storage device, you will need to purchase one (or more, as needed).

The instrument does not necessarily support all commercially available USB storage devices. Yamaha cannot guarantee operation of USB storage devices that you purchase. Before purchasing a USB storage device, please consult your Yamaha dealer, or an authorized Yamaha distributor (see list at end the Owner's Manual) for advice.

● To protect your data (write-protect switch)

Some USB storage devices are equipped with a write-protect switch.

To prevent accidental erasure of important data saved on a USB storage device, slide the write-protect switch on the device to the "protect" position. When saving data, make sure that the write-protect switch is set to the "overwrite" position.

Using a USB Storage Device

1 Connect a USB storage device to the USB TO DEVICE terminal, being careful to insert it in the proper direction.

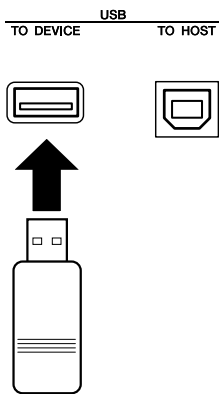

IMPORTANT

In order to play songs copied to a USB storage device from a computer or other device, the songs must be stored either in the USB storage device's root directory or a first-level/second-level folder in the root directory. Songs stored in these location can be selected and played as USB songs (page 26). Songs stored in third-level-folders created inside a second-level folder cannot be selected and played by this instrument.

USB Storage Device (Root)

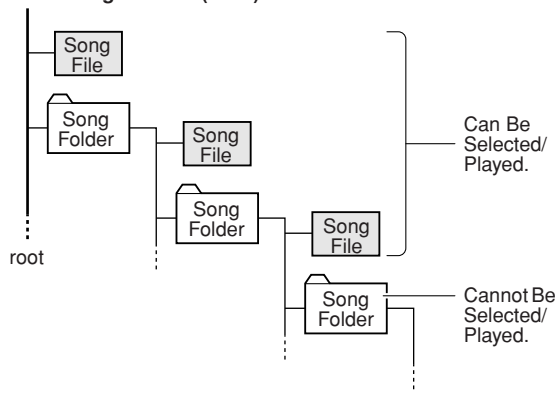

2 Check that “CONNECT” is showing in the MAIN display.

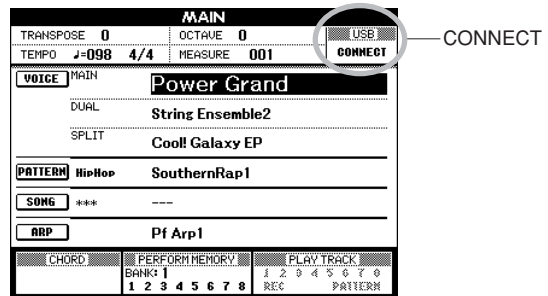

You can go to the FILE CONTROL display from which you can access USB storage device operations by pressing the [MENU] button from this display.

(Do not press this button now, but only when instructed to in the section below.)

Menu	Page
Format	68
User File Save	69
SMF Save	70
Load	71
Delete	72

A message (information or confirmation dialog) will sometimes appears on the display to facilitate operation. Refer to the “Messages” section on page 83 for explanations of each message.

NOTE

- No sound will be produced if you play the keyboard while FILE CONTROL display is showing. Also, in this state only buttons related to file functions will be active.

NOTE

- The FILE CONTROL display will not appear in any of the following cases:
 - During pattern or song playback
 - While data is being loaded from a USB storage device

Formatting a USB storage device

A new USB storage device must be formatted before it can be used by this instrument.

⚠ CAUTION

- If you format a USB storage device that already contains data, all of the data will be erased. Be careful not to erase important data when using the format function.

1 After connecting the USB storage device to be formatted to the instrument's USB TO DEVICE terminal, check that "CONNECT" is showing in the MAIN display.

2 Press the [MENU] button.

A message will appear asking you to confirm the format operation.

NOTE

- If the Load item appears in step 2, press the CATEGORY [INC] / [DEC] buttons as many times as necessary until the Format item appears.

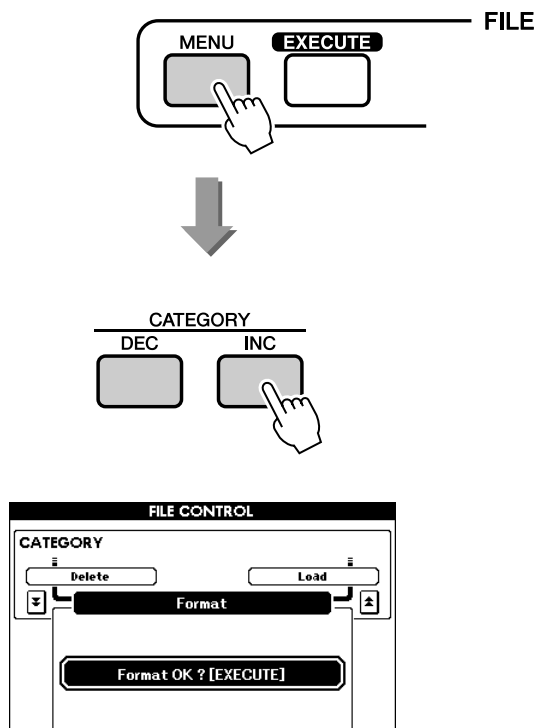

3 Press [EXECUTE] button and a confirmation message will appear.

You can press the [DEC/NO] button at this point to cancel the operation.

4 Press the [EXECUTE] button again, or the [INC/YES] button, and the format operation will begin.

⚠ CAUTION

- Once the format-in-progress message appears on the display the format operation cannot be canceled. Never turn off the power or remove the USB storage device during this operation.

5 A message will appear on the display when the operation is complete.

Press the [EXIT] button to return to the MAIN display.

NOTE

- If the USB storage device has been write-protected, an appropriate message will appear on the display and you will not be able to execute the operation.

Saving Data

Three types of data are saved to one “User File” by this operation: user song, pattern file, and performance memory data.

- 1** Make sure that a appropriately formatted USB storage device has been properly connected to the instrument’s USB TO DEVICE terminal, and that “CONNECT” is showing in the MAIN display.
- 2** Press the [MENU] button.
- 3** Use the CATEGORY [DEC] and [INC] buttons to locate the User File Save item.
A default file name will automatically be created.

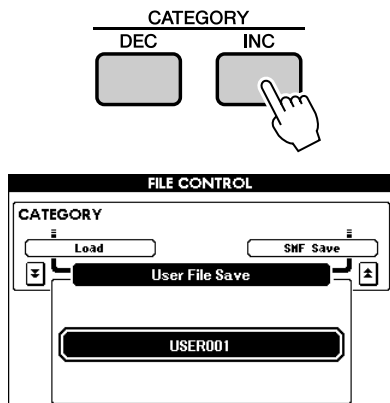

● To Overwrite an Existing File

If you want to overwrite a file that already exists on the USB storage device, use the dial or the [INC/YES] and [DEC/NO] buttons to select the file, then skip ahead to step 6.

NOTE

- If the USB storage device has been write-protected, an appropriate message will appear on the display and you will not be able to execute the operation.
- If there is not enough capacity left on the USB storage device to save the data, an appropriate message will appear on the display and you will not be able to save the data. Erase unwanted files from the USB storage device to make more memory available (page 72), or use a different USB device.
- Refer to the “Messages” list on page 83 for other possible errors that might prevent you from completing the operation.

4 Press the [EXECUTE] button.

A cursor will appear below the first character in the file name.

5 Change the file name as necessary.

- The [1] button moves the cursor to the left, and the [2] button moves it to the right.
- Use the dial to select a character for the current cursor location.
- The [8] button deletes the character at the cursor location.

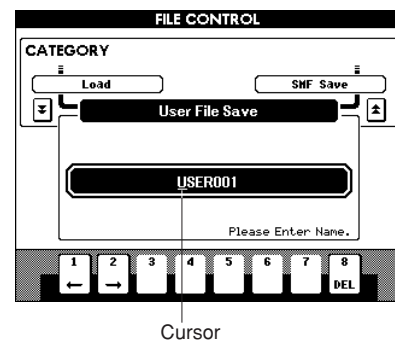
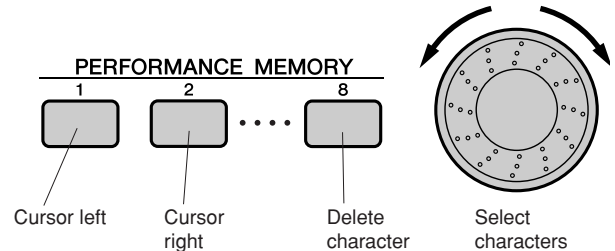

Settings for alphabetic and numeric characters:

A	B	C	D	E	F	G	H	I	J	K	L	M	N	O	P	Q	R	S	T
U	V	W	X	Y	Z	a	b	c	d	e	f	g	h	i	j	k	l	m	n
o	p	q	r	s	t	u	v	w	x	y	z	0	1	2	3	4	5	6	7
8	9	!	#	\$	%	&	'	()	-	^	@	{	}	-	`			

6 Press the [EXECUTE] button.

A confirmation message will appear on the display. You can press the [DEC/NO] button at this point to cancel the operation.

7 Press the [EXECUTE] button again, or the [INC/YES] button, and the save operation will begin.

The user file will be stored to the USER FILES folder in the USB storage device.

CAUTION

- Once the save-in-progress message appears in the display, the operation cannot be canceled. Never turn off the power or remove the USB storage device during this operation.

8 A message will appear on the display when the operation is complete.

Press the [EXIT] button to return to the MAIN display.

NOTE

- If an existing filename is specified you will be prompted for confirmation. Press [EXECUTE] or [INC/YES] if it is OK to overwrite the file, or [DEC/NO] to cancel.
- The amount of time it will take to perform the save operation depends on the particular USB storage device you are using.

Convert a User Song to SMF Format and Save

This operation converts a user song (song numbers 001–005) to SMF Format 0 and saves the file to a USB storage device.

● What is SMF (Standard MIDI File)?

The SMF (Standard MIDI File) format is one of the most common and widely compatible sequence formats used for storing sequence data. There are two variations: Format 0 and Format 1. A large number of MIDI devices are compatible with SMF Format 0, and most commercially available MIDI sequence data is provided in SMF Format 0.

1 Make sure that an appropriately formatted USB storage device has been properly connected to the instrument's USB TO DEVICE terminal, and that "CONNECT" is showing in the MAIN display.

2 Press the [MENU] button.

3 Use the CATEGORY [DEC] and [INC] buttons to locate the SMF Save item.

The SOURCE FILE field be highlighted and the user song name will be displayed.

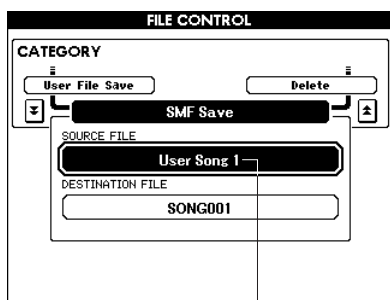
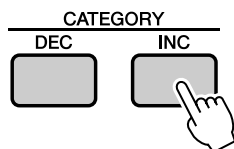

The Source User Song Name

4 Use the dial to select the source user song.

You can press the [INC/YES] and [DEC/NO] buttons simultaneously to select the first user song.

5 Press the [EXECUTE] button.

The DESTINATION FILE will be highlighted, and a default name will appear for the converted song file.

● To Overwrite an Existing File

If you want to overwrite a file that already exists on the USB storage device, use the dial or the [INC/YES] and [DEC/NO] buttons to select the file, then skip ahead to step 8.

6 Press the [EXECUTE] button. A cursor will appear below the first character in the file name.

7 Change the file name as necessary.

Refer to "Saving Data" on page 69 for filename entry.

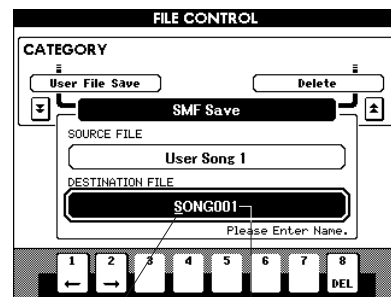

Cursor

The name of the file to be saved

8 Press the [EXECUTE] button.

A confirmation message will appear on the display. You can press the [DEC/NO] button at this point to cancel the operation.

9 Press the [EXECUTE] button again, or the [INC/YES] button, and the save operation will begin.

The user song will be stored to the USER FILES folder in the USB storage device.

⚠ CAUTION

- Once the save-in-progress message appears in the display, the operation cannot be canceled. Never turn off the power or remove the USB storage device during this operation.

10 A message will appear on the display when the operation is complete.

Press the [EXIT] button to return to the MAIN display.

NOTE

- If an existing filename is specified the display prompts you for confirmation. Press [EXECUTE] or [INC/YES] if it is OK to overwrite the file, or [DEC/NO] to cancel. You can press the [DEC/NO] button at this point to cancel the operation.
- The amount of time it will take to perform the save operation depends on the particular USB storage device you are using.

Loading User Files and Pattern Files

User and pattern files residing on a USB storage device can be loaded into the instrument.

CAUTION

- When a User file is loaded, user songs 001–005, the user patterns, and the performance memory will all be overwritten. If you only load a pattern file, only the user patterns will be overwritten. Save important data to a USB storage device before loading data that will overwrite it.
- Pattern files created on other Yamaha keyboards (“sty” file extension only) can be loaded into MM6/MM8 User Pattern No. 169. Pattern files cannot be created using the MM6/MM8.

1 With the USB storage device containing the file you want to load connected to the USB TO DEVICE connector, check that “CONNECT” is showing in the MAIN display.

2 Press the [MENU] button.

3 Use the CATEGORY [DEC] / [INC] buttons to locate the Load item.

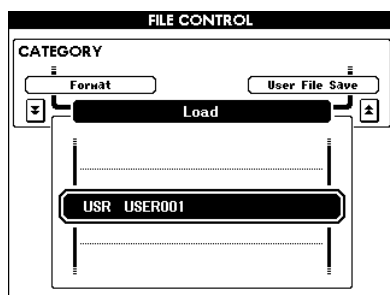
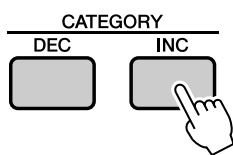

4 Use the dial to select the user file or pattern file you want to load.

All user files in the USB storage device will be displayed first, followed by the pattern files.

NOTE

- Pattern files must be located in the root directory. Pattern files located within folders will not be recognized.

5 Press the [EXECUTE] button.

A confirmation message will appear on the display. You can press the [DEC/NO] button at this point to cancel the operation.

6 Press the [EXECUTE] button again, or the [INC/YES] button, and the load operation will begin.

CAUTION

- Once the load-in-progress message appears in the display, the operation cannot be canceled. Never turn off the power or remove the USB storage device during this operation.

7 A message will appear on the display when the operation is complete.

Press the [EXIT] button to return to the MAIN display.

NOTE

- The SMF saved to a USB storage device can not be loaded as a user song.

Deleting Data from a USB Storage Device

This procedure deletes selected user files and SMF files from a USB storage device.

1 Make sure that the USB storage device containing the file(s) you want to delete has been properly connected to the instrument's USB TO DEVICE terminal, and that "CONNECT" is showing in the MAIN display.

2 Press the [MENU] button.

3 Use the CATEGORY [DEC] and [INC] buttons to locate the Delete item.

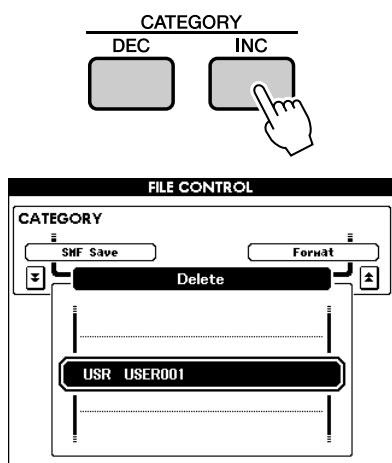

4 Select the file you want to delete.

You can press the [INC/YES] and [DEC/NO] buttons simultaneously to select the first song or user file on the USB storage device.

5 Press the [EXECUTE] button.

A confirmation message will appear on the display. You can press the [DEC/NO] button at this point to cancel the operation.

6 Press the [EXECUTE] button again, or the [INC/YES] button, and the delete operation will begin.

CAUTION

• Once the delete-in-progress message appears in the display, the operation cannot be canceled. Never turn off the power or remove the USB storage device during this operation.

7 A message will appear on the display when the operation is complete.

Press the [EXIT] button to return to the MAIN display.

NOTE

• If the USB storage device has been write-protected, an appropriate message will appear on the display and you will not be able to execute the operation.

Playing SMF Saved to a USB Storage Device

1 Make sure that the USB storage device containing the SMF you want to play has been properly connected to the instrument's USB TO DEVICE terminal, and that "CONNECT" is showing in the MAIN display.

2 Press the [USB] button.

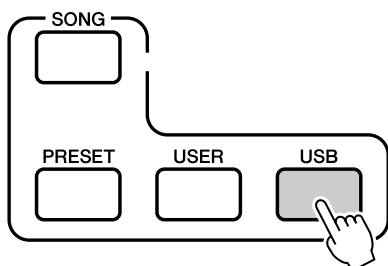

3 Use the dial to select the SMF you want to play.

4 Press the [START/STOP] button.

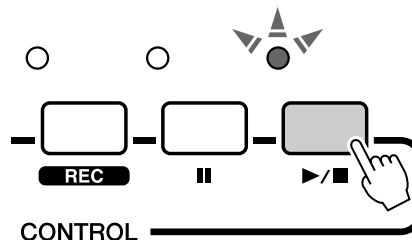

NOTE

• SMF playback will not be transmitted via MIDI.

The Connectors

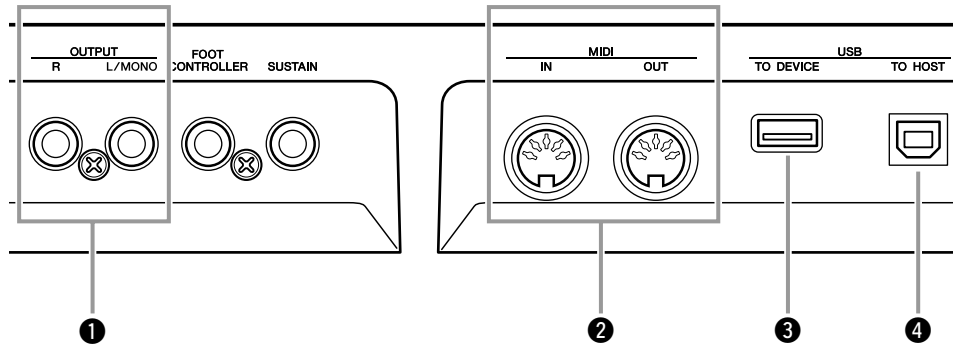

❶ OUTPUT L/MONO and R jacks

These jacks output stereo audio signals (1/4" mono phone plugs).
For monophonic output, use just the L/MONO jack.

❷ MIDI IN and OUT terminals

The MIDI IN connector receives MIDI messages from external MIDI devices. This can be used to control the MM6/MM8 or play it's tone-generator from an external MIDI device. The performance data and control data generated when it's controllers and knobs are operated is transmitted via the MIDI OUT connector.

❸ USB TO DEVICE terminal

This terminal allows connection to USB storage devices, (USB storage device, Floppy disk drive, Hard disk drive, etc.) and allows you to save data you've created to the connected device, as well as load data from the connected device.
Refer to "Connecting a USB Storage Device" on page 75 for more information.

❹ USB TO HOST terminal

This terminal allows direct connection to a personal computer, and allows you to transfer MIDI data between the devices.
Refer to "Connecting to a Personal Computer" on page 77 for more information.

Connecting to External Audio Equipment

Since the MM6/MM8 has no built-in speakers, it must be connected to an external amplifier and speakers, headphones, or other sound output device.

■ Connecting to Powered Speakers or Monitor Speakers.....

For optimum, accurate reproduction of the instrument’s rich sounds with effects and full stereo imaging, use a pair of powered speakers. Connect the powered speakers to the OUTPUT L/MONO and R jacks on the rear panel.

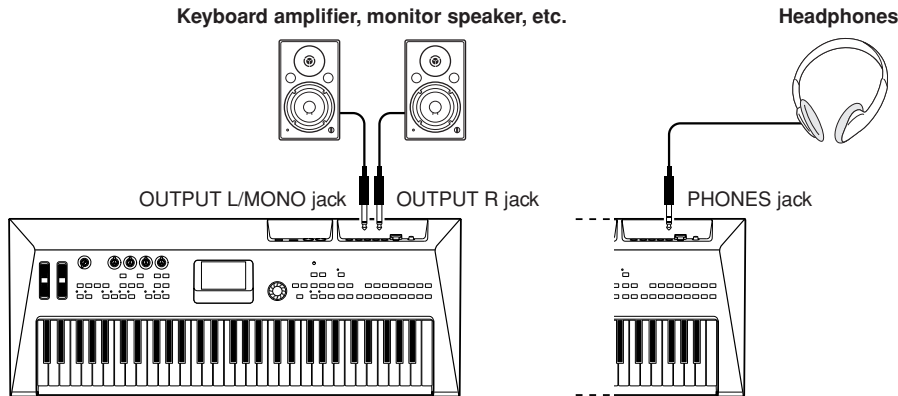

NOTE

• When using just one powered speaker, connect it to the OUTPUT L/MONO jack on the rear panel.

Connecting to External MIDI Devices

NOTE

• MIDI data can be received and transmitted via the MIDI connectors as well as the USB TO HOST terminal. However, they cannot be used at the same time.

■ Controlling an External Tone Module

This type of connection lets you play an external MIDI tone generator (tone generator module, etc.) from the MM6/MM8 keyboard, or by playing back the MM6/MM8 songs or patterns.

Use this connection when you want the external instrument to sound as well as the MM6/MM8.

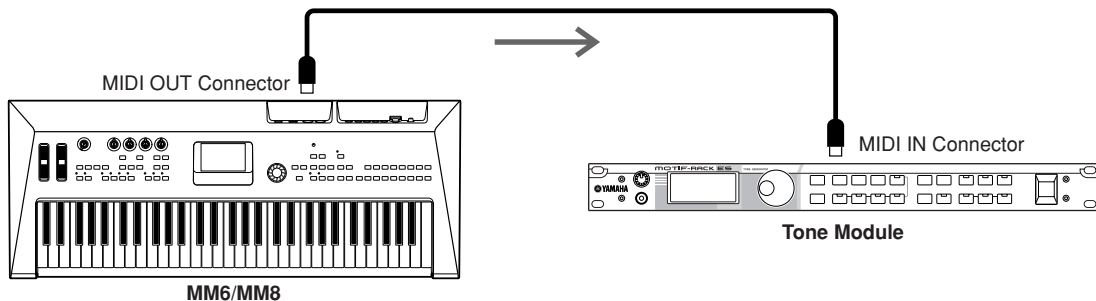

In order to play the external tone module in this type of setup, the MIDI receive channel of the tone module must be set to the same channel as the MM6/MM8 MIDI transmit channel.

The MM6/MM8 transmit channels are fixed, as shown below.

Main Voice	Channel 1
Dual Voice	Channel 2
Split Voice	Channel 3

Connecting a USB Storage Device

You can connect a USB storage device to the USB TO DEVICE terminal on the rear panel of this instrument.

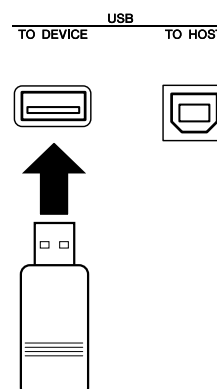

■ Precautions when using the [USB TO DEVICE] terminal

This instrument features a built-in [USB TO DEVICE] terminal. When connecting a USB device to the terminal, be sure to handle the USB device with care. Follow the important precautions below.

NOTE

- For more information about the handling of USB devices, refer to the owner's manual of the USB device.

● Compatible USB devices

- USB storage devices (flash memory, floppy disk drive, hard disk drive, etc.)

The instrument does not necessarily support all commercially available USB devices. Yamaha cannot guarantee operation of USB devices that you purchase. Before purchasing a USB device for use with this instrument, please visit the following web page:

<http://www.yamahasyth.com/>

NOTE

- Other USB devices such as a computer keyboard or mouse cannot be used.

● Connecting USB device

- When connecting a USB device to the [USB TO DEVICE] terminal, make sure that the connector on the device is appropriate and that it is connected in the proper direction.

CAUTION

- Though the instrument supports the USB 1.1 standard, you can connect and use a USB 2.0 storage device with the instrument. However, note that the transfer speed is that of USB 1.1.

● Using USB Storage Devices

By connecting the instrument to a USB storage device, you can save data you've created to the connected device, as well as read data from the connected device.

NOTE

- Although CD-R/RW drives can be used to read data to the instrument, they cannot be used for saving data.

Formatting USB storage media

When a USB storage device is connected or media is inserted, a message may appear prompting you to format the device/media. If so, execute the Format operation (page 68).

CAUTION

- The format operation overwrites any previously existing data. Make sure that the media you are formatting does not contain important data.

To protect your data (write-protect)

To prevent important data from being inadvertently erased, apply the write-protect provided with each storage device or media. If you are saving data to the USB storage device, make sure to disable write-protect.

Connecting/removing USB storage device

Before removing the media from the device, make sure that the instrument is not accessing data (such as in the Save, Copy and Delete operations).

CAUTION

- Avoid frequently turning the power on/off to the USB storage device, or connecting/disconnecting the device too often. Doing so may result in the operation of the instrument "freezing" or hanging up. While the instrument is accessing data (such as during Save, Copy, Delete, Load and Format operations) or is mounting the USB storage device (shortly after the connection), do NOT unplug the USB connector, do NOT remove the media from the device, and do NOT turn the power off to either device. Doing so may corrupt the data on either or both devices.

Backing up instrument data to a computer.

Once you've saved data to a USB storage device, you can copy the data to the hard disk of your computer, then archive and organize the files as desired.

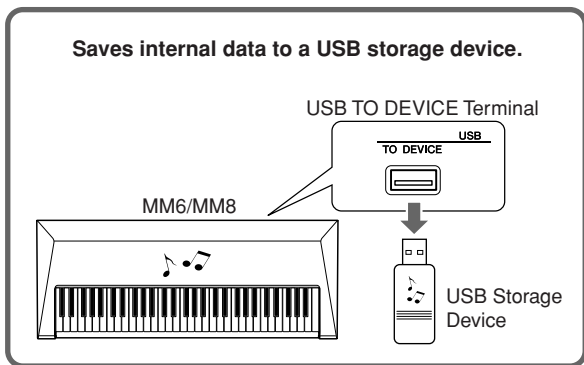

Disconnect the USB storage device from the computer and connect it to the instrument.

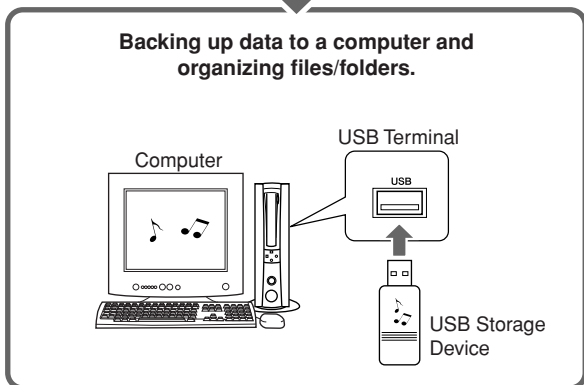

Copying files from a computer hard disk to a USB storage device, and then playing back the songs on the instrument.

Files on a computer's hard disk can be transferred to the instrument by first copying them to a USB storage device, and then connecting the media to the instrument.

User files, pattern files, and MIDI songs can be copied to a USB storage device from the hard disk of the computer. Once you've copied the data, connect the device to the USB TO DEVICE terminal of the instrument and play back the MIDI songs, or load the user file or pattern file into the instrument.

NOTE

• In the case of Macintosh OS X a file with a different name will sometimes be created. Always select the file with the original name when loading into the instrument.

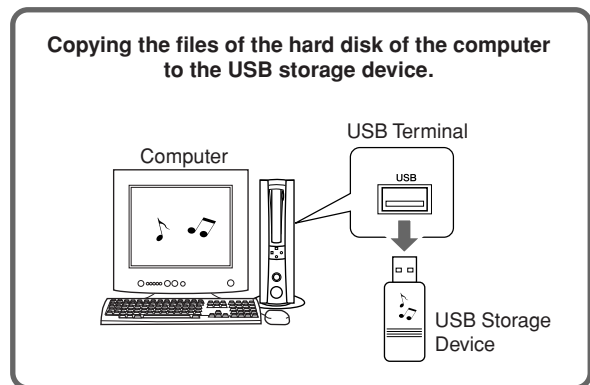

Disconnect the USB storage device from the computer and connect it to the instrument.

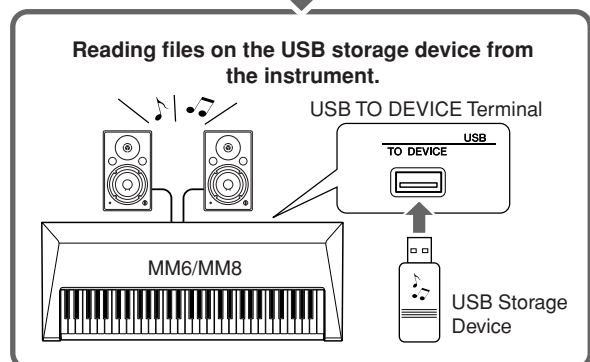

Connecting to a Personal Computer

The following functions become available when this instrument is connected to a computer.

■ Installing the USB-MIDI Driver ..

In order to be able to communicate with and use instruments connected to your computer, the appropriate driver software must be properly installed on your computer.

The USB-MIDI driver allows sequence software and similar applications on your computer to transmit and receive MIDI data to and from MIDI devices via a USB cable.

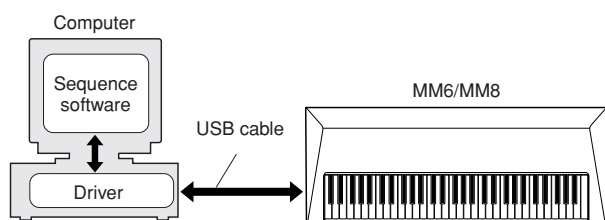

1 Download the proper driver from our website:

http://www.global.yamaha.com/download/usb_midi/

Versions are available for:

Windows Vista, XP Professional/Home Edition

Macintosh: OS X 10.2.8–10.5.1

2 Install the USB MIDI driver on the computer.

Refer to the installation instructions included with the download package.

3 Connect the computer to the instrument with a USB cable.

For details, see the page 78.

■ USB Precautions.....

Please observe the following precautions when connecting the instrument to a computer via a USB cable. Failing to do so can cause the instrument and/or the computer to hang up (freeze), possibly causing corruption or loss of data. If the instrument or computer does hang up, turn the power to both devices off and then on again, and restart the computer.

⚠ CAUTION

- Use an AB type USB cable of less than about 3 meters.
- Before connecting the computer to the USB TO HOST connector, exit from any computer power-saving mode (such as suspended, sleep, standby).
- Before turning on the power to the instrument, connect the computer to the USB TO HOST connector.
- Check the following points before turning the instrument's power on or off, and before plugging or unplugging the USB cable.
 - Quit all applications.
 - Make sure that no data transfer is in progress. (Data is transmitted whenever you play the keyboard or play back a song.)
- Allow at least 6 seconds between turning the instrument's power on and off, and between plugging and unplugging the USB cable.
- Directly connect the instrument to the computer using a single USB cable. Do not use a hub.

Transferring Performance Data to and from a Computer

By connecting the instrument to a computer, the instrument's performance data can be used on the computer, and performance data from the computer can be played on the instrument.

● Transferring Performance Data Between the Instrument and a Computer

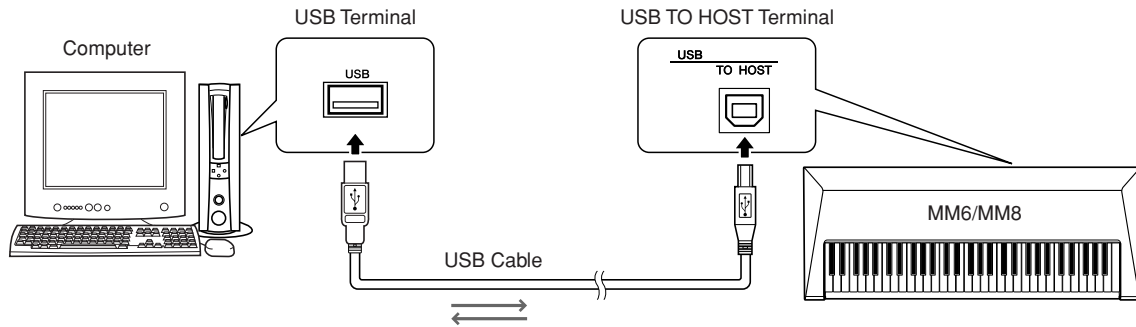

■ MIDI settings

These settings pertain to performance data transmission and reception.

Item	Range/Settings	Description
Local	ON/OFF	Local control determines whether or not notes played on the instrument are sounded by its internal tone generator system: the internal tone generator is active when local control is on, and inactive when local control is off.
External Clock	ON/OFF	This setting determines whether the instrument is synchronized to its own internal clock (OFF), or to a clock signal from an external device (ON).
Keyboard Out	ON/OFF	This setting determines whether keyboard performance is transmitted via the MIDI output (ON) or not (OFF). When Keyboard Out is set to ON, the main voice will be transmitted via MIDI channel 1, the dual voice will be transmitted via MIDI channel 2, and the split voice will be transmitted via MIDI channel 3.
Pattern Out	ON/OFF	This setting determines whether keyboard performance data is transmitted via the MIDI output (ON) or not (OFF).
Song Out	ON/OFF	This setting determines whether keyboard song data is transmitted via the MIDI output (ON) or not (OFF). SMF playback will not be transmitted via MIDI.

CAUTION

• If you can't get any sound out of the instrument, the Local setting may be the most likely cause.

CAUTION

• If External Clock is ON and no clock signal is being received from an external device, the song, pattern, and metronome functions will not start.

1 Press the [UTILITY] button to go to the UTILITY display.

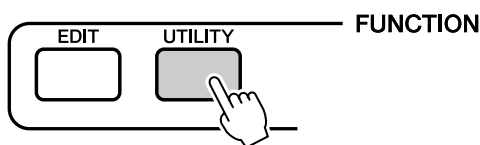

2 Use the CATEGORY [DEC] and [INC] buttons to select the item you want to set.

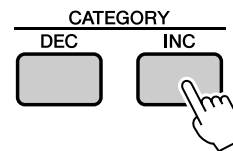

3 Use the dial to select ON or OFF.

■ PC Mode

The PC Mode item can conveniently make multiple settings for you in one operation. Select ON or OFF.

	ON	OFF
Local	OFF	ON
External Clock	ON	OFF
Song Out	ON	ON
Style Out	ON	ON
Keyboard Out	ON	ON

1 Press the [UTILITY] button to go to the UTILITY display.

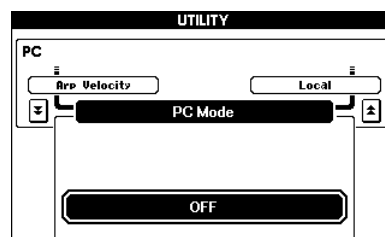
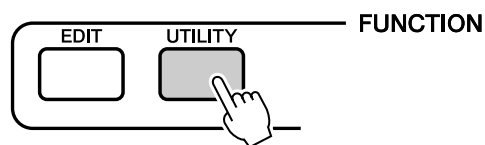

2 Use the CATEGORY [DEC] and [INC] buttons to select the PC Mode item.

3 Use the dial to select ON or OFF.

Initial Setup

“Initial Setup Data” is all multi-timbral tone generator settings for 16 parts, including main, dual, split, song, and pattern parts. The Initial Setup Data can be transmitted via MIDI. When using an external sequencer or keyboard to play the instrument, the corresponding settings can be made automatically by transmitting the Initial Setup Data to the instrument before beginning playback.

1 Press the [UTILITY] button to go to the UTILITY display.

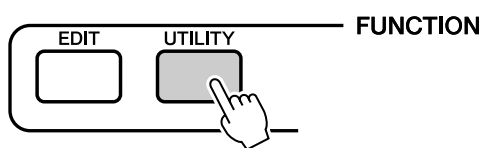

2 Use the CATEGORY [DEC] / [INC] buttons to select the Initial Setup item.

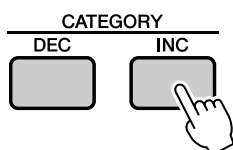

3 Press [INC/YES] to send.

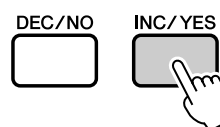

NOTE

• Initial Setup Data consists of 16 MIDI channels. Record the data for each channel on a separate track when recording to an external sequencer.

About the Supplied Disk

SPECIAL NOTICES

- This owner's manual is the exclusive copyrights of Yamaha Corporation.
- The supplied software is the exclusive copyrights of Steinberg Media Technologies GmbH.
- Use of the supplied software and this manual is governed by the license agreement which the purchaser fully agrees to upon breaking the seal of the software packaging. (Please read carefully the Software Licensing Agreement at the page 81 of this manual before installing the application.)
- Copying of the supplied software or reproduction of this manual in whole or in part by any means is expressly forbidden without the written consent of the manufacturer.
- Yamaha makes no representations or warranties with regard to the use of the software and documentation and cannot be held responsible for the results of the use of this manual and the software.
- The supplied software disk is not an audio CD. Do not attempt to play it on a standard audio/video CD or DVD player.
- Please check the latest information about the supplied software and system requirements at the following URL:
<http://www.yamahasyth.com/>
- Yamaha Corporation does not provide support for the supplied software.

About the Supplied DAW Software

The supplied disk includes DAW software for Windows and Macintosh computers.

NOTE

- Make sure to install DAW software under the "Administrator" account.
- In order to have continuous use of the DAW software in the accessory disk, including support and other benefits, you will need to register the software and activate your software license by starting it while the computer is connected to the Internet. Click the "Register Now" button shown when the software is started, then fill in all required fields for registration. If you do not register the software, you will be unable to use it after a limited period of time expires.
- Macintosh users can begin the installation process by double-clicking the icon with the ".mpkg" file name extension.

Refer to the URL below for the latest information on system requirements.

<http://www.yamahasyth.com/>

Support

Support for the DAW software in the accessory disk is provided by Steinberg on its website at the following address.

<http://www.steinberg.net>

You can visit the Steinberg site also via the Help menu of the included DAW software. (The Help menu also includes the PDF manual and other information on the software.)

ATTENTION SOFTWARE LICENSE AGREEMENT

PLEASE READ THIS SOFTWARE LICENSE AGREEMENT (“AGREEMENT”) CAREFULLY BEFORE USING THIS SOFTWARE. YOU ARE ONLY PERMITTED TO USE THIS SOFTWARE PURSUANT TO THE TERMS AND CONDITIONS OF THIS AGREEMENT. THIS AGREEMENT IS BETWEEN YOU (AS AN INDIVIDUAL OR LEGAL ENTITY) AND YAMAHA CORPORATION (“YAMAHA”).

BY BREAKING THE SEAL OF THIS PACKAGE YOU ARE AGREEING TO BE BOUND BY THE TERMS OF THIS LICENSE. IF YOU DO NOT AGREE WITH THE TERMS, DO NOT INSTALL, COPY, OR OTHERWISE USE THIS SOFTWARE.

THIS AGREEMENT PROVIDES YOUR USE-CONDITIONS ABOUT THE “DAW” SOFTWARE OF STEINBERG MEDIA TECHNOLOGIES GMBH (“STEINBERG”) WHICH IS BUNDLED WITH THIS PRODUCT. SINCE THE END-USER SOFTWARE LICENSE AGREEMENT (EUSLA) SHOWN ON YOUR PC-DISPLAY IN YOUR INSTALLING THE “DAW” SOFTWARE IS REPLACED BY THIS AGREEMENT, YOU SHOULD DISREGARD THE EUSLA. THAT IS, IN THE INSTALLING PROCESS, YOU SHOULD SELECT “AGREE” WITH THE EUSLA, WITHOUT YOUR JUDGMENT THERETO, SO AS TO PROCEED TO THE NEXT PAGE.

1. GRANT OF LICENSE AND COPYRIGHT

Yamaha hereby grants you the right to use one copy of the software program(s) and data (“SOFTWARE”) accompanying this Agreement. The term SOFTWARE shall encompass any updates to the accompanying software and data. The SOFTWARE is owned by STEINBERG, and is protected by relevant copyright laws and all applicable treaty provisions. Yamaha has acquired the sublicense right to license you to use the SOFTWARE. While you are entitled to claim ownership of the data created with the use of SOFTWARE, the SOFTWARE will continue to be protected under relevant copyrights.

- **You may** use the SOFTWARE on a **single computer**.
- **You may** make one copy of the SOFTWARE in machine-readable form for backup purposes only, if the SOFTWARE is on media where such backup copy is permitted. On the backup copy, you must reproduce Yamaha’s copyright notice and any other proprietary legends that were on the original copy of the SOFTWARE.
- **You may** permanently transfer to a third party all your rights in the SOFTWARE only when you transfer this product together, provided that you do not retain any copies and the recipient reads and agrees to the terms of this Agreement.

2. RESTRICTIONS

- **You may not** engage in reverse engineering, disassembly, decompilation or otherwise deriving a source code form of the SOFTWARE by any method whatsoever.
- **You may not** reproduce, modify, change, rent, lease, or distribute the SOFTWARE in whole or in part, or create derivative works of the SOFTWARE.
- **You may not** electronically transmit the SOFTWARE from one computer to another or share the SOFTWARE in a network with other computers.
- **You may not** use the SOFTWARE to distribute illegal data or data that violates public policy.
- **You may not** initiate services based on the use of the SOFTWARE without permission by Yamaha Corporation

Copyrighted data, including but not limited to MIDI data for songs, obtained by means of the SOFTWARE, are subject to the following restrictions which you must observe.

- Data received by means of the SOFTWARE may not be used for any commercial purposes without permission of the copyright owner.
- Data received by means of the SOFTWARE may not be duplicated, transferred, or distributed, or played back or performed for listeners in public without permission of the copyright owner.
- The encryption of data received by means of the SOFTWARE may not be removed nor may the electronic watermark be modified without permission of the copyright owner.

3. TERMINATION

This Agreement becomes effective on the day that you receive the SOFTWARE and remains effective until terminated. If any copyright law or provisions of this Agreement is violated, the Agreement shall terminate automatically and immediately without notice from Yamaha. Upon such termination, you must immediately destroy the licensed SOFTWARE, any accompanying written documents and all copies thereof.

4. LIMITED WARRANTY ON MEDIA

As to SOFTWARE sold on tangible media, Yamaha warrants that the tangible media on which the SOFTWARE is recorded will be free from defects in materials and workmanship under normal use for a period of fourteen (14) days from the date of receipt, as evidenced by a copy of the receipt. Yamaha’s entire

liability and your exclusive remedy will be replacement of the defective media if it is returned to Yamaha or an authorized Yamaha dealer within fourteen days with a copy of the receipt. Yamaha is not responsible for replacing media damaged by accident, abuse or misapplication. TO THE FULLEST EXTENT PERMITTED BY LAW, YAMAHA EXPRESSLY DISCLAIMS ANY IMPLIED WARRANTIES ON THE TANGIBLE MEDIA, INCLUDING THE IMPLIED WARRANTIES OF MERCHANTABILITY AND FITNESS FOR A PARTICULAR PURPOSE.

5. DISCLAIMER OF WARRANTY ON SOFTWARE

You expressly acknowledge and agree that use of the SOFTWARE is at your sole risk. The SOFTWARE and related documentation are provided “AS IS” and without warranty of any kind. NOTWITHSTANDING ANY OTHER PROVISION OF THIS AGREEMENT, YAMAHA EXPRESSLY DISCLAIMS ALL WARRANTIES AS TO THE SOFTWARE, EXPRESS, AND IMPLIED, INCLUDING BUT NOT LIMITED TO THE IMPLIED WARRANTIES OF MERCHANTABILITY, FITNESS FOR A PARTICULAR PURPOSE AND NON-INFRINGEMENT OF THIRD PARTY RIGHTS. SPECIFICALLY, BUT WITHOUT LIMITING THE FOREGOING, YAMAHA DOES NOT WARRANT THAT THE SOFTWARE WILL MEET YOUR REQUIREMENTS, THAT THE OPERATION OF THE SOFTWARE WILL BE UNINTERRUPTED OR ERROR-FREE, OR THAT DEFECTS IN THE SOFTWARE WILL BE CORRECTED.

6. LIMITATION OF LIABILITY

YAMAHA’S ENTIRE OBLIGATION HEREUNDER SHALL BE TO PERMIT USE OF THE SOFTWARE UNDER THE TERMS HEREOF. IN NO EVENT SHALL YAMAHA BE LIABLE TO YOU OR ANY OTHER PERSON FOR ANY DAMAGES, INCLUDING, WITHOUT LIMITATION, ANY DIRECT, INDIRECT, INCIDENTAL OR CONSEQUENTIAL DAMAGES, EXPENSES, LOST PROFITS, LOST DATA OR OTHER DAMAGES ARISING OUT OF THE USE, MISUSE OR INABILITY TO USE THE SOFTWARE, EVEN IF YAMAHA OR AN AUTHORIZED DEALER HAS BEEN ADVISED OF THE POSSIBILITY OF SUCH DAMAGES. In no event shall Yamaha’s total liability to you for all damages, losses and causes of action (whether in contract, tort or otherwise) exceed the amount paid for the SOFTWARE.

7. GENERAL

This Agreement shall be interpreted according to and governed by Japanese law without reference to principles of conflict of laws. Any dispute or procedure shall be heard before the Tokyo District Court in Japan. If for any reason a court of competent jurisdiction finds any portion of this Agreement to be unenforceable, the remainder of this Agreement shall continue in full force and effect.

8. COMPLETE AGREEMENT

This Agreement constitutes the entire agreement between the parties with respect to use of the SOFTWARE and any accompanying written materials and supersedes all prior or contemporaneous understandings or agreements, written or oral, regarding the subject matter of this Agreement. No amendment or revision of this Agreement will be binding unless in writing and signed by a fully authorized representative of Yamaha.

Troubleshooting

Problem	Possible Cause and Solution
A popping sound is heard when the instrument is turned on or off.	This is normal, and is caused by the brief current surge produced when the device is turned on or off. Be sure to turn the volume down when turning the device on or off.
Noise is produced when using a mobile phone.	To prevent this, turn off the mobile phone or use it further away from the instrument. Using a mobile phone in close proximity to the instrument may produce interference.
There is no sound even when the keyboard is played or when a song or pattern is being played back.	Check the Local Control on/off setting. (See page 78).
	Is the FILE CONTROL display showing? The instrument's keyboard, etc., will not produce any sound while the FILE CONTROL display is showing. Press the [EXIT] button to return to the MAIN display.
The pattern or song does not play back when the [START/STOP] button is pressed.	Is External Clock set to ON? Make sure External Clock is set to OFF; refer to "External Clock" on page 78.
The pattern does not sound properly.	Make sure that the pattern volume is set to an appropriate level. (See page 53).
	Is the split point set at an appropriate key for the chords you are playing? Set the split point an appropriate key (page 52). Is the [FINGER] button indicator lit? If not, press the [FINGER] button so that it does light.
Only the pattern rhythm plays even if the [FINGER] button indicator is lit when pattern number 113 through 168 is selected.	This is normal. Pattern numbers 113 through 168 only include a rhythm part, so not other pattern parts will play. Select a pattern number other than 113–168 to hear parts other than the rhythm part.
Not all of the voices seem to sound, or the sound seems to be cut off. Or, the pattern or song sound is interrupted when playing on the keyboard.	The instrument is polyphonic up to a maximum of 32 notes. If the Dual voice or Split voice is being used and a style or song is playing back at the same time, some notes/sounds may be omitted (or "stolen") from the accompaniment or song.
The footswitch (for sustain) seems to produce the opposite effect. For example, pressing the footswitch cuts off the sound and releasing it sustains the sounds.	The polarity of the footswitch is reserved. Make sure that the footswitch plug is properly connected to the SUSTAIN jack before turning on the power.
The sound of the voice changes from note to note.	This is normal. The AWM tone generation method uses multiple recordings (samples) of an instrument across the range of the keyboard; thus, the actual sound of the voice may be slightly different from note to note.
The [FINGER] button indicator does not light even when the button is pressed.	Is the pattern selection screen showing? Be sure to press the [PATTERN] button before using any of the pattern-related functions.
When a voice is changed during recording the DSP effect is not applied as expected.	During recording the DSP type set before recording was begun is maintained. For this reason the expected DSP effect may not be applied if you change voices. This is not a malfunction.
The volume changes when DSP is turned ON or OFF.	Some voices change in volume when the DSP effects are turned ON or OFF. This is not a malfunction.
The DSP effect doesn't sound as expected.	Only one DSP effect can be active at a time for the entire instrument. It is for this reason that, for example, the DSP effect may not sound as expected when playing the keyboard while playing back a song or pattern loaded from an external device. The DSP settings are saved with the song and pattern data. This is not a malfunction.
The "OverCurrent" is shown in the upper-right area of the MAIN display and the USB device does not respond.	Communication with the USB device has been shut down because of the overcurrent to the USB device. Disconnect the device from the [USB TO DEVICE] terminal, then turn on the power of the instrument.

Messages

LCD Message	Comment
Access error!	Indicates the failure in reading or writing from/to the media or the flash memory.
All Memory Clearing...	Displayed while erasing all data in the flash memory. Never turn the power off during data transmission.
Are you sure?	Confirms whether Song Clear or Track Clear is executed or not.
Backup Clearing...	Displayed while clearing the back-up data in the flash memory.
Cancel	Displayed when the transmission of Initial Send is cancelled.
Clearing...	Displayed while executing Song Clear or Track Clear for a user song.
Completed	Indicates the completion of the specified job, such as saving data or transmission.
Data Error!	Displayed when the user song contains illegal data.
End	Displayed when transmission of Initial Setup data has been completed.
Error!	Displayed when a write operation has failed.
File information area is not large enough.	Indicates that data cannot be saved to the media because the total number of files is too large.
File is not found.	Indicates that there is no file.
File too large. Loading is impossible.	Indicates that data cannot be loaded because the file is too large.
Format OK ? [EXECUTE]	Confirms whether the media format operation is executed or not.
Formatting...	Displayed while formatting.
Load OK ?	Confirms whether loading is executed or not.
Loading...	Displayed while loading data.
Media is not inserted.	This message will appear if you attempt to access a memory device when no memory device is connected to the USB TO DEVICE terminal.
Media capacity is full.	Displayed when data cannot be saved because the memory media is full.
Memory Full	Displayed when the internal memory becomes full during song recording.
MIDI receive buffer overflow.	Displayed when the MIDI receive buffers overflows.
Now Writing... (Don't turn off the power now, otherwise the data may be damaged.)	Displayed while writing data to the memory. Never turn the power off while writing. Doing so may result in data loss.
Overwrite ?	Confirms whether overwriting is executed or not
Save OK ?	Confirms whether saving is executed or not
Saved data is not found.	Displayed when the data to be saved doesn't exist.
Saving...	Displayed while saving data to the memory. Never turn the power off while saving. Doing so may result in data loss.
Send OK?	Confirms whether the data transmission is executed or not
Sending...	Displayed while transmitting data.
Since the media is in use now, this function is not available.	Indicates that the file control function is currently unavailable since the media is being accessed.
Sure ? [YES/NO]	Reconfirms whether each operation is executed or not
The limit of the media has been reached.	Indicates that data cannot be saved because the folder/directory structure has become too complicated.
The media is not formatted.	Indicates that the inserted media has not been formatted.
The media is write-protected.	Indicates that the inserted media cannot be written to because it is write-protected. Set the write-protect switch to the "overwrite" position before use.
There are too many files.	Indicates that data cannot be saved because the total number of files exceeds the maximum capacity.
This function is not available now.	Indicates that the designated function is not available because the instrument is executing another job.

NOTE

• Not all messages are listed in the table.

Voice List

■ Maximum Polyphony.....

The instrument has 32-note maximum polyphony. This means that it can play a maximum of up to 32 notes at once, regardless of what functions are used. Auto accompaniment uses a number of the available notes, so when auto accompaniment is used the total number of available notes for playing on the keyboard is correspondingly reduced. The same applies to the Split Voice and Song functions. If the maximum polyphony is exceeded, earlier played notes will be cut off and the most recent notes have priority (last note priority).

NOTE

- The Voice List includes MIDI program change numbers for each voice. Use these program change numbers when playing the instrument via MIDI from an external device.
- Program Numbers 001 to 128 directly relate to MIDI Program Change Numbers 000 to 127. That is, Program Numbers and Program Change Numbers differ by a value of 1. Remember to take this into consideration.
- Some voices may sound continuously or have a long decay after the notes have been released while the sustain pedal (footswitch) is held.

● Panel Voice List

Voice No.	Order in category	Bank Select		MIDI Program Change (1-128)	Voice Name
		MSB (0-127)	LSB (0-127)		
PIANO					
1	1	0	113	1	Power Grand
2	2	0	113	2	Aggressive
3	3	0	112	2	Bright Piano
4	4	0	115	1	Classic Piano
5	5	0	114	1	Warm Grand
6	6	0	116	1	Amb Piano
7	7	0	112	7	Harpsichord
8	8	0	112	4	Honky-tonk Piano
9	9	0	112	3	MIDI Grand Piano
10	10	0	113	3	CP 80
11	11	0	0	1	GM Grand Piano
12	12	0	0	2	GM Bright Piano
13	13	0	0	3	GM Electric Grand
14	14	0	0	4	GM Honky-tonk
15	15	0	0	7	GM Harpsichord
KEYBOARD/ORGAN					
16	1	0	117	5	Sweetness
17	2	0	112	5	Chorus EP
18	3	0	115	5	80th Boost
19	4	0	115	6	Early 70's
20	5	0	116	5	Vintage'74
21	6	0	117	6	Vintage Case
22	7	0	118	5	Cool! Suitcase EP
23	8	0	113	5	Tremolo EP
24	9	0	119	5	Wurli Tremolo
25	10	0	119	6	Wurli Amped
26	11	0	114	5	Cool! Galaxy EP
27	12	0	112	6	DX Modern EP
28	13	0	113	6	Hyper Tines
29	14	0	114	6	Venus EP
30	15	0	116	6	New Tines
31	16	0	118	6	Ana Piano
32	17	0	112	8	Clavi
33	18	0	113	8	Super Clavi
34	19	0	114	8	Nu Phasing
35	20	0	115	8	Touch Clavi
36	21	0	116	8	Reso Clavi
37	22	0	117	8	Wah Clavi
38	23	0	112	17	Petit
39	24	0	114	17	Clean
40	25	0	115	17	Tiny

Voice No.	Order in category	Bank Select		MIDI Program Change (1-128)	Voice Name
		MSB (0-127)	LSB (0-127)		
41	26	0	113	18	Vintage C
42	27	0	114	18	C Vibrato
43	28	0	115	18	Mellow
44	29	0	116	17	Bright Organ
45	30	0	118	19	Cool! Organ
46	31	0	117	19	Cool! Rotor Organ
47	32	0	113	17	Jazz Organ
48	33	0	112	18	Click Organ
49	34	0	121	20	16'+2' Organ
50	35	0	120	20	16'+4' Organ
51	36	0	40	17	16'+2'2/3 Organ
52	37	0	113	19	Progressy
53	38	0	114	19	Rock Percussive
54	39	0	115	19	Rock Vibrato
55	40	0	112	19	Rock Organ
56	41	0	114	20	1967 Keys
57	42	0	116	20	Sea Horse
58	43	0	115	20	Compact
59	44	0	117	20	Saw Combo
60	45	0	127	19	Theater Organ
61	46	0	113	20	Chapel Organ
62	47	0	112	20	Church Organ
63	48	0	112	21	Reed Organ
64	49	0	112	12	Vibraphone
65	50	0	112	13	Marimba
66	51	0	112	14	Xylophone
67	52	0	112	9	Celesta
68	53	0	40	99	Glocken Chimes
69	54	0	112	11	Music Box
70	55	0	64	11	Orgel
71	56	0	113	113	Random Bell
72	57	0	112	113	Twinkle
73	58	0	112	15	Tubular Bells
74	59	0	112	115	Steel Drums
75	60	0	112	48	Timpani
76	61	0	112	22	Musette Accordion
77	62	0	113	22	Trad Accordion
78	63	0	113	24	Bandoneon
79	64	0	113	23	Modern Harp
80	65	0	112	23	Harmonica
81	66	0	0	5	GM E.Piano 1
82	67	0	0	6	GM E.Piano 2

Voice No.	Order in category	Bank Select		MIDI Program Change (1–128)	Voice Name
		MSB (0–127)	LSB (0–127)		
83	68	0	0	8	GM Clavi
84	69	0	0	17	GM Drawbar Organ
85	70	0	0	18	GM Percussive Org
86	71	0	0	19	GM Rock Organ
87	72	0	0	20	GM Church Organ
88	73	0	0	21	GM Reed Organ
89	74	0	0	23	GM Harmonica
90	75	0	0	22	GM Accordion
91	76	0	0	24	GM Tango Accord.
92	77	0	0	9	GM Celesta
93	78	0	0	10	GM Glockenspiel
94	79	0	0	113	GM Tinkle Bell
95	80	0	0	11	GM Music Box
96	81	0	0	12	GM Vibraphone
97	82	0	0	13	GM Marimba
98	83	0	0	14	GM Xylophone
99	84	0	0	15	GM Tubular Bells
100	85	0	0	16	GM Dulcimer
101	86	0	0	114	GM Agogo
102	87	0	0	115	GM Steel Drums
103	88	0	0	48	GM Timpani
GUITAR/BASS					
104	1	0	117	26	Live! Steel Guitar
105	2	0	115	26	Strummer
106	3	0	118	26	Dyno Steel Guitar
107	4	0	113	26	12Str Guitar
108	5	0	119	26	Mega Steel Guitar
109	6	0	119	26	Spanish Steel
110	7	0	119	26	Unplug Reversible
111	8	0	112	28	Clean Guitar
112	9	0	113	29	Funk Guitar
113	10	0	114	28	Deep Chorus
114	11	0	117	29	Single Dream
115	12	0	117	29	Hard Armer
116	13	0	119	28	Electric 12Str Gt
117	14	0	122	28	Wah Guitar
118	15	0	115	28	Mega Clean Guitar
119	16	0	115	28	Auto Funk
120	17	0	115	28	9th Shaky
121	18	0	117	28	60's Clean Guitar
122	19	0	112	30	Overdriven Guitar
123	20	0	117	30	Cool! Blues Guitar
124	21	0	112	31	Distortion Guitar
125	22	0	113	28	Combo Amped
126	23	0	118	28	60's Distortion
127	24	0	112	30	Heavy Distortion
128	25	0	113	30	Mega Overdrive Gt
129	26	0	113	30	Heavy Pop
130	27	0	114	30	Over The Top
131	28	0	114	30	Bottom Boost
132	29	0	112	25	Classical Guitar
133	30	0	112	26	Folk Guitar
134	31	0	112	27	Jazz Guitar
135	32	0	113	27	Octave Guitar
136	33	0	112	29	Muted Guitar
137	34	0	112	34	Finger Bass
138	35	0	112	33	Acoustic Bass

Voice No.	Order in category	Bank Select		MIDI Program Change (1–128)	Voice Name
		MSB (0–127)	LSB (0–127)		
139	36	0	112	35	Pick Bass
140	37	0	112	36	Fretless Bass
141	38	0	112	37	Slap Bass
142	39	0	112	40	Simple Bass
143	40	0	114	39	Fat Pulse
144	41	0	114	40	Dark Bass
145	42	0	115	39	One Voice
146	43	0	115	40	Mini Sub
147	44	0	116	39	Fat Sine Resonance
148	45	0	116	40	Ballad Bass
149	46	0	113	87	Long Spit
150	47	0	113	88	Lately
151	48	0	117	39	Boogie A
152	49	0	114	81	Wazoo
153	50	0	114	82	Velo Master
154	51	0	117	40	Trance Bass
155	52	0	118	39	Deep Point
156	53	0	118	40	Short FM
157	54	0	119	39	Competitor
158	55	0	119	40	1o1 Sub L
159	56	0	120	39	1o1 Sub S
160	57	0	120	40	1o1 Bass
161	58	0	121	39	Big Bass
162	59	0	121	40	Bobby Bass
163	60	0	122	39	Fundamental
164	61	0	122	40	Old House
165	62	0	123	39	Seq Bass
166	63	0	123	40	Booty Bass
167	64	0	124	39	Hard Syn Bass
168	65	0	124	40	Funky Bass
169	66	0	125	39	Tekno Bass
170	67	0	125	40	Knock Bass
171	68	0	126	39	Perc Punch
172	69	0	126	40	Echo Bass
173	70	0	127	39	P.Mod Bass
174	71	0	112	39	Synth Bass
175	72	0	113	39	Hi-Q Bass
176	73	0	113	40	Dance Bass
177	74	0	116	39	Primitive Arp Bass
178	75	0	117	39	Clip Beat
179	76	0	113	88	Lately Arp
180	77	0	0	25	GM Nylon Guitar
181	78	0	0	26	GM Steel Guitar
182	79	0	0	27	GM Jazz Guitar
183	80	0	0	28	GM Clean Guitar
184	81	0	0	29	GM Muted Guitar
185	82	0	0	30	GM Overdriven Gt
186	83	0	0	31	GM Distortion Gt
187	84	0	0	32	GM Gt Harmonics
188	85	0	0	33	GM Acoustic Bass
189	86	0	0	34	GM Finger Bass
190	87	0	0	35	GM Pick Bass
191	88	0	0	36	GM Fretless Bass
192	89	0	0	37	GM Slap Bass 1
193	90	0	0	38	GM Slap Bass 2
194	91	0	0	39	GM Synth Bass 1
195	92	0	0	40	GM Synth Bass 2

Voice List

Voice No.	Order in category	Bank Select		MIDI Program Change (1–128)	Voice Name
		MSB (0–127)	LSB (0–127)		
STRINGS					
196	1	0	116	50	Live! Orchestra
197	2	0	114	49	Symphony Strings
198	3	0	113	50	Slow Strings
199	4	0	122	50	Live! Allegro
200	5	0	113	49	Orchestra Strings
201	6	0	116	49	Spiccato
202	7	0	112	49	String Ensemble
203	8	0	115	49	String Ensemble2
204	9	0	112	50	Chamber Strings
205	10	0	3	49	Stereo Strings
206	11	0	45	49	Velocity Strings
207	12	0	112	45	Tremolo Strings
208	13	0	117	49	Tron Strings
209	14	0	112	51	Synth Strings
210	15	0	112	46	Pizzicato Strings
211	16	0	112	41	Violin
212	17	0	112	43	Cello
213	18	0	112	44	Contrabass
214	19	0	112	47	Harp
215	20	0	112	56	Orchestra Hit
216	21	0	64	56	Impact
217	22	0	40	49	Orchestra
218	23	0	0	41	GM Violin
219	24	0	0	42	GM Viola
220	25	0	0	43	GM Cello
221	26	0	0	44	GM Contrabass
222	27	0	0	45	GM Tremolo Str
223	28	0	0	46	GM Pizzicato Str
224	29	0	0	47	GM Orch Harp
225	30	0	0	49	GM Strings 1
226	31	0	0	50	GM Strings 2
227	32	0	0	51	GM Synth Strings 1
228	33	0	0	52	GM Synth Strings 2
229	34	0	0	56	GM Orchestra Hit
BRASS					
230	1	0	117	63	Live! Pop Brass
231	2	0	116	63	Live! Octave Brass
232	3	0	125	62	Sforzando Brass
233	4	0	118	62	Pop Brass
234	5	0	112	62	Brass Section
235	6	0	113	62	Big Band Brass
236	7	0	119	62	Mellow Horns
237	8	0	112	64	Big Syn
238	9	0	113	64	Ober Brass
239	10	0	114	64	Ober Horns
240	11	0	115	64	Big Squish
241	12	0	116	64	After 1984
242	13	0	117	64	Timeless
243	14	0	118	64	Kustom
244	15	0	113	63	80's Brass
245	16	0	114	63	Techno Brass
246	17	0	112	63	Synth Brass
247	18	0	119	64	Hard Saw Brass
248	19	0	120	64	Syn Saw Brass
249	20	0	115	57	Sweet! Trumpet
250	21	0	112	57	Trumpet

Voice No.	Order in category	Bank Select		MIDI Program Change (1–128)	Voice Name
		MSB (0–127)	LSB (0–127)		
251	22	0	112	60	Muted Trumpet
252	23	0	112	58	Trombone
253	24	0	113	58	Trombone Section
254	25	0	112	61	French Horn
255	26	0	112	59	Tuba
256	27	0	117	67	Sweet! Tenor Sax
257	28	0	113	65	Sweet! Soprn Sax
258	29	0	112	67	Tenor Sax
259	30	0	112	66	Alto Sax
260	31	0	112	65	Soprano Sax
261	32	0	112	68	Baritone Sax
262	33	0	114	67	Breathy Tenor Sax
263	34	0	112	72	Clarinet
264	35	0	112	69	Oboe
265	36	0	112	70	English Horn
266	37	0	112	71	Bassoon
267	38	0	114	74	Sweet! Flute
268	39	0	113	76	Sweet! Pan Flute
269	40	0	112	74	Flute
270	41	0	113	74	Tron Flute
271	42	0	112	73	Piccolo
272	43	0	112	76	Pan Flute
273	44	0	112	75	Recorder
274	45	0	112	80	Ocarina
275	46	0	0	57	GM Trumpet
276	47	0	0	58	GM Trombone
277	48	0	0	59	GM Tuba
278	49	0	0	60	GM Muted Trumpet
279	50	0	0	61	GM French Horn
280	51	0	0	62	GM Brass Section
281	52	0	0	63	GM Synth Brass 1
282	53	0	0	64	GM Synth Brass 2
283	54	0	0	65	GM Soprano Sax
284	55	0	0	66	GM Alto Sax
285	56	0	0	67	GM Tenor Sax
286	57	0	0	68	GM Baritone Sax
287	58	0	0	69	GM Oboe
288	59	0	0	70	GM English Horn
289	60	0	0	71	GM Bassoon
290	61	0	0	72	GM Clarinet
291	62	0	0	73	GM Piccolo
292	63	0	0	74	GM Flute
293	64	0	0	75	GM Recorder
294	65	0	0	76	GM Pan Flute
295	66	0	0	77	GM Blown Bottle
296	67	0	0	78	GM Shakuhachi
297	68	0	0	79	GM Whistle
298	69	0	0	80	GM Ocarina
SYNTH LEAD/PAD					
299	1	0	112	83	Mini Three
300	2	0	112	84	Punch Lead
301	3	0	112	87	Trojan
302	4	0	112	88	Crying
303	5	0	114	86	Flange Filter
304	6	0	115	84	Big LFO
305	7	0	112	85	Funky Pulse
306	8	0	115	86	Dynamic Mini

Voice No.	Order in category	Bank Select		MIDI Program Change (1-128)	Voice Name
		MSB (0-127)	LSB (0-127)		
307	9	0	114	85	Simple Oct1
308	10	0	114	84	Simple Oct2
309	11	0	116	81	Prog Lead
310	12	0	114	88	Galaga
311	13	0	115	88	Reso Lead
312	14	0	115	87	Cosmeter
313	15	0	116	82	Gus Lead
314	16	0	115	81	Dancy Hook
315	17	0	115	96	W Phaser
316	18	0	113	91	Big Lead
317	19	0	115	95	Faaat Dance
318	20	0	115	85	Power Lead
319	21	0	119	82	Fargo
320	22	0	113	83	Mr.Finger
321	23	0	113	84	Mini Soft
322	24	0	115	82	Analogon
323	25	0	113	85	Lucky
324	26	0	113	86	Inda Night
325	27	0	114	87	Sky Walk
326	28	0	113	81	Early Lead
327	29	0	113	82	Soft RnB
328	30	0	116	83	Poly Lead
329	31	0	115	83	Orbit Sine
330	32	0	116	84	Square Lead 1
331	33	0	112	81	Square Lead 2
332	34	0	112	82	Sawtooth Lead
333	35	0	6	82	Sawtooth Lead 2
334	36	0	8	82	Thick Sawtooth
335	37	0	112	84	Index Finger
336	38	0	117	83	Digi Moon
337	39	0	115	82	Dry Growl
338	40	0	115	95	Sync Faaat
339	41	0	116	87	Mode Reverse
340	42	0	113	87	Slap Spit
341	43	0	114	83	Cheap Tech
342	44	0	116	84	Standard Square
343	45	0	112	94	The Synth
344	46	0	112	96	Vapor
345	47	0	115	94	VP Soft
346	48	0	112	90	X-Shower
347	49	0	115	92	Light Pad
348	50	0	115	93	Noble Pad
349	51	0	112	91	Analog
350	52	0	112	93	Square
351	53	0	113	92	Dark Light
352	54	0	113	93	Sine Pad
353	55	0	113	94	Air Hose
354	56	0	114	91	Mid Range
355	57	0	114	92	LPF Sweep
356	58	0	114	93	Sharp Teeth
357	59	0	114	96	Da Pad
358	60	0	115	89	LFO Pad
359	61	0	113	95	Chorus Pad
360	62	0	113	96	Basic Pad
361	63	0	114	89	Ice Rink
362	64	0	114	90	Back Pad
363	65	0	114	94	Sweep Pad

Voice No.	Order in category	Bank Select		MIDI Program Change (1-128)	Voice Name
		MSB (0-127)	LSB (0-127)		
364	66	0	114	95	Slow LFO Pad
365	67	0	112	95	Equinox
366	68	0	113	90	Dark Moon
367	69	0	115	90	Landing Pad
368	70	0	115	91	Sand Pad
369	71	0	112	103	Amb Pad
370	72	0	113	89	Digi Stuff far
371	73	0	113	98	Neo Crystal
372	74	0	112	89	Fantasia
373	75	0	112	97	Glass Arp
374	76	0	112	99	Star Dust
375	77	0	113	101	Bell Pad
376	78	0	42	99	Chorus Bells
377	79	0	112	53	Choir
378	80	0	113	53	Vocal Ensemble
379	81	0	66	92	Itopia
380	82	0	112	55	Air Choir
381	83	0	112	86	Voice Lead
382	84	0	64	55	Analog Voice
383	85	0	112	92	Xenon Pad
384	86	0	112	54	Vox Humana
385	87	0	117	86	Big Comp
386	88	0	117	87	Light Comp
387	89	0	116	87	Short Pulse
388	90	0	116	88	Chord Seq 1
389	91	0	117	81	Chord Seq 2
390	92	0	117	82	Digital Seq
391	93	0	117	83	Hollow Seq
392	94	0	118	86	Snap Seq
393	95	0	96	82	Analog Seq
394	96	0	117	88	Trance Seq 1
395	97	0	118	81	Trance Seq 2
396	98	0	118	82	Trance Seq 3
397	99	0	114	83	Tech Comp
398	100	0	116	85	Quick Punch
399	101	0	117	85	Poly Master
400	102	0	118	83	Trancy
401	103	0	117	84	Silk Road
402	104	0	116	86	Rezz Punch
403	105	0	113	99	Sine Comp
404	106	0	118	84	Amb Sine
405	107	0	115	113	Clack Bell
406	108	0	118	85	Pulse Stop
407	109	0	113	103	Mystery Sine
408	110	0	118	87	Stroll
409	111	0	118	88	FM Metal
410	112	0	119	81	FS Buzz
411	113	0	119	83	Digi Osc
412	114	0	119	84	Bleep
413	115	0	112	98	Twist
414	116	0	112	100	Zen
415	117	0	112	102	Landscape
416	118	0	113	97	Meow Pad
417	119	0	113	100	Mind Bell
418	120	0	113	102	Rebirth '70
419	121	0	0	97	GM Rain
420	122	0	0	98	GM Sound Track

Voice List

Voice No.	Order in category	Bank Select		MIDI Program Change (1–128)	Voice Name
		MSB (0–127)	LSB (0–127)		
421	123	0	0	99	GM Crystal
422	124	0	0	100	GM Atmosphere
423	125	0	0	101	GM Brightness
424	126	0	0	102	GM Goblins
425	127	0	0	103	GM Echoes
426	128	0	0	104	GM Sci-Fi
427	129	0	0	81	GM Square Lead
428	130	0	0	82	GM Sawtooth Lead
429	131	0	0	83	GM Calliope Lead
430	132	0	0	84	GM Chiff Lead
431	133	0	0	85	GM Charang Lead
432	134	0	0	86	GM Voice Lead
433	135	0	0	87	GM Fifths Lead
434	136	0	0	88	GM Bass & Lead
435	137	0	0	89	GM New Age Pad
436	138	0	0	90	GM Warm Pad
437	139	0	0	91	GM Poly Synth Pad
438	140	0	0	92	GM Choir Pad
439	141	0	0	53	GM Choir Aahs
440	142	0	0	54	GM Voice Oohs
441	143	0	0	55	GM Synth Voice
442	144	0	0	93	GM Bowed Pad
443	145	0	0	94	GM Metallic Pad
444	146	0	0	95	GM Halo Pad
445	147	0	0	96	GM Sweep Pad
DRUM/PERC/SE					
446	1	127	0	81	Standard Kit
447	2	127	0	82	Analog T8 Kit
448	3	127	0	83	Analog T9 Kit
449	4	127	0	84	Break Kit
450	5	127	0	85	Hip Hop Kit
451	6	126	0	41	Afro Cuban Kit
452	7	126	0	44	Pop Latin kit
453	8	127	0	28	Dance Kit1
454	9	126	0	37	Arab.Kit
455	10	126	0	40	Indian Kit
456	11	127	0	128	Chinese Kit
457	12	127	0	1	GM Standard Kit 1
458	13	127	0	2	Standard Kit 2
459	14	127	0	9	Room Kit
460	15	127	0	17	Rock Kit
461	16	127	0	25	Electronic Kit
462	17	127	0	26	Analog Kit
463	18	127	0	113	Dance Kit2
464	19	127	0	33	Jazz Kit
465	20	127	0	41	Brush Kit
466	21	127	0	49	Symphony Kit
467	22	126	0	1	SFX Kit 1
468	23	126	0	2	SFX Kit 2
469	24	126	0	40	Under Street
470	25	127	0	83	Perc Loop
471	26	0	112	122	Ghost
472	27	0	112	123	Haunted
473	28	0	112	124	Volcano
474	29	0	112	125	Laser Beam
475	30	0	112	126	Lo-Fi Looper
476	31	0	112	127	U.F.O. Takeoff

Voice No.	Order in category	Bank Select		MIDI Program Change (1–128)	Voice Name
		MSB (0–127)	LSB (0–127)		
477	32	0	112	104	Warp Alert
478	33	0	112	128	Whale Dreams
479	34	0	112	121	Strange Hit
480	35	0	113	121	Noise Perc
481	36	0	113	122	Noise Fx
482	37	0	113	123	El Perc 1
483	38	0	113	124	El Perc 2
484	39	0	113	124	Elec Samba
485	40	0	113	125	Mini Blips
486	41	0	113	126	Hi Q 1
487	42	0	113	127	Hi Q 2
488	43	0	113	128	Radio Nz
489	44	64	0	1	Cutting Noise
490	45	64	0	2	Cutting Noise 2
491	46	64	0	4	String Slap
492	47	64	0	17	Flute Key Click
493	48	64	0	33	Shower
494	49	64	0	34	Thunder
495	50	64	0	35	Wind
496	51	64	0	36	Stream
497	52	64	0	37	Bubble
498	53	64	0	38	Feed
499	54	64	0	49	Dog
500	55	64	0	50	Horse
501	56	64	0	51	Bird Tweet
502	57	64	0	56	Maou
503	58	64	0	65	Phone Call
504	59	64	0	66	Door Squeak
505	60	64	0	67	Door Slam
506	61	64	0	68	Scratch Cut
507	62	64	0	69	Scratch Split
508	63	64	0	70	Wind Chime
509	64	64	0	71	Telephone Ring
510	65	64	0	81	Car Engine Ignition
511	66	64	0	82	Car Tires Squeal
512	67	64	0	83	Car Passing
513	68	64	0	84	Car Crash
514	69	64	0	85	Siren
515	70	64	0	86	Train
516	71	64	0	87	Jet Plane
517	72	64	0	88	Starship
518	73	64	0	89	Burst
519	74	64	0	90	Roller Coaster
520	75	64	0	91	Submarine
521	76	64	0	97	Laugh
522	77	64	0	98	Scream
523	78	64	0	99	Punch
524	79	64	0	100	Heartbeat
525	80	64	0	101	Footsteps
526	81	64	0	113	Machine Gun
527	82	64	0	114	Laser Gun
528	83	64	0	115	Explosion
529	84	64	0	116	Firework
530	85	0	0	116	GM Woodblock
531	86	0	0	117	GM Taiko Drum
532	87	0	0	118	GM Melodic Tom
533	88	0	0	119	GM Synth Drum

Voice No.	Order in category	Bank Select		MIDI Program Change (1–128)	Voice Name
		MSB (0–127)	LSB (0–127)		
534	89	0	0	120	GM Revers Cymbal
535	90	0	0	121	GM Fret Noise
536	91	0	0	122	GM Breath Noise
537	92	0	0	123	GM Seashore
538	93	0	0	124	GM Bird Tweet
539	94	0	0	125	GM Telephone Ring
540	95	0	0	126	GM Helicopter
541	96	0	0	127	GM Applause
542	97	0	0	128	GM Gunshot
ETHNIC					
543	1	0	113	108	Kanoun
544	2	0	113	78	Kawala
545	3	0	113	106	Oud 1
546	4	0	98	106	Oud 2
547	5	0	116	112	Mizmar
548	6	0	119	49	Wataryat
549	7	0	96	111	Er Hu
550	8	0	99	106	Pi Pa
551	9	0	98	16	Yang Qin
552	10	0	98	111	Jing Hu
553	11	0	97	111	Ban Hu
554	12	0	98	108	Zheng
555	13	0	96	110	Sheng
556	14	0	98	112	Suo Na
557	15	0	112	106	Banjo
558	16	0	114	113	Asian Bell
559	17	0	96	113	Bonang
560	18	0	98	115	Thai Bells
561	19	0	32	105	Detuned Sitar
562	20	0	0	105	GM Sitar
563	21	0	0	106	GM Banjo
564	22	0	0	107	GM Shamisen
565	23	0	0	108	GM Koto
566	24	0	0	109	GM Kalimba
567	25	0	0	110	GM Bagpipe
568	26	0	0	111	GM Fiddle
569	27	0	0	112	GM Shanai

Drum Kit List

- “ ” indicates that the drum sound is the same as “GM Standard Kit 1”.
- Each percussion voice uses one note.
- The MIDI Note # and Note are actually one octave lower than keyboard Note # and Note. For example, in “128: Standard Kit 1”, the “Seq Click H” (Note# 36/Note C1) corresponds to (Note# 24/Note C0).
- Key Off: Keys marked “O” stop sounding the instant they are released.
- Voices with the same Alternate Note Number (*1 ... 4) cannot be played simultaneously. (They are designed to be played alternately with each other.)

		Voice No.				12		1		2		3		4	
		MSB(0-127)/LSB(0-127)/PC(1-128)				127/000/001		127/000/081		127/000/082		127/000/083		127/000/084	
		Keyboard		MIDI		GM Standard Kit 1		Standard Kit		Analog T8 Kit		Analog T9 Kit		Break Kit	
		Note No.	Note	Note No.	Note	Key off	Alternate Group	Key off	Alternate Group	Key off	Alternate Group	Key off	Alternate Group	Key off	Alternate Group
C#0		25	C# 0	13	C# -1										
D0		26	D 0	14	D -1										
E0		27	D# 0	15	D# -1										
F0		28	E 0	16	E -1										
G0		29	F 0	17	F -1										
A0		30	F# 0	18	F# -1										
B0		31	G 0	19	G -0										
C#1		32	G# 0	20	G# -1										
D#1		33	A 0	21	A -1										
E#1		34	A# 0	22	A# -1										
F#1		35	B 0	23	B -1										
G#1		36	C 1	24	C 0										
A#1		37	C# 1	25	C# 0										
B#1		38	D 1	26	D 0										
C#2		39	D# 1	27	D# 0										
D#2		40	E 1	28	E 0										
F#2		41	F 1	29	F 0										
G#2		42	F# 1	30	F# 0										
A#2		43	G 1	31	G 0										
B#2		44	G# 1	32	G# 0										
C#3		45	A 1	33	A 0										
D#3		46	A# 1	34	A# 0										
E#3		47	B 1	35	B 0										
F#3		48	C 2	36	C 1										
G#3		49	C# 2	37	C# 1										
A#3		50	D 2	38	D 1										
B#3		51	D# 2	39	D# 1										
C#4		52	E 2	40	E 1										
D#4		53	F 2	41	F 1										
E#4		54	F# 2	42	F# 1										
F#4		55	G 2	43	G 1										
G#4		56	G# 2	44	G# 1										
A#4		57	A 2	45	A 1										
B#4		58	A# 2	46	A# 1										
C#5		59	B 2	47	B 1										
D#5		60	C 3	48	C 2										
E#5		61	C# 3	49	C# 2										
F#5		62	D 3	50	D 2										
G#5		63	D# 3	51	D# 2										
A#5		64	E 3	52	E 2										
B#5		65	F 3	53	F 2										
C#6		66	F# 3	54	F# 2										
D#6		67	G 3	55	G 2										
E#6		68	G# 3	56	G# 2										
F#6		69	A 3	57	A 2										
G#6		70	A# 3	58	A# 2										
A#6		71	B 3	59	B 2										
B#6		72	C 4	60	C 3										
C#7		73	C# 4	61	C# 3										
D#7		74	D 4	62	D 3										
E#7		75	D# 4	63	D# 3										
F#7		76	E 4	64	E 3										
G#7		77	F 4	65	F 3										
A#7		78	F# 4	66	F# 3										
B#7		79	G 4	67	G 3										
C#8		80	G# 4	68	G# 3										
D#8		81	A 4	69	A 3										
E#8		82	A# 4	70	A# 3										
F#8		83	B 4	71	B 3										
G#8		84	C 5	72	C 4										
A#8		85	C# 5	73	C# 4										
B#8		86	D 5	74	D 4										
C#9		87	D# 5	75	D# 4										
D#9		88	E 5	76	E 4										
E#9		89	F 5	77	F 4										
F#9		90	F# 5	78	F# 4										
G#9		91	G 5	79	G 4										
A#9		92	G# 5	80	G# 4										
B#9		93	A 5	81	A 4										
C#10		94	A# 5	82	A# 4										
D#10		95	B 5	83	B 4										
E#10		96	C 6	84	C 5										
F#10		97	C# 6	85	C# 5										
G#10		98	D 6	86	D 5										
A#10		99	D# 6	87	D# 5										
B#10		100	E 6	88	E 5										
C#11		101	F 6	89	F 5										
D#11		102	F# 6	90	F# 5										
E#11		103	G 6	91	G 5										

		Voice No.				12		5		6		7		8	
		MSB(0-127)/LSB(0-127)/PC(1-128)				127/000/001		127/000/085		126/000/041		126/000/044		127/000/028	
		Keyboard		MIDI		GM Standard Kit 1		Hip Hop Kit		AfroCuban Kit		Pop Latin kit		Dance Kit1	
		Note No.	Note	Note No.	Note	Key off	Alternate Group	Key off	Alternate Group	Key off	Alternate Group	Key off	Alternate Group	Key off	Alternate Group
C#0	D0	25	C# 0	13	C# -1	Surdo Mute	3		5						Kick Dance 1
D#0	E0	26	D 0	14	D -1	Surdo Open	3		5						Kick Dance 2
	F0	27	D# 0	15	D# -1	Hi Q									Hi Q Dance 2
	G0	28	E 0	16	E -1	Whip Slap									Hi Q Dance 3
	A#0	29	F 0	17	F -1	Scratch H	4		6						Scratch Dance 1
	B0	30	F# 0	18	F# -1	Scratch L	4		6						Scratch Dance 2
	C1	31	G 0	19	G -1	Finger Snap		Hi-Hat Closed T8 2				Hand Clap			
	D#1	32	G# 0	20	G# -1	Click Noise		Tom T8 3							
	E1	33	A 0	21	A -1	Metronome Click		Hi-Hat Open T8 2	4						Dance Percussion 1
	F#1	34	A# 0	22	A# -1	Metronome Bell		Tom T8 6		Conga H Tip		Conga H Tip			Reverse Dance 1
	G#1	35	B 0	23	B -1	Seq Click L		Crash T8		Conga H Heel		Conga H Heel			Dance Percussion 2
	A#1	36	C 1	24	C 0	Seq Click H		Triangle Mute	1	Conga H Open		Conga H Open			Hi Q Dance 1
	B1	37	C# 1	25	C# 0	Brush Tap		Triangle Open	1	Conga H Mute		Conga H Mute			Snare Analog 3
	C2	38	D 1	26	D 0	Brush Swirl	O	Bell Tree		Conga H Slap Open		Conga H Slap Open			Vinyl Noise
	D#2	39	D# 1	27	D# 0	Brush Slap		Tambourine RX5		Conga H Slap		Conga H Slap			Snare Analog 4
	E2	40	E 1	28	E 0	Brush Tap Swirl	O	Tambourine RX5 2		Conga H Slap Mute		Conga H Slap Mute			Reverse Cymbal
	F#2	41	F 1	29	F 0	Snare Roll	O	Kick HipHop9		Conga L Slap		Conga L Slap			Reverse Dance 2
	G#2	42	F# 1	30	F# 0	Castanet		Hi-Hat Closed Tek	3	Conga L Heel		Conga L Heel			Hi Q 2
	A#2	43	G 1	31	G 0	Snare Soft		Kick Gate		Conga L Open		Conga L Open			Snare Techno
	B2	44	G# 1	32	G# 0	Sticks		Hi-Hat Open Lo-Fi	3	Conga L Mute		Conga L Mute			Snare Dance 1
	C3	45	A 1	33	A 0	Kick Soft		Kick Gran Casa Open		Conga L Slap Open		Conga L Slap Open			Kick Techno Q
	D#3	46	A# 1	34	A# 0	Open Rim Shot		Hi-Hat Reverse D&B		Conga L Slap		Conga L Slap			Rim Gate
	E3	47	B 1	35	B 0	Kick Tight		Kick HipHop1		Conga L Slide	O	Conga L Slide	O		Kick Techno L
	F#3	48	C 2	36	C 1	Kick		Kick AnCR		Bongo H Open 1 finger		Bongo H Open 1 finger			Kick Techno
	G#3	49	C# 2	37	C# 1	Side Stick		Snare AnSm Rim		Bongo H Open 3 finger		Bongo H Open 3 finger			Side Stick Analog
	A#3	50	D 2	38	D 1	Snare		Snare HipHop1		Bongo H Rim		Bongo H Rim			Snare Clap
	B3	51	D# 2	39	D# 1	Hand Clap		Snare Clappy		Bongo H Tip		Bongo H Tip			Dance Clap
	C4	52	E 2	40	E 1	Snare Tight		Snare HipHop2		Bongo H Heel		Bongo H Heel			Snare Dry
	D#4	53	F 2	41	F 1	Floor Tom L		Floor Tom L		Bongo H Slap		Bongo H Slap			Tom Analog 1
	E4	54	F# 2	42	F# 1	Hi-Hat Closed	1	Hi-Hat Closed Hip	2	Bongo L Open 1 finger		Bongo L Open 1 finger			Hi-Hat Closed Analog3
	F#4	55	G 2	43	G 1	Floor Tom H		Low Tom		Bongo L Open 3 finger		Bongo L Open 3 finger			Tom Analog 2
	G#4	56	G# 2	44	G# 1	Hi-Hat Pedal	1	Hi-Hat Pedal Hip	2	Bongo L Rim		Bongo L Rim			Hi-Hat Closed Analog 4
	A#4	57	A 2	45	A 1	Low Tom		Mid Tom L		Bongo L Tip		Bongo L Tip			Tom Analog 3
	B4	58	A# 2	46	A# 1	Hi-Hat Open	1	Hi-Hat Open Hip	2	Bongo L Heel		Bongo L Heel			Hi-Hat Open Analog 2
	C5	59	B 2	47	B 1	Mid Tom L		Mid Tom L		Bongo L Slap		Bongo L Slap			Tom Analog 4
	D#5	60	C 3	48	C 2	Mid Tom H		Ride Cymbal 3		Timbale L Open		Timbale L Open			Tom Analog 5
	E5	61	C# 3	49	C# 2	Crash Cymbal 1		Crash Cymbal 3							Crash Analog
	F#5	62	D 3	50	D 2	High Tom		Shaker 2							Tom Analog 6
	G#5	63	D# 3	51	D# 2	Ride Cymbal 1		Scratch Bd F							
	A#5	64	E 3	52	E 2	Chinese Cymbal		Scratch Bd R							
	B#5	65	F 3	53	F 2	Ride Cymbal Cup		Kick HipHop2		Paila L		Paila L			
	C6	66	F# 3	54	F# 2	Tambourine		Snare HipHop Rim2		Timbale H Open		Timbale H Open			Tambourine Analog
	D#6	67	G 3	55	G 2	Splash Cymbal		HipHop clap2							
	E#6	68	G# 3	56	G# 2	Cowbell		HipHop Snap1							Cowbell Analog
	F#6	69	A 3	57	A 2	Crash Cymbal 2		Snare HipHop3							
	G#6	70	A# 3	58	A# 2	Vibraslap		Electric Clap2							Vibraslap Analog
	A#6	71	B 3	59	B 2	Ride Cymbal 2		Kick Hip Deep		Paila H		Paila H			Ride Analog
	B#6	72	C 4	60	C 3	Bongo H		Kick HipHop3		Cowbell Top		Cowbell Top			Bongo Analog H
	C#6	73	C# 4	61	C# 3	Bongo L		Snare HipHop Rim3							Bongo Analog L
	D#6	74	D 4	62	D 3	Conga H Mute		Snare HipHop5							Conga Analog H
	E#6	75	D# 4	63	D# 3	Conga H Open		Electric Clap 1							Conga Analog M
	F#6	76	E 4	64	E 3	Conga L		Handbell H		Guiro Short		Guiro Short			Conga Analog L
	G#6	77	F 4	65	F 3	Timbale H		Kick HipHop4		Guiro Long	O	Guiro Long	O		
	A#6	78	F# 4	66	F# 3	Timbale L		HipHop clap3							
	B#6	79	G 4	67	G 3	Agogo H		HipHop Snap2							
	C#6	80	G# 4	68	G# 3	Agogo L		Snare HipHop Rim5		Tambourine		Tambourine			
	D#6	81	A 4	69	A 3	Cabasa		HipHop flex1							
	E#6	82	A# 4	70	A# 3	Maracas		HipHop flex2							Maracas 2
	F#6	83	B 4	71	B 3	Samba Whistle H	O	Shaker 2							
	G#6	84	C 5	72	C 4	Samba Whistle L	O	Kick HipHop5		Maracas		Maracas			
	A#6	85	C# 5	73	C# 4	Guiro Short		Snare HipHop Rim4		Shaker		Shaker			
	B#6	86	D 5	74	D 4	Guiro Long	O	Snare HipHop6		Cabasa		Cabasa			
	C#6	87	D# 5	75	D# 4	Claves		Snare HipHop11				Cuica Mute			Claves 2
	D#6	88	E 5	76	E 4	Wood Block H		Kick HipHop10				Cuica Open			Dance Percussion 3
	E#6	89	F 5	77	F 4	Wood Block L		Snare HipHop7							Dance Percussion 4
	F#6	90	F# 5	78	F# 4	Cuica Mute		HipHop clap5							Dance Breath 1
	G#6	91	G 5	79	G 4	Cuica Open		Conga H Tip							Dance Breath 2
	A#6	92	G# 5	80	G# 4	Triangle Mute	2	Conga H Heel							
	B#6	93	A 5	81	A 4	Triangle Open	2	Conga L Open				Triangle Mute	1		
	C#6	94	A# 5	82	A# 4	Shaker		Conga L Open 1				Triangle Open	1		
	D#6	95	B 5	83	B 4	Jingle Bells		Conga L Open 2							
	E#6	96	C 6	84	C 5	Bell Tree		Kick HipHop8				Bell Tree			
	F#6	97	C# 6	85	C# 5			HipHop clap6							
	G#6	98	D 6	86	D 5			Snare T8 1							
	A#6	99	D# 6	87	D# 5			Snare T8 1 H							
	B#6	100	E 6	88	E 5			HipHop clap7							
	C#6	101	F 6	89	F 5			Tom T8 1							
	D#6	102	F# 6	90	F# 5			Hi-Hat Closed T8 2							
	E#6	103	G 6	91	G 5			Tom T8 2							

Drum Kit List

		Voice No.		12		9		10		11		13			
		MSB(0-127)/LSB(0-127)/PC(1-128)		127/000/001		126/000/037		126/000/040		127/000/128		127/000/002			
		Keyboard		MIDI		GM Standard Kit 1		Arab.Kit		Indian Kit		Chinese Kit		Standard Kit 2	
		Note No.	Note	Note No.	Note	Key off	Alternate Group	Key off	Alternate Group	Key off	Alternate Group	Key off	Alternate Group	Key off	Alternate Group
C#0	25	C# 0	13	C# -1	Surdo Mute		3	Zarb Back mf							3
D0	26	D 0	14	D -1	Surdo Open		3	Zarb Tom f					2		3
E0	27	D# 0	15	D# -1	Hi Q			Zarb Eshareh					2		3
F0	28	E 0	16	E -1	Whip Slap			Zarb Whipping							
G0	29	F 0	17	F -1	Scratch H		4	Tombak Tom f					3		4
A0	30	F# 0	18	F# -1	Scratch L		4	Neghareh Tom f					3		4
B0	31	G 0	19	G -1	Finger Snap			Tombak Back f							
C#1	32	G# 0	20	G# -1	Click Noise			Neghareh Back f							
D#1	33	A 0	21	A -1	Metronome Click			Tombak Snap f							
E#1	34	A# 0	22	A# -1	Metronome Bell			Neghareh Pelang f							
F#1	35	B 0	23	B -1	Seq Click L			Tombak Trill	O		Hateli_Short				
G#1	36	C 1	24	C	Seq Click H			Khaligi Clap 1		1	Baya_ge				
A#1	37	C# 1	25	C#	Brush Tap			Zalgouta Open	O	1	Baya_ke				
B#1	38	D 1	26	D	Brush Swirl	O		Khaligi Clap 2		1	Baya_ghe		1		O
C#2	39	D# 1	27	D#	Brush Slap			Zalgouta Close		1	Baya_ka		O		O
D#2	40	E 1	28	E	Brush Tap Swirl	O		Arabic Hand Clap		2	Tabla_na		O		O
E#2	41	F 1	29	F	Snare Roll	O		Tabel Tak 1		2	Tabla_tin		O		O
F#2	42	F# 1	30	F#	Castanet			Sagat 1		1	Tablabaya_dha				
G#2	43	G 1	31	G	Snare Soft			Tabel Dom		2	Tabla_tun				Snare Soft 2
A#2	44	G# 1	32	G#	Sticks			Sagat 2		1	Tablabaya_dhin				
B#2	45	A 1	33	A	Kick Soft			Tabel Tak 2		2	Tabla_di				
C#3	46	A# 1	34	A#	Open Rim Shot			Sagat 3		1	Tablabaya_dhe				Open Rim Shot H Short
D#3	47	B 1	35	B	Kick Tight			Riq Tik 3		2	Tabla_ti				Kick Tight Short
E#3	48	C 2	36	C	Kick			Riq Tik 2		2	Tabla_ne				Kick Short
F#3	49	C# 2	37	C#	Side Stick			Riq Tik Hard 1		2	Tabla_taran				
G#3	50	D 2	38	D	Snare			Riq Tik 1		2	Tabla_tak				Snare Short
A#3	51	D# 2	39	D#	Hand Clap			Riq Tik Hard 2			Chipri				
B#3	52	E 2	40	E	Snare Tight			Riq Tik Hard 3		3	Kanjira_open				Snare Tight H
C#4	53	F 2	41	F	Floor Tom L			Riq Tish		3	Kanjira_slap				
D#4	54	F# 2	42	F#	Hi-Hat Closed	1		Riq Snouj 2		3	Kanjira_mute		1		1
E#4	55	G 2	43	G	Floor Tom H			Riq Roll	O	3	Kanjira_bendup				
F#4	56	G# 2	44	G#	Hi-Hat Pedal	1		Riq Snouj		3	Kanjira_bendown		1		1
G#4	57	A 2	45	A	Low Tom			Riq Sak		4	Dholak_open				
A#4	58	A# 2	46	A#	Hi-Hat Open	1		Riq Snouj 3		4	Dholak_mute		1		1
B#4	59	B 2	47	B	Mid Tom L			Riq Snouj 4		4	Dholak_slap				
C#5	60	C 3	48	C	Mid Tom H			Riq Tak 1		5	Dhol_open				
D#5	61	C# 3	49	C#	Crash Cymbal 1			Riq Brass 1		5	Dhol_mute				
E#5	62	D 3	50	D	High Tom			Riq Tak 2		5	Dhol_slap				
F#5	63	D# 3	51	D#	Ride Cymbal 1			Riq Brass 2		5	Dhol_slide				
G#5	64	E 3	52	E	Chinese Cymbal			Riq Dom		6	Mridangam_normal				
A#5	65	F 3	53	F	Ride Cymbal Cup			Katem Tak Doff		6	Mridangam_open				
B#5	66	F# 3	54	F#	Tambourine			Katem Dom		6	Mridangam_mute				
C#6	67	G 3	55	G	Splash Cymbal			Katem Sak 1		6	Mridangam_slap				
D#6	68	G# 3	56	G#	Cowbell			Katem Tak 1		6	Mridangam_rim				
E#6	69	A 3	57	A	Crash Cymbal 2			Katem Sak 2		7	Chimta_open				
F#6	70	A# 3	58	A#	Vibraslap			Katem Tak 2		7	Chimta_normal				
G#6	71	B 3	59	B	Ride Cymbal 2			Daholla Sak 2		7	Chimta_ring				
A#6	72	C 4	60	C	Bongo H			Daholla Sak 1		8	Dholki_open				
B#6	73	C# 4	61	C#	Bongo L			Daholla Tak 1		8	Dholki_mute				
C#7	74	D 4	62	D	Conga H Mute			Daholla Dom		8	Dholki_slap				
D#7	75	D# 4	63	D#	Conga H Open			Daholla Tak 2		8	Dholki_slide				
E#7	76	E 4	64	E	Conga L			Tablah Prok		8	Dholki_rim				
F#7	77	F 4	65	F	Timbale H			Tablah dom 2		9	Khol_open				
G#7	78	F# 4	66	F#	Timbale L			Tablah Roll of Edge	O	9	Khol_slide				
A#7	79	G 4	67	G	Agogo H			Tablah Tak Finger 4		9	Khol_mute		4		Dagu Mute
B#7	80	G# 4	68	G#	Agogo L			Tablah Tak Trill 1		10	Manjira_open		5		Zhongcha Mute
C#8	81	A 4	69	A	Cabasa			Tablah Tak Finger 3		10	Manjira_cls		4		Dagu Heavy
D#8	82	A# 4	70	A#	Maracas			Tablah Tak Trill 2		11	Jhanji_open		5		Zhongcha Open
E#8	83	B 4	71	B	Samba Whistle H	O		Tablah Tak Finger 2		11	Jhanji_cls				Paigu Middle
F#8	84	C 5	72	C	Samba Whistle L	O		Tablah Tak Finger 1		12	Mondira_open				Paigu Low
G#8	85	C# 5	73	C#	Guiro Short			Tablah Tik 2		12	Mondira_close		6		Xiaocha Mute
A#8	86	D 5	74	D	Guiro Long	O		Tablah Tik 4		13	Mridang_open				Bangu
B#8	87	D# 5	75	D#	Claves			Tablah Tik 3		13	Mridang_mute		6		Xiaocha Open
C#9	88	E 5	76	E	Wood Block H			Tablah Tik 1		13	Mridang_rim				Bangzi
D#9	89	F 5	77	F	Wood Block L			Tablah Tak 3		13	Mridang_slide				Muyu Low
E#9	90	F# 5	78	F#	Cuica Mute			Tablah Tak 1			Khomokh_normal		7		Zhongluo Mute
F#9	91	G 5	79	G	Cuica Open			Tablah Tak 4			Khomokh_mute				Muyu Mid-Low
G#9	92	G# 5	80	G#	Triangle Mute		2	Tablah Tak 2			Khomokh_mltatk		7		Zhongluo Open
A#9	93	A 5	81	A	Triangle Open		2	Tablah Tak 2			Madal-A2				Muyu Middle
B#9	94	A# 5	82	A#	Shaker			Tablah Tremolo	O		Madal-A#2				Xiaolu Open
C#10	95	B 5	83	B	Jingle Bells			Tablah Sak 1			Madal-B2				Triangle Mute
D#10	96	C 6	84	C	Bell Tree			Tablah Dom 1			Madal-C3				Triangle Open
E#10	97	C# 6	85	C#							Madal-C#3				
F#10	98	D 6	86	D							Madal-D3				
G#10	99	D# 6	87	D#							Madal-D#3				
A#10	100	E 6	88	E							Madal-E3				
B#10	101	F 6	89	F							Madal-F3				
C#11	102	F# 6	90	F#							Madal-F#3				
D#11	103	G 6	91	G							Madal-G3				

Voice No.	12		14		15		16		17						
	MSB(0-127)/LSB(0-127)/PC(1-128)				127/000/001		127/000/009		127/000/017		127/000/025		127/000/026		
	Keyboard	MIDI	GM Standard Kit 1	Alternate Group	Room Kit	Key off	Alternate Group	Rock Kit	Key off	Alternate Group	Electronic Kit	Key off	Alternate Group	Analog Kit	Key off
C#0	25	C# 0	13	C# -1	Surdo Mute		3		3		3		3		3
D0	26	D 0	14	D -1	Surdo Open		3		3		3		3		3
E0	27	D# 0	15	D# -1	Hi Q										
F0	28	E 0	16	E -1	Whip Slap										
G0	29	F 0	17	F -1	Scratch H		4		4			4			4
A0	30	F# 0	18	F# -1	Scratch L		4		4			4			4
B0	31	G 0	19	G -1	Finger Snap										
C1	32	G# 0	20	G# -1	Click Noise										
D1	33	A 0	21	A -1	Metronome Click										
E1	34	A# 0	22	A# -1	Metronome Bell										
F1	35	B 0	23	B -1	Seq Click L										
G1	36	C 1	24	C 0	Seq Click H										
A1	37	C# 1	25	C# 0	Brush Tap										
B1	38	D 1	26	D 0	Brush Swirl	O			O			O			O
C2	39	D# 1	27	D# 0	Brush Slap										
D2	40	E 1	28	E 0	Brush Tap Swirl	O			O		Reverse Cymbal	O		Reverse Cymbal	O
E2	41	F 1	29	F 0	Snare Roll	O			O			O			O
F2	42	F# 1	30	F# 0	Castanet						Hi Q 2			Hi Q 2	
G2	43	G 1	31	G 0	Snare Soft			Snare Noisy			Snare Snappy Electro			Snare Noisy 4	
A2	44	G# 1	32	G# 0	Sticks										
B2	45	A 1	33	A 0	Kick Soft			Kick Tight 2			Kick 3			Kick Tight 2	
C3	46	A# 1	34	A# 0	Open Rim Shot										
D3	47	B 1	35	B 0	Kick Tight			Kick 2			Kick Gate			Kick Analog Short	
E3	48	C 2	36	C 1	Kick			Kick Gate			Kick Gate Heavy			Kick Analog	
F3	49	C# 2	37	C# 1	Side Stick									Side Stick Analog	
G3	50	D 2	38	D 1	Snare			Snare Snappy			Snare Noisy 2			Snare Analog	
A3	51	D# 2	39	D# 1	Hand Clap										
B3	52	E 2	40	E 1	Snare Tight			Snare Tight Snappy			Snare Noisy 3			Snare Analog 2	
C4	53	F 2	41	F 1	Floor Tom L			Tom Room 1			Tom Electro 1			Tom Analog 1	
D4	54	F# 2	42	F# 1	Hi-Hat Closed	1								Hi-Hat Closed Analog	1
E4	55	G 2	43	G 1	Floor Tom H			Tom Room 2			Tom Electro 2			Tom Analog 2	
F4	56	G# 2	44	G# 1	Hi-Hat Pedal	1								Hi-Hat Closed Analog 2	1
G4	57	A 2	45	A 1	Low Tom			Tom Room 3			Tom Electro 3			Tom Analog 3	
A4	58	A# 2	46	A# 1	Hi-Hat Open	1								Hi-Hat Open Analog	1
B4	59	B 2	47	B 1	Mid Tom L			Tom Room 4			Tom Electro 4			Tom Analog 4	
C5	60	C 3	48	C 2	Mid Tom H			Tom Room 5			Tom Electro 5			Tom Analog 5	
D5	61	C# 3	49	C# 2	Crash Cymbal 1									Crash Analog	
E5	62	D 3	50	D 2	High Tom			Tom Room 6			Tom Electro 6			Tom Analog 6	
F5	63	D# 3	51	D# 2	Ride Cymbal 1										
G5	64	E 3	52	E 2	Chinese Cymbal										
A5	65	F 3	53	F 2	Ride Cymbal Cup										
B5	66	F# 3	54	F# 2	Tambourine										
C6	67	G 3	55	G 2	Splash Cymbal										
D6	68	G# 3	56	G# 2	Cowbell									Cowbell Analog	
E6	69	A 3	57	A 2	Crash Cymbal 2										
F6	70	A# 3	58	A# 2	Vibraslap										
G6	71	B 3	59	B 2	Ride Cymbal 2										
A6	72	C 4	60	C 3	Bongo H										
B6	73	C# 4	61	C# 3	Bongo L										
C7	74	D 4	62	D 3	Conga H Mute									Conga Analog H	
D7	75	D# 4	63	D# 3	Conga H Open									Conga Analog M	
E7	76	E 4	64	E 3	Conga L									Conga Analog L	
F7	77	F 4	65	F 3	Timbale H										
G7	78	F# 4	66	F# 3	Timbale L										
A7	79	G 4	67	G 3	Agogo H										
B7	80	G# 4	68	G# 3	Agogo L										
C8	81	A 4	69	A 3	Cabasa										
D8	82	A# 4	70	A# 3	Maracas									Maracas 2	
E8	83	B 4	71	B 3	Samba Whistle H	O			O			O			O
F8	84	C 5	72	C 4	Samba Whistle L	O			O			O			O
G8	85	C# 5	73	C# 4	Guiro Short										
A8	86	D 5	74	D 4	Guiro Long	O			O			O			O
B8	87	D# 5	75	D# 4	Claves									Claves 2	
C9	88	E 5	76	E 4	Wood Block H										
D9	89	F 5	77	F 4	Wood Block L										
E9	90	F# 5	78	F# 4	Cuica Mute						Scratch H 2			Scratch H 2	
F9	91	G 5	79	G 4	Cuica Open						Scratch L 2			Scratch L 3	
G9	92	G# 5	80	G# 4	Triangle Mute	2			2				2		2
A9	93	A 5	81	A 4	Triangle Open	2			2				2		2
B9	94	A# 5	82	A# 4	Shaker										
C10	95	B 5	83	B 4	Jingle Bells										
D10	96	C 6	84	C 5	Bell Tree										
E10	97	C# 6	85	C# 5											
F10	98	D 6	86	D 5											
G10	99	D# 6	87	D# 5											
A10	100	E 6	88	E 5											
B10	101	F 6	89	F 5											
C11	102	F# 6	90	F# 5											
D11	103	G 6	91	G 5											

Drum Kit List

Voice No.	12				18				19				20							
	MSB(0-127)/LSB(0-127)/PC(1-128)				127/000/001				127/000/113				127/000/033				127/000/041			
	Keyboard		MIDI		GM Standard Kit 1		Key off	Alternate Group	Dance Kit2		Key off	Alternate Group	Jazz Kit		Key off	Alternate Group	Brush Kit		Key off	Alternate Group
Note No.	Note	Note No.	Note	Note No.	Note			Note No.	Note	Note No.	Note	Note No.	Note	Note No.	Note	Note No.	Note	Note No.	Note	
D0	C#0	25	C# 0	13	C# -1	Surdo Mute	3													
	D#0	26	D 0	14	D -1	Surdo Open	3													
E0		27	D# 0	15	D# -1	Hi Q														
F0		28	E 0	16	E -1	Whip Slap														
G0	F#0	29	F 0	17	F -1	Scratch H	4													
A0	G#0	30	F# 0	18	F# -1	Scratch L	4													
B0	A#0	31	G 0	19	G -1	Finger Snap														
C1		32	G# 0	20	G# -1	Click Noise														
D1	C#1	33	A 0	21	A -1	Metronome Click														
E1	D#1	34	A# 0	22	A# -1	Metronome Bell														
F1		35	B 0	23	B -1	Seq Click L														
G1	F#1	36	C 1	24	C 0	Seq Click H														
A1	G#1	37	C# 1	25	C# 0	Brush Tap														
B1	A#1	38	D 1	26	D 0	Brush Swirl	O			O								O		
C2	C#2	39	D# 1	27	D# 0	Brush Slap														
D2	D#2	40	E 1	28	E 0	Brush Tap Swirl	O		Reverse Cymbal	O				O					O	
E2	F#2	41	F 1	29	F 0	Snare Roll	O			O				O					O	
F2	G#2	42	F# 1	30	F# 0	Castanet			Hi Q 2											
G2	A#2	43	G 1	31	G 0	Snare Soft			Snare Techno				Snare Jazz H					Brush Slap 2		
A2		44	G# 1	32	G# 0	Sticks														
B2	C#3	45	A 1	33	A 0	Kick Soft			Kick Techno Q											
C3	D#3	46	A# 1	34	A# 0	Open Rim Shot			Rim Gate											
D3	F#3	47	B 1	35	B 0	Kick Tight			Kick Techno L											
E3	G#3	48	C 2	36	C 1	Kick			Kick Techno				Kick Jazz					Kick Small		
F3	A#3	49	C# 2	37	C# 1	Side Stick			Side Stick Analog											
G3	C#4	50	D 2	38	D 1	Snare			Snare Clap				Snare Jazz L					Brush Slap 3		
A3	D#4	51	D# 2	39	D# 1	Hand Clap														
B3	F#4	52	E 2	40	E 1	Snare Tight			Snare Dry				Snare Jazz M					Brush Tap 2		
C4	G#4	53	F 2	41	F 1	Floor Tom L			Tom Analog 1				Tom Jazz 1					Tom Brush 1		
D4	A#4	54	F# 2	42	F# 1	Hi-Hat Closed	1		Hi-Hat Closed Analog3	1				1					1	
E4	C#5	55	G 2	43	G 1	Floor Tom H			Tom Analog 2				Tom Jazz 2					Tom Brush 2		
F4	D#5	56	G# 2	44	G# 1	Hi-Hat Pedal	1		Hi-Hat Closed Analog 4	1				1					1	
G4	F#5	57	A 2	45	A 1	Low Tom			Tom Analog 3				Tom Jazz 3					Tom Brush 3		
A4	G#5	58	A# 2	46	A# 1	Hi-Hat Open	1		Hi-Hat Open Analog 2	1				1					1	
B4	C#6	59	B 2	47	B 1	Mid Tom L			Tom Analog 4				Tom Jazz 4					Tom Brush 4		
C5	D#6	60	C 3	48	C 2	Mid Tom H			Tom Analog 5				Tom Jazz 5					Tom Brush 5		
D5	F#6	61	C# 3	49	C# 2	Crash Cymbal 1			Crash Analog											
E5	G#6	62	D 3	50	D 2	High Tom			Tom Analog 6				Tom Jazz 6					Tom Brush 6		
F5	A#6	63	D# 3	51	D# 2	Ride Cymbal 1														
G5	C#7	64	E 3	52	E 2	Chinese Cymbal														
A5	D#7	65	F 3	53	F 2	Ride Cymbal Cup														
B5	F#7	66	F# 3	54	F# 2	Tambourine														
C6	G#7	67	G 3	55	G 2	Splash Cymbal														
D6	A#7	68	G# 3	56	G# 2	Cowbell			Cowbell Analog											
E6	C#8	69	A 3	57	A 2	Crash Cymbal 2														
F6	D#8	70	A# 3	58	A# 2	Vibraslap														
G6	F#8	71	B 3	59	B 2	Ride Cymbal 2														
A6	G#8	72	C 4	60	C 3	Bongo H														
B6	A#8	73	C# 4	61	C# 3	Bongo L														
C7	C#9	74	D 4	62	D 3	Conga H Mute			Conga Analog H											
D7	D#9	75	D# 4	63	D# 3	Conga H Open			Conga Analog M											
E7	F#9	76	E 4	64	E 3	Conga L			Conga Analog L											
F7	G#9	77	F 4	65	F 3	Timbale H														
G7	A#9	78	F# 4	66	F# 3	Timbale L														
A7	C#10	79	G 4	67	G 3	Agogo H														
B7	D#10	80	G# 4	68	G# 3	Agogo L														
C8	F#10	81	A 4	69	A 3	Cabasa														
D8	G#10	82	A# 4	70	A# 3	Maracas			Maracas 2											
E8	A#10	83	B 4	71	B 3	Samba Whistle H	O			O				O					O	
F8	C#11	84	C 5	72	C 4	Samba Whistle L	O			O				O					O	
G8	D#11	85	C# 5	73	C# 4	Guiro Short														
A8	F#11	86	D 5	74	D 4	Guiro Long	O			O				O					O	
B8	G#11	87	D# 5	75	D# 4	Claves			Claves 2											
C9	A#11	88	E 5	76	E 4	Wood Block H														
D9	C#12	89	F 5	77	F 4	Wood Block L														
E9	D#12	90	F# 5	78	F# 4	Cuica Mute			Scratch H 2											
F9	F#12	91	G 5	79	G 4	Cuica Open			Scratch L 3											
G9	G#12	92	G# 5	80	G# 4	Triangle Mute	2			2				2					2	
A9	A#12	93	A 5	81	A 4	Triangle Open	2			2				2					2	
B9	C#13	94	A# 5	82	A# 4	Shaker														
C10	D#13	95	B 5	83	B 4	Jingle Bells														
D10	F#13	96	C 6	84	C 5	Bell Tree														
E10	G#13	97	C# 6	85	C# 5															
F10	A#13	98	D 6	86	D 5															
G10	C#14	99	D# 6	87	D# 5															
	D#14	100	E 6	88	E 5															
	F#14	101	F 6	89	F 5															
	G#14	102	F# 6	90	F# 5															
	A#14	103	G 6	91	G 5															

	Voice No.	12		21			22			23					
		MSB(0-127)/LSB(0-127)/PC(1-128)		127/000/001			127/000/049			126/000/001			126/000/002		
		Keyboard	MIDI	GM Standard Kit 1	Key off	Alternate Group	Symphony Kit	Key off	Alternate Group	SFX Kit 1	Key off	Alternate Group	SFX Kit 2	Key off	Alternate Group
D0	C#0	25	C# 0	13	C# -1	Surdo Mute									
		26	D 0	14	D -1	Surdo Open									
E0	D#0	27	D# 0	15	D# -1	Hi Q									
		28	E 0	16	E -1	Whip Slap									
F0	F#0	29	F 0	17	F -1	Scratch H									
G0	G#0	30	F# 0	18	F# -1	Scratch L									
		31	G 0	19	G -1	Finger Snap									
A0	A#0	32	G# 0	20	G# -1	Click Noise									
B0		33	A 0	21	A -1	Metronome Click									
C1	C#1	34	A# 0	22	A# -1	Metronome Bell									
		35	B 0	23	B -1	Seq Click L									
D1	D#1	36	C 1	24	C 0	Seq Click H									
E1		37	C# 1	25	C# 0	Brush Tap									
F1	F#1	38	D 1	26	D 0	Brush Swirl	O			O					
G1	G#1	39	D# 1	27	D# 0	Brush Slap									
A1	A#1	40	E 1	28	E 0	Brush Tap Swirl	O			O					
B1		41	F 1	29	F 0	Snare Roll	O			O					
C2	C#2	42	F# 1	30	F# 0	Castanet									
D2	D#2	43	G 1	31	G 0	Snare Soft									
E2		44	G# 1	32	G# 0	Sticks									
F2	F#2	45	A 1	33	A 0	Kick Soft									
G2	G#2	46	A# 1	34	A# 0	Open Rim Shot									
A2	A#2	47	B 1	35	B 0	Kick Tight									
B2		48	C 2	36	C 1	Kick									
C3	C#3	49	C# 2	37	C# 1	Side Stick									
D3	D#3	50	D 2	38	D 1	Snare									
E3		51	D# 2	39	D# 1	Hand Clap									
F3	F#3	52	E 2	40	E 1	Snare Tight									
G3	G#3	53	F 2	41	F 1	Floor Tom L									
A3	A#3	54	F# 2	42	F# 1	Hi-Hat Closed	1								
B3		55	G 2	43	G 1	Floor Tom H									
C4	C#4	56	G# 2	44	G# 1	Hi-Hat Pedal	1								
D4	D#4	57	A 2	45	A 1	Low Tom									
E4		58	A# 2	46	A# 1	Hi-Hat Open	1								
F4	F#4	59	B 2	47	B 1	Mid Tom L									
G4	G#4	60	C 3	48	C 2	Mid Tom H									
A4	A#4	61	C# 3	49	C# 2	Crash Cymbal 1									
B4		62	D 3	50	D 2	High Tom									
C5	C#5	63	D# 3	51	D# 2	Ride Cymbal 1									
D5	D#5	64	E 3	52	E 2	Chinese Cymbal									
E5		65	F 3	53	F 2	Ride Cymbal Cup									
F5	F#5	66	F# 3	54	F# 2	Tambourine									
G5	G#5	67	G 3	55	G 2	Splash Cymbal									
A5	A#5	68	G# 3	56	G# 2	Cowbell									
B5		69	A 3	57	A 2	Crash Cymbal 2									
C6	C#6	70	A# 3	58	A# 2	Vibraslap									
D6	D#6	71	B 3	59	B 2	Ride Cymbal 2									
E6		72	C 4	60	C 3	Bongo H									
F6	F#6	73	C# 4	61	C# 3	Bongo L									
G6		74	D 4	62	D 3	Conga H Mute									
		75	D# 4	63	D# 3	Conga H Open									
		76	E 4	64	E 3	Conga L									
		77	F 4	65	F 3	Timbale H									
		78	F# 4	66	F# 3	Timbale L									
		79	G 4	67	G 3	Agogo H									
		80	G# 4	68	G# 3	Agogo L									
		81	A 4	69	A 3	Cabasa									
		82	A# 4	70	A# 3	Maracas									
		83	B 4	71	B 3	Samba Whistle H	O								
		84	C 5	72	C 4	Samba Whistle L	O								
		85	C# 5	73	C# 4	Guiro Short									
		86	D 5	74	D 4	Guiro Long	O								
		87	D# 5	75	D# 4	Claves									
		88	E 5	76	E 4	Wood Block H									
		89	F 5	77	F 4	Wood Block L									
		90	F# 5	78	F# 4	Cuica Mute									
		91	G 5	79	G 4	Cuica Open									
		92	G# 5	80	G# 4	Triangle Mute	2								
		93	A 5	81	A 4	Triangle Open	2								
		94	A# 5	82	A# 4	Shaker									
		95	B 5	83	B 4	Jingle Bells									
		96	C 6	84	C 5	Bell Tree									
		97	C# 6	85	C# 5										
		98	D 6	86	D 5										
		99	D# 6	87	D# 5										
		100	E 6	88	E 5										
		101	F 6	89	F 5										
		102	F# 6	90	F# 5										
		103	G 6	91	G 5										

Performance List

● MM6

Bank	Performance	Pattern	Sync Start	Main Voice	Dual Voice	Split Voice	Split Point	Chord Fingering
1	1	RnB Ballad1 D,B	-	Power Grand	-	-	B2	Multi Finger
	2	RnB Ballad1 D,B	-	Sweetness	-	-	B2	Multi Finger
	3	RockPop D,B	-	Mega Steel Guitar	-	-	B2	Multi Finger
	4	ElektroPop1	-	Da Pad	-	-	B2	Multi Finger
	5	SouthernRap1	On	After 1984	-	-	B2	Multi Finger
	6	RootRock	On	Rock Percussive	-	Over The Top	B2	Multi Finger
	7	Underground	On	Dancy Hook	Light Comp	-	B2	Multi Finger
	8	WestcoastRap1D	-	Lo-Fi Looper	Knock Bass	Laser Beam	B2	Multi Finger
2	1	WestcoastRap2	On	Harpichord	-	-	B2	Multi Finger
	2	JazzyRnB D	On	Sweetness	-	Finger Bass	B2	Multi Finger
	3	RnB Ballad1	On	Cool! Galaxy EP	-	-	B2	Full Keyboard
	4	PowerRock	On	Cool! Blues Guitar	-	-	B2	Multi Finger
	5	Dancefloor	On	Simple Oct2	Dancy Hook	-	B2	Multi Finger
	6	Chillout	On	Inda Night	LFO Pad	-	B2	Multi Finger
	7	ClubSamba	On	Sweet! Flute	-	-	B2	Multi Finger
	8	TurkishDance D	-	Meow Pad	Arab.Kit	U.F.O. Takeoff	B2	Multi Finger
3	1	SouthernRap2	On	Spiccato	-	Big Comp	B2	Multi Finger
	2	RnB Pop1	On	Orchestra Strings	-	Wurli Amped	B2	Multi Finger
	3	RnB Ballad1 D,B	On	Classic Piano	Slow Strings	-	B2	Full Keyboard
	4	RockShuffle D,B	On	Cool! Blues Guitar	-	Rock Vibrato	B2	Multi Finger
	5	Minimal	On	Crying	Trance Seq 2	-	B2	Multi Finger
	6	Ambient	On	Glass Arp	Amb Pad	-	B2	Multi Finger
	7	TurkishPop	On	Kanoun	Wataryat	Live! Steel Guitar	B2	Multi Finger
	8	HipHopPop	-	Volcano	Booty Bass	U.F.O. Takeoff	B2	Multi Finger
4	1	EastcoastRap	On	Simple Oct1	Wah Clavi	-	B2	Multi Finger
	2	RnB Ballad2 D,B	On	GM Nylon Guitar	Mini Soft	Aggressive	B2	Multi Finger
	3	RockPop D,B	On	Single Dream	Amb Pad	Live! Steel Guitar	B2	Multi Finger
	4	RockPop	On	Vintage C	-	-	B2	Multi Finger
	5	RetroDisco	On	Spiccato	Spiccato	-	B2	Multi Finger
	6	AmbientRap	On	Dark Light	-	-	B2	Full Keyboard
	7	Garba	On	Zheng	Detuned Sitar	-	B2	Multi Finger
	8	Analog D	-	Haunted	Zen	-	B2	Multi Finger
5	1	HipHopPop	On	Touch Clavi	-	-	B2	Multi Finger
	2	RnB Chart1 D,B	On	Early 70's	Sweet! Flute	Wurli Tremolo	B2	Multi Finger
	3	FunkPopRock	On	Cool! Organ	-	CP 80	B2	Multi Finger
	4	FunkPopRock D,B	On	Mini Soft	-	Vintage Case	B2	Multi Finger
	5	ClubDance	On	Dancy Hook	-	W Phaser	B2	Multi Finger
	6	Analog	On	Sky Walk	-	Vapor	B2	Multi Finger
	7	LatinPop	On	Cool! Suitcase EP	-	Wurli Amped	B2	Multi Finger
	8	RnB Pop2 D,B	-	Footsteps	Phone Call	-	B2	Multi Finger
6	1	WestcoastRap1	On	Power Grand	Rebirth '70	Wurli Tremolo	B2	Multi Finger
	2	RnB Ballad2 D,B	On	Spiccato	Spiccato	Chord Seq 1	B2	Multi Finger
	3	RnB Pop2 D,B	On	Mega Clean Guitar	-	Ober Brass	B2	Full Keyboard
	4	HardRock D,B	On	Mega Overdrive Gt	-	-	B2	Multi Finger
	5	Dancefloor	On	Snap Seq	Snap Seq	-	B2	Multi Finger
	6	JazzGroove	On	Amb Piano	Mystery Sine	Chorus EP	B2	Multi Finger
	7	TablaBeats D,B	On	Clack Bell	Tron Flute	-	B2	Multi Finger
	8	ChartPop D	-	Indian Kit	Bonang	-	B2	Multi Finger
7	1	EastcoastRap D,B	On	Inda Night	Haunted	Slow LFO Pad	B2	Multi Finger
	2	FunkyJazz	On	Jazz Guitar	-	-	B2	Multi Finger
	3	OrientalPop	On	Oud 1	Mizmar	-	B2	Multi Finger
	4	PowerRock D,B	On	Power Grand	-	-	B2	Full Keyboard
	5	Underground D,B	On	Over The Top	Overdriven Guitar	Trance Bass	B2	Multi Finger
	6	AcidJazz D,B	On	Inda Night	-	Early 70's	B2	Multi Finger
	7	Reggae	On	Cool! Rotor Organ	-	Wurli Amped	B2	Multi Finger
	8	EastcoastRap	-	Analog T8 Kit	Bassoon	Folk Guitar	B2	Multi Finger
8	1	RnB Chart2	On	Soft RnB	Mini Soft	Aggressive	B2	Multi Finger
	2	RnB Chart1	On	Prog Lead	-	-	B2	Multi Finger
	3	AfricanDance D,B	On	Kawala	-	Compact	B2	Multi Finger
	4	ChartRock	On	Sforzando Brass	Sforzando Brass	Classic Piano	B2	Multi Finger
	5	FunkyHouse D	On	Vintage'74	-	Fat Sine Resonance	B2	Multi Finger
	6	Ambient D	On	Car Engine Ignition	Long Spit	Live! Orchestra	B2	Multi Finger
	7	TurkishDance D,B	On	Jing Hu	Thai Bells	-	B2	Multi Finger
	8	Underground D	-	Meow Pad	-	-	B2	Multi Finger

Bank	Performance	Genre
2-8	1	HipHop
	2	R&B/Jazz
	3	Pop
	4	Rock

Bank	Performance	Genre
2-8	5	Dance
	6	Ambient
	7	World
	8	SE

● MM8

Bank	Performance	Pattern	Sync Start	Main Voice	Dual Voice	Split Voice	Split Point	Chord Fingering
1	1	RnB Ballad1 D,B	-	Power Grand	-	-	B2	Multi Finger
	2	FunkPopRock D,B	-	Sweetness	-	-	B2	Multi Finger
	3	FunkPopRock D,B	-	Touch Clavi	Super Clavi	-	B2	Multi Finger
	4	PowerRock D,B	-	Progressy	Cool! Rotor Organ	-	B2	Multi Finger
	5	RockPop D,B	-	Mega Steel Guitar	-	-	B2	Multi Finger
	6	Ambient D,B	-	Live! Allegro	Spiccato	-	B2	Multi Finger
	7	PianoBallad D,B	-	Back Pad	Back Pad	Chorus Pad	B2	Multi Finger
	8	FunkPopRock D,B	-	Live! Pop Brass	Live! Pop Brass	Cool! Rotor Organ	B2	Multi Finger
2	1	RnB Ballad1 D,B	-	Power Grand	Mid Range	-	B2	Multi Finger
	2	JazzyRnB D,B	-	Cool! Suitcase EP	Analog	-	B2	Multi Finger
	3	RnB Ballad1 D,B	-	Sky Walk	Landscape	-	B2	Multi Finger
	4	Dancefloor D,B	-	Dancy Hook	Dancy Hook	-	B2	Multi Finger
	5	Ambient D,B	-	Haunted	Mid Range	-	B2	Multi Finger
	6	ChartRock D,B	-	GM Atmosphere	Neo Crystal	Mid Range	B2	Multi Finger
	7	AcidJazz D,B	-	Dynamic Mini	-	Noble Pad	B2	Multi Finger
	8	ElektroPop1 D,B	-	Trance Seq 2	Noble Pad	Dark Light	B2	Multi Finger
3	1	SouthernRap1	On	After 1984	-	-	B2	Multi Finger
	2	JazzyRnB D	On	Sweetness	-	Finger Bass	B2	Multi Finger
	3	RnB Ballad1	On	Cool! Galaxy EP	-	-	B2	Full Keyboard
	4	RootRock	On	Rock Percussive	-	Over The Top	B2	Multi Finger
	5	Underground	On	Dancy Hook	Light Comp	-	B2	Multi Finger
	6	Chillout	On	Inda Night	LFO Pad	-	B2	Multi Finger
	7	ClubSamba	On	Sweet! Flute	-	-	B2	Multi Finger
	8	WestcoastRap1D	-	Lo-Fi Looper	Knock Bass	Laser Beam	B2	Multi Finger
4	1	WestcoastRap2	On	Harpichord	-	-	B2	Multi Finger
	2	RnB Pop1	On	Orchestra Strings	-	Wurli Amped	B2	Multi Finger
	3	RnB Ballad1 D,B	On	Classic Piano	Slow Strings	-	B2	Full Keyboard
	4	PowerRock	On	Cool! Blues Guitar	-	-	B2	Multi Finger
	5	FunkyHouse D	On	Vintage'74	-	Fat Sine Resonance	B2	Multi Finger
	6	Ambient	On	Glass Arp	Amb Pad	-	B2	Multi Finger
	7	TurkishPop	On	Kanoun	Wataryat	Live! Steel Guitar	B2	Multi Finger
	8	EastcoastRap D,B	On	Inda Night	Haunted	Slow LFO Pad	B2	Multi Finger
5	1	SouthernRap2	On	Spiccato	-	Big Comp	B2	Multi Finger
	2	RnB Ballad2 D,B	On	GM Nylon Guitar	Mini Soft	Aggressive	B2	Multi Finger
	3	RockPop D,B	On	Single Dream	Amb Pad	Live! Steel Guitar	B2	Multi Finger
	4	RockShuffle D,B	On	Cool! Blues Guitar	-	Rock Vibrato	B2	Multi Finger
	5	RetroDisco	On	Spiccato	Spiccato	-	B2	Multi Finger
	6	AmbientRap	On	Dark Light	-	-	B2	Full Keyboard
	7	LatinPop	On	Cool! Suitcase EP	-	Wurli Amped	B2	Multi Finger
	8	Garba	On	Zheng	Detuned Sitar	-	B2	Multi Finger
6	1	EastcoastRap	On	Simple Oct1	Wah Clavi	-	B2	Multi Finger
	2	RnB Chart1 D,B	On	Early 70's	Sweet! Flute	Wurli Tremolo	B2	Multi Finger
	3	FunkPopRock	On	Cool! Organ	-	CP 80	B2	Multi Finger
	4	RockPop	On	Vintage C	-	-	B2	Multi Finger
	5	ClubDance	On	Dancy Hook	-	W Phaser	B2	Multi Finger
	6	Analog	On	Sky Walk	-	Vapor	B2	Multi Finger
	7	TablaBeats D,B	On	Clack Bell	Tron Flute	-	B2	Multi Finger
	8	OrientalPop	On	Oud 1	Mizmar	-	B2	Multi Finger
7	1	HipHopPop	On	Touch Clavi	-	-	B2	Multi Finger
	2	RnB Ballad2 D,B	On	Spiccato	Spiccato	Chord Seq 1	B2	Multi Finger
	3	PowerRock D,B	On	Power Grand	-	Over The Top	B2	Full Keyboard
	4	FunkPopRock D,B	On	Mini Soft	-	Vintage Case	B2	Multi Finger
	5	Dancefloor	On	Snap Seq	Snap Seq	-	B2	Multi Finger
	6	JazzGroove	On	Amb Piano	Mystery Sine	Chorus EP	B2	Multi Finger
	7	Reggae	On	Cool! Rotor Organ	-	Wurli Amped	B2	Multi Finger
	8	FunkyJazz	On	Jazz Guitar	-	-	B2	Multi Finger
8	1	WestcoastRap1	On	Power Grand	Rebirth '70	Wurli Tremolo	B2	Multi Finger
	2	RnB Chart2	On	Soft RnB	Mini Soft	Aggressive	B2	Multi Finger
	3	ChartRock	On	Sforzando Brass	Sforzando Brass	Classic Piano	B2	Multi Finger
	4	HardRock D,B	On	Mega Overdrive Gt	-	-	B2	Multi Finger
	5	Underground D,B	On	Over The Top	Overdriven Guitar	Trance Bass	B2	Multi Finger
	6	AcidJazz D,B	On	Inda Night	-	Early 70's	B2	Multi Finger
	7	TurkishDance D,B	On	Jing Hu	Thai Bells	-	B2	Multi Finger
	8	AfricanDance D,B	On	Kawala	-	Compact	B2	Multi Finger

Bank	Performance	Genre
3-8	1	HipHop
	2	R&B/Jazz
	3	Pop
	4	Rock

Bank	Performance	Genre
3-8	5	Dance
	6	Ambient
	7	World
	8	Mixed

Pattern List

Pattern No.	Pattern Name
HipHop	
1	SouthernRap1
2	SouthernRap2
3	EastcoastRap
4	WestcoastRap1
5	WestcoastRap2
6	AmbientRap
7	HipHopPop
R&B	
8	RnB Chart1
9	RnB Chart2
10	RnB Ballad1
11	RnB Ballad2
12	RnB Soul
13	RnB Pop1
14	RnB Pop2
Pop and Rock	
15	ChartPop
16	RockPop
17	FunkPopRock
18	ChartRock
19	PowerRock
20	PianoBallad
21	BluesRock
22	RootRock
23	HardRock
24	RockShuffle
Dance/Ambient	
25	ElektroPop1
26	ElektroPop2
27	Techno
28	Underground
29	Minimal
30	Dancefloor
31	ElektroDisco
32	FunkyHouse
33	ClubDance
34	Garage
35	RetroDisco
36	Ambient
37	Chillout
38	Experimental
39	Analog
Jazz	
40	FunkyJazz
41	AcidJazz
42	JazzyRnB
43	JazzGroove
44	JazzRemixed
45	LatinJazz
World	
46	TurkishPop
47	TurkishDance
48	OrientalPop
49	AfricanDance
50	LatinPop
51	ClubSamba
52	Dancehall 1
53	Dancehall 2
54	Reggae
55	TablaBeats
56	Garba

Pattern No.	Pattern Name
HipHop D,B	
57	SouthernRap1D,B
58	SouthernRap2D,B
59	EastcoastRap D,B
60	WestcoastRap1D,B
61	WestcoastRap2D,B
62	AmbientRapD,B
63	HipHopPopD,B
R&B D,B	
64	RnB Chart1D,B
65	RnB Chart2 D,B
66	RnB Ballad1 D,B
67	RnB Ballad2 D,B
68	RnB Soul D,B
69	RnB Pop1 D,B
70	RnB Pop2 D,B
Pop and Rock D,B	
71	ChartPop D,B
72	RockPop D,B
73	FunkPopRock D,B
74	ChartRock D,B
75	PowerRock D,B
76	PianoBallad D,B
77	BluesRock D,B
78	RootRock D,B
79	HardRock D,B
80	RockShuffle D,B
Dance/Ambient D,B	
81	ElektroPop1 D,B
82	ElektroPop2 D,B
83	Techno D,B
84	Underground D,B
85	Minimal D,B
86	Dancefloor D,B
87	ElektroDisco D,B
88	FunkyHouse D,B
89	ClubDance D,B
90	Garage D,B
91	RetroDisco D,B
92	Ambient D,B
93	Chillout D,B
94	Experimental D,B
95	Analog D,B
Jazz D,B	
96	FunkyJazz D,B
97	AcidJazz D,B
98	JazzyRnB D,B
99	JazzGroove D,B
100	JazzRemixed D,B
101	LatinJazz D,B
World D,B	
102	TurkishPop D,B
103	TurkishDance D,B
104	OrientalPop D,B
105	AfricanDance D,B
106	LatinPop D,B
107	ClubSamba D,B
108	Dancehall 1 D,B
109	Dancehall 2 D,B
110	Reggae D,B
111	TablaBeats D,B
112	Garba D,B

Pattern No.	Pattern Name
HipHop D	
113	SouthernRap1D
114	SouthernRap2 D
115	EastcoastRap D
116	WestcoastRap1D
117	WestcoastRap2D
118	AmbientRap D
119	HipHopPop D
R&B D	
120	RnB Chart1D
121	RnB Chart2 D
122	RnB Ballad1 D
123	RnB Ballad2 D
124	RnB Soul D
125	RnB Pop1 D
126	RnB Pop2 D
Pop and Rock D	
127	ChartPop D
128	RockPop D
129	FunkPopRock D
130	ChartRock D
131	PowerRock D
132	PianoBallad D
133	BluesRock D
134	RootRock D
135	HardRock D
136	RockShuffle D
Dance/Ambient D	
137	ElektroPop1 D
138	ElektroPop2 D
139	Techno D
140	Underground D
141	Minimal D
142	Dancefloor D
143	ElektroDisco D
144	FunkyHouse D
145	ClubDance D
146	Garage D
147	RetroDisco D
148	Ambient D
149	Chillout D
150	Experimental D
151	Analog D
Jazz D	
152	FunkyJazz D
153	AcidJazz D
154	JazzyRnB D
155	JazzGroove D
156	JazzRemixed D
157	LatinJazz D
World D	
158	TurkishPop D
159	TurkishDance D
160	OrientalPop D
161	AfricanDance D
162	LatinPop D
163	ClubSamba D
164	Dancehall 1 D
165	Dancehall 2 D
166	Reggae D
167	TablaBeats D
168	Garba D

NOTE

• Patterns 57–112 play on the drum and bass parts from patterns 1–56, while patterns 113–168 play only the drum parts. "D" in a pattern name means "Drums," and "B" means "Bass."

Master EQ List

No.	Type	Description
1	Flat	Flat frequency response.
2	Attack	This setting emphasis attack for a crisp sound.
3	Hard	The bass is boosted for extra punch.
4	Retro	The reproduction range is reduced to produce an AM radio type sound.
5	High Pass	The low and mid frequencies are reduced so that the highs are prominent.

Effect Type List

● Reverb Types

No.	Type	Description	MSB	LSB
1	HALL1	Reverb simulating the acoustics of a hall.	1	0
2	HALL2		1	16
3	HALL3		1	17
4	HALL4		1	18
5	HALL5		1	1
6	HALL M		1	6
7	HALL L		1	7
8	ROOM1	Reverb simulating the acoustics of a room	2	16
9	ROOM2		2	17
10	ROOM3		2	18
11	ROOM4		2	19
12	ROOM5		2	0
13	ROOM6		2	1
14	ROOM7		2	2
15	ROOM S		2	5
16	ROOM M		2	6
17	ROOM L	2	7	
18	STAGE1	Reverb suitable for a solo instrument.	3	16
19	STAGE2		3	17
20	STAGE3		3	0
21	STAGE4		3	1
22	PLATE1	Reverb simulating a plate reverb unit.	4	16
23	PLATE2		4	17
24	PLATE3		4	0
25	GM PLATE		4	7
26	NO EFFECT	No effect.	0	0

● Chorus Types

No.	Type	Description	MSB	LSB
1	CHORUS1	Conventional chorus program with rich, warm chorusing.	66	17
2	CHORUS2		66	8
3	CHORUS3		66	16
4	CHORUS4		66	1
5	CHORUS5		65	2
6	CHORUS6		65	0
7	CHORUS7		65	1
8	CHORUS8		65	8
9	GM CHORUS1		65	3
10	GM CHORUS2		65	4
11	GM CHORUS3		65	5
12	GM CHORUS4		65	6
13	FB CHORUS		65	7
14	CELESTE1	A 3-phase LFO adds modulation and spaciousness to the sound.	66	0
15	CELESTE2		66	2
16	FLANGER1	Creates a sound reminiscent of a jet airplane.	67	8
17	FLANGER2		67	16
18	FLANGER3		67	17
19	FLANGER4		67	1
20	FLANGER5		67	0
21	GM FLANGER		67	7
22	SYMPHONIC1	Adds more stages to the modulation of Celeste.	68	16
23	SYMPHONIC2		68	0
24	PHASER1	Cyclically modulates the phase to add modulation to the sound.	72	0
25	PHASER2		72	8
26	EP PHASER1		72	17
27	EP PHASER2		72	18
28	EP PHASER3		72	16
29	ENS DETUNE	Chorus effect without modulation, created by adding a slightly pitch-shifted sound.	87	0
30	ROTARY SP5	Simulates a rotary speaker.	66	18
31	NO EFFECT	No effect.	0	0

● DSP Types

No.	Type	Description	MSB	LSB
1	HALL1	Reverb simulating the acoustics of a hall.	1	0
2	HALL2		1	16
3	HALL3		1	17
4	HALL4		1	18
5	HALL5		1	1
6	HALL M		1	6
7	HALL L		1	7
8	ROOM1	Reverb simulating the acoustics of a room.	2	16
9	ROOM2		2	17
10	ROOM3		2	18
11	ROOM4		2	19
12	ROOM5		2	0
13	ROOM6		2	1
14	ROOM7		2	2
15	ROOM S		2	5
16	ROOM M		2	6
17	ROOM L		2	7
18	STAGE1	Reverb suitable for a solo instrument.	3	16
19	STAGE2		3	17
20	STAGE3		3	0
21	STAGE4		3	1
22	PLATE1	Reverb simulating a plate reverb unit.	4	16
23	PLATE2		4	17
24	PLATE3		4	0
25	GM PLATE		4	7
26	CHORUS1	Conventional chorus program with rich, warm chorusing.	66	17
27	CHORUS2		66	8
28	CHORUS3		66	16
29	CHORUS4		66	1
30	CHORUS5		65	2
31	CHORUS6		65	0
32	CHORUS7		65	1
33	CHORUS8		65	8
34	GM CHORUS1		65	3
35	GM CHORUS2		65	4
36	GM CHORUS3		65	5
37	GM CHORUS4		65	6
38	FB CHORUS		65	7
39	CELESTE1	A 3-phase LFO adds modulation and spaciousness to the sound.	66	0
40	CELESTE2		66	2
41	SYMPHONIC1	Adds more stages to the modulation of Celeste.	68	16
42	SYMPHONIC2		68	0
43	ENS DETUNE	Chorus effect without modulation, created by adding a slightly pitch-shifted sound.	87	0
44	KARAOKE1	Echo for karaoke.	20	0
45	KARAOKE2		20	1
46	KARAOKE3		20	2
47	ER1	This effect isolates only the early reflection components of the reverb.	9	0
48	ER2		9	1
49	GATE REVERB	Simulation of gated reverb.	10	0
50	REVERS GATE	Simulation of gated reverb played back in reverse.	11	0
51	EQ DISCO	Equalizer effect that boosts both high and low frequencies, as is typical in most disco music.	76	16
52	EQ TEL	Equalizer effect that cuts both high and low frequencies, to simulate the sound heard through a telephone receiver.	76	17
53	2BAND EQ	A stereo EQ with adjustable LOW and HIGH. Ideal for drum Parts.	77	0
54	3BAND EQ		76	0
55	3BAND EQ2		76	19
56	HM ENHANCE1	Adds new harmonics to the input signal to make the sound stand out.	81	16
57	HM ENHANCE2		81	0
58	ST 3BAND EQ	An EQ which allows equalization of low, mid and high bands.	76	18
59	ST 3BAND EQ2		76	20
60	FLANGER1		67	8
61	FLANGER2	Creates a sound reminiscent of a jet airplane.	67	16
62	FLANGER3		67	17
63	FLANGER4		67	1
64	FLANGER5		67	0
65	GM FLANGER		67	7
66	DYN FLANGER		Dynamically controlled flanger.	110
67	DELAY LCR1	Produces three delayed sounds: L, R and C (center).	5	16
68	DELAY LCR2		5	0
69	DELAY LR	Produces two delayed sounds: L and R. Two feedback delays are provided.	6	0
70	ECHO	Two delayed sounds (L and R), and independent feedback delays for L and R.	7	0
71	CROSS DELAY	The feedback of the two delayed sounds is crossed.	8	0
72	DIST HEAVY	Heavy distortion.	73	0

Effect Type List

No.	Type	Description	MSB	LSB
73	ST DIST	Stereo distortion.	73	8
74	COMP+DIST1	Since a Compressor is included in the first stage, steady distortion can be produced regardless of changes in input level.	73	16
75	COMP+DIST2		73	1
76	OVERDRIVE	Adds mild distortion to the sound.	74	0
77	OVERDRIVE2		74	9
78	ST OD	Stereo Overdrive.	74	8
79	DIST HARD	Hard-edge distortion.	75	16
80	DIST HARD2		75	22
81	DIST HARD3		75	25
82	DIST SOFT		75	17
83	DIST SOFT2	Soft, warm distortion.	75	23
84	DIST SOFT3		75	26
85	ST DIST HARD	Hard-edge stereo distortion.	75	18
86	ST DIST SOFT	Soft, warm soft distortion.	75	19
87	V_DIST HARD	Distortion which simulates vintage tube and fuzz sounds.	98	0
88	V_DIST SOFT		98	2
89	AMP SIM1	A simulation of a guitar amp.	75	0
90	AMP SIM2		75	1
91	ST AMP1		75	20
92	ST AMP2		75	21
93	ST AMP3		75	8
94	ST AMP4		75	24
95	ST AMP5	75	27	
96	DST+DELAY1	Distortion and Delay are connected in series.	95	16
97	DST+DELAY2		95	0
98	OD+DELAY1	Overdrive and Delay are connected in series.	95	17
99	OD+DELAY2		95	1
100	CMP+DST+DLY1	Compressor, Distortion and Delay are connected in series.	96	16
101	CMP+DST+DLY2		96	0
102	CMP+OD+DLY1	Compressor, Overdrive and Delay are connected in series.	96	17
103	CMP+OD+DLY2		96	1
104	V_DIST H+DLY	V Distortion and Delay are connected in series.	98	1
105	V_DIST S+DLY		98	3
106	V_HVY+DLY_A	V Distortion produces the heavy distortion of a large guitar amp, in series with a long delay effect.	98	16
107	V_HVY+DLY_A-	V Distortion produces the heavy distortion of a large guitar amp, in series with a long delay effect. This effect is somewhat softer than the preceding effect.	98	17
108	V_HVY+DLY_A+	V Distortion produces the heavy distortion of a large guitar amp, in series with a long delay effect. This effect is somewhat stronger than the V_HVY+DLY_A effect.	98	18
109	V_HVY+DLY_B	V Distortion produces the heavy distortion of a mid-size guitar amp, in series with a short delay effect.	98	19
110	V_HVY+DLY_B-	V Distortion produces the heavy distortion of a mid-size guitar amp, in series with a short delay effect. This effect is somewhat softer than the preceding effect.	98	20
111	V_HVY+DLY_B+	V Distortion produces the heavy distortion of a mid-size guitar amp, in series with a short delay effect. This effect is somewhat stronger than the V_HVY+DLY_B effect.	98	21
112	MBAND COMP	Multi-band compressor that allows you to adjust the compression effect for individual frequency bands.	105	0
113	COMPRESSOR	Holds down the output level when a specified input level is exceeded. A sense of attack can also be added to the sound.	83	0
114	NOISE GATE	Gates the input when the input signal falls below a specified level.	84	0
115	VCE CANCEL	Attenuates the vocal part of a CD or other source.	85	0
116	AMBIENCE	Blurs the stereo positioning of the sound to add spatial width.	88	0
117	TALKING MOD	Adds a vowel sound to the input signal.	93	0
118	LO-FI	Degrades the audio quality of the input signal.	94	0
119	DYN FILTER	Dynamically controlled filter.	109	0
120	ISOLATOR	Controls the level of a specified frequency band of the input signal.	115	0
121	PHASER1	Cyclically modulates the phase to add modulation to the sound.	72	0
122	PHASER2		72	8
123	EP PHASER1		72	17
124	EP PHASER2		72	18
125	EP PHASER3		72	16
126	DYN PHASER		111	0
127	PITCH CHG1		80	16
128	PITCH CHG2	Changes the pitch of the input signal.	80	0
129	PITCH CHG3		80	1

No.	Type	Description	MSB	LSB
130	ROTARY SP1		69	16
131	ROTARY SP2		71	17
132	ROTARY SP3		71	18
133	ROTARY SP4		70	17
134	ROTARY SP5		66	18
135	ROTARY SP6		69	0
136	ROTARY SP7		71	22
137	ROTARY SP8		69	17
138	ROTARY SP9	Simulates a rotary speaker.	69	18
139	ROTARY SP10		71	23
140	ROTARY SP11		71	24
141	ROTARY SP12		70	20
142	ROTARY SP13		66	19
143	ROTARY SP14		69	19
144	ROTARY SP15		69	20
145	ROTARY SP16		71	25
146	2WAY ROT SP		86	0
147	DST+ROT SP	Distortion and rotary speaker connected in series.	69	1
148	DST+2ROT SP	Distortion and 2-way rotary speaker connected in series.	86	1
149	OD+ROT SP	Overdrive and rotary speaker connected in series.	69	2
150	OD+2ROT SP	Overdrive and 2-way rotary speaker connected in series.	86	2
151	AMP+ROT SP	Amp simulator and rotary speaker connected in series.	69	3
152	AMP+2ROT SP		86	3
153	AMP+2ROT SP2	Amp simulator and 2-way rotary speaker connected in series.	86	16
154	AMP+2ROT SP3		86	17
155	DUAL ROT SP1	Rotary speaker simulation.	99	0
156	DUAL ROT SP2		99	1
157	AUTO PAN1	Several panning effects that automatically shift the sound position (left, right, front, back).	71	16
158	AUTO PAN2		71	0
159	EP AUTOPAN		71	21
160	EP AUTOPAN2		71	26
161	AUTO PAN3		71	1
162	TREMOLO1	Rich Tremolo effect with both volume and pitch modulation.	70	16
163	TREMOLO2		71	19
164	TREMOLO3		70	0
165	EP TREMOLO		70	18
166	GT TREMOLO1		71	20
167	GT TREMOLO2		70	19
168	VIBE VIBRATE	Vibraphone effect.	119	0
169	AUTO WAH1	Cyclically modulates the center frequency of a wah filter.	78	16
170	AUTO WAH2		78	0
171	AT WAH+DST1	The output of an Auto Wah can be distorted by Distortion.	78	17
172	AT WAH+DST2		78	1
173	AT WAH+OD1	The output of an Auto Wah can be distorted by Overdrive.	78	18
174	AT WAH+OD2		78	2
175	TOUCH WAH1	Changes the center frequency of a wah filter according to the input level.	82	0
176	TOUCH WAH2		82	8
177	TOUCH WAH3		82	20
178	TC WAH+DST1	The output of an Touch Wah can be distorted by Distortion.	82	16
179	TC WAH+DST2		82	1
180	TC WAH+OD1	The output of an Touch Wah can be distorted by Overdrive.	82	17
181	TC WAH+OD2		82	2
182	CLAVI TC WAH	Clavinet Touch Wah.	82	18
183	CLAVI TC WAH2		82	21
184	EP TC WAH	EP Touch Wah	82	19
185	EP TC WAH2		82	22
186	WH+DST+DLY1	Wah, Distortion and Delay are connected in series.	97	16
187	WH+DST+DLY2		97	0
188	WH+OD+DLY1	Wah, Overdrive and Delay are connected in series.	97	17
189	WH+OD+DLY2		97	1
190	NO EFFECT	No effect.	0	0

Arpeggio Type List

No.	Arpeggio Type	Length	Tempo	Time Sig.	Voice Type
Seq					
1	UpOct1	1	120	4 / 4	Synth Lead
2	UpOct2	1	120	4 / 4	Synth Lead
3	UpOct4	1	120	4 / 4	Synth Lead
4	DownOct1	1	120	4 / 4	Synth Lead
5	DownOct2	1	120	4 / 4	Synth Lead
6	DownOct4	1	120	4 / 4	Synth Lead
7	U/DAOct1	1	120	4 / 4	Synth Lead
8	U/DAOct2	1	120	4 / 4	Synth Lead
9	U/DAOct4	1	120	4 / 4	Synth Lead
10	U/DBOct1	1	120	4 / 4	Synth Lead
11	U/DBOct2	1	120	4 / 4	Synth Lead
12	U/DBOct4	1	120	4 / 4	Synth Lead
13	RndmOct1	1	120	4 / 4	Synth Lead
14	RndmOct2	1	120	4 / 4	Synth Lead
15	RndmOct4	1	120	4 / 4	Synth Lead
16	Basic	1	130	4 / 4	Synth Lead
17	Melody1	1	70	4 / 4	Synth Lead
18	Melody2	1	70	4 / 4	Synth Lead
19	FifthSQ1	1	130	4 / 4	Synth Lead
20	FifthSQ2	1	130	4 / 4	Synth Lead
21	Electr1	1	130	4 / 4	Synth Lead
22	Electr2	1	130	4 / 4	Synth Lead
23	Electr3	1	130	4 / 4	Synth Lead
24	Electr4	1	130	4 / 4	Synth Lead
25	SynTrnce	1	130	4 / 4	Synth Lead
26	Simple	1	130	4 / 4	Synth Lead
27	OctSeq	1	130	4 / 4	Synth Lead
28	SynPhrs	2	145	4 / 4	Synth Lead
29	Random	1	90	4 / 4	Synth Lead
30	Compu Bs	1	130	4 / 4	Synth Lead
31	SynArp1	1	130	4 / 4	Synth Lead
32	SynArp2	1	130	4 / 4	Synth Lead
33	SynArp3	1	130	4 / 4	Synth Lead
34	SynArp4	1	138	4 / 4	Synth Lead
35	Techno	2	120	4 / 4	Synth Lead
36	SyncEcho	2	130	4 / 4	Synth Lead
37	PulsLine	2	120	4 / 4	Synth Lead
38	Doves	1	150	4 / 4	Synth Lead
39	Chodal	2	150	4 / 4	Synth Lead
40	Waggle	1	140	4 / 4	Synth Lead
41	SuperArp	2	120	4 / 4	Synth Lead
42	AcidLine	1	120	4 / 4	Synth Lead
43	TekEcho	2	120	4 / 4	Synth Lead
44	VelGroov	1	134	4 / 4	Synth Lead
45	MuteLine	1	134	4 / 4	Synth Lead
46	PolyArp	1	120	4 / 4	Synth Lead
47	Trance1	1	140	4 / 4	Synth Lead
48	Trance2	1	140	4 / 4	Synth Lead
49	Dream	1	136	4 / 4	Synth Lead
Chord Seq					
50	SynChord	1	130	4 / 4	Synth Lead
51	Syncopa	2	120	4 / 4	Synth Lead
52	Hybrid1	1	130	4 / 4	Synth Lead
53	Hybrid2	1	106	4 / 4	Synth Lead
54	TrnceChd	2	145	4 / 4	Synth Lead
55	TrnceRtm	4	140	4 / 4	Synth Lead
56	BscChd1	2	130	4 / 4	Synth Lead
57	BscChd2	1	130	4 / 4	Synth Lead
Ap/Kb					
58	Pf70sRk1	2	130	4 / 4	A.Piano/E.Piano
59	Pf70sRk2	4	130	4 / 4	A.Piano/E.Piano
60	Pf Arp1	2	100	4 / 4	A.Piano/E.Piano
61	Pf Arp2	2	70	4 / 4	A.Piano/E.Piano
62	Pf Arp3	2	130	4 / 4	A.Piano/E.Piano
63	Pf Arp4	1	116	4 / 4	A.Piano/E.Piano

No.	Arpeggio Type	Length	Tempo	Time Sig.	Voice Type
64	Pf Arp5	1	82	4 / 4	A.Piano/E.Piano
65	Pf Arp6	2	130	4 / 4	A.Piano/E.Piano
66	Pf Arp7	2	130	4 / 4	A.Piano/E.Piano
67	Pf Arp8	1	74	4 / 4	A.Piano/E.Piano
68	Pf Club	1	96	4 / 4	A.Piano/E.Piano
69	PfHouse	2	130	4 / 4	A.Piano/E.Piano
70	PfLatin1	2	138	4 / 4	A.Piano/E.Piano
71	PfLatin2	2	120	4 / 4	A.Piano/E.Piano
72	PfSalsa	1	123	4 / 4	A.Piano/E.Piano
73	PfMontno	2	100	4 / 4	A.Piano/E.Piano
74	EpSwing	1	101	4 / 4	A.Piano/E.Piano
75	Ep Slow	1	74	4 / 4	A.Piano/E.Piano
76	EpAnlgPp	2	93	4 / 4	A.Piano/E.Piano
77	EpChdUp	1	108	4 / 4	A.Piano/E.Piano
78	Clavi1	1	120	4 / 4	Clavi
79	Clavi2	1	110	4 / 4	Clavi
80	Clavi3	1	124	4 / 4	Clavi
81	EpReggae	2	92	4 / 4	Clavi
82	EpHipHop	2	105	4 / 4	Harpichord
83	EpNewGos	1	90	4 / 4	E.Piano
84	Ep6/8R&B	2	61	4 / 4	E.Piano
85	EpClubHs	2	128	4 / 4	E.Piano
Organ					
86	OrgHouse	1	130	4 / 4	Organ
87	OrgLatin	1	110	4 / 4	Organ
88	OrgRegge	1	92	4 / 4	Organ
Guitar					
89	GtStrum1	2	120	4 / 4	Steel Guitar
90	GtStrum2	2	120	4 / 4	Steel Guitar
91	GtStrum3	2	120	4 / 4	Steel Guitar
92	GtChord1	1	120	4 / 4	Clean Guitar
93	GtChord2	1	100	4 / 4	Clean Guitar
94	GtClean1	2	120	4 / 4	Clean Guitar
95	GtClean2	2	120	4 / 4	Clean Guitar
96	GtFunky1	1	120	4 / 4	Clean Guitar
97	GtFunky2	2	105	4 / 4	Clean Guitar
98	Gt Pop	1	90	4 / 4	Classical Guitar
99	Gt Slow	1	74	4 / 4	Steel Guitar
100	GtFingr1	2	120	4 / 4	Steel Guitar
101	GtFingr2	2	120	4 / 4	Steel Guitar
102	GtFingr3	2	120	4 / 4	Steel Guitar
103	GtFingr4	3	120	4 / 4	Steel Guitar
104	GtXovr1	2	100	4 / 4	Overdrive Gt/ Distortion Gt
105	GtXovr2	2	100	4 / 4	Overdrive Gt/ Distortion Gt
106	GtXovr3	2	100	4 / 4	Overdrive Gt/ Distortion Gt
107	GtHipHop	2	94	4 / 4	Muted Guitar
108	Gt Latin	2	120	4 / 4	Classical Guitar
109	GtSamba	1	120	4 / 4	Clean Guitar
110	GtSpnish	2	120	4 / 4	Classical Guitar
111	GtTurksh	2	105	4 / 4	Kanoun
112	MgStrum	4	120	4 / 4	Mega Steel Guitar
113	MgUnplg1	4	120	4 / 4	Mega Steel Guitar
114	MgUnplg2	2	120	4 / 4	Mega Steel Guitar
115	MgUnplg3	2	120	4 / 4	Mega Steel Guitar
116	MgUnplg4	2	120	4 / 4	Mega Steel Guitar
117	MgUnplg5	1	120	4 / 4	Mega Steel Guitar
118	MgFlkRck	2	120	4 / 4	Mega Steel Guitar
119	MgSttRck	2	120	4 / 4	Mega Steel Guitar
120	MgChlOut	2	79	4 / 4	Mega Steel Guitar
121	MgRtrPop	2	126	4 / 4	Mega Steel Guitar
122	MgSpnish	2	120	4 / 4	Mega Steel Guitar
123	MgClGt1	4	107	4 / 4	Mega Clean Guitar
124	MgClGt2	4	107	4 / 4	Mega Clean Guitar
125	MgClGt3	4	107	4 / 4	Mega Clean Guitar

No.	Arpeggio Type	Length	Tempo	Time Sig.	Voice Type
126	MgClGt4	4	107	4 / 4	Mega Clean Guitar
127	MgFunk1	2	120	4 / 4	Mega Clean Guitar
128	MgFunk2	1	120	4 / 4	Mega Clean Guitar
129	MgClHip	2	90	4 / 4	Mega Clean Guitar
130	MgAnlgPp	2	93	4 / 4	Mega Clean Guitar
131	MgOdGt1	4	120	4 / 4	Mega Overdrive Gt
132	MgOdGt2	4	120	4 / 4	Mega Overdrive Gt
133	MgOdGt3	4	120	4 / 4	Mega Overdrive Gt
134	MgOdGt4	4	120	4 / 4	Mega Overdrive Gt
135	MgOd70Rk	2	130	4 / 4	Mega Overdrive Gt
136	GtOvrTp1	2	120	4 / 4	Over TheTop
137	GtOvrTp2	4	120	4 / 4	Over TheTop
Bass					
138	BsFingr1	1	115	4 / 4	Finger Bass
139	BsFingr2	3	115	4 / 4	Finger Bass
140	BsKIFunk	1	96	4 / 4	Finger Bass
141	Bs Slap	3	120	4 / 4	Slap Bass
142	BsCmbJz	4	204	4 / 4	Acoustic Bass
143	BsGroove	2	120	4 / 4	Synth Bass
144	BsHipHp1	1	105	4 / 4	Synth Bass
145	BsHipHp2	2	94	4 / 4	Synth Bass
146	BsHipHp3	1	94	4 / 4	Synth Bass
147	BsSmooth	1	115	4 / 4	Synth Bass
148	BsNewGos	2	90	4 / 4	Synth Bass
149	Bs Acid	1	120	4 / 4	Synth Bass
150	BsTechno	1	138	4 / 4	Synth Bass
151	Bs Dream	1	136	4 / 4	Synth Bass
152	BsClubHs	1	128	4 / 4	Synth Bass
153	Bs Disco	2	110	4 / 4	Synth Bass
154	Bs Latin	4	138	4 / 4	Synth Bass
155	BsMontno	4	100	4 / 4	Finger Bass
156	BsReggae	1	92	4 / 4	Finger Bass
157	BsFunk1	2	120	4 / 4	Finger Bass
158	BsFunk2	4	120	4 / 4	Finger Bass
Strings					
159	StrBasic	1	101	4 / 4	Strings
160	Str R&B	1	90	4 / 4	Strings
161	StrTrksh	2	86	4 / 4	Strings
162	Pizzcato	1	120	4 / 4	Strings
Brass/Reed					
163	BrsFunk1	4	132	4 / 4	Brass
164	BrsFunk2	1	132	4 / 4	Brass
165	BrsSamba	2	120	4 / 4	Brass
166	Flutter	1	120	4 / 4	Reed
167	ReedSoul	4	120	4 / 4	Reed
168	ReedHpHp	2	105	4 / 4	Reed
Synth Lead					
169	SynDsco1	1	110	4 / 4	Synth Lead
170	SynDsco2	2	110	4 / 4	Synth Lead
CrPerc					
171	Prc Arp	2	110	4 / 4	CrPerc
172	PrcTrill	1	120	4 / 4	CrPerc
173	PrcDisco	2	110	4 / 4	CrPerc
Drum					
174	Dr Funk	4	107	4 / 4	Standard Kit
175	DrGospel	2	126	3 / 4	Standard Kit
176	DrCmbJz	4	204	4 / 4	Standard Kit
177	DrUnplug	1	120	4 / 4	Standard Kit
178	DrFngrPk	4	120	4 / 4	Standard Kit
179	DrGtrPop	1	90	4 / 4	Standard Kit
180	DrXovrRk	2	100	4 / 4	Standard Kit
181	DrHipHop	2	94	4 / 4	Break Kit
182	DrLoBeat	2	140	4 / 4	Break Kit
183	DrAnlgPp	2	93	4 / 4	Analog T8 Kit
184	DrEuroTk	2	140	4 / 4	DanceKit1
185	DrTrance	4	140	4 / 4	Analog T9 Kit

No.	Arpeggio Type	Length	Tempo	Time Sig.	Voice Type
186	DrHouse1	2	123	4 / 4	Analog T9 Kit
187	DrHouse2	2	130	4 / 4	Analog T9 Kit
188	DrClubHs	1	128	4 / 4	Analog T9 Kit
189	DrGroove	2	96	4 / 4	Hip Hop Kit
190	Dr Perc1	2	135	4 / 4	Standard Kit
191	Dr Perc2	1	100	4 / 4	Standard Kit
192	Dr Club	1	128	4 / 4	Standard Kit
193	DrSamba	4	120	4 / 4	Standard Kit
194	DrSalsa	2	123	4 / 4	Standard Kit
195	DrAfricn	2	122	4 / 4	Standard Kit
196	DrTambrn	2	123	4 / 4	Dance Kit1
197	Dr R&B	2	110	4 / 4	Standard Kit
198	DrFunky	4	130	4 / 4	Standard Kit
199	DrClHip	2	118	4 / 4	Standard Kit
200	Dr Latin	2	104	4 / 4	Standard Kit
201	DrArabic	2	100	4 / 4	Standard Kit
202	DrOryant	2	130	4 / 4	Arab. Kit
203	Dr Azeri	1	160	6 / 8	Arab. Kit
204	Dr 9/8	2	120	9 / 8	Arab. Kit
205	DrSaeidy	2	110	4 / 4	Arab. Kit
206	DrMksoum	1	130	4 / 4	Arab. Kit
207	DrKarach	2	120	4 / 4	Arab. Kit
208	DrIndia1	4	128	4 / 4	Indian Kit
209	DrIndia2	4	123	4 / 4	Indian Kit
210	Dr China	1	106	4 / 4	Chinese kit
211	DrMrngue	2	130	4 / 4	Afro Cuban Kit
212	DrMambo	1	104	4 / 4	Afro Cuban Kit
213	Dr70Dsco	2	120	4 / 4	Pop Latin Kit

MIDI Implementation Chart

YAMAHA [MUSIC SYNTHESIZER] Date : 1-FEB-2008
 Model MM6/MM8 MIDI Implementation Chart Version : 1.0

Function...	Transmitted	Recognized	Remarks
Basic Channel Default Changed	1 - 16 x	1 - 16 x	
Mode Default Messages Altered	3 x *****	3 x x	
Note Number : True voice	0 - 127 *****	0 - 127 0 - 127	
Velocity Note ON Note OFF	0 9nH, v=1-127 x 9nH, v=0	0 9nH, v=1-127 x	
After Touch Key's Ch's	x x	x x	
Pitch Bend	0	0 0-24 semi	
Control Change	0, 32 1, 7, 10, 11 6, 38 64 71 72 73 74 84, 96-97 91, 93, 94 100-101	0 0 0 0 0 0 0 0 x 0 0	Bank Select Data Entry Sustain Harmonic Content Release Time Attack Time Brightness Effect Depth RPN LSB, MSB

Prog Change : True #	o 0 - 127 *****	o 0 - 127
System Exclusive	o	o
: Song Pos.	x	x
: Song Sel.	x	x
: Tune	x	x
System : Clock	o	o
Real Time: Commands	o	o
Aux :All Sound OFF	x	o (120, 126, 127)
:Reset All Cntrls	x	o (121)
:Local ON/OFF	x	o (122)
:All Notes OFF	x	o (123-125)
Mes- :Active Sense	o	o
sages:Reset	x	x

*1 These Control Changes are not transmitted by the panel operation. However, they may be transmitted while performing Pattern or the Song.

Mode 1 : OMNI ON , POLY Mode 2 : OMNI ON , MONO o : Yes
 Mode 3 : OMNI OFF, POLY Mode 4 : OMNI OFF, MONO x : No

MIDI Data Format

NOTE:

- 1 By default (factory settings) the instrument ordinarily functions as a 16-channel multi-timbral tone generator, and incoming data does not affect the panel voices or panel settings. However, the MIDI messages listed below do affect the panel voices, auto accompaniment, and songs.
 - MIDI Master Tuning
 - System exclusive messages for changing the Reverb Type and Chorus Type.

- 2 Exclusive
 - <GM System ON> F0H, 7EH, 7FH, 09H, 01H, F7H
 - This message automatically restores all default settings for the instrument, with the exception of MIDI Master Tuning.

 - <MIDI Master Volume> F0H, 7FH, 7FH, 04H, 01H, ll, mm, F7H
 - This message allows the volume of all channels to be changed simultaneously (Universal System Exclusive).
 - The values of "mm" is used for MIDI Master Volume. (Values for "ll" are ignored.)

 - <MIDI Master Tuning> F0H, 43H, 1nH, 27H, 30H, 00H, 00H, mm, ll, cc, F7H
 - This message simultaneously changes the tuning value of all channels.
 - The values of "mm" and "ll" are used for MIDI Master Tuning.
 - The default value of "mm" and "ll" are 08H and 00H, respectively. Any values can be used for "n" and "cc".

 - <Reverb Type> F0H, 43H, 1nH, 4CH, 02H, 01H, 00H, mmH, llH, F7H
 - mm : Reverb Type MSB
 - ll : Reverb Type LSBRefer to the Effect Type List (page 100) for details.

 - <Chorus Type> F0H, 43H, 1nH, 4CH, 02H, 01H, 20H, mmH, llH, F7H
 - mm : Chorus Type MSB
 - ll : Chorus Type LSBRefer to the Effect Type List (page 100) for details.

 - <DSP Type> F0H, 43H, 1nH, 4CH, 02H, 01H, 40H, mmH, llH, F7H
 - mm : DSP Type MSB
 - ll : DSP Type LSBRefer to the Effect Type List (page 101) for details.

- 3 When the accompaniment is started, an FAH message is transmitted. When accompaniment is stopped, an FCH message is transmitted. When the clock is set to External, both FAH (accompaniment start) and FCH (accompaniment stop) are recognized.

- 4 Local ON/OFF
 - <Local ON> Bn, 7A, 7F
 - <Local OFF> Bn, 7A, 00Value for "n" is ignored.

Specifications

Keyboards	MM8	88 keys (Initial touch)
	MM6	61 keys (Initial touch)
Tone Generator block	Tone Generator	AWM2
	Polyphony	32 notes
	Multi Timbral Capacity	16 parts
	Wave	70MB(when converted to 16-bit linear format)
	Voice	Preset: 418 normal voices + 22 drum kits GM: 128 normal voices + 1 drum kit
	Performance	8 banks x 8
	Effect System	Reverb x 25 types, Chorus x 30 types, Variation x 189 types
	Master Equalizer	5 types
Sequencer block	Note Resolution	96 ppq (parts per quarter note)
	Tempo (BPM)	11–280
	Recording type	Real time replace
	Tracks	8 + 8 (Pattern track)
	Patterns	168 patterns (x 4 sections)
	Songs	Preset: 3 songs User: 5 songs USB: 400 songs maximum
	Arpeggio	Preset x 213 types
	Others	Controllers
Display		320 x 240 dot graphic LCD (backlit)
Connectors		OUTPUT L/MONO, R (standard phone jack), PHONES (standard stereo phone jack), FOOT CONTROLLER, SUSTAIN, MIDI IN/OUT, USB (TO HOST, TO DEVICE), DC INLET
Power Consumption		12W
Dimensions, Weight		MM8: 1,340(W) x 445(D) x 157(H)mm, 15.6kg MM6: 949(W) x 374(D) x 123(H)mm, 5.0kg
Accessories		AC Power Adaptor, Owner's Manual (this book), Supplied Disk (supplied DAW software)

* Specifications and descriptions in this owner's manual are for information purposes only. Yamaha Corp. reserves the right to change or modify products or specifications at any time without prior notice. Since specifications, equipment or options may not be the same in every locale, please check with your Yamaha dealer.

Index

- [◀◀] (Fast Reverse) button..... 12, 27
- [▶▶] (Fast Forward) button 12, 27
- [||] (Pause) button 12, 27
- [▶/■] (START/STOP) button 12

A

- Accessories..... 7
- [A]–[D] buttons 12
- [ARPEGGIO ON/OFF] button 13, 20
- Arpeggio Type 21, 65
- Arpeggio Type List 104
- Arpeggio Velocity 48, 65
- ATTACK..... 41
- [ATTACK] knob 12
- AUTO FILL IN 51
- [AUTO FILL IN] button 12
- Auto-accompaniment Range 23

B

- Backup..... 35
- Backup Clear 35
- Bank 59

C

- Cable clip 10, 13
- CATEGORY [DEC], [INC] buttons
..... 12, 37
- CATEGORY SEARCH buttons ... 13, 15
- Chord..... 25
- Chord Basic..... 54
- Chord Fingering 56, 65
- Chorus 43
- Chorus Type 43, 65
- Chorus Type List..... 100
- Computer..... 10
- Convert (SMF Format)..... 70
- CUTOFF 41
- [CUTOFF] knob..... 12

D

- DC IN jack 13
- [DEC/NO] button 12, 37
- Delete (USB Storage Device) 72
- Demo 14
- Demo Cancel 65
- Demonstration Song..... 14
- Dial 12, 37
- Display 12, 38
- Drum Kit 19
- Drum Kit List 90
- [DRUM/PERC/SE] button 19
- DSP 44
- DSP On/Off..... 65
- DSP Type 44, 65

- DSP Type List..... 101
- Dual..... 16
- [DUAL] button 13, 16
- Dual Voice 16
- Dual Voice Chorus Level 63
- Dual Voice Dry Level..... 63
- Dual Voice DSP Level..... 63
- Dual Voice Octave..... 63
- Dual Voice Pan 63
- Dual Voice Reverb Level 63
- Dual Voice Volume 63

E

- [EDIT] button 12, 62
- EDIT display..... 38
- Effect Type List 100
- Erase (Performance Memory)..... 61
- [EXECUTE] button 12, 68, 69
- [EXIT] button 12, 38
- External Clock 78, 79
- External Clock On/Off..... 65

F

- Fast Forward 27
- Fast Reverse 27
- Fill In..... 51
- [FINGER] button 12
- Foot Controller..... 41
- FOOT CONTROLLER jack..... 13, 41
- Footswitch..... 41
- Format (USB Storage Device)..... 68
- Full Keyboard 65

H

- Headphones..... 10

I

- [INC/YES] button..... 12, 37
- Initial Setup..... 65, 79
- Initialization 35

K

- Keyboard Out..... 65, 78, 79
- Knob..... 41

L

- LCD Contrast Control..... 11
- LCD CONTRAST knob 12
- Load 71
- Local 78, 79
- Local On/Off..... 65

M

- MAIN display..... 38, 39
- Main Section..... 51
- Main Voice 15
- Main Voice Chorus Level 63
- Main Voice Dry Level..... 63
- Main Voice DSP Level..... 63
- Main Voice Octave..... 63
- Main Voice Pan 63
- Main Voice Reverb Level 63
- Main Voice Volume 63
- Master EQ List 99
- Master EQ Type 48, 65
- [MASTER VOLUME] control..... 12, 14
- Measure Number 31
- [MENU] button 12, 67, 68
- Messages 83
- Metronome 45
- [METRONOME] button 12, 45
- Metronome Volume 46, 65
- MIDI..... 74
- MIDI Data Format..... 108
- MIDI Implementation Chart..... 106
- MIDI IN, OUT terminals..... 13, 73
- MIDI Setting..... 78
- [MODULATION] wheel..... 12
- Modulation wheel..... 40
- Mute..... 58

O

- Octave..... 50
- OCTAVE [UP], [DOWN] buttons
..... 13, 50
- OUTPUT R, L/MONO jacks..... 13, 73

P

- Pattern..... 22, 51
- [PATTERN] button 12, 14, 22
- Pattern File 69, 71
- Pattern List 98
- Pattern Out..... 65, 78, 79
- Pattern Volume..... 53, 65
- Pause..... 27
- PC Mode..... 65, 79
- PERFORMANCE BANK [DEC],
[INC] buttons 13, 59
- Performance List 96
- Performance Memory 59
- PERFORMANCE MEMORY [1]–[8]
buttons 13, 59
- Personal Computer 77
- PHONES jack..... 13
- Pitch Bend Range 65
- [PITCH BEND] wheel 12

Pitch Bend wheel..... 40
 [PRESET] button 12, 26
 Preset Song 28

R

[REC] button 12, 30
 Recording 29
 RELEASE 41
 [RELEASE] knob..... 12
 RESONANCE..... 41
 [RESONANCE] knob 12
 Reverb 42
 Reverb Type 42, 65
 Reverb Type List..... 100

S

Saving Data 69
 Section..... 51
 SMF (Standard MIDI File)..... 70
 Song..... 26
 [SONG] button 12, 14
 Song Clear 33
 Song Out..... 65, 78, 79
 Song Volume..... 57, 65
 Speaker 74
 Specifications 109
 [SPLIT] button 13, 17
 Split Point..... 52, 65
 Split Voice..... 17
 Split Voice Chorus Level 63
 Split Voice Dry Level 63
 Split Voice DSP Level 63
 Split Voice Octave 63
 Split Voice Pan..... 63
 Split Voice Reverb Level 63
 Split Voice Volume..... 63
 [STANDBY/ON] switch... 10, 11, 13, 14
 Start/Stop..... 37
 [START/STOP] button
 12, 14, 22, 27, 37
 Stop Accompaniment 53
 [STORE] button 13, 59
 Supplied DAW Software..... 80
 Supplied Disk 80
 Sustain 41
 SUSTAIN jack 13, 41
 Sync Start 23, 51
 [SYNC START] button..... 12, 23

T

Tap..... 47
 [TAP TEMPO] button..... 12, 47
 Tempo 47, 57
 TEMPO [+], [-] buttons..... 12, 57

Time Signature – Denominator..... 46, 65
 Time Signature – Numerator 65
 Touch Sensitivity 47, 65
 Track 29
 TRACK [1]–[8] buttons..... 13
 Track Clear 34
 Track Mute..... 29
 TRACK [PATTERN] button 13
 [TRACK SELECT/MUTE] button
 13, 58
 Transpose 49
 TRANSPOSE [+], [-] buttons 13, 49
 Troubleshooting 82
 Tuning 49, 65

U

[USB] button..... 12, 26
 USB Song 28
 USB Storage Device 66, 75
 USB TO DEVICE terminal 13, 73
 USB TO HOST terminal..... 13, 73
 USB-MIDI Driver..... 77
 [USER] button 12, 26, 30
 User Pattern..... 71
 User Song 28, 29
 [UTILITY] button..... 12, 64
 UTILITY display 38

V

Voice 15
 Voice List..... 84

Limited Warranty

90 DAYS LABOR

1 YEAR PARTS

Yamaha Corporation of America, hereafter referred to as Yamaha, warrants to the original consumer of a product included in the categories listed below, that the product will be free of defects in materials and/or workmanship for the periods indicated. This warranty is applicable to all models included in the following series of products:

MUSIC SYNTHESIZER MM6/MM8

If during the first 90 days that immediately follows the purchase date, your new Yamaha product covered by this warranty is found to have a defect in material and/or workmanship, Yamaha and/or its authorized representative will repair such defect without charge for parts or labor.

If parts should be required after this 90 day period but within the one year period that immediately follows the purchase date, Yamaha will, subject to the terms of this warranty, supply these parts without charge. However, charges for labor, and/or any miscellaneous expenses incurred are the consumers responsibility. Yamaha reserves the right to utilize reconditioned parts in repairing these products and/or to use reconditioned units as warranty replacements.

THIS WARRANTY IS THE ONLY EXPRESS WARRANTY WHICH YAMAHA MAKES IN CONNECTION WITH THESE PRODUCTS. ANY IMPLIED WARRANTY APPLICABLE TO THE PRODUCT, INCLUDING THE WARRANTY OF MERCHANT ABILITY IS LIMITED TO THE DURATION OF THE EXPRESS WARRANTY. YAMAHA EXCLUDES AND SHALL NOT BE LIABLE IN ANY EVENT FOR INCIDENTAL OR CONSEQUENTIAL DAMAGES.

Some states do not allow limitations that relate to implied warranties and/or the exclusion of incidental or consequential damages. Therefore, these limitations and exclusions may not apply to you.

This warranty gives you specific legal rights. You may also have other rights which vary from state to state.

CONSUMERS RESPONSIBILITIES

If warranty service should be required, it is necessary that the consumer assume certain responsibilities:

1. Contact the Customer Service Department of the retailer selling the product, or any retail outlet authorized by Yamaha to sell the product for assistance. You may also contact Yamaha directly at the address provided below.
2. Deliver the unit to be serviced under warranty to: the retailer selling the product, an authorized service center, or to Yamaha with an explanation of the problem. Please be prepared to provide proof purchase date (sales receipt, credit card copy, etc.) when requesting service and/or parts under warranty.
3. Shipping and/or insurance costs are the consumers responsibility.* Units shipped for service should be packed securely.

*Repaired units will be returned PREPAID if warranty service is required within the first 90 days.

IMPORTANT: Do NOT ship anything to ANY location without prior authorization. A Return Authorization (RA) will be issued that has a tracking number assigned that will expedite the servicing of your unit and provide a tracking system if needed.

4. Your owners manual contains important safety and operating instructions. It is your responsibility to be aware of the contents of this manual and to follow all safety precautions.

EXCLUSIONS

This warranty does not apply to units whose trade name, trademark, and/or ID numbers have been altered, defaced, exchanged removed, or to failures and/or damages that may occur as a result of:

1. Neglect, abuse, abnormal strain, modification or exposure to extremes in temperature or humidity.
2. Improper repair or maintenance by any person who is not a service representative of a retail outlet authorized by Yamaha to sell the product, an authorized service center, or an authorized service representative of Yamaha.
3. This warranty is applicable only to units sold by retailers authorized by Yamaha to sell these products in the U.S.A., the District of Columbia, and Puerto Rico. This warranty is not applicable in other possessions or territories of the U.S.A. or in any other country.

Please record the model and serial number of the product you have purchased in the spaces provided below.

Model _____ Serial # _____ Sales Slip # _____

Purchased from _____ Date _____
(Retailer)

YAMAHA CORPORATION OF AMERICA
Electronic Service Division
6600 Orangethorpe Avenue
Buena Park, CA 90620

KEEP THIS DOCUMENT FOR YOUR RECORDS. DO NOT MAIL!

For details of products, please contact your nearest Yamaha representative or the authorized distributor listed below.

Pour plus de détails sur les produits, veuillez-vous adresser à Yamaha ou au distributeur le plus proche de vous figurant dans la liste suivante.

Die Einzelheiten zu Produkten sind bei Ihrer unten aufgeführten Niederlassung und bei Yamaha Vertragshändlern in den jeweiligen Bestimmungsländern erhältlich.

Para detalles sobre productos, contacte su tienda Yamaha más cercana o el distribuidor autorizado que se lista debajo.

NORTH AMERICA

CANADA

Yamaha Canada Music Ltd.
135 Milner Avenue, Scarborough, Ontario,
M1S 3R1, Canada
Tel: 416-298-1311

U.S.A.

Yamaha Corporation of America
6600 Orangethorpe Ave., Buena Park, Calif. 90620,
U.S.A.
Tel: 714-522-9011

CENTRAL & SOUTH AMERICA

MEXICO

Yamaha de México S.A. de C.V.
Calz. Javier Rojo Gómez #1149,
Col. Guadalupe del Moral
C.P. 09300, México, D.F., México
Tel: 55-5804-0600

BRAZIL

Yamaha Musical do Brasil Ltda.
Rua Joaquim Floriano, 913 - 4º andar, Itaim Bibi,
CEP 04534-013 Sao Paulo, SP. BRAZIL
Tel: 011-3704-1377

ARGENTINA

Yamaha Music Latin America, S.A.
Sucursal de Argentina
Olga Cossettini 1553, Piso 4 Norte
Madero Este-C1107CEK
Buenos Aires, Argentina
Tel: 011-4119-7000

PANAMA AND OTHER LATIN AMERICAN COUNTRIES/ CARIBBEAN COUNTRIES

Yamaha Music Latin America, S.A.
Torre Banco General, Piso 7, Urbanización Marbella,
Calle 47 y Aquilino de la Guardia,
Ciudad de Panamá, Panamá
Tel: +507-269-5311

EUROPE

THE UNITED KINGDOM

Yamaha Music U.K. Ltd.
Sherbourne Drive, Tilbrook, Milton Keynes,
MK7 8BL, England
Tel: 01908-366700

IRELAND

Danfay Ltd.
61D, Sallynoggin Road, Dun Laoghaire, Co. Dublin
Tel: 01-2859177

GERMANY

Yamaha Music Central Europe GmbH
Siemensstraße 22-34, 25462 Rellingen, Germany
Tel: 04101-3030

SWITZERLAND/LIECHTENSTEIN

Yamaha Music Central Europe GmbH,
Branch Switzerland
Seefeldstrasse 94, 8008 Zürich, Switzerland
Tel: 01-383 3990

AUSTRIA

Yamaha Music Central Europe GmbH,
Branch Austria
Schleiergasse 20, A-1100 Wien, Austria
Tel: 01-60203900

CZECH REPUBLIC/SLOVAKIA/ HUNGARY/SLOVENIA

Yamaha Music Central Europe GmbH,
Branch Austria, CEE Department
Schleiergasse 20, A-1100 Wien, Austria
Tel: 01-602039025

POLAND

Yamaha Music Central Europe GmbH
Sp.z. o.o. Oddział w Polsce
ul. 17 Stycznia 56, PL-02-146 Warszawa, Poland
Tel: 022-868-07-57

THE NETHERLANDS/ BELGIUM/LUXEMBOURG

Yamaha Music Central Europe GmbH,
Branch Benelux
Clarissenhof 5-b, 4133 AB Vianen, The Netherlands
Tel: 0347-358 040

FRANCE

Yamaha Musique France
BP 70-77312 Marne-la-Vallée Cedex 2, France
Tel: 01-64-61-4000

ITALY

Yamaha Musica Italia S.P.A.
Combo Division
Viale Italia 88, 20020 Lainate (Milano), Italy
Tel: 02-935-771

SPAIN/PORTUGAL

Yamaha Música Ibérica, S.A.
Ctra. de la Coruna km. 17, 200, 28230
Las Rozas (Madrid), Spain
Tel: 91-639-8888

GREECE

Philippos Nakas S.A. The Music House
147 Skiathou Street, 112-55 Athens, Greece
Tel: 01-228 2160

SWEDEN

Yamaha Scandinavia AB
J. A. Wettergrens Gata 1, Box 30053
S-400 43 Göteborg, Sweden
Tel: 031 89 34 00

DENMARK

YS Copenhagen Liaison Office
Generatorvej 6A, DK-2730 Herlev, Denmark
Tel: 44 92 49 00

FINLAND

F-Musiikki Oy
Kluuvikatu 6, P.O. Box 260,
SF-00101 Helsinki, Finland
Tel: 09 618511

NORWAY

Norsk filial av Yamaha Scandinavia AB
Grini Næringspark 1, N-1345 Østerås, Norway
Tel: 67 16 77 70

ICELAND

Skifan HF
Skeifan 17 P.O. Box 8120, IS-128 Reykjavik, Iceland
Tel: 525 5000

RUSSIA

Yamaha Music (Russia)
Office 4015, entrance 2, 21/5 Kuznetskii
Most street, Moscow, 107996, Russia
Tel: 495 626 0660

OTHER EUROPEAN COUNTRIES

Yamaha Music Central Europe GmbH
Siemensstraße 22-34, 25462 Rellingen, Germany
Tel: +49-4101-3030

AFRICA

Yamaha Corporation,
Asia-Pacific Music Marketing Group
Nakazawa-cho 10-1, Naka-ku, Hamamatsu,
Japan 430-8650
Tel: +81-53-460-2312

MIDDLE EAST

TURKEY/CYPRUS

Yamaha Music Central Europe GmbH
Siemensstraße 22-34, 25462 Rellingen, Germany
Tel: 04101-3030

OTHER COUNTRIES

Yamaha Music Gulf FZE
LOB 16-513, P.O.Box 17328, Jubel Ali,
Dubai, United Arab Emirates
Tel: +971-4-881-5868

ASIA

THE PEOPLE'S REPUBLIC OF CHINA

Yamaha Music & Electronics (China) Co.,Ltd.
25/F., United Plaza, 1468 Nanjing Road (West),
Jingan, Shanghai, China
Tel: 021-6247-2211

HONG KONG

Tom Lee Music Co., Ltd.
11/F., Silvercord Tower 1, 30 Canton Road,
Tsimshatsui, Kowloon, Hong Kong
Tel: 2737-7688

INDONESIA

PT. Yamaha Music Indonesia (Distributor)
PT. Nusantik
Gedung Yamaha Music Center, Jalan Jend. Gatot
Subroto Kav. 4, Jakarta 12930, Indonesia
Tel: 21-520-2577

KOREA

Yamaha Music Korea Ltd.
8F, 9F, Dongsung Bldg. 158-9 Samsung-Dong,
Kangnam-Gu, Seoul, Korea
Tel: 080-004-0022

MALAYSIA

Yamaha Music Malaysia, Sdn., Bhd.
Lot 8, Jalan Perbandaran, 47301 Kelana Jaya,
Petaling Jaya, Selangor, Malaysia
Tel: 3-78030900

PHILIPPINES

Yupangco Music Corporation
339 Gil J. Puyat Avenue, P.O. Box 885 MCPO,
Makati, Metro Manila, Philippines
Tel: 819-7551

SINGAPORE

Yamaha Music Asia Pte., Ltd.
#03-11 A-Z Building
140 Paya Lebar Road, Singapore 409015
Tel: 747-4374

TAIWAN

Yamaha KHS Music Co., Ltd.
3F, #6, Sec.2, Nan Jing E. Rd. Taipei.
Taiwan 104, R.O.C.
Tel: 02-2511-8688

THAILAND

Siam Music Yamaha Co., Ltd.
891/1 Siam Motors Building, 15-16 floor
Rama 1 road, Wangmai, Pathumwan
Bangkok 10330, Thailand
Tel: 02-215-2626

OTHER ASIAN COUNTRIES

Yamaha Corporation,
Asia-Pacific Music Marketing Group
Nakazawa-cho 10-1, Naka-ku, Hamamatsu,
Japan 430-8650
Tel: +81-53-460-2317

OCEANIA

AUSTRALIA

Yamaha Music Australia Pty. Ltd.
Level 1, 99 Queensbridge Street, Southbank,
Victoria 3006, Australia
Tel: 3-9693-5111

NEW ZEALAND

Music Houses of N.Z. Ltd.
146/148 Captain Springs Road, Te Papapa,
Auckland, New Zealand
Tel: 9-634-0099

COUNTRIES AND TRUST TERRITORIES IN PACIFIC OCEAN

Yamaha Corporation,
Asia-Pacific Music Marketing Group
Nakazawa-cho 10-1, Naka-ku, Hamamatsu,
Japan 430-8650
Tel: +81-53-460-2312



Yamaha Web Site (English only)
<http://www.yamahasyth.com/>
Yamaha Manual Library
<http://www.yamaha.co.jp/manual/>

U.R.G., Pro Audio & Digital Musical Instrument Division, Yamaha Corporation
© 2008 Yamaha Corporation

WM52900 803POTYX.X-01B0
Printed in China