

YAMAHA

SK20

SYMPHONIC ENSEMBLE
OWNER'S MANUAL

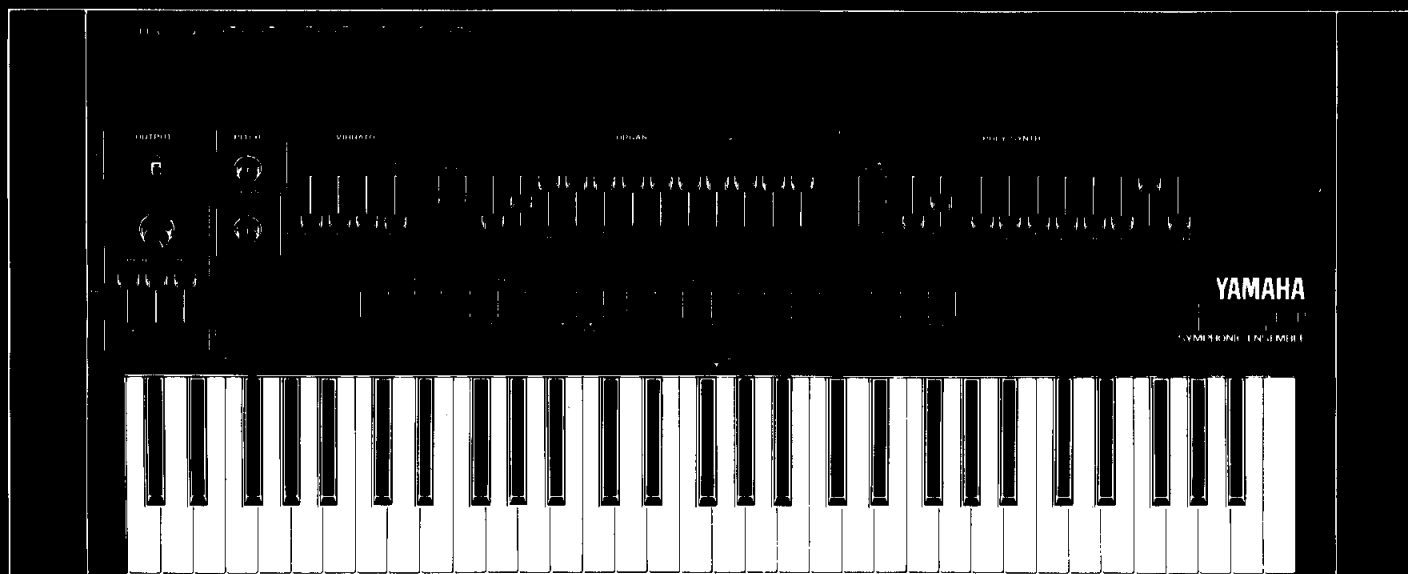

SYMPHONIC ENSEMBLE SK20

Thank you very much for your purchase of our Yamaha SK20 Symphonic Ensemble. The SK20 functions as a polyphonic synthesizer and a string synthesizer (with the POLY-SYNTH section), as well a fully controllable ORGAN. The keyboard will play up to seven notes in the normal mode, and fourteen notes in either of the KEYBOARD SPLIT modes, giving your performance a full, rich sound.

We urge that you read the contents of this Owner's Manual carefully to make full use of the functions featured on the SK20.

CONTENTS	Page
CONNECTIONS	3
How to operate OUTPUT/PITCH block	4
How to operate ORGAN block	5
How to operate POLY-SYNTH, STRING block	7
How to operate the effector block	11
BLOCK DIAGRAM	13
SPECIFICATIONS	14

OUTPUT Block

This block controls both the overall output volume and the relative mix of the ORGAN, STRING, AND POLY-SYNTH sections.

PITCH Block

These knobs control the pitch of the ORGAN and POLY-SYNTH sections independently. Since the strings sound is derived from the polyphonic synthesizer section, the POLY-SYNTH tuning also affects the pitch of the strings.

VIBRATO Block

This block controls the depth and speed of vibrato for both ORGAN and the POLY-SYNTH sections, and provides for delayed vibrato, which is very useful for realistic strings.

TREMOLO/ENSEMBLE

These controls provide chorus effects: Leslie-type TREMOLO with controllable SPEED, and rich ENSEMBLE sound.

KEYBOARD SPLIT

These controls allow the keyboard to be split with the ORGAN on the left and the POLY-SYNTH on the right, and vice versa. This gives the player a multi-instrument sound controlled from one keyboard.

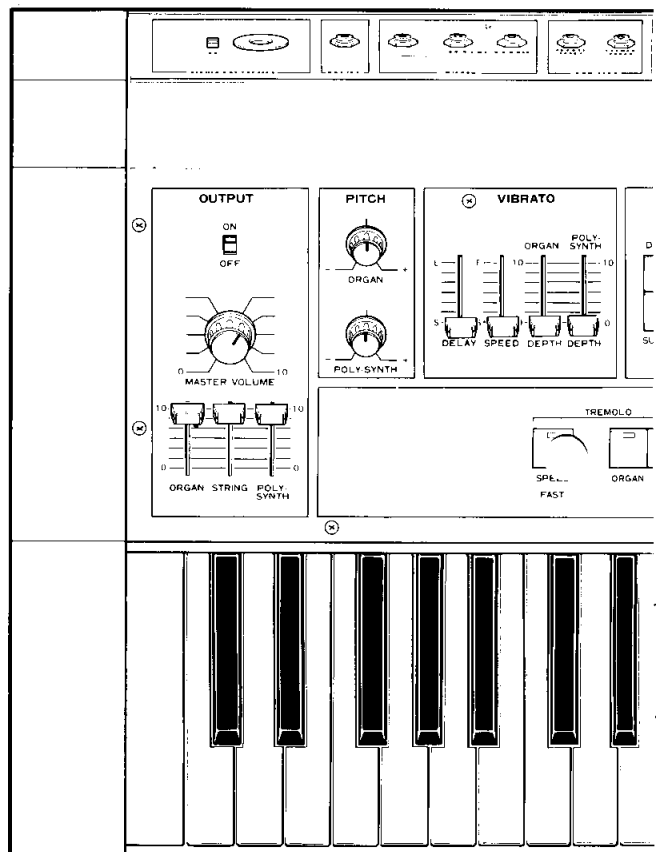

ORGAN Block

This block controls the ORGAN tone generators and filters. In one touch you can select one of three different preset organ voices, or set up your own sound in the MANUAL mode, using the 16' through 1' tone levers.

DECAY, SUSTAIN

These switches produce percussive type delayed effects, or sustained sounds after the keys are released.

BRILLIANCE

This lever controls the overall brilliance of both the presets and the MANUAL organ sounds.

PERCUSSIVE

This lever adds percussion to both the presets and the MANUAL organ sounds.

16' – 1' TONE LEVERS

These levers the volume of the various ORGAN "footages" with a drawbar type action.

POLY-SYNTH Block

This block controls the polyphonic and string synthesizer sections. All levers positioned to the right of the BRILLIANCE operate when in the MANUAL mode.

SLOW ATTACK, SUSTAIN

These controls alter the envelope settings of the preset STRING and POLY-SYNTH voices. They add a slow attack time, and a release time controlled by the SUSTAIN slider.

BRILLIANCE

This lever controls the overall brilliance (VCF cutoff) of the STRING and POLY-SYNTH presets, and the brilliance of your voicing when in the MANUAL mode.

FEET

Selects the sound source when in the MANUAL mode, by changing both frequency and waveform.

CUTOFF FREQUENCY, RESONANCE

These control the basic tone when in the MANUAL mode by altering the cutoff frequency and the resonance (emphasis around the cutoff frequency) of the VCF.

ENVELOPE GENERATOR (ADSR)

These levers allow complete control of the attack time, decay time, sustain level, and release time of the VCF envelope.

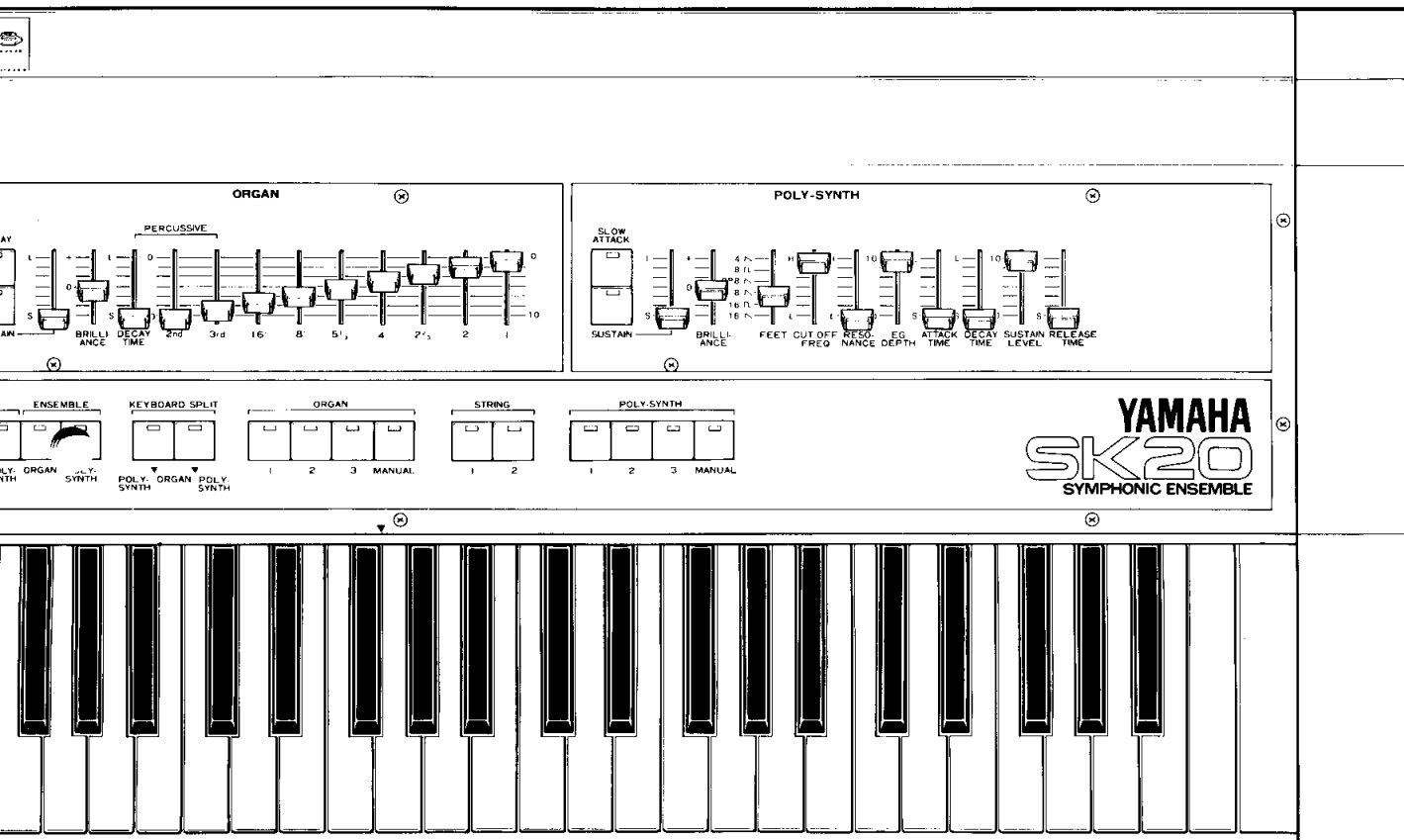

REAR PANEL

The SK20 rear panel provides jacks for output to your sound system, a standard Leslie speaker system, and connections for foot pedal control of volume and sustain.

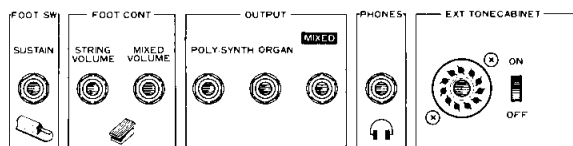

CONNECTIONS

When playing the SK20 without headphones, the connection of an external power amplifier such as a keyboard amplifier and a speaker system are required.

POWER CONNECTION

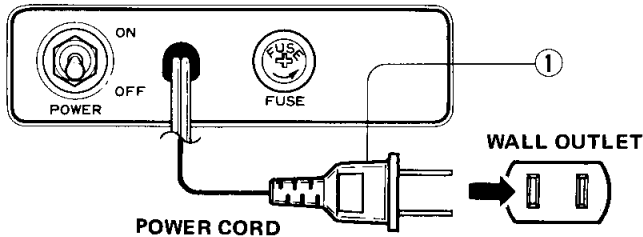

① POWER Cord

Plug the power cord into an A.C. mains (50 or 60 Hz).

Remark on Fuse

If the fuse blows, it may be caused by a malfunction within the SK20 – please refer to your nearest Yamaha service center.

CONNECTION OF AMPLIFIERS and SPEAKER

OUTPUT Block

The output is a low impedance (600 ohm), unbalanced, standard tip/sleeve phone jack, with a nominal output level of -10 dB. It will drive low impedance or high impedance inputs, either balanced or unbalanced.

② MIXED output

This jack should be used when using a single input on a mixer, or a single musical instrument amplifier. It carries the audio from both the ORGAN and POLY-SYNTH sections.

③ SPLIT output

These jacks allow the use of separate input channels on a mixer or separate amplifiers to process the ORGAN and POLY-SYNTH signals. This provides for independent control of the two sections, and allows the use of different auxiliary effects devices.

④ PHONES output

This is a standard headphone output jack compatible with most stereo headphones. The signal it carries is the same as that at the MIXED output. Refer to the section on the OUTPUT block for further details.

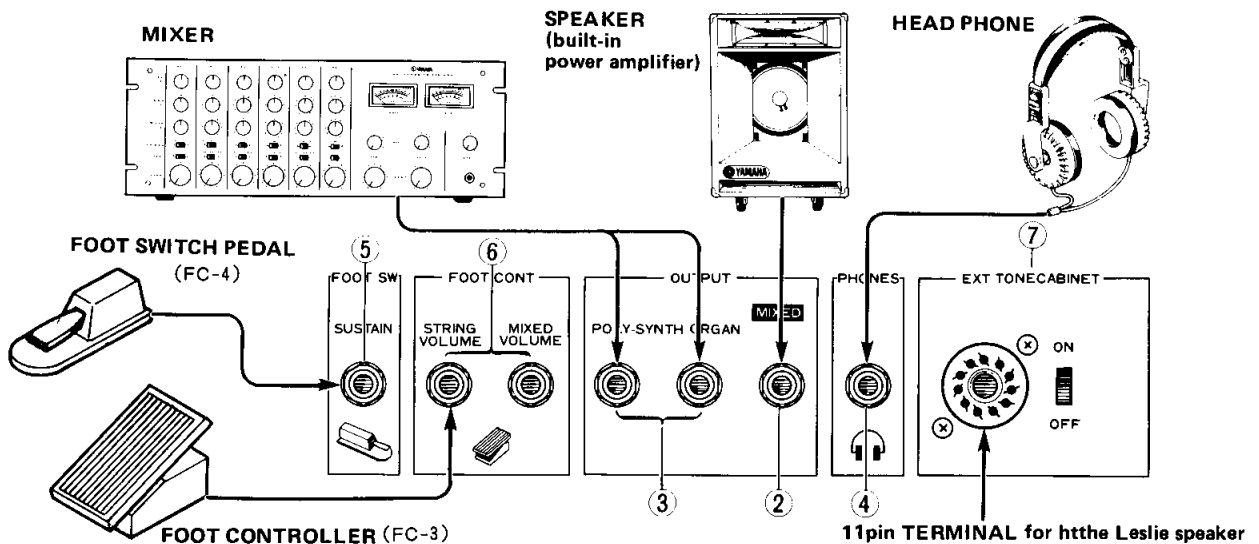

CONNECTION OF OPTIONAL ACCESSORIES

⑤ FOOT SW, SUSTAIN (Foot switch)

An on/off foot switch (such as Yamaha FC-4) can be connected here to control the SUSTAIN functions on the ORGAN and POLY-SYNTH sections.

⑥ FOOT CONTROL

A volume pedal (such as Yamaha FC-3) can be connected here to control the volume of the MIXED output signal, or the STRING VOLUME separately.

⑦ EXTERNAL TONE CABINET

This is a standard 11-pin connector for use with a Leslie speaker system, (2-channel input type). When the Leslie speaker is connected to the SK20 and the EXT TONE CABINET on/off switch is ON, the speed of the rotating speaker can be controlled by the SPEED switch on the SK20 front panel. Please refer to the TREMOLO/ENSEMBLE section of this manual for further details.

How to operate OUTPUT/PITCH block

When connections to your sound system or musical instrument amplifier are complete, please check for any incorrect connections. It is a good idea to try the controls and their affect on the sound as you go through the remaining sections of this manual.

1 POWER (Power switch)

The power switch is ON when in the upward position. When the power is turned on, the initial setup shown below is automatically set: ORGAN 1, STRING 1, and POLY-SYNTH 1.

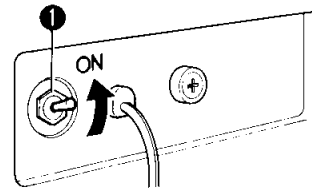

INITIAL SET

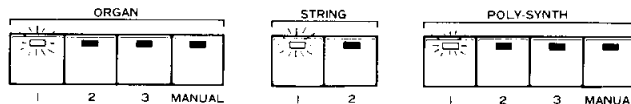

All switches are automatically set to "1" when the power is ON.

OUTPUT block

This block controls the volume of the ORGAN, POLY-SYNTH, and STRINGS separately, and the overall level of the MIXED output.

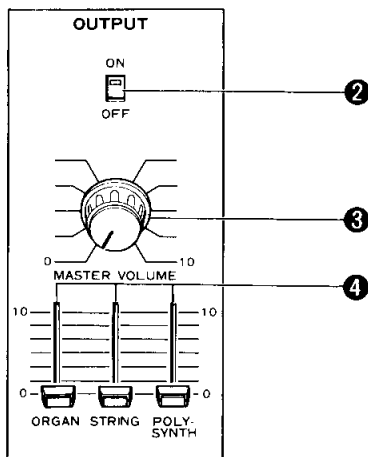

2 LINE OUT switch

This switch must be ON to allow a signal to be obtained at the output jacks on the rear panel. It can be set to OFF when using headphones for private practice.

3 MASTER VOLUME

This controls the overall volume of both the MIXED output and the headphone output.

4 ORGAN, STRING, and POLY-SYNTH mixing levers

This block allows independent mixing of the signals from the ORGAN, STRING, and POLY-SYNTH sections.

- These levers also control the sound volume of split output (ORGAN, POLY-SYNTH).

PITCH block

The block works on tuning when the SK20 is played in combination with other musical instruments.

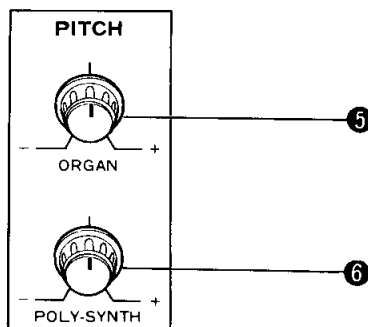

5 ORGAN (Organ pitch)

Adjust the pitch of the ORGAN tone generators.

6 POLY-SYNTH (Polyphonic synthesizer pitch)

Adjusts the pitch of both the STRINGS and the POLY-SYNTH together.

DETUNE effect

By detuning the POLY-SYNTH pitch, chorusing and harmony effects can be obtained.

How to operate ORGAN block

The ORGAN section has three presets plus a MANUAL mode. When the power switch is turned ON, ORGAN 1 is automatically set. When you first try the ORGAN presets, make sure that DECAY and SUSTAIN are off, BRILLIANCE is at the center or 0 position, and that the ORGAN level control in the OUTPUT block is up.

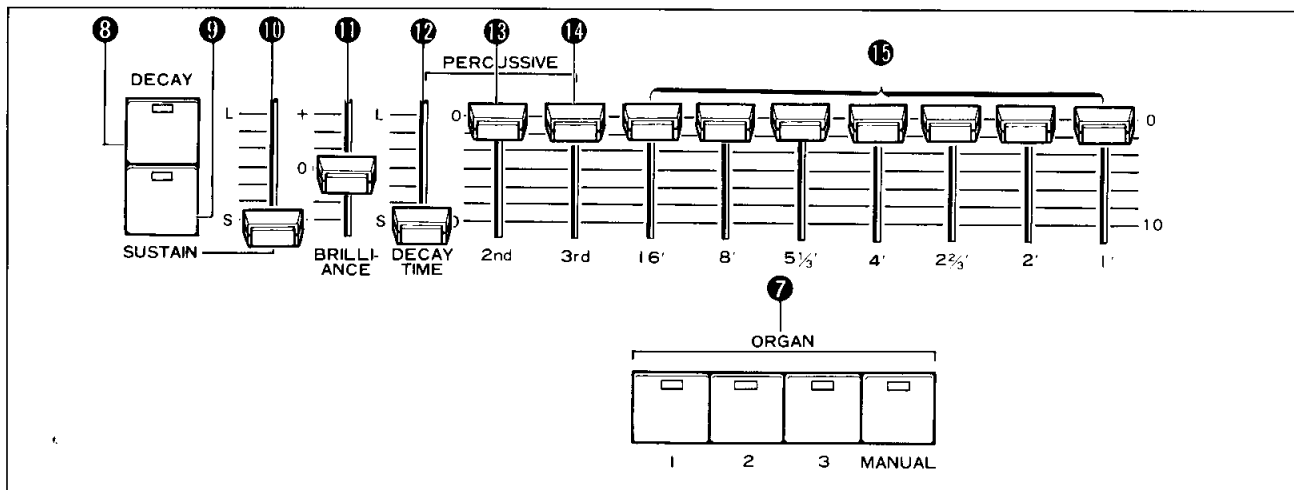

7 ORGAN switches

ORGAN 1, ORGAN 2, and ORGAN 3 are preset organ voicings with different settings of the various "footages". When the MANUAL switch is depressed, all the controls in the ORGAN block will control the sound. When in any of the preset modes, only the controls to the left of the 16' - 1' levers will affect the sound.

8 DECAY switch

When the DECAY switch is depressed (the red LED indicator will light), percussion-instrument type decay will affect the sound of the ORGAN voices (or your settings in the MANUAL mode). The volume reaches maximum just after the keys are depressed, and while the keys are still down the volume will lower gradually, as controlled by the DECAY TIME lever 10. The sound will then disappear when the keys are released. This effect is turned off when the DECAY switch is pushed again. Refer to the drawing below for graphs of the DECAY and SUSTAIN functions.

9 SUSTAIN switch

When the SUSTAIN switch is pushed on, the sound or the ORGAN will sustain after the keys are released, as shown in the graph below. The amount of sustain is likewise controlled by the SUSTAIN lever 10 to the right of the DECAY and SUSTAIN switches. This function is also turned off by pushing the button a second time.

- When both the DECAY and SUSTAIN functions are switched on, the sound will still decay regardless of when the keys are released.

10 DECAY, SUSTAIN levers

As described above, these levers control the DECAY time and SUSTAIN amount, respectively. The further toward the "L" the slider is set, the longer the period of time.

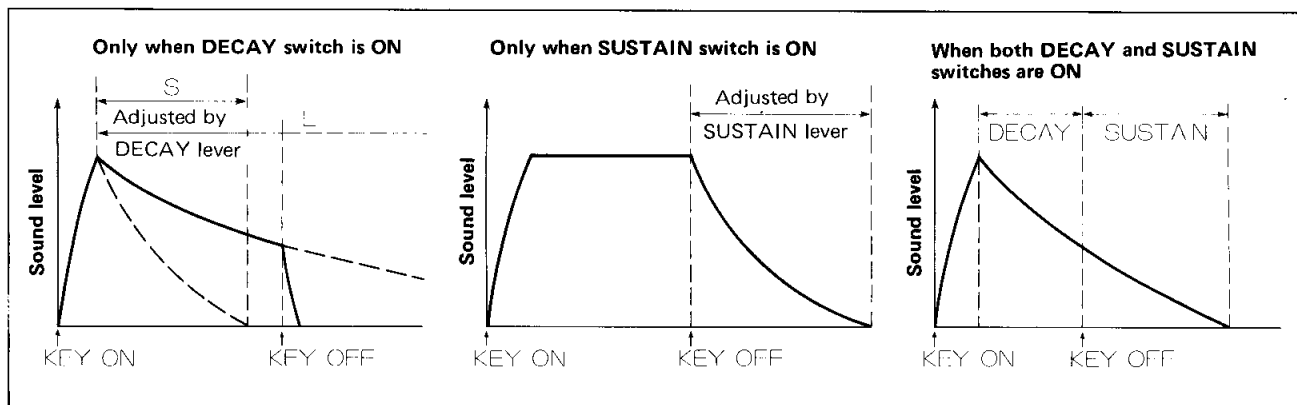

ORGAN block

11 BRILLIANCE lever

This lever adjusts the tone quality by varying the filter cutoff. When the lever is set to the + side, the sound of the organ voices (and your MANUAL settings) will become brighter, with more harmonics. When set to the - side, the BRILLIANCE control will make the sound softer, with less harmonics.

- Initially, this lever is usually positioned at the 0 or center position. A click stop is provided for this purpose.

12, 13, 14 PERCUSSIVE: DECAY TIME, 2nd, and 3rd levers

These levers add a percussive tone at either the 2nd or 3rd harmonic interval to both the preset voices and the MANUAL settings. These levers, as well as the 16' - 1' levers 15, operate by pulling them toward you, similar to organ-type drawbars. Thus, as you move the PERCUSSIVE sliders downwards (towards 10), they will add more of the percussion to the ORGAN sound. As shown in the graph below, the percussion occurs immediately when the keys are depressed, and decays at the rate set by the DECAY TIME slider. This control affects the decay of the percussive sound even when the DECAY button is off.

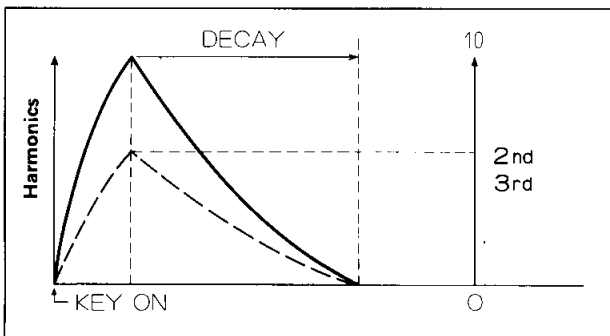

- If the key which actuated the percussive sound is not released, another percussive sound will not be generated until that key (or keys) is released.

15 TONE levers (16' - 1')

These levers control the relative amount of sound at the various "footages", and operate only when in the MANUAL mode. The tonal quality of an organ voicing depends on the frequency and volume of the harmonics to the fundamental (8') tone. The further toward 10 the TONE sliders are moved, the greater the strength of that harmonic.

EXAMPLE 1

How to create the piano sound

- Depress ORGAN 1 switch
- Set DECAY switch to ON
- Set DECAY, SUSTAIN lever fully to L side.

With this setting, piano-like decayed sounds can be obtained. It is acceptable that the 2nd percussive lever is turned slightly downwards to emphasize attack sounds to some extent.

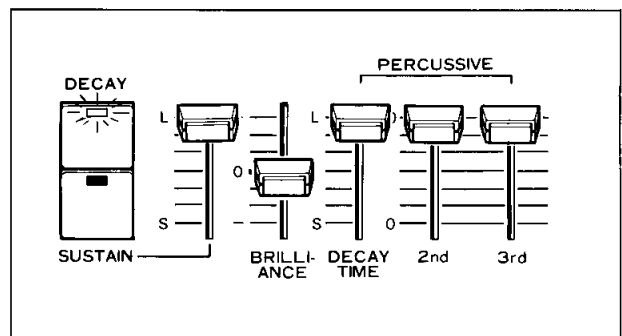

EXAMPLE 2

"Vibrato-full" sound

Tone levers are set as in the figure below, after MANUAL button is depressed. This leads to an effective

VIBRATO, because high ranges are emphasized. Set the levers in VIBRATO block as in the figure in order apply DELAY VIBRATO.

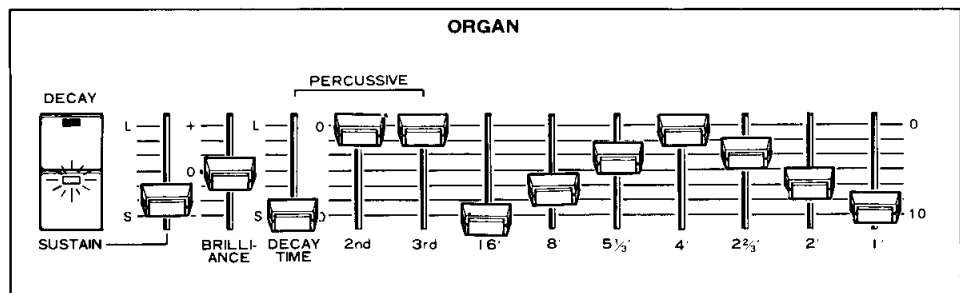
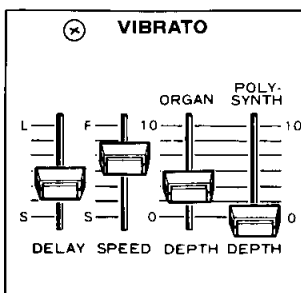

How to operate POLY-SYNTH, STRING block

The POLY-SYNTH section of the SK20 produces both strings and polyphonic synthesizer-type sounds. It consists of 2 STRING presets, 3 POLY-SYNTH presets (which are brass-like), and a MANUAL mode in which your own voicings can be programmed with the sound source, filter, and envelope controls.

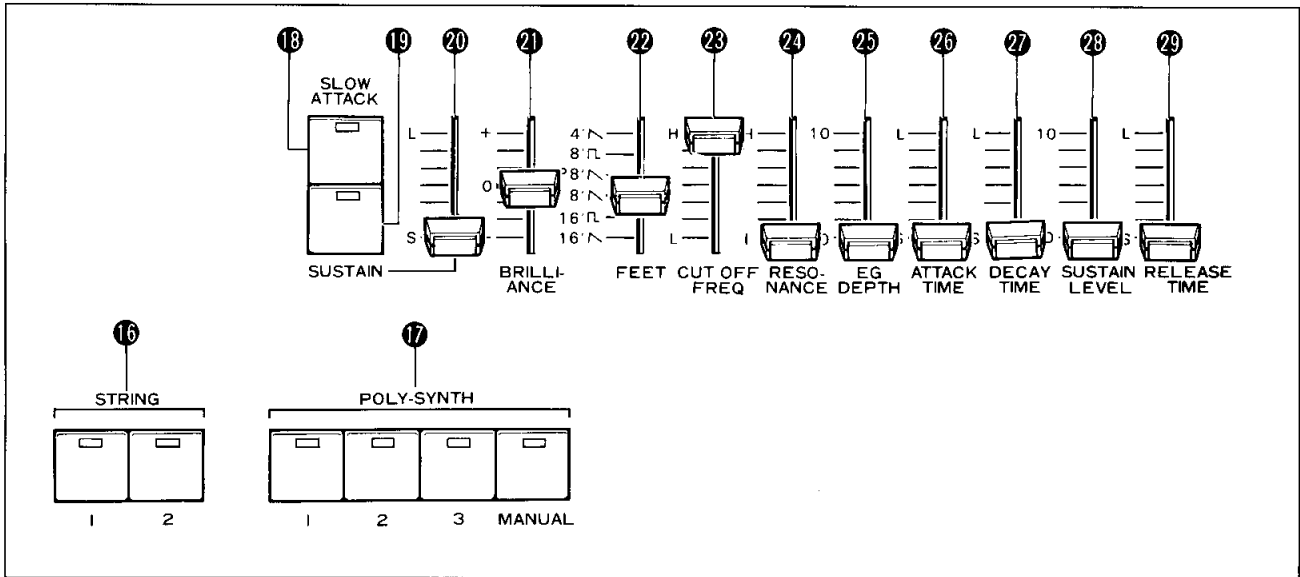

16 STRING switches

Either STRING 1 or STRING 2 can be selected (they differ by one octave in frequency). When the power is first turned on, STRING 1 is automatically selected.

17 POLY-SYNTH switches

These switches allow selection of POLY-SYNTH presets 1, 2, and 3, and the MANUAL mode.

- Although the tone generators for the STRING and POLY-SYNTH sections are the same, the volume of the STRING section can be controlled independently of the POLY-SYNTH sounds with either the STRING mixing lever in the OUTPUT block, or a volume controller connected to the STRING VOLUME jack on the rear panel. This enables you realistically control fade-in and fade-out of the string sound.

18 SLOW ATTACK switch

When this switch is pushed on, it slows down the attack time of both the POLY-SYNTH and STRING presets, and the voice settings in the MANUAL mode. SLOW ATTACK is quite useful for realistic strings, and gives a gradual rise time regardless of the position of the SUSTAIN lever 20. The attack time will return to normal when this button is pushed again.

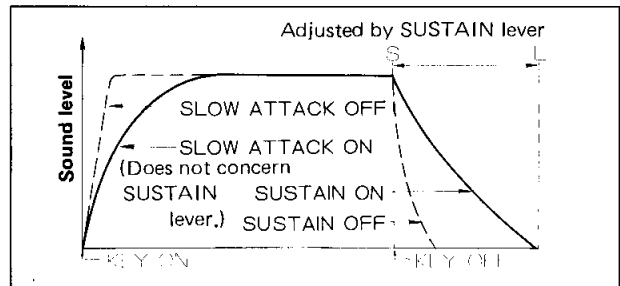

19, 20 SUSTAIN switch, lever

The SUSTAIN switch and lever perform identically to their corresponding controls in the ORGAN block: when the SUSTAIN switch is depressed, the sound will sustain after the keys are released, and the length of the sustain is controlled by the SUSTAIN lever.

21 BRILLIANCE lever

This lever adjusts the overall VCF cutoff frequency, and affects the brilliance, or amount of harmonics, of both the preset sounds (STRING and POLY-SYNTH) and the settings in the MANUAL mode. This control is normally set to the middle (0), and the brightness of the sound can then be adjusted.

- SLOW ATTACK 18, SUSTAIN 19, SUSTAIN levers 20, and the BRILLIANCE lever 21 equally control the STRING and POLY-SYNTH sounds.

POLY-SYNTH, STRING block

Levers 22 to 24 to the right of the BRILLIANCE lever 21 all operate only when POLY-SYNTH switch is set to MANUAL. According to the position the levers are set, sometimes sounds do not come out even when MANUAL switch is depressed. Before operation, set the levers as shown in the figure page 7, and then set MANUAL switch to ON.

22 FEET switch

This selects the sound range, waveform and filter mode for a sound source. When it is set 8', a standard sound range of 5 octaves between C1 – C6 is covered, while when set 16', the sound range is lowered by 1 octave. On the contrary, when set to 4', the sound range is raised by 1 octave.

WAVE FORM

Sound waveforms consist of sawtooth (\sphericalangle) and square (\sqcap) waves. The sawtooth wave has integral-fold harmonics and is a wave used as a sound source for general musical instruments such as string instruments. The square wave, however, has odd-fold harmonics and its tone resembles that of wind-instruments such as a clarinet.

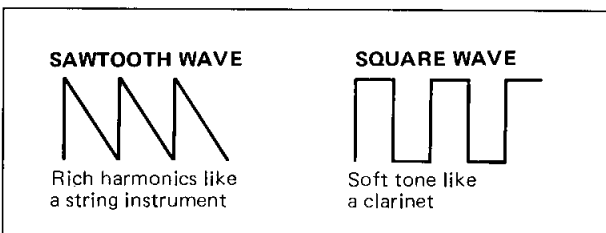

FILTER

The function of a filter is to cut a part of the harmonics to approximate them to the desired tones. While a low pass filter (LPF) plays an integral part by removing harmonics higher than a certain level, A band-pass filter (BPF) can be used only for 8' sawtooth waveform. The BPF is used when only a certain range of harmonics is utilized in sound creations.

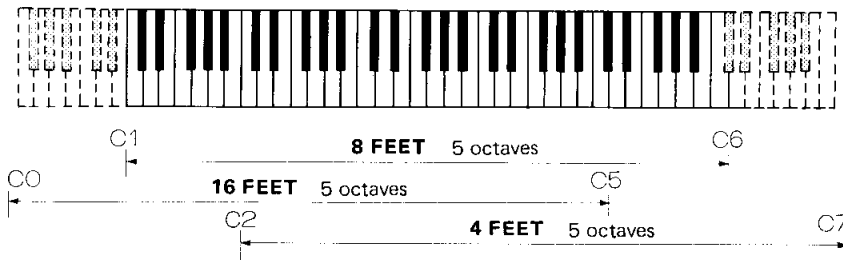
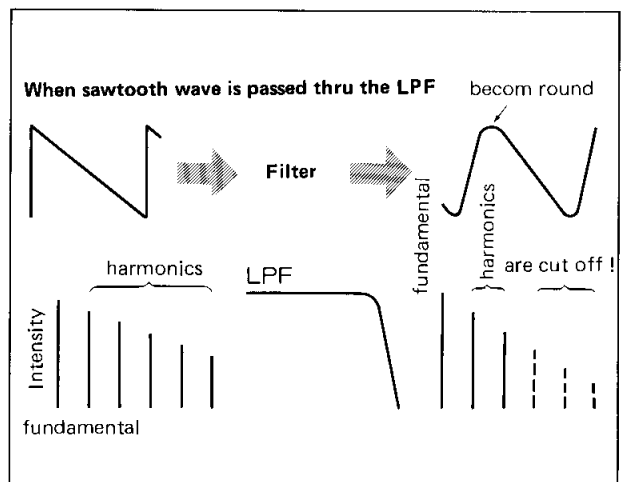

Check by actually changing FEET switch to hear the difference between tones and sound range created by waveforms. And then, read the following explanations, setting the lever to 8'.

23 CUT OFF FREQ (Cut off frequency)

The lever controls tone quality which is a basic factor for manual operations. The higher harmonics are cut when the lever is set from H side to L, resulting in smooth and soft tones. When the lever is set fully to L, sounds are not produced because the fundamental tone is also cut.

24 RESONANCE

When the lever is set to H, the harmonics close to cutoff frequencies are emphasized so that vivid and sweet tones can be obtained.

The sound changes through the use of the lever differ according to the position of CUT OFF FREQ lever 23. By setting RESONANCE lever fully to H, and raising and lowering CUT OFF FREQ lever 23, while playing certain keys, the volume reaches maximum at a certain point. This is called the resonance point of the filter.

If CUT OFF FREQ lever is set further towards H, wailing sounds inherent in synthesizers appear.

In the above mentioned examples CUT OFF FREQ lever is shifted up and down manually, but ENVELOPE GENERATOR will perform the operation electrically.

POLY-SYNTH, STRING block

Lever from EG DEPTH 25 to RELEASE TIME 29 control an envelope generator that provides temporal changes to tone quality from the time sounds fade in, to the time they fade away.

Set CUT OFF FREQ lever 23 fully to L and RESONANCE lever 24 fully to H in order to check the envelope generator operation, At this time, no sounds are produced even if the keys are depressed.

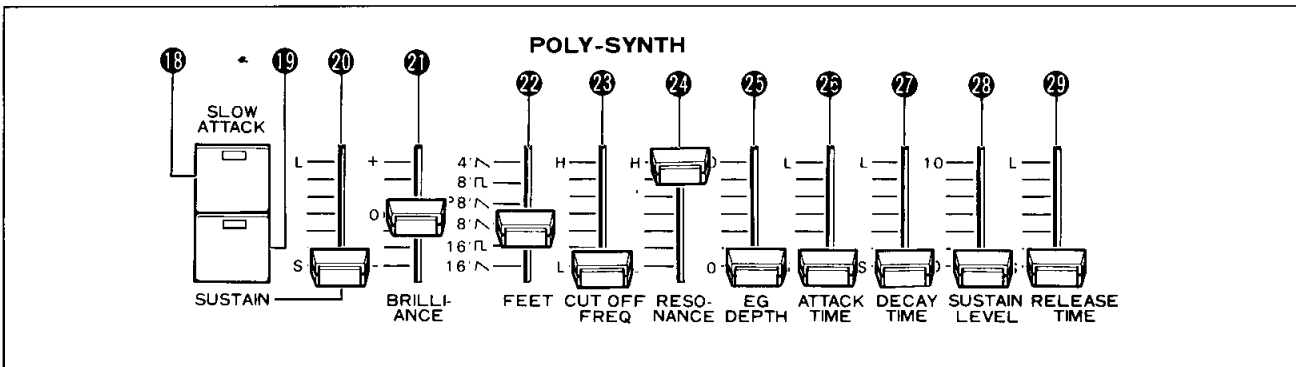

25 EG DEPTH

The lever regulates the percentage of which the cutoff frequency of the envelope created by the four levers to the right, is changed. Moving this lever from 0 towards 10 increased the degree of the change.

Raise the lever to 10 and no sound will be produced even when depressing the keys.

26 ATTACK TIME

This lever regulates the time in which the maximum change of tone-color is reached after the keys are depressed. Moving the lever towards L increases the change.

To test this, set the lever to L and play the keyboard. A hooting and wailing sound will be produced and suddenly cut off. The length of the process must change according to the lever position.

Let us proceed to the next procedure, setting back the lever to S.

27 DECAY TIME

This lever adjusts the length of time between the maximum change and stabilized sustained tones. Tone quality is slowly stabilized when the lever is set upward to L.

When the lever is set L, sound changes in process reverse to the on seen in ATTACK. However, sounds finally fade away. Sound changes in both directions can be easily heard if both ATTACK TIME and DECAY TIME levers are set fully to L. Set back the lever to S when starting the next procedure.

28 SUSTAIN LEVEL

This lever adjusts sustained tones while the keys are depressed after the tone changes by ATTACK and DECAY are completed.

When SUSTAIN LEVEL lever is set upward to 10 and the keys are depressed, tone quality changes according to the levers position. At this time, tone changes become the same as when CUT OFF FREQ lever 23 is shifted up and down, with SUSTAIN LEVEL lever set to 0, test this.

The lever determines a constantly sustained tone quality during the time the keys are kept depressed. The changes as illustrated in the figure below may occur if above explained ATTACK TIME, DECAY TIME and SUSTAIN LEVEL are set at the same time.

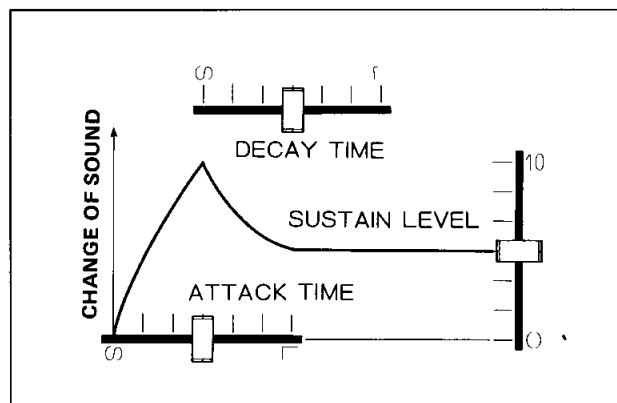

29 RELEASE TIME

The lever adjusts the time of tone changes from the time the keys are released until sounds fade away.

POLY-SYNTH, STRING block

Even if RELEASE TIME lever is set upward to L, desired effects cannot be obtained because sounds fade away at the time the keys are released. To cope with this, set SUSTAIN lever ② upward as in RELEASE TIME lever, putting SUSTAIN switch to ON. As a result, sound changes can be heard the instant the keys are released.

These changes can be displayed as an envelope curve seen in the figure to the right.

- If an envelope has been applied by depressing the keys, it will not be changed by depressing next tone keys. And a release time after keys are released starts with the timing of the finally-released tone when the keys are all released.

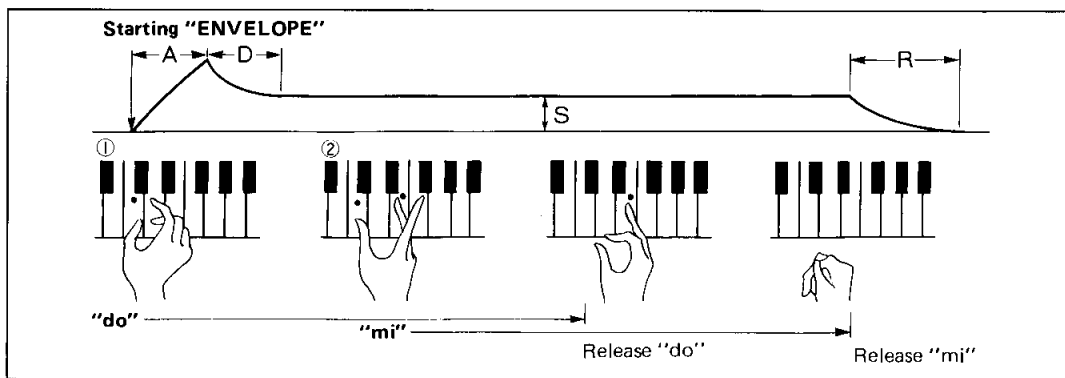
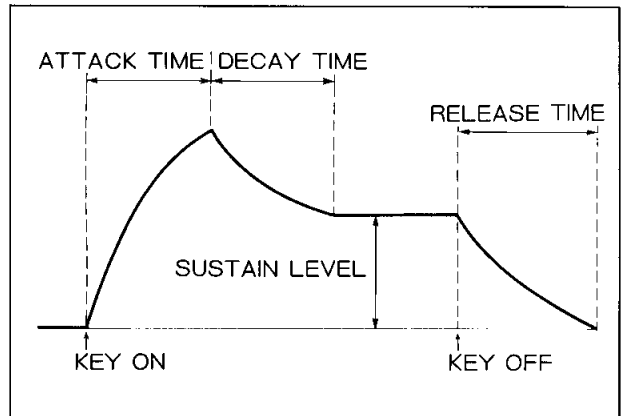

EXAMPLE

Because brass-like tones are involved in the preset tones, let us create such a light sound as clarinet.

- Turn MANUAL switch to ON.
 - As a sound source, choose 16'FL by FEET switch.
 - Set CUT OFF FREQ and RESONANCE of the filter as in the figure.
- Set the envelope generator to a certain point using EG DEPTH, A, D, S and R in order to vary tone quality.

- After the keys are released, turn SUSTAIN switch to ON, and raise the lever slightly so that the sound is not cut off.

Now, everything is ready. Further fine tuning is also recommended using each lever to obtain desired tones. Especially, CUT OFF FREQ and RESONANCE levers will cause a delicate tone difference.

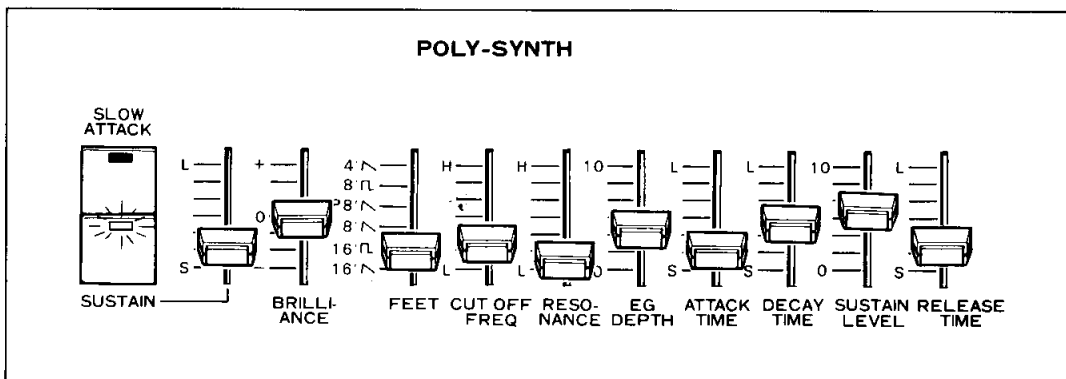

How to operate the effector block

The SK20 has chorus-type effects functions such as TREMOLO and ENSEMBLE, as well as VIBRATO and delayed VIBRATO. Furthermore, when the optional Leslie speaker system is connected to the terminal on the rear panel, the speed of the Leslie rotating speaker can be controlled from the control panel of the SK20.

VIBRATO block

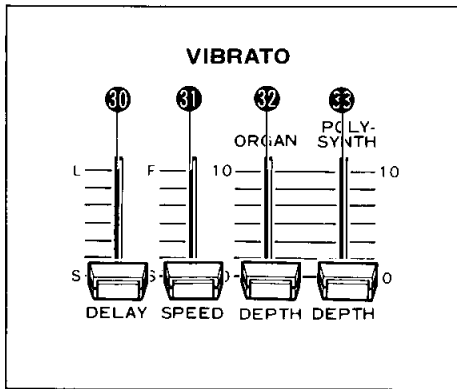

30 DELAY

This allows the vibrato to occur after the keys are played. When this lever is set to S, the vibrator will be heard almost instantaneously; when moved towards L, the delay before the vibrator occurs will be longer.

31 SPEED

This lever determines the speed of the VIBRATO. The more towards F this slider is moved, the faster the VIBRATO.

32 ORGAN DEPTH

This slider controls the amount, or depth, of the VIBRATO applied to the ORGAN sound. The further toward 10 this is set, the deeper the ORGAN VIBRATO.

33 POLY-SYNTH, STRING DEPTH

Controls the depth of VIBRATO applied to both the STRING presets and the POLY-SYNTH sounds (both presets and MANUAL).

TREMOLO/ENSEMBLE

TREMOLO and ENSEMBLE effects can be independently applied to both ORGAN and POLY-SYNTH/STRING block. At this time, however, TREMOLO and ENSEMBLE effects can not be used at the same time when only the SK20 is played. In this case, a higher priority is given to ENSEMBLE. TREMOLO and ENSEMBLE effects are not applied to SPLIT output (POLY-SYNTH, ORGAN), but only to MIXED output at the rear panel.

TREMOLO

The block controls an optional Leslie speaker system connected to the EXT TONECABINET terminal at the rear panel, in addition to TREMOLO effect. Make sure to set EXT TONECABINET switch on the rear panel to OFF when TREMOLO is applied by the SK20 without using the Leslie speaker. When the switch is turned to ON, controls in TREMOLO block work only for the Leslie speaker system, ceasing to apply TREMOLO to the SK20 itself.

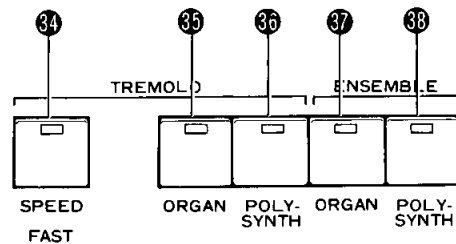
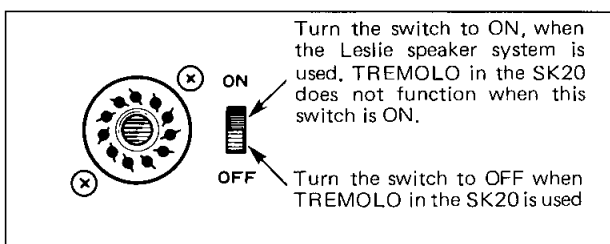

34 SPEED switch

This switch electronically shifts the TREMOLO speed. When an indicator lamp lights up by depressing the switch, the speed gradually increases. When the switch is depressed while the indicator lamp is on, the speed is reduced.

- The switch also remotely controls the revolution speed of the speaker system connected to EXT TONECABINET terminal.

The effectors

35, 36 ORGAN, POLY-SYNTH/TREMOLO switches

TREMOLO is applied when this switch is depressed, and is turned off when the switch is pushed a second time.

- When either ENSEMBLE switch is ON, the ENSEMBLE effect will take precedence over the TREMOLO, even if it is ON.
- When a Leslie speaker system is connected to the EXT TONE CABINET terminal, and the EXT CABINET switch is set to ON, on/off operation for the Leslie is controlled as indicated by the light in the TREMOLO switches.

ENSEMBLE

A deep chorus-type effect is applied to the sound through the incorporation into the SK20 of an analog delay device.

37 ORGAN, 38 POLY-SYNTH/ENSEMBLE switches

ENSEMBLE is applied when an indicator lamp lights up by depressing the switch, and is released by depressing the switch again.

- When either ENSEMBLE switch 37 or 38 is ON, TREMOLO switch 35 or 36, which is ON, is switched to OFF to be released.

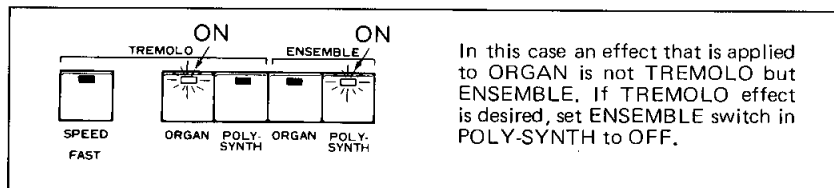

KEYBOARD SPLIT block

The *KEYBOARD SPLIT* function enables independent performance with both the *ORGAN* and *POLY-SYNTH/STRING* section, splitting them at the center position marked by a small triangle on the front panel. When either *KEYBOARD SPLIT* mode is utilized, up to fourteen notes may be played at once—seven each on the left and right side of the keyboard.

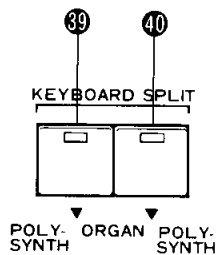

39 40 KEYBOARD SPLIT switches

When *KEYBOARD SPLIT* switch 39 is depressed, the right part from the center position ▼ of the keyboard functions as *ORGAN*, while the left functions as *POLY-SYNTH/STRING*. On the contrary, when switch 40 is depressed, the right half functions as *POLY-SYNTH/STRING*, while the left half functions as *ORGAN*. When the switch is depressed again, the unit is turned to the normal mode.

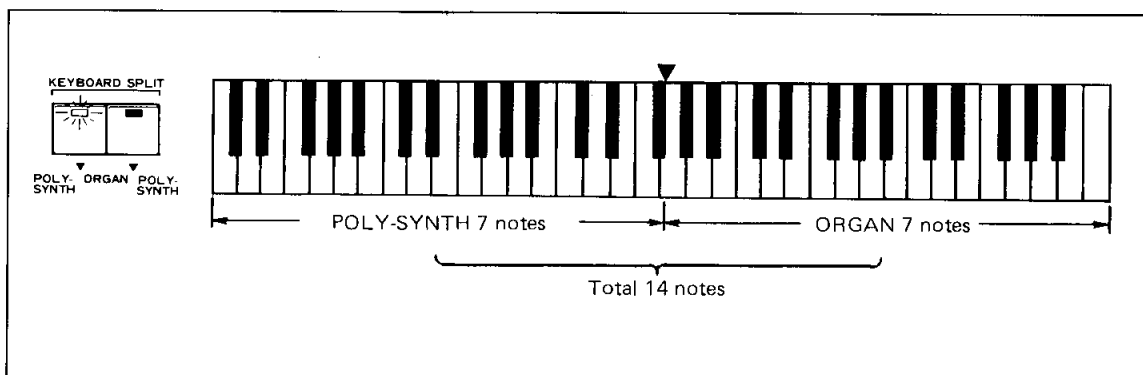

BLOCK DIAGRAM

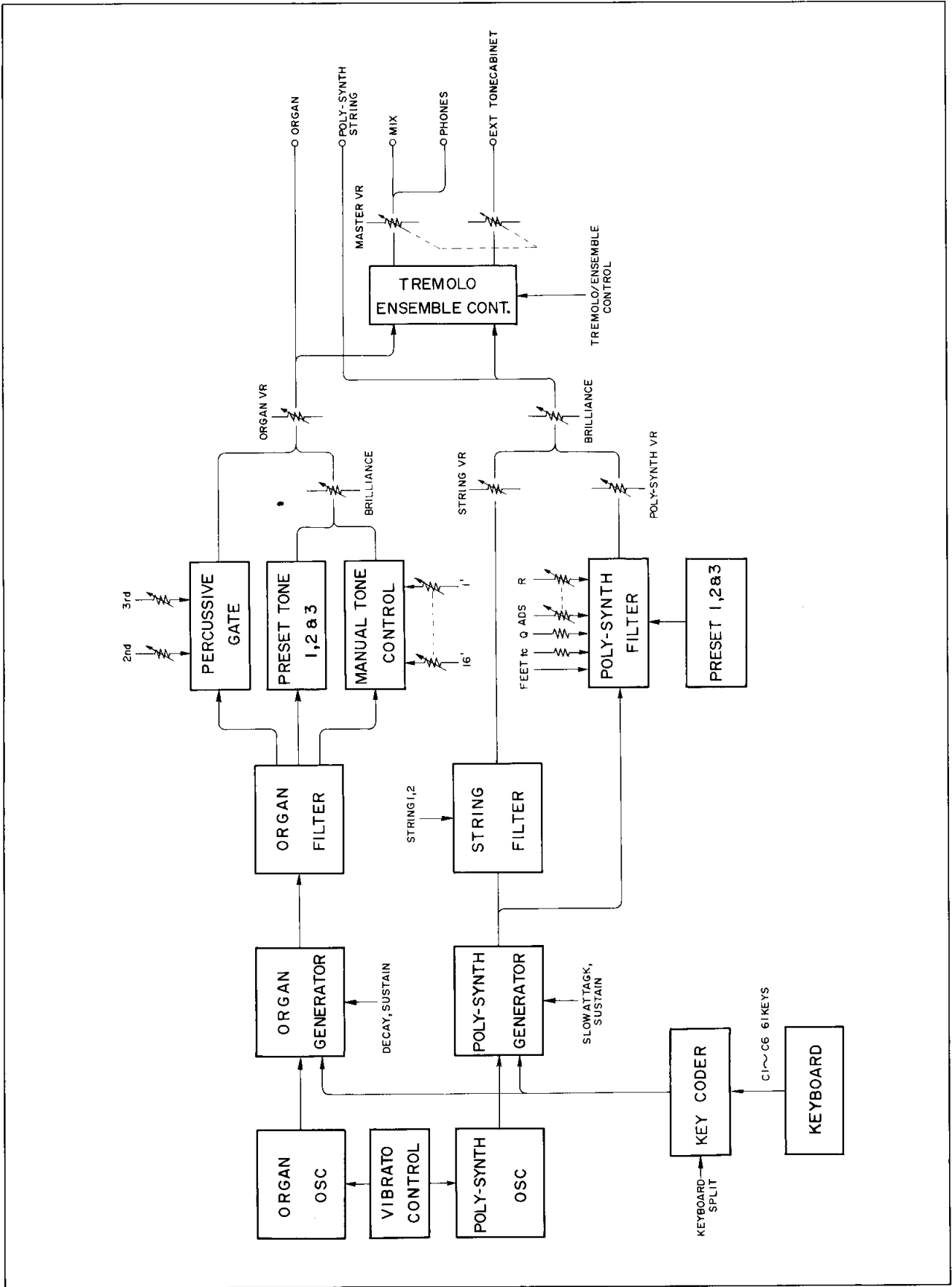

SPECIFICATIONS

KEYBOARD 61 keys, C1 ~ C6, 5 octaves

ORGAN block

Tone lever 16', 8', 5'-1/3, 4', 2'-2/3, 2', 1'
PERCUSSIVE 2nd, 3rd, DECAY TIME lever
DECAY TIME : 0.1 ~ 0.75 sec
Brilliance BRILLIANCE lever
Sustain SUSTAIN lever ; 30msec ~ 1.6 sec
SUSTAIN switch ; ON/OFF
Decay DECAY switch ; ON/OFF
DECAY lever (commonly use SUSTAIN lever)
Tone switch . . . ORGAN1, ORGAN 2, ORGAN 3 and
MANUAL

POLY-SYNTH block

FEET 4N / 8L / 8 BN / 8N / 16L / 16N
VCF Filter : BP ; ±6dB/oct.
LP ; -12dB/oct.
CUTOFF FREQ : Variable range ; 10oct.
RESONANCE : Q ; 0.5 ~ 10
EG DEPTH : Variable range ; 10oct.
Envelope generator ATTACK TIME : 3msec ~ 3sec
DECAY TIME ; 30msec ~ 30sec
SUSTAIN LEVEL ; 0 ~ 10
RELEASE TIME ; 30msec ~ 30 sec
Brilliance BRILLIANCE lever
Sustain SUSTAIN lever ; 30msec ~ 1.6sec
SUSTAIN switch ; ON/OFF
Slow attack SLOW ATTACK switch
Tone switch POLY-SYNTH 1/POLY-SYNTH 2/
POLY-SYNTH 3/MANUAL
STRING 1/STRING 2

OUTPUT block

Mixing control ORGAN/STRING/POLY-SYNTH
Master volume Control MIXED output
Line switch ON/OFF

PITCH block

ORGAN/POLY-SYNTH 435Hz ~ 450Hz

Specifications and design are subject to change without notice for improvement.

VIBRATO block

DELAY 0 ~ 3.2sec
SPEED 5 ~ 7Hz
DEPTH ORGAN ; ±40cents
POLY-SYNTH ; ±40cents

ENSEMBLE/TREMOLO block

ENSEMBLE ORGAN switch ; ON/OFF
POLY-SYNTH switch ; ON/OFF
TREMOLO ORGAN switch ; ON/OFF
POLY-SYNTH switch ; ON/OFF
SPEED switch ; FAST/SLOW

KEYBOARD SPLIT function

POLY-SYNTH ORGAN ; ON/OFF
ORGAN POLY-SYNTH ; ON/OFF
Split between F# and G marked ▼

REAR PANEL

OUTPUT terminals MIXED ; -10dBm
ORGAN
POLY-SYNTH
PHONES
EXT TONE CABINET 11pins connector,
ON/OFF switch
Connectable the Leslie models 415, 715, 815 or
equivalent (2-ch, 11pin type)
FOOT CONT MIXED volume
STRING volume
SUSTAIN foot switch

Usable tones Seven notes at normal
Seven plus seven notes at
KEYBOARD SPLIT switch to on

OTHERS

Power source USA and Canadian model ; 120V 60Hz
General model ; 110V ~ 130V
or 220V ~ 240V selectable ; 50/60Hz
Power consumption USA model ; 30W
Canadian model ; 35VA
General model ; 35W
Dimensions 1000(W) x 158(H) x 406(D) mm
39-3/8(W) x 6-1/4(H) x 16(D) inch
Weight 15kg, 33lbs
Finish Semi-gloss black panels,
rosewood grain cabinet

SINCE 1887  **YAMAHA**
NIPPON GAKKI CO., LTD. HAMAMATSU, JAPAN