

YAMAHA

MC-Series Mixing Consoles

Tables de mixage de la série MC

Mischpulte der MC-Serie

MC802

MC1202

MC1602

Operating Manual

Manuel d'utilisation

Bedienungsanleitung

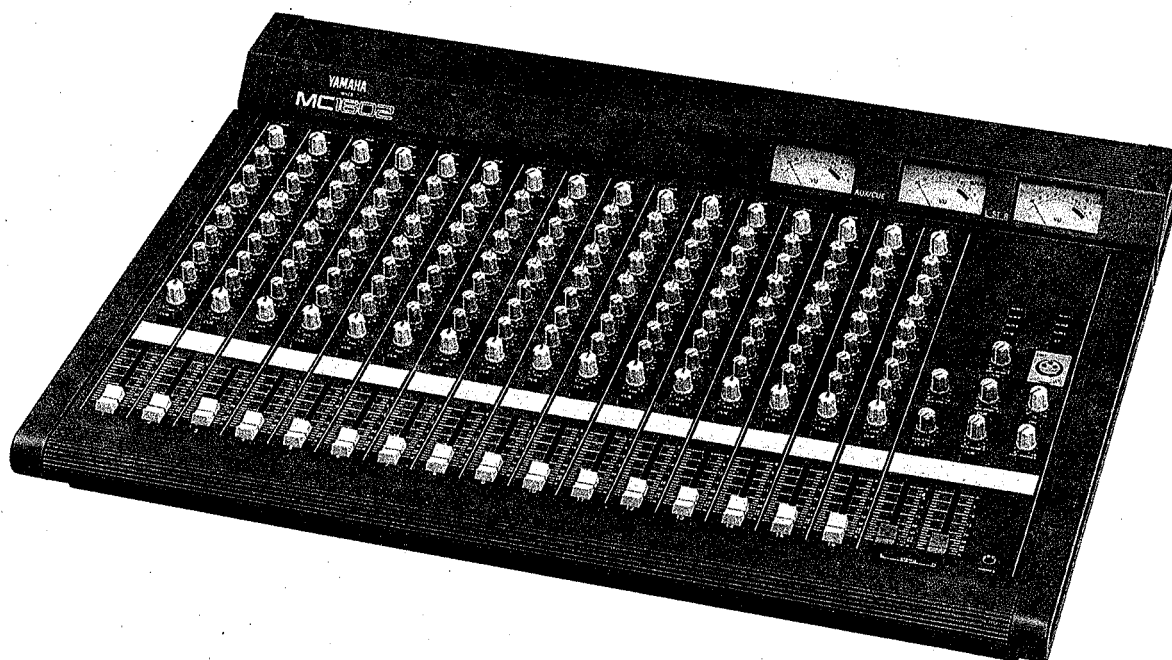

MC1602

Congratulations!

You are the proud owner of a Yamaha MC-series Mixing Console. Whether you chose the 8, 12 or 16-channel model, your Yamaha mixing console is a high-quality product that will give you superior performance in a wide range of applications. In addition to offering a versatile mixing system, the MC-series consoles offer electronically balanced inputs and stereo outputs to maintain optimum signal quality over long cable runs, a versatile 3-band equalizer with sweepable mid-frequency EQ on each input channel, three independent AUX submix systems for external effects routing or additional power amplifier feeds, cue switches for independent monitoring of all input channels and busses, and a built-in talkback system for convenient communication.

Of course, the MC-series mixing consoles also offer the high standard of quality and great sound that Yamaha is famous for. We urge you to read this operation manual thoroughly in order to make the most of the mixer's many features and controls.

CONTENTS

PRECAUTIONS	2
FRONT PANEL CONTROLS	3
Input Channels	3
Master Control Section	6
REAR PANEL CONNECTORS AND CONTROLS	9
APPLICATION EXAMPLE	11
BLOCK DIAGRAM	12
LEVEL DIAGRAM	13
DIMENSION CHART	13
SPECIFICATIONS	14
SERVICE	15

PRECAUTIONS

1. AVOID EXCESSIVE HEAT, HUMIDITY, DUST AND VIBRATION

Keep the unit away from locations where it is likely to be exposed to high temperatures or humidity—such as near radiators, stoves, etc. Also avoid locations which are subject to excessive dust accumulation or vibration which could cause mechanical damage.

2. AVOID PHYSICAL SHOCKS

Strong physical shocks to the unit can cause damage. Handle it with care.

3. DO NOT OPEN THE UNIT OR ATTEMPT REPAIRS OR MODIFICATIONS YOURSELF

This product contains no user-serviceable parts. Refer all maintenance to qualified Yamaha service personnel. Opening the unit and/or tampering with the internal circuitry will void the warranty.

4. MAKE SURE POWER IS OFF BEFORE MAKING OR REMOVING CONNECTIONS

Always turn the power OFF prior to connecting or disconnecting cables. This is important to prevent damage to the unit itself as well as other connected equipment.

5. HANDLE CABLES CAREFULLY

Always plug and unplug cables—including the AC cord—by gripping the connector, not the cord.

6. CLEAN WITH A SOFT DRY CLOTH

Never use solvents such as benzine or thinner to clean the unit. Wipe clean with a soft, dry cloth.

7. ALWAYS USE THE CORRECT POWER SOURCE

Make sure that the power source voltage specified on the rear panel matches your local AC mains supply.

U.S. & Canadian Models: 120V AC, 60Hz

General Model: 110 – 120/220 – 240 V AC, 50/60Hz

FRONT PANEL CONTROLS

Input Channels

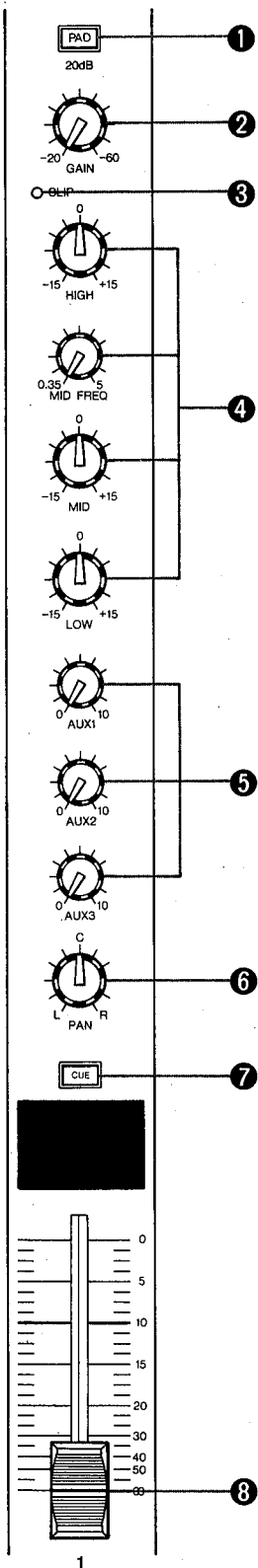

1 PAD Switch

This switch attenuates the signal applied to the corresponding rear-panel HI-Z or LO-Z input by 20 dB prior to the head amplifier and input gain control. The PAD switch effectively increases the range of input signal levels that can be handled by the mixer, preventing overloading of the input circuitry when receiving high-level signals.

2 GAIN Control

This control adjusts the input sensitivity of each input channel between -60 dB (0.775 mV) and -20 dB (77.5 mV) when the PAD switch is OFF (between -40 dB and 0 dB when the PAD switch is ON). Continuously variable gain control allows optimum matching with virtually any microphone or line source.

3 CLIP LED Indicator

The CLIP indicator LED lights when the post-EQ signal of the corresponding channel's input reaches a level 3 dB below the clipping level of the channel's circuitry. If the CLIP indicator lights more than only briefly on high-level transients it is necessary to decrease the input sensitivity of the channel using the GAIN control and PAD switch or, if this does not provide sufficient attenuation, to reduce the output level of the source connected to that channel's input.

4 3-band Equalizer

The equalizer section provided on each input channel comprises shelving LOW and HIGH controls, and a peaking MID control with a MID FREQ control that permits sweeping the midrange center frequency from 350 Hz to 5 kHz.

Control	Maximum Boost/Cut	Frequency	Type
HIGH	± 15 dB	10kHz	Shelving
MID	± 15 dB	0.35 ~ 5 kHz	Peaking
LOW	± 15 dB	100Hz	Shelving

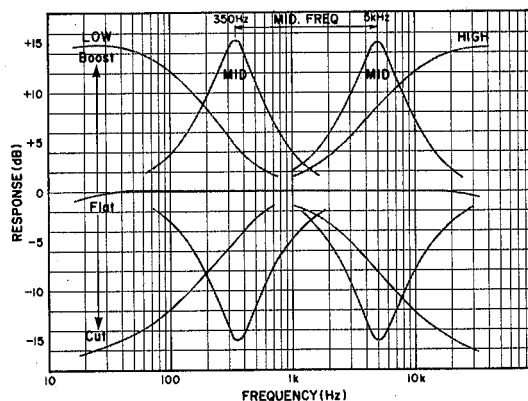

5 AUX Controls (1, 2 & 3)

The MC-series mixing consoles have three independent AUX busses which are fed by the corresponding AUX controls on the input channels. Each AUX control determines the level of the signal sent from that channel to the correspondingly numbered AUX mixing buss, which in turn feeds the correspondingly numbered AUX SEND control and AUX SEND jack on the console's rear panel. The AUX controls can be used to determine the amount of signal from the corresponding input channel sent to external effect devices or power amps fed by the AUX SEND jacks.

- * AUX 1 is factory pre-wired for pre-EQ/pre-fader operation, so the AUX 1 signal is not affected by the setting of the channel EQ controls or fader. An internal jumper allows the AUX 1 control to be rewired for post-EQ/post-fader operation.
- * AUX 2 and AUX 3 are factory pre-wired for post-EQ/post-fader operation, so the AUX 2 and AUX 3 signals are affected by the setting of the channel EQ controls and fader. Internal jumpers allow the AUX 1 control to be rewired for pre-EQ/pre-fader operation.
- * An internal POST EQ jumper allows the AUX controls to be further re-configured for post-EQ/pre-fader operation.
- * REFER THE ABOVE-MENTIONED REWIRING JOBS TO QUALIFIED YAMAHA SERVICE PERSONNEL!

6 PAN Pots

The PAN pot determines the position in the stereo sound field at which the sound from that channel is heard. Rotated fully counterclockwise the channel signal will be delivered from the left stereo output only, and will be heard at the far left of the sound field. If the PAN pot is turned fully clockwise, the sound from that channel will appear at the far right of the stereo sound field. If the PAN pot is set at its center position, the channel signal will be sent equally to both the left and right channels, causing the sound to appear at the center of the sound field. Intermediate PAN pot settings cause the sound to be heard at the corresponding position.

7 CUE Switch

When the CUE switch is pressed, the pre-EQ/pre-fader signal from that channel is fed to the PHONES output via the CUE/PHONES level control. The channel cue signal will be added to any other active cue signal. If you want to monitor only the signal from a single channel, make sure all other CUE switches are turned OFF.

8 Channel Fader

This is the main level control for each input channel. It determines the level of the signal sent from the corresponding input channel to the master stereo buss. The settings of the input channel faders determine the "mix" or balance of sound levels between the instruments or other sources connected to the inputs.

* If a channel is not being used, its fader should be set to the minimum position to prevent unwanted noise from being added to the main program signal.

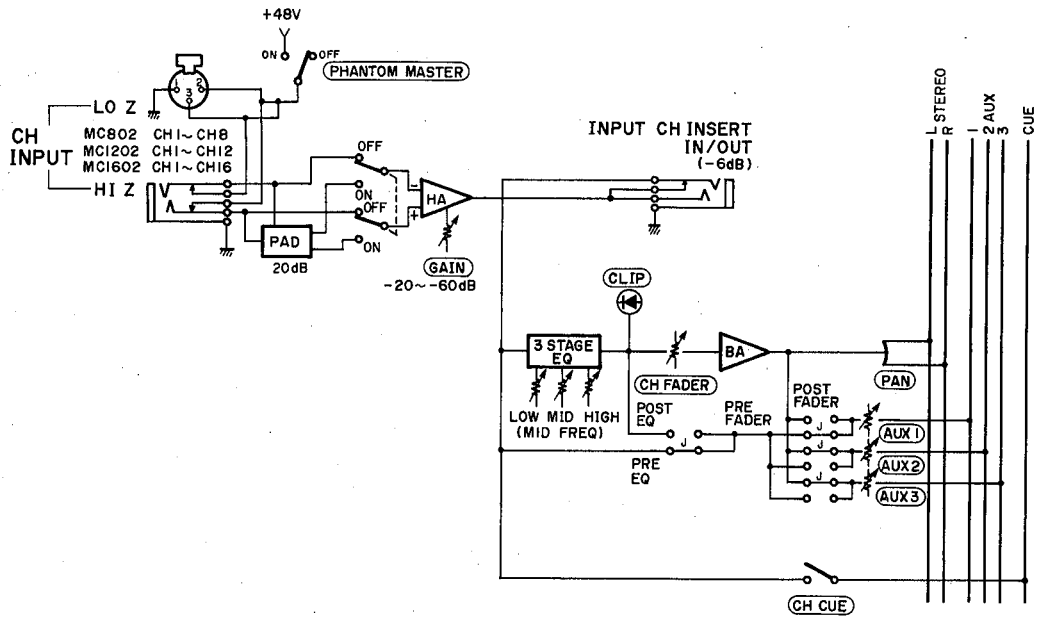

Master Control Section

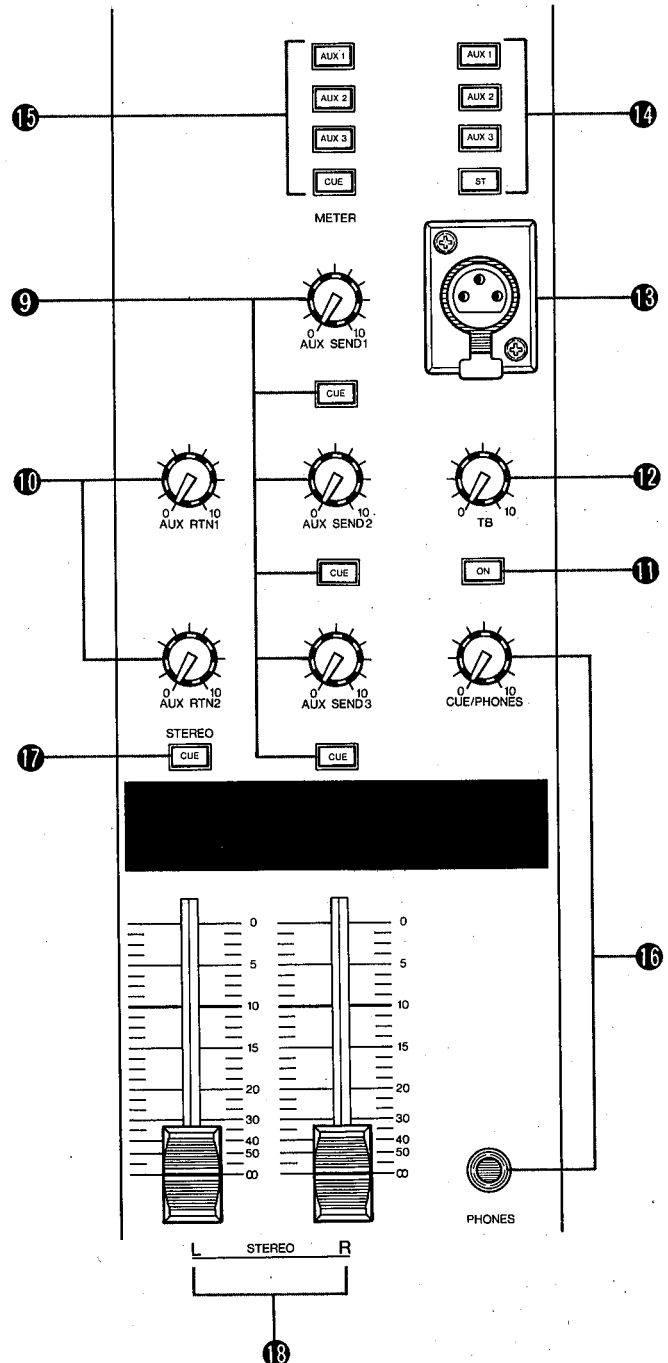
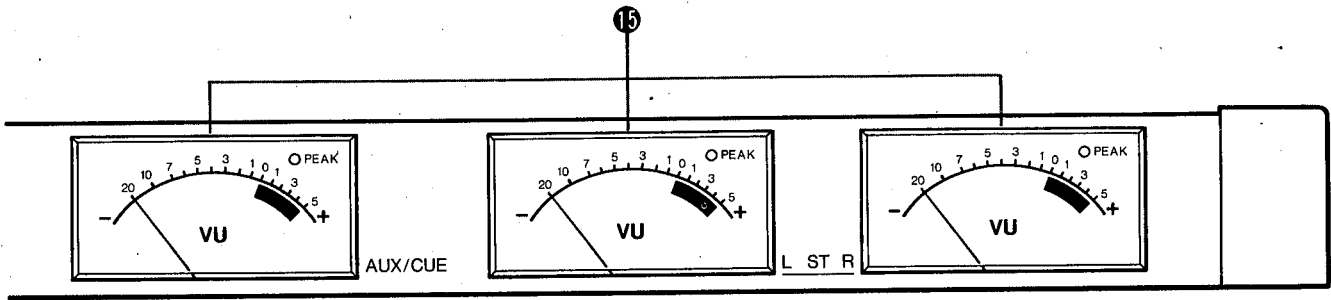

9 AUX SEND (1, 2 & 3) Controls & CUE Switches

These adjust the overall output level of the auxiliary "mixes" set up using the AUX 1, AUX 2 and AUX 3 controls on the input channels. AUX SEND 1 sets the overall level of the AUX 1 mix signal appearing at the AUX SEND 1 jack, AUX SEND 2 sets the overall level of the AUX 2 mix signal appearing at the AUX SEND 2 jack, and AUX SEND 3 sets the overall level of the AUX 3 mix appearing at the AUX SEND 3 jack. These controls should be used to optimally match the AUX SEND output level of the mixing console to the input sensitivity of the effect unit, signal processing device or amplifier used. The CUE switches associated with each AUX SEND control can be used to send the corresponding AUX SEND signal to the PHONES jack via the CUE/PHONES level control. The AUX cue signal will be added to any other active cue signal. If you want to monitor only the signal from a single AUX buss, make sure all other CUE switches are turned OFF.

10 AUX RTN 1 & AUX RTN 2 Controls

These controls adjust the level of the signal received at the rear-panel AUX RTN jacks and mixed into the main stereo program. Since stereo AUX returns are provided (AUX RTN 1 L & R, AUX RTN 2 L & R) the AUX RETURN controls simultaneously adjust the level of the signals appearing at the corresponding L and R return inputs. The returned L and R channel signals are sent to the L and R stereo buss lines. If only a single-channel signal is returned (i.e. a plug is inserted into only the L or R return jack), the signal will be fed to both the L and R channels of the stereo buss.

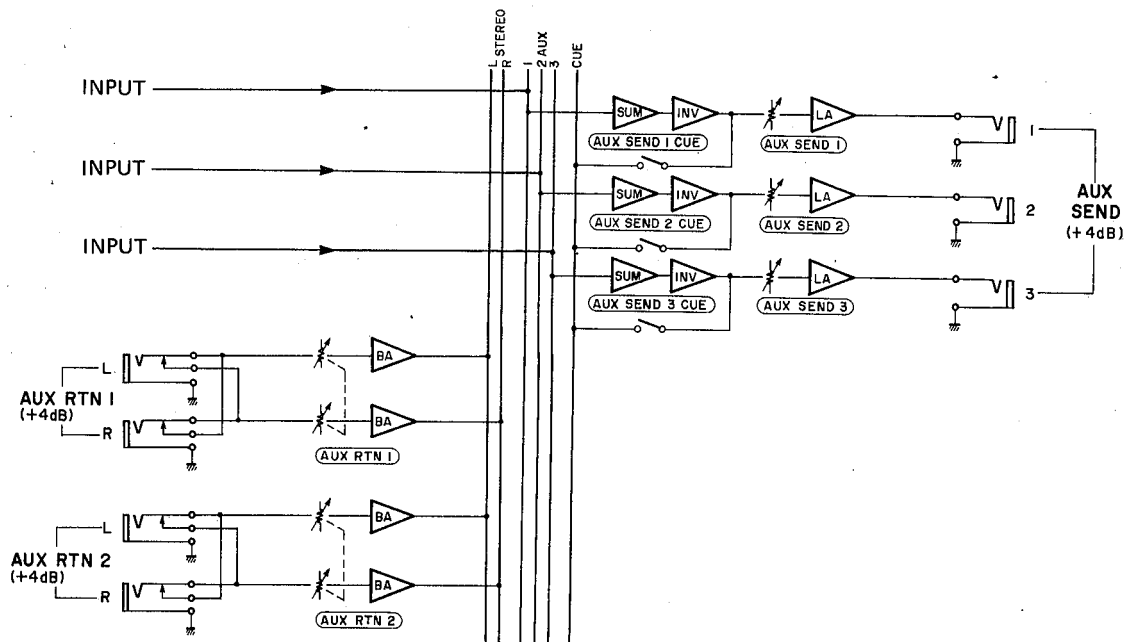

11 Talkback ON Switch

Pressing this switch activates the talkback microphone plugged into the talkback mic connector, allowing voice communication from the console operator to the STEREO, AUX 1, AUX 2 or AUX 3 busses according to the setting of the talkback assignment switches.

12 TB (Talkback) Level Control

Adjusts the level of the talkback signal sent to the selected buss.

13 Talkback Microphone Connector

This female XLR type connector accepts just about any standard 50 ~ 600 ohm microphone for talkback pickup. A gooseneck-type microphone that can be positioned for the most comfortable operation is an excellent choice.

14 Talkback Assignment Switches (AUX 1/AUX 2/AUX 3/ST)

These switches allow the talkback signal to be fed to the STEREO, AUX 1, AUX 2 or AUX 3 busses. Any number of switches may be ON at the same time, so you can "talk back" to a number of the console's busses at once.

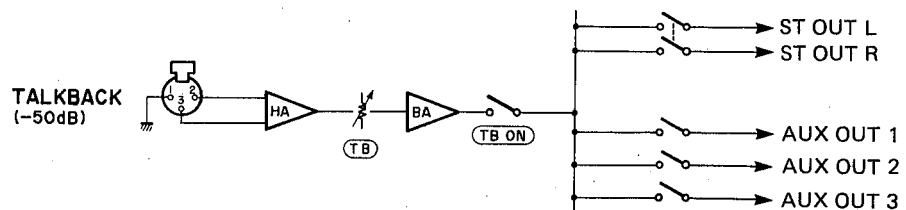

15 VU Meters and METER Assign Switches (AUX 1/AUX 2/AUX 3/CUE)

The MC-series mixing console feature three VU meters with built-in LED peak indicators for monitoring signal levels. The rightmost meter pair (L ST R) continuously monitors signals on the main stereo program buss. The AUX/CUE meter can be switched to monitor signals on the AUX 1, AUX 2, AUX 3 or CUE busses by pressing the corresponding METER assign switch.

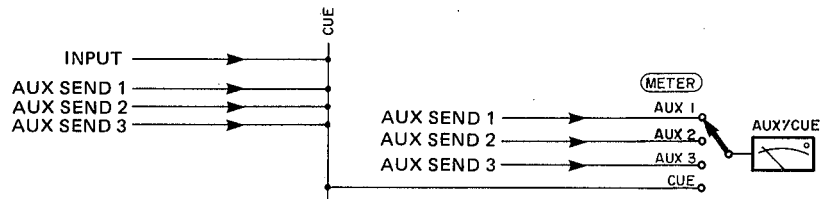

16 CUE/PHONES Control and PHONES Jack

The CUE/PHONES control adjusts the level of the cue signal sent to the PHONES jack so you can set the most comfortable headphone monitoring level. The stereo phone jack accepts any standard stereo headphones.

* The STEREO cue signal appears in stereo at the phones jack, while the channel and AUX cue signals are monaural.

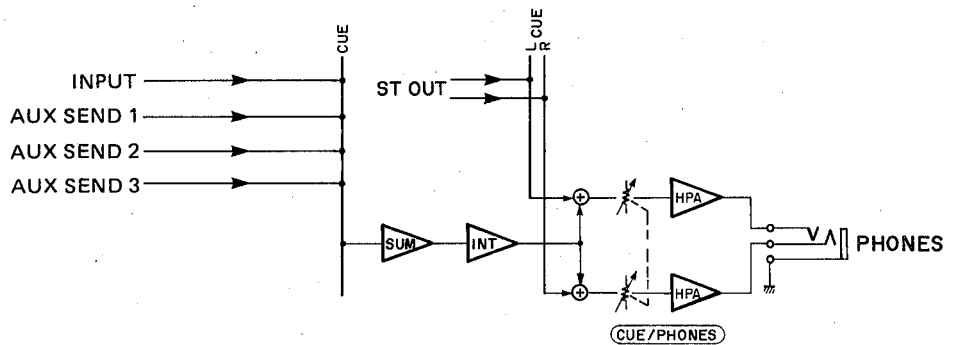

17 STEREO CUE Switch

Turning this switch ON sends the main stereo program buss signal, in stereo, to the stereo PHONES jack via the CUE/PHONES control. The STEREO CUE switch can normally be turned ON to permit headphone monitoring of the main stereo program, but it must be turned OFF to individually monitor input channel or AUX buss cue signals.

18 STEREO Master Faders

The STEREO master faders independently adjust the level of the left and right channel main stereo program buss signals appearing at the STEREO OUT connectors.

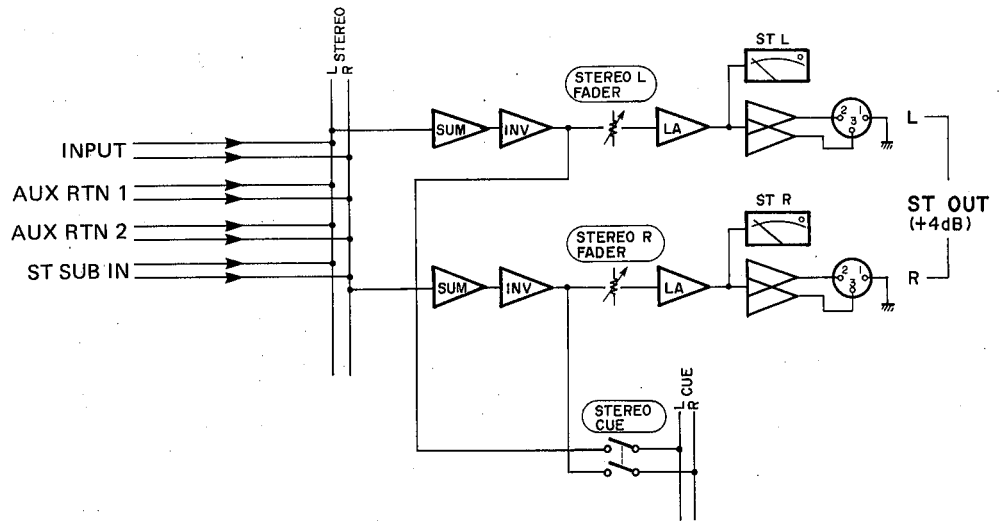

REAR PANEL CONNECTORS AND CONTROLS

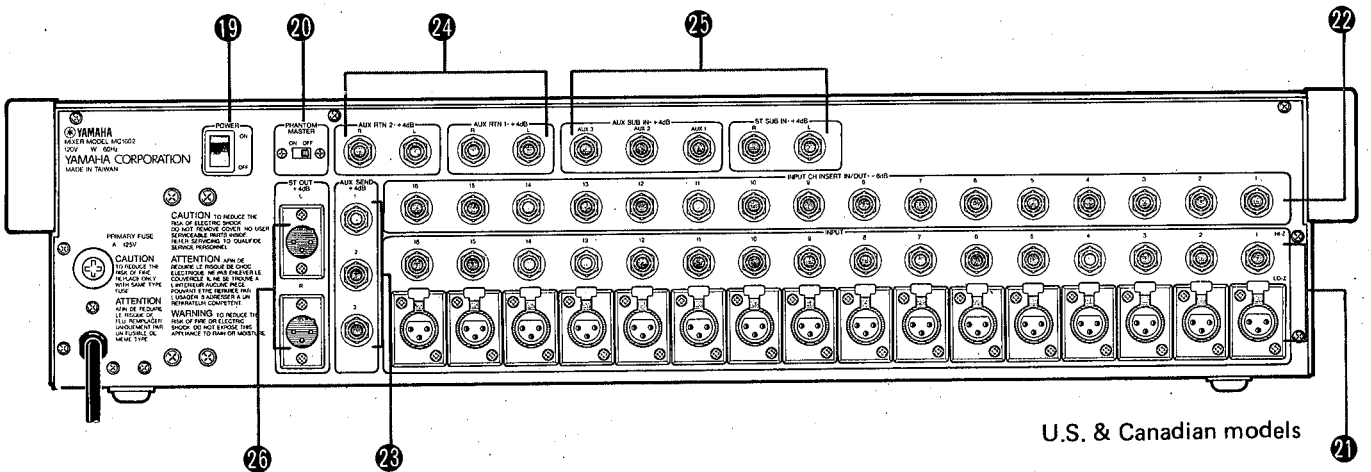

19 POWER Switch

Flip up to turn power ON, and down to turn power OFF. The VU meter lamps will light when the power is ON.

20 PHANTOM MASTER Switch

Turn this switch ON to apply +48 volts DC to the LO-Z XLR input connectors when using phantom-powered condenser microphones.

* NEVER turn the PHANTOM MASTER switch ON when applying line-sources to the LO-Z inputs.

21 HI-Z and LO-Z Input Connectors

Each input channel offers a choice of two input connectors: a balanced LO-Z (low-impedance) XLR-type connector and a HI-Z (high-impedance) tip-ring-sleeve 1/4" phone jack. The LO-Z inputs are primarily intended for use with professional low-impedance microphones or electronic instruments having low-impedance balanced outputs. The HI-Z inputs will accept either balanced or unbalanced signals from high-impedance microphones, musical instruments or other source equipment.

22 INPUT CH INSERT IN/OUT Jacks

These jacks permit inserting compressors, limiters or other types of external signal processing equipment between the head amplifier and EQ stage of each input channel. The jacks are tip-ring-sleeve types in which the tip is SEND (the output from the head amplifier), the ring is RETURN (the input to the EQ stage), and the sleeve is ground. External equipment may be inserted using "Y" cables which branch the SEND and RETURN lines from a tip-ring-sleeve phone plug to two separate mono phone plugs.

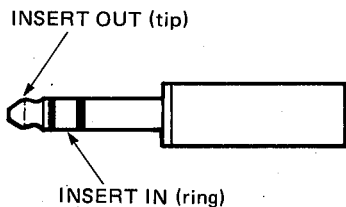

23 AUX SEND (1, 2 & 3) Jacks

These jacks deliver the AUX 1, AUX 2 and AUX 3 mixes, respectively, to feed an external effect device or power amplifier. Nominal output level/impedance is +4 dB/600 ohms.

24 AUX RETURN 1 (L & R) & AUX RETURN 2 (L & R) Jacks

The mono or stereo output from effect units fed by the AUX SEND jacks can be returned to the main stereo program mix via these jacks. Note that each AUX RETURN offers independent return inputs for the left and right busses, accommodating the return signal from effect units featuring stereo outputs. Nominal input level/impedance is +4 dB/600 ohms.

25 AUX SUB IN & ST SUB IN Jacks

These five jacks permit "cascading" two MC-series mixing consoles to increase the number of available input channels. The AUX OUT jacks from the first (slave) console should be connected to the corresponding AUX SUB IN jacks of the second (master) console, and the STEREO outputs from the slave console should be connected to the corresponding ST SUB IN jacks on the master console.

26 STEREO OUT L & R Connectors

The MC-series mixing consoles provide balanced XLR connector outputs from the main stereo buss. The signal delivered is a stereo mix of the input channel signals and the signals returned to the AUX RETURN jacks. The STEREO OUT signal will normally be used to drive a power amplifier and speaker system, powered keyboard speakers or a main house mixing console. Nominal output level/load impedance is +4 dB/600 ohms.

NOTE: The MC-series mixing console XLR connectors are wired according to DIN specifications. Pin 1 is shield (ground), pin 2 is hot (signal high) and pin 3 is cold (signal low).

APPLICATION EXAMPLE

In the system shown below the MC1602 is used as the main console in a sound reinforcement system. Three vocal microphones, six drum microphones, a microphone from the guitar amplifier and another from the bass amplifier are connected to 11 of the 16 available LO-Z inputs. The line-level stereo outputs from an on-stage keyboard mixer and the stereo outputs from an electronic percussion system are fed to four HI-Z inputs. A total of 15 input channels are thus used, leaving one free – just in case. The AUX 1 mix system feeds on-stage power amplifiers and monitor speakers for the

performers. The AUX 2 system is used to drive a digital reverb/effects unit to add ambience and effects where necessary. The AUX 3 system feeds a tape recorder to make a rough mono recording of the performance. The STEREO OUT connectors drive the main house power amplifiers and speaker system.

This is just one possible way of setting up the MC1602 for a sound reinforcement application. The actual setup you use will, naturally, be dictated by your own particular system requirements.

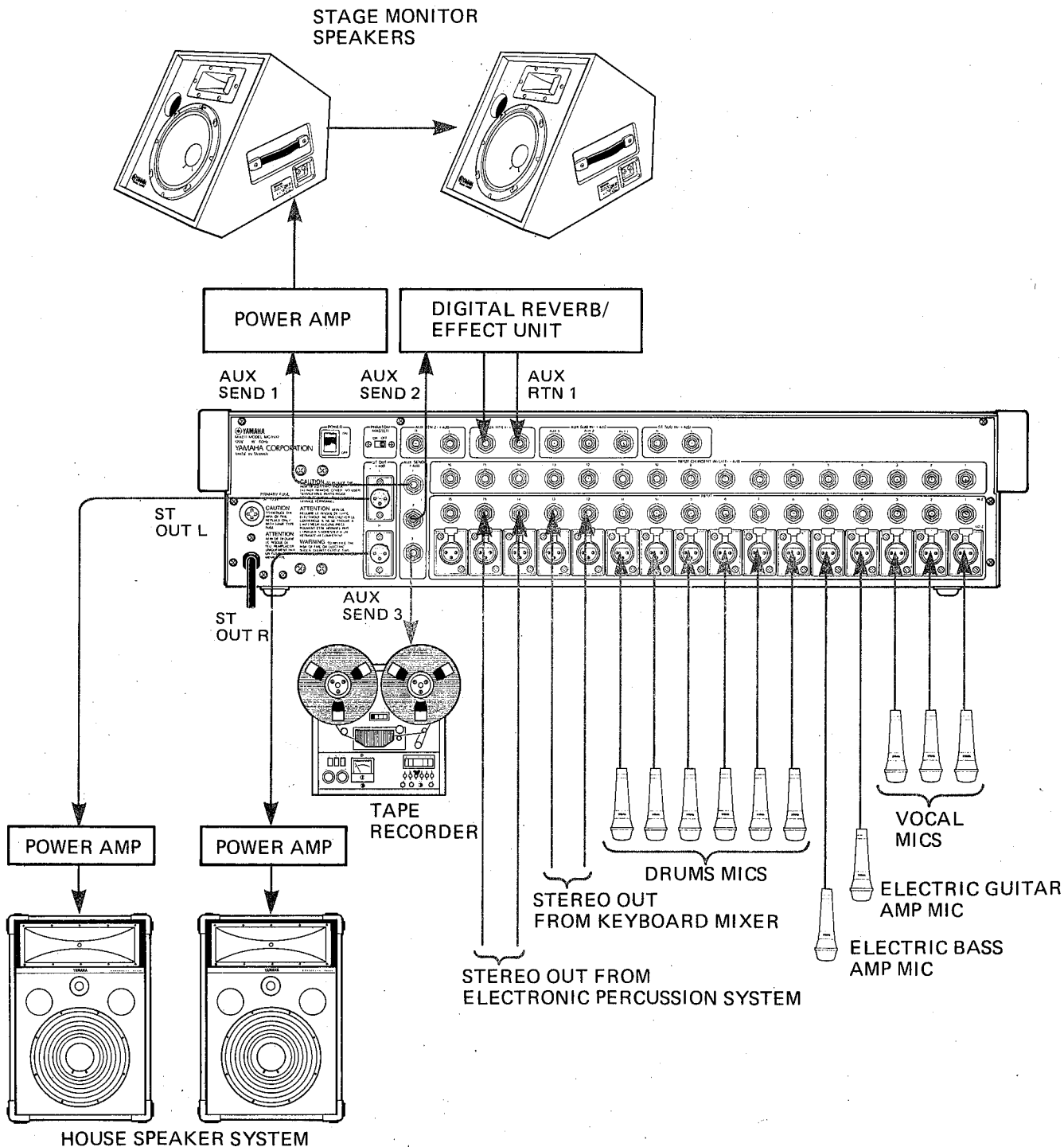

BLOCK DIAGRAM

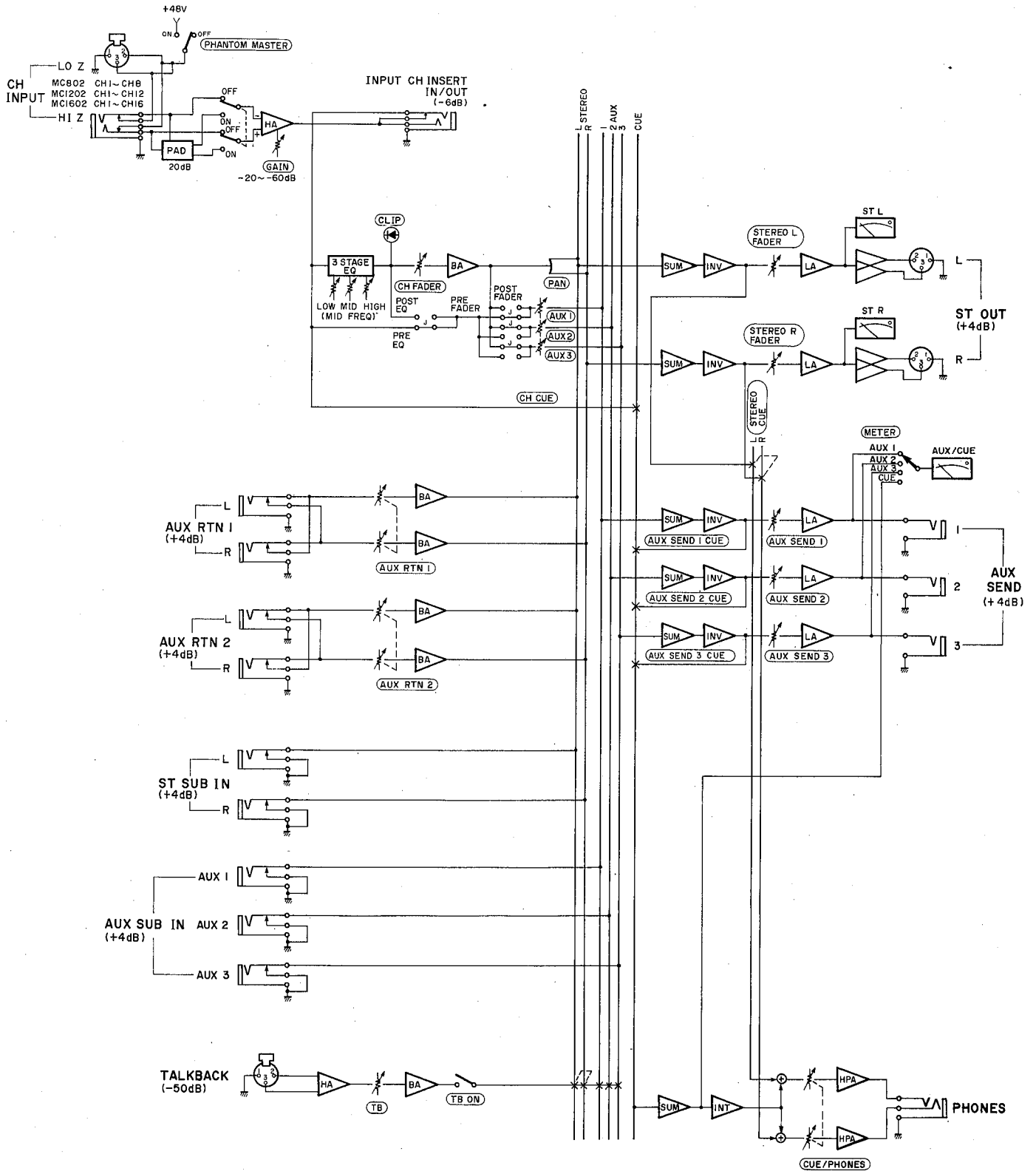

LEVEL DIAGRAM

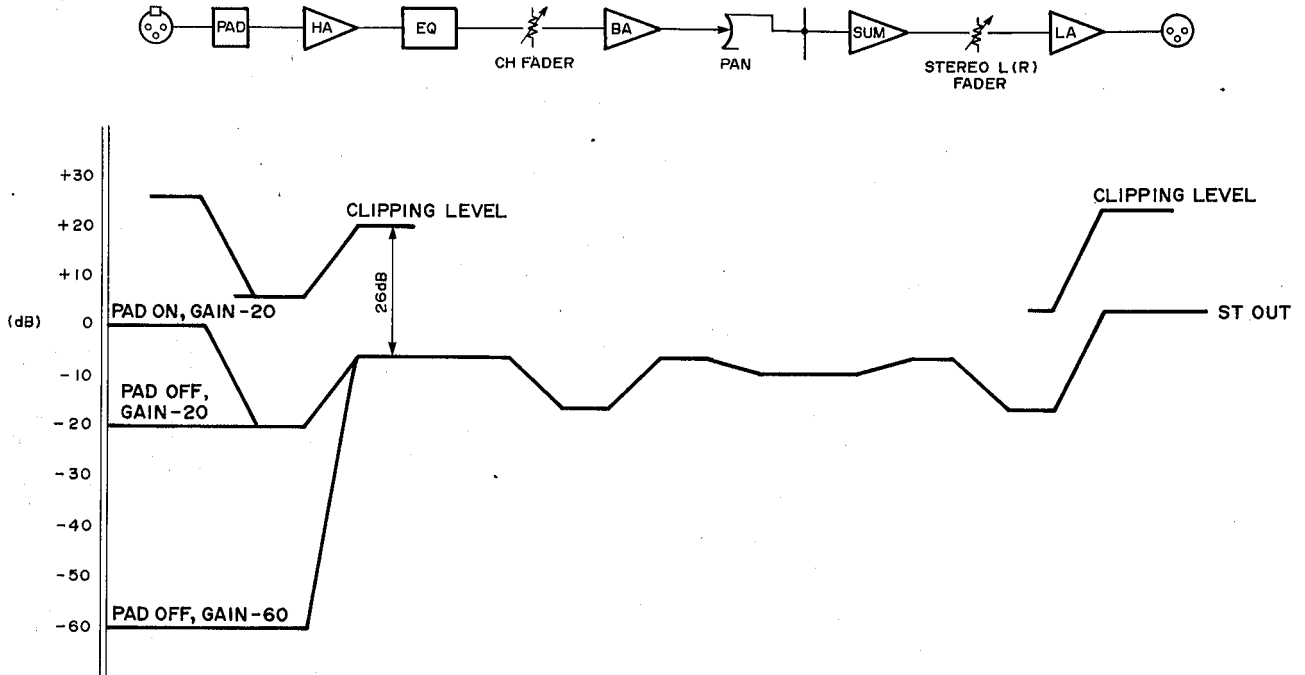

DIMENSION CHART

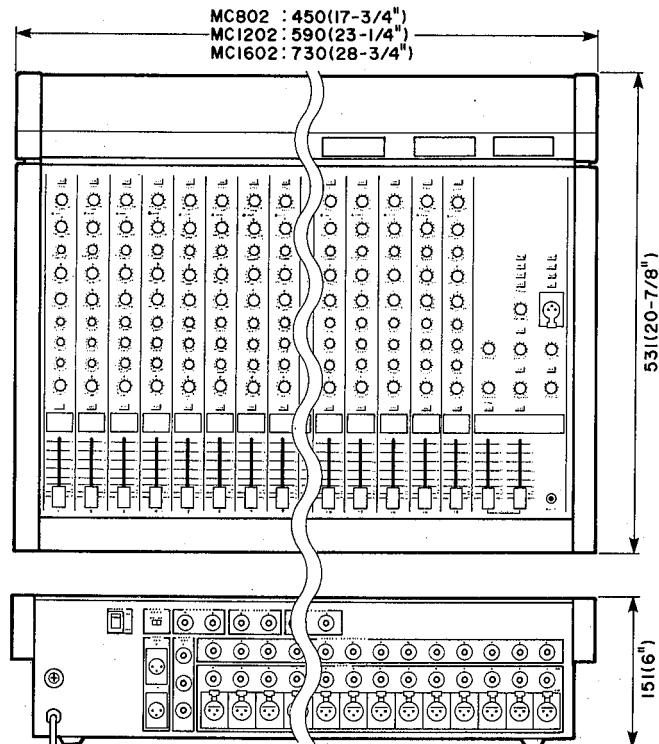

Unit: mm (Inch)

SPECIFICATIONS

Total Harmonic Distortion	Less than 0.1%, 20Hz – 20kHz @ +14dB into 600 ohms.
Frequency Response	+1, –3dB, 20Hz – 20kHz @ +4dB into 600 ohms
Hum and Noise* (20Hz – 20kHz, Rs=150 ohms, Input Gain max., Input Pad @ 0dB, Input Sensitivity –60dB)	<p>–128dB equivalent input noise.</p> <p>–90dB residual output noise (balanced outputs).</p> <p>–73dB at STEREO OUT with master fader at nominal level and all channel faders at minimum level.</p> <p>–64dB at STEREO OUT with master fader and one channel fader at nominal level</p> <p>–70dB at AUX SEND with AUX SEND level control at nominal level and all channel AUX controls at minimum level.</p> <p>–64dB at AUX SEND with AUX SEND and one AUX control at nominal level.</p>
Maximum Voltage Gain	<p>84dB CH IN to STEREO OUT</p> <p>84dB CH IN to AUX SEND 1</p> <p>94dB CH IN to AUX SEND 2, 3</p> <p>20dB AUX RETURN 1, 2 to STEREO OUT</p> <p>10dB SUB IN to AUX SEND 1 – 3</p> <p>10dB SUB IN to STEREO OUT</p>
Input Channel Gain Control	–20 ~ –60dB variation in gain, stop to stop.
Input Channel Pad Switch	0/20dB of attenuation.
Input Channel Equalization	<p>15dB maximum boost or cut in each of three bands.</p> <p>HIGH: 10kHz (shelving)</p> <p>MID: 350Hz – 5kHz (peaking)</p> <p>LOW: 100Hz (shelving)</p>
Crosstalk	<p>–60dB at 1 kHz, adjacent input channels.</p> <p>–60dB at 1 kHz, input to output.</p>
VU Meters (0 VU = +4dB Output)	<p>3 illuminated meters.</p> <p>STEREO L, STEREO R, AUX 1/AUX 2/AUX 3/CUE (switchable)</p>
Clip Indicators	RED LED built into each input channel. Lights when post-EQ channel signal is 3dB below clipping level.

Phantom Power

+48 VDC applied to electronically balanced inputs via 6.8 k-ohm limiting resistors. Master ON/OFF switch.

Power Requirements

U.S. & Canadian models: 120V AC, 60Hz
 General model: 110 – 120/220 – 240V AC, 50/60Hz

Power Consumption	MC1602: 60 watts
	MC1202: 50 watts
	MC802: 40 watts

Dimensions (W x H x D)

MC1602:	730 mm x 151 mm x 531 mm (28-3/4" x 6" x 20-7/8")
MC1202:	590 mm x 151 mm x 531 mm (23-1/4" x 6" x 20-7/8")
MC802:	450 mm x 151 mm x 531 mm (17-3/4" x 6" x 20-7/8")

Weight

MC1602:	18 kg. (39.7 lbs.)
MC1202:	15 kg. (33.1 lbs.)
MC802:	12 kg. (26.4 lbs.)

* Measured with a –6dB/octave LPF @ 12.7kHz.

● 0dB = 0.775Vr.m.s.

● Specifications subject to change without notice.

■ INPUT CHARACTERISTICS

INPUT			INPUT IMPEDANCE	SOURCE IMPEDANCE	SENSITIVITY**	INPUT LEVELS		CONNECTOR TYPE
PAD	GAIN	RATED LEVEL				MAXIMUM NON-CLIPPING LEVEL		
CH INPUT	OFF(0dB)	-60dB	LO-Z 4k ohms	50 ~ 600 ohms Microphones	-80dB (0.08mV)	-60dB (0.8mV)	-34dB (15.5mV)	XLR-3-31 type (Balanced) and Phone Jack (TRS) (Balanced)
		-20dB	HI-Z 10k ohms	600 ohms Lines	-40dB (7.75mV)	-20dB (77.5mV)	+6dB (1.55V)	
	ON(20dB)	-20dB (77.5mV)			0dB (775mV)	+26dB (15.5V)		
INPUT CH INSERT IN			10k ohms	600 ohms Lines	-26dB (38.8mV)	-6dB (388mV)	+20dB (7.75V)	Phone Jack (TRS) (Unbalanced)
ST SUB IN, AUX SUB IN			10k ohms	600 ohms Lines	-6dB (388mV)	+4dB (1.23V)	+20dB (7.75V)	Phone Jack (Unbalanced)
AUX RTN			10k ohms	600 ohms Lines	-16dB (123mV)	+4dB (1.23V)	—	Phone Jack (Unbalanced)
TALKBACK IN			4k ohms	50 ~ 600 ohms Microphones	-70dB (0.25mV)	-50dB (2.45mV)	-24dB (48.9mV)	XLR-3-31 type (Unbalanced)

■ OUTPUT CHARACTERISTICS

OUTPUT	OUTPUT IMPEDANCE	LOAD IMPEDANCE	OUTPUT LEVELS		CONNECTOR TYPE
			RATED LEVEL	MAXIMUM NON-CLIPPING LEVEL	
ST OUT	150 ohms	600 ohms Lines	+4dB (1.23V)	+24dB (12.3V)	XLR-3-32 type (Balanced)
AUX SEND 1 ~ 3	150 ohms	600 ohms Lines	+4dB (1.23V)	+20dB (7.75V)	Phone Jack (Unbalanced)
INPUT CH INSERT OUT	600 ohms	10k ohms Lines	-6dB (388mV)	+20dB (7.75V)	Phone Jack (TRS) (Unbalanced)
PHONES	100 ohms	8 ohms Phones	1mW	20mW	Stereo Phone Jack (Unbalanced)
		40 ohms Phones	3mW	130mW	

** Input level required to produce rated +4dB output level.

• 0dB = 0.775Vr.m.s.

SERVICE

This product is supported by Yamaha's worldwide network of factory trained and qualified dealer service personnel. In the event of a problem, contact your nearest Yamaha dealer.