



R Remote Version 4.5 User's Guide

Thank you for choosing a Yamaha product.

This user's guide explains setup, firmware update and use of "R Remote," a Windows/Mac application that lets you make parameter settings for the Rio3224-D/Rio1608-D/Ri8-D/Ro8-D/RSio64-D/RMio64-D/Rio3224-D2/Rio1608-D2 (subsequently "R series") and the Tio1608-D units.

This application lets you edit the parameters of up to twenty four devices from a single computer. Even if the device is not connected, you can mount it virtually and edit its settings beforehand.

Up to two computers in which R Remote is installed can be connected to a single device. This means, for example, that the main operator could operate a console such as the CL while two assistants make detailed adjustments at the other locations.



■ NOTICE

- Yamaha Corporation owns exclusive copyrights for the R Remote, the firmware for each device, and the user's guide.
- It is prohibited to duplicate or modify the firmware, software or manuals, in part or in their entirety, without permission from the copyright owner.
- The illustrations and screens as shown in this User's Guide are for instructional purposes, and may appear somewhat different from the screens which appear on your computer.
- This software was not produced with the intention to support touch-panel operation in Windows 8.1 / Windows 10, so we cannot guarantee operation if a touch-panel is used.
- Dante is a trademark of Audinate.
- Windows is a registered trademark of Microsoft @ Corporation in the United States and other countries.
- Mac and macOS are trademarks of Apple Inc., registered in the U.S. and other countries.
- The company names and product names in this document are the trademarks or registered trademarks of their respective companies.
- This guide predominantly uses screenshots of Windows. However, Mac screenshots are used when instructions of the function apply only to the Mac.
- This product incorporates open source software. For information about the software, refer to the "License Agreement," accessed from the "Legal" button on the "About R Remote" window.
- Software may be revised and updated without prior notice.

Contents

■ NOTICE	1
Using the PDF manual.....	4
System Requirements.....	4
Operation.....	4
Setup.....	5
Install (or uninstall) the R Remote.....	5
Set on the devices.....	6
UNIT ID	6
IP address	6
Connection	7
START UP MODE	8
Connect the computer and the devices.....	9
Power-on the devices.....	9
Specify the computer's IP address	10
For Windows.....	10
For Mac.....	12
Use Dante Controller or the CL/QL series console to specify the routing.....	12
Operating R Remote	13
Menu bar.....	13
Areas of the screen	14
Device Selection Area	15
Information Display Area	15
Main Area	16
Edit window	18
“Network Setup” dialog box	28
“Device Information” dialog box.....	29
“IP Address” dialog box	30
“Properties” dialog box.....	31
Updating the Firmware	32
Precautions.....	32
Updating – Operation Overview.....	32
Connecting the Computer to the Device.....	33
Network Settings.....	34
R Remote Firmware Updater	34
Update operation.....	36
Detecting the device	36
In case of failure in updating the firmware	36
Messages	39
■ Error messages.....	39
■ Warning Messages	39
■ Confirmation Messages	39

■ Other Messages.....	40
Troubleshooting.....	41
Decimal/hexadecimal conversion table	43

Using the PDF manual

- You can move to the corresponding page by clicking on links in the table of contents or in the text.
- If you want to find information on a specific topic, function or feature, select “Find” or “Search” from the Adobe Reader “Edit” menu and enter a key word to locate the related information anywhere in the document.
- You can also click on desired items and topics you want to refer to in the “Bookmarks” index to the left of the main display window, and jump to the corresponding page. (Click the “Bookmarks” tab to open the index if it is not displayed.)

System Requirements

In order to use R Remote, you'll need the following items.

- A computer equipped with the following conditions:

OS	Windows 7 SP1 Home Premium or later, Windows 8.1, Windows 10 (R Remote supports both 32-bit and 64-bit Windows.) OS X 10.9.5, OS X 10.10.x, OS X 10.11.x, macOS 10.12.x, macOS 10.13.x
CPU	Intel Core i3 or higher
HDD	120MB or more
Supported Devices (*)	Rio3224-D, Rio1608-D, Ri8-D, and Ro8-D (firmware V3.11 or later) RSio64-D (firmware V1.00 or later) RMio64-D (firmware V3.11 or later) Tio1608-D, Rio3224-D2, and Rio1608-D2 (firmware V1.00 or later)
Others	<ul style="list-style-type: none">• An Ethernet connector (1000BASE-T or higher recommended)• Ethernet cable (CAT5e or better)• Network switch (with gigabit Ethernet support), when connecting devices via a Dante network• Dante Controller must be installed. (**)

(*) When the firmware version of the target device is out-of-date and unsupported, you will need to update the firmware by using exclusive update software for each product.

(**) You can download Dante Controller from the download page of the following website.

<https://www.yamaha.com/proaudio/>

NOTE

The Minimum System Requirements described above are applied to the R Remote version 4.5.0. Keep in mind that the software is often updated and the system requirements are subject to change. You can check the latest version information of each program and its system requirements at the following website

<https://www.yamaha.com/proaudio/>

Operation

Keyboard Shortcuts

<Windows modifier key> (<Mac modifier key>) + <key> or click shows the shortcut keys. For example, <Ctrl> (<command>) +click means “press <Ctrl> under Windows or <command> under Mac, then click.”

Right Click

On Mac click while holding down the <control> key.

Setup

The setup workflow is shown below.

1 [Install the R Remote](#)



2 [Set on the devices](#)



3 [Connect the computer and the devices](#)

NOTE

You cannot control the parameters of the device connected from another subnet via DANTE DOMAIN MANAGER.



4 [Power-on the devices](#)



5 [Specify the computer's IP address](#)



6 [Use Dante Controller or the CL/QL series console to specify the routing](#)

For details on connections and settings for the devices, refer also to the owner's manual of your devices.

Install (or uninstall) the R Remote

The installation procedure is as follows.

1. Logon to Windows or Login to Mac with administrator account.
2. After decompressing the downloaded file, double-click "setup.exe" (Windows) or "Install R Remote Vxxx.pkg" (Mac)(xxx is version) in the decompressed file location.
The R Remote setup wizard will appear.

NOTE

Under Windows, the "User Account Control" dialog box may appear. Click [Continue] or [Yes].

3. Proceed with the installation as directed by the instructions in the screen.

To uninstall the software (remove the application),

Windows:

In [Control Panel](#), click [Programs and functions] or [Uninstall a program], then select the item you want to uninstall, and click [Uninstall or change].

A dialog box will appear; follow the instructions in the screen to uninstall the software.

If the "User Account Control" dialog box appears, click [Continue] or [Yes].

Mac:



Double-click "Uninstall R Remote.app" which is included in the installer.

Set on the devices

Set the DIP switches and [UNIT ID] rotary switch of the unit, taking note of the following settings. On the Rio3224-D2 and Rio1608-D2, set the following settings using the front panel display of the device.

UNIT ID





- Set a unique UNIT ID that will not conflict with the other device, over a range of 1 to 24 (hexadecimal 18). R Remote will not detect units with a setting of 0 or 25 or higher. (For details on converting between decimal and hexadecimal, refer to the "[Decimal/hexadecimal conversion table](#)" on page 43)
- Rio3224-D2 and Rio1608-D2: Set the "UNIT ID" on the SETUP menu.
- For devices excepting the Rio3224-D2 and Rio1608-D2: Set the DIP switches to the following combinations.

Settings	Switch
UNIT ID ranging from 1 to F (decimal values 1 to 15)	 1 (1 up)
UNIT ID ranging from 10 to 18 (decimal values 16 to 24)	 1 (1 down)

IP address

Specify the IP address that the R Remote uses for control.
(The IP address set here is different from the IP address of the Dante network.)

For devices other than the Tio1608-D, the RMio64-D, the Rio3224-D2 and the Rio1608-D2

Settings	Switch
Auto IP (The IP address will be automatically set to 169.254.xxx.xxx.)	 2 3 (2 and 3 up)
DHCP (The IP address assigned by the DHCP server will be used.)	 2 3 (2 down, 3 up)
Static IP (Auto) [The IP address will be set to 192.168.0.xxx (xxx= UNIT ID).]	 2 3 (2 up, 3 down)
Static IP (Manual) (Set the IP address to the value specified on the R Remote)	 2 3 (2 and 3 down)

The first time that you connect an R series unit to your computer, set this to something other than Static IP (Manual). If you want to use the Static IP (Manual) setting, first specify the IP address on the R Remote and then switch to Static IP (Manual).





NOTE

If the network consists only of Dante devices and R Remote, we recommend that you use the Auto IP setting.

If you are connecting to an existing network, select DHCP as needed.

If you want to use zoning to set the IP address, or want to connect to an existing network but use a static IP address, choose Static IP (Manual) and use the R Remote to set the IP address.

Tio1608-D

Settings	Switch
Auto IP (Link Local) (The IP address will be automatically sets to 169.254.xxx.xxx.)	 $\frac{5}{6}$ (5 and 6 up)
DHCP (The IP address assigned by the DHCP server will be used.)	 $\frac{5}{6}$ (5 up, 6 down)
Static IP (Auto) [The IP address will be set to 192.168.0.xxx (xxx= UNIT ID).]	 $\frac{5}{6}$ (5 down, 6 up)
Static IP (Manual) (Set the IP address to the value specified on the R Remote)	 $\frac{5}{6}$ (5 and 6 down)

RMio64-D



The IP address is set by using the R Remote since RMio64-D has no DIP switches for setting the IP address. Refer to the ["IP Address" dialog box](#) for more information.

Rio3224-D2-D and Rio1608-D2



Set the "NETWORK MODE" in the SETUP menu.

Connection

For devices other than the RMio64-D, the Rio3224-D2 and the Rio1608-D2

Settings	Switch
DAISY CHAIN	 $\frac{4}{4}$ (4 up)
REDUNDANT	 $\frac{4}{4}$ (4 down)

RMio64-D

Settings	Switch
DAISY CHAIN	 $\frac{1}{1}$ (1 up)
REDUNDANT	 $\frac{1}{1}$ (1 down)

Rio3224-D2-D and Rio1608-D2



Set the "SECONDARY PORT" in the SETUP menu.

START UP MODE



NOTE

If a CL/QL series unit is not connected, we recommend that you set START UP MODE to RESUME. If this is set to REFRESH, settings must be transmitted from the R Remote each time the R series unit is restarted.

Rio3224-D, Rio1608-D, Ri8-D and Tio1608-D

Settings	Switch
<p>REFRESH</p> <p>When the device is turned on, the following settings are initialized and inputs/outputs are muted.</p> <ul style="list-style-type: none"> • HA GAIN (-6 dB) • +48V (OFF) • HPF (OFF) • HPF FREQ (80Hz) • Gain Compensation (OFF) (Except for Tio1608-D) <p>NOTE To use the device after initialization, you need to: turn the device off → set the DIP switches to RESUME → turn the device on.</p>	 <p>(7 and 8 up)</p>
<p>RESUME</p> <p>(The unit starts up using the settings assigned prior to the most recent power off.)</p>	 <p>(7 down, 8 up)</p>

RSio64-D

Settings	Switch
<p>NORMAL</p> <p>(Start up normally with the settings of the previous start-up.)</p>	 <p>(7 and 8 up)</p>
<p>INITIALIZE</p> <p>The following settings are initialized when the device is turned on.</p> <ul style="list-style-type: none"> • SLOT 1-4 SRC (OFF) • WORD CLOCK SELECT (DANTE/48kHz) • USER PATTERN (same routing configuration as the preset PATTERN # 1) • Static IP (Manual) (0.0.0.0) • PANEL LOCK (Unlock) • Dante PATCH (All OFF) • Dante DEVICE LABEL (Y001-Yamaha-RSio64-D-123456) (*1) <p>NOTE To use the device after initialization, you need to: turn the device off → set the DIP switches to NORMAL → turn the device on.</p>	 <p>(7 down, 8 up)</p>

(*1) The third and fourth characters of the Dante DEVICE LABEL depend on the device settings of DIP switch 1 and the SETUP [UNIT ID] rotary switch. The lower six digits depend on the lower six digits of the unit's MAC address.

Rio3224-D2-D and Rio1608-D2

Set the "START UP MODE" in the SETUP menu.

Settings

REFRESH

When the device is turned on, the following settings are initialized and inputs/outputs are muted.

- HA GAIN (-6 dB)
 - +48V (OFF)
 - HPF (OFF)
 - HPF FREQ (80Hz)
 - GAIN COMPENSATION (OFF)
 - COMPENSATION GAIN (-6 dB)
-

RESUME

(The unit starts up using the settings assigned prior to the most recent power off.)

REFRESH w/o MUTE

(The settings are initialized when turned the device on. The initial values are the same as for REFRESH. However, inputs and outputs are not muted.)

Connect the computer and the devices

Use an Ethernet cable to connect the computer and the devices.

If you selected DAISY CHAIN in "SECONDARY PORT" on the above, connect the Dante connectors of the devices in a daisy chain to the computer.

If you selected REDUNDANT in "SECONDARY PORT" on the above, connect the computer to the network switch that is connected to the Dante [PRIMARY] connector.

NOTE

You cannot control the parameters of the device connected from another subnet via DANTE DOMAIN MANAGER.

Power-on the devices

Power-on the devices. The DIP switch settings, the rotary switch settings and the settings in the SETUP menu after power-on will not be applied until the next power-on.

Specify the computer's IP address

Specify the computer's IP address so that it can communicate with the devices.

The method of making this setting depends on whether you're using Windows or Mac. Also, the computer's IP address setting will differ depending on the IP address specified in "[Set on the devices.](#)"

If you're using Mac, click the [link](#).

For Windows

Accessing the Control Panel

The way to access the Control Panel will depend on your operating system.

* Windows 7

Select [Start] → [Control Panel].

* Windows 8.1/Windows 10

Right click [Start] → [Control Panel].

TCP/IP Settings

Make TCP/IP settings for the computer as follows.

1. Access the Control Panel, then click or double-click [Network and Sharing Center] or [View network status and tasks].

The "Network and Sharing Center" is displayed.

2. Click [Manage network connection] or [Change adapter settings] from the "Tasks" list located in the left side of "Network and Sharing Center" window, then double-click [Local Area Connection].

The "Local Area Connection Status" dialog box will be displayed.

NOTE

- The "User Account Control" dialog box may appear. Click [Continue] or [Yes].
- If the "Local Area Connection properties" dialog box appears, skip ahead to step 4.

3. Click [Properties].

The "Local Area Connection properties" dialog box will be displayed.

NOTE

The "User Account Control" dialog box may appear. Click [Continue] or [Yes].

4. Select [Internet Protocol Version 4(TCP/IPv4)], then click [Properties].

The "Internet Protocol Version 4(TCP/IPv4) Protocol" dialog box will be displayed.

5. Make the following settings according to the IP address setting you made in "[Set on the devices.](#)"

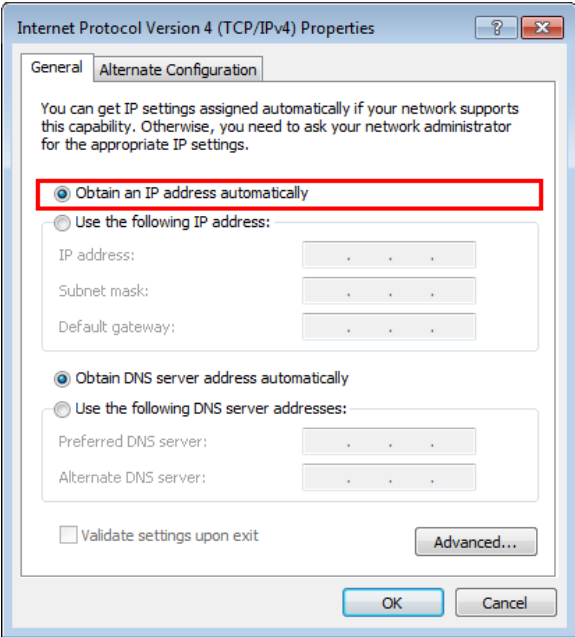
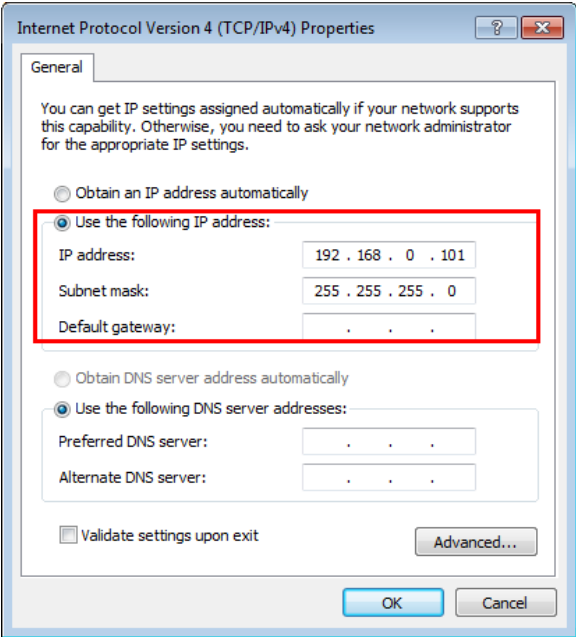
Auto IP or DHCP	Static IP (Auto)
Click [Obtain an IP address automatically].	Click [Use the following IP address:]. As the IP address, enter "192.168.0.xxx (a value in the range 1 to 254 that does not conflict with any other device, including the target devices), and enter "255.255.255.0" as the subnet mask. The 192.168.0.101 shown below is an example.
	

If you're using Static IP (Manual), specify the setting that's appropriate for your network. For details, consult your network administrator.

6. Click [OK].

Proceed to "[Use Dante Controller or the CL/QL series console to specify the routing.](#)"

For Mac

Make TCP/IP settings for the computer as follows.

1. Click [System Preferences]→[Network].
The "Network" dialog box will be displayed.
2. Click the service that you want to connect to the device.
If you're using the Ethernet port that's built into the Mac, click [Ethernet].
3. Make the following settings according to the IP address setting you made in "[Set on the devices](#)"

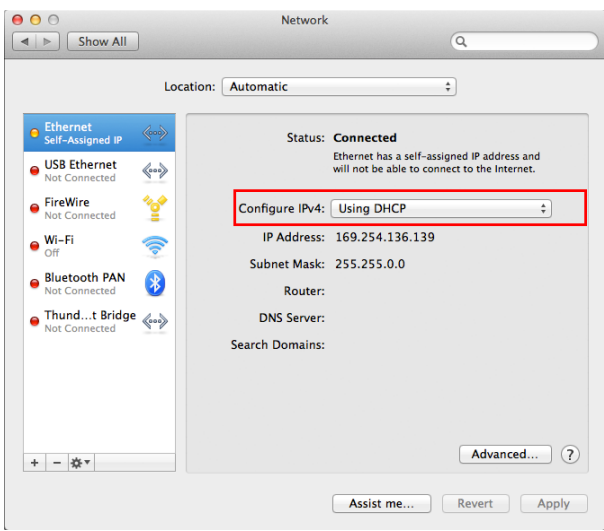
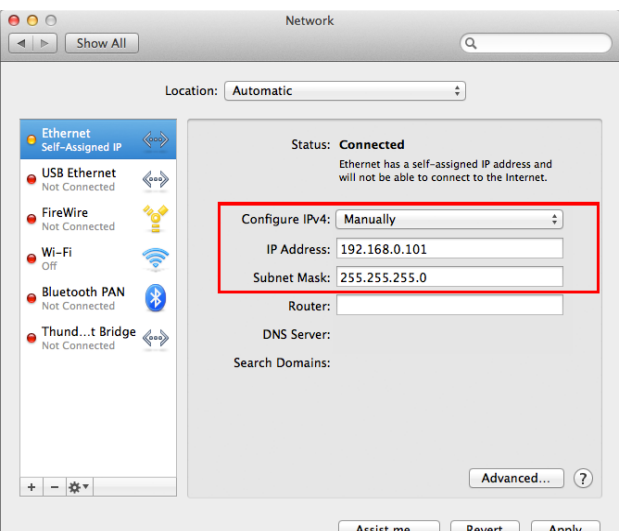
Auto IP or DHCP	Static IP (Auto)
In "Configure IPv4," choose [Using DHCP].	In "Configure IPv4," choose [Manually]. As the IP address, enter "192.168.0.xxx (a value in the range 1 to 254 that does not conflict with any other device, including the target devices), and enter "255.255.255.0" as the subnet mask. The 192.168.0.101 shown below is an example.
	

If you're using Static IP (Manual), specify the setting that's appropriate for your network. For details, consult your network administrator.

4. Click [Apply] button, then close "Network" dialog box.

Use Dante Controller or the CL/QL series console to specify the routing

If you're using Dante Controller to specify the routing, refer to "Dante Controller User's Guide."
If you're using a CL/QL series console to specify the routing, refer to the each Reference Manual.

This completes the setup.

Operating R Remote

Start R Remote.

Windows 7/Windows 10 users: click [Start]→[All Programs]→[Yamaha R Remote]→[R Remote]

Windows 8.1 users: in the "Start screen," double-click the [R Remote] tile.

Mac users: click [Go]→[Applications]→ double-click [R Remote].

NOTE

- When you start R Remote, the ["Network Setup" dialog box](#) may appear, allowing you to select the computer's network card that will be used for communication with the devices. If this appears, click the network card that is connected to the device, and then click the [Apply] button.
- For R Remote for Windows 8.1, depending upon user access privileges, the software's "Tile(icon)" may not appear on the "Start screen". In such cases, you can find the software icon in "Apps" by the following steps:

1. Right-click anywhere on Start screen.
2. Click "All apps" button at the bottom right side of Start screen.

Menu bar

The commands that can be executed by R Remote can be found here, grouped by category.

Click here to see a list of commands.

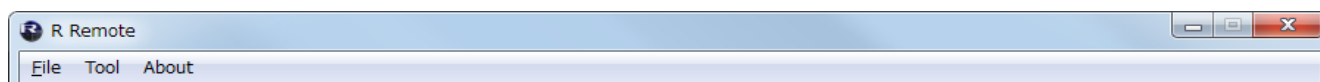

Menu	Command	Summary	Dialog box that appears
[File]	[Open]	Opens a previously-saved file (rrmt format or rrm format). NOTICE If you open the file when devices are connected, the settings will be applied to the devices. Be aware that if a CL/QL series console is also connected, its settings will be overwritten.	"Open File" dialog box
	[Save As]	Saves the file. It will have a file name extension of rrmt, and will be usable only by R Remote.	"Save File" dialog box
	[Network Setup]	Selects the computer's network adapter that will be used to communicate with the devices.	"Network Setup" dialog box
	[Device Information]	Displays information about the devices that are connected.	"Device Information" dialog box
	[Quit] *1	Quits R Remote.	---
[Tool]	[Firmware Update]	Calls up the window to update the firmware.	R Remote Firmware Updater
[About] *1	[About R Remote]	Displays details such as the software version of R Remote.	"About R Remote" dialog box

*1 Mac users: [Quit] and [About] are located in the R Remote menu.

Areas of the screen

The R Remote screen is broadly divided into three areas: the Device Selection Area, the Information Display Area, and the Main Area.

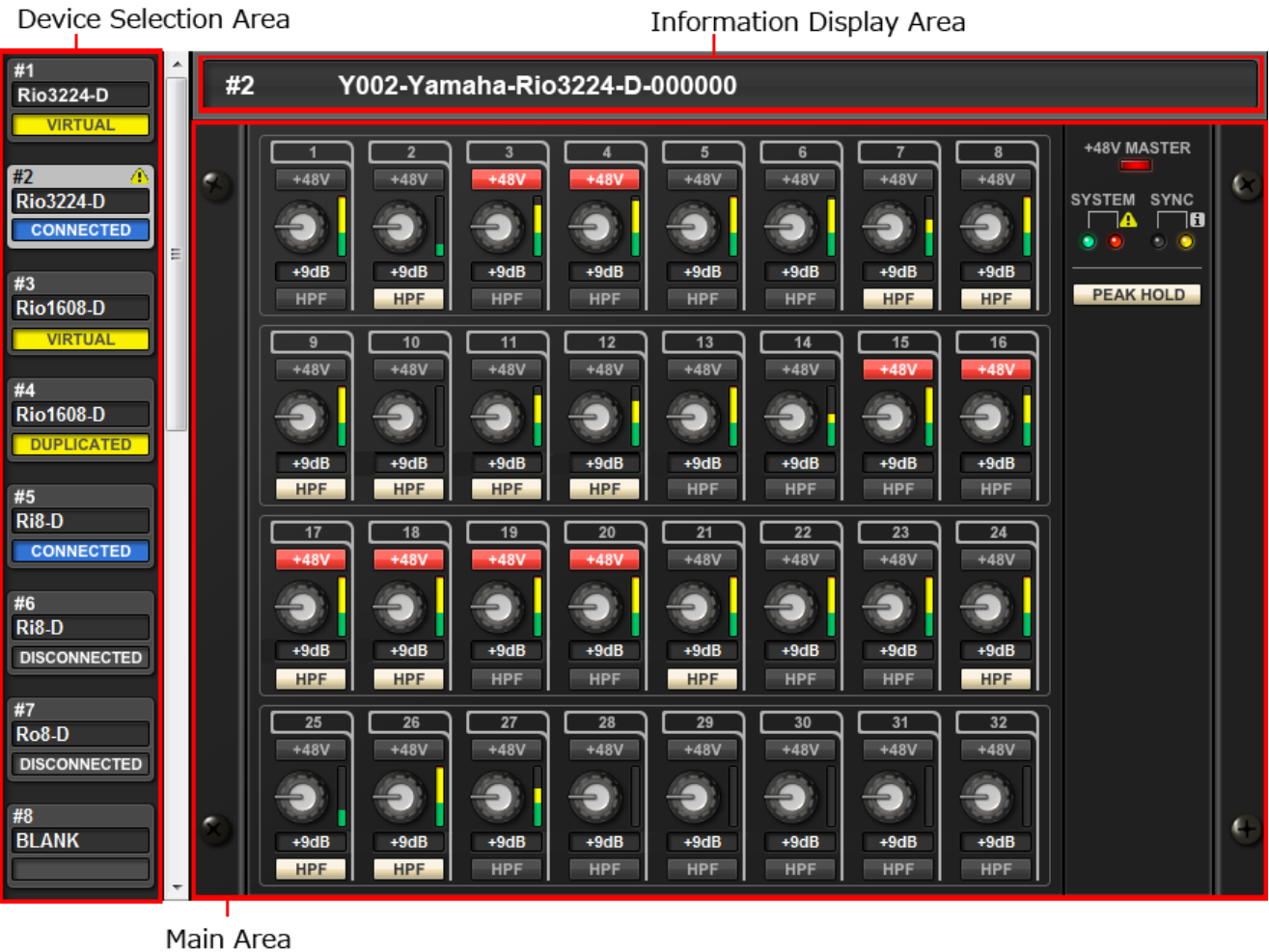

Device Selection Area



When you click a display switching button, the corresponding device is shown in the information display area and in the main area.

With a display switching button selected, pressing the left mouse button makes all indicators of the corresponding device blink, allowing you to identify the corresponding unit.

Also shows an attention icon  depending on the device status.

When you right-click a display switching button, the following context menu appears.

Command	Summary
[Mount]	Opens the "Mount" window. Select the device that you want to mount.
[Connect]	Synchronizes with the selected device.
[Disconnect]	Disconnects from the selected device.
[Properties]	Open the " Properties " dialog box.
[Summary] (Rio3224-D2 and Rio1608-D2 only)	Displays the selected device summary (REPORT).
[Log] (Rio3224-D2 and Rio1608-D2 only)	Save the device log. The file is named automatically according the following format. In case of Rio3224-D2: Rio3224-D2_201712261339.log * The numbers after “_” indicate the year, month, day and time.

The connection status is shown below each display switching button.

Indication	Status
VIRTUAL	The device is mounted without the existence of the actual device. Alternately, communication is impossible due to incorrect settings having been made.
BLANK	The device is not powered-on or the device is not connected to the computer.
CONNECTED	Currently synchronized with the device.
DISCONNECTED	Synchronization with the device is possible, but is currently disconnected by the [Disconnect] command. Alternatively, communication has been interrupted, or connection failed.
DUPLICATED	More than one device of the same UNIT ID exists. Eliminate any UNIT ID conflict between devices.

Information Display Area

This area shows the UNIT ID and name of the selected device.

To check the firmware version or IP address, choose [File] menu -> [Device Information] to open the "[Device Information](#)" dialog box.

Main Area

This area shows the state of the selected device and allows basic parameter editing. The display depends on the model.

For Rio3224-D / Rio1608-D / Ri8-D / Tio1608-D / Rio3224-D2 / Rio1608-D2

The screen is explained here using the Rio3224-D as an example. The number of items in the HA display area differs depending on the model.

The [Edit window](#) opens if you double-click or right-click and choose [Open Edit Window] anywhere other than on a controller.

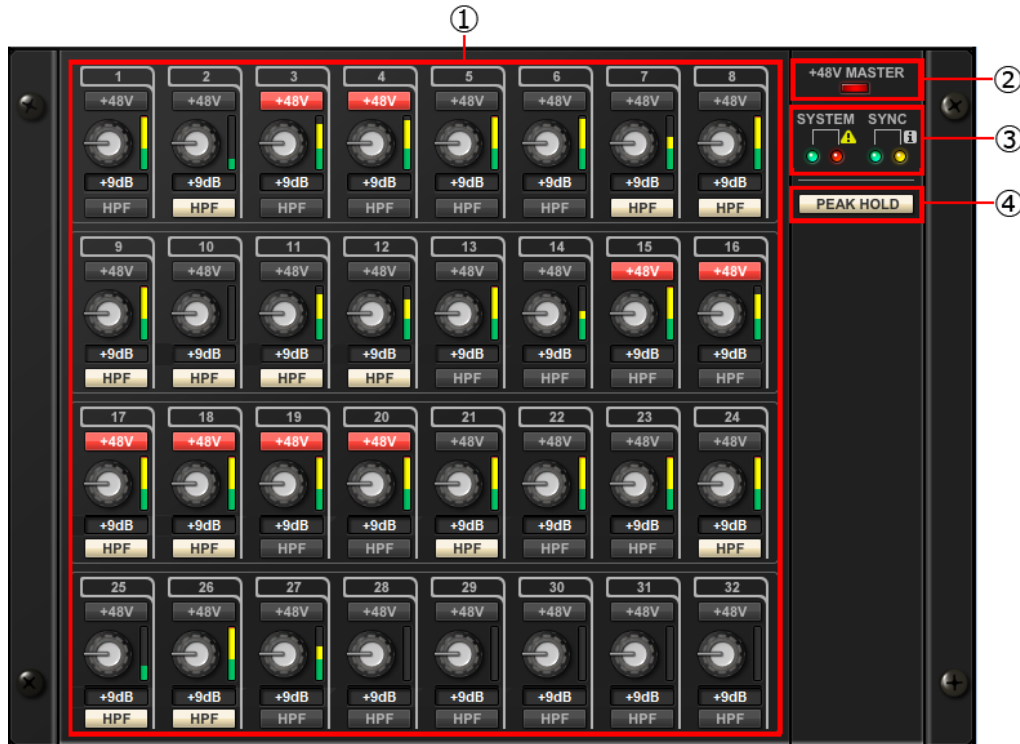

① HA display area

Here you can view and edit HA settings for the Rio3224-D / Rio1608-D / Ri8-D / Tio1608-D / Rio3224-D2 / Rio1608-D2 unit.

If you press the left mouse button on an area that shows the device's jack number, the indicator of the actual device's corresponding jack will light.



a. [+48V] button

Turns phantom power on/off for each channel.

b. GAIN knob

Specifies the analog gain for the HA of the device. The current setting is shown in the numeric box located below the knob.

You can double-click a numeric value box and enter a value directly from the keyboard.

The level meter located at the immediate right of the knob indicates the input level of the corresponding port.

On the knobs, you can use the following shortcuts and context menu.

Action	Operation
<Ctrl> (<command>) + click	Sets analog gain to the default value (-6 dB).
<Ctrl> (<command>) + <Shift> + click	Sets the analog gain to 0 dB.

Action	Operation
Right click	Displays the following context menu. [All Default] Sets the analog gain of all channels to the default value (-6 dB). [All 0dB] Sets the analog gain of all channels to 0 dB.



c. **[HPF] button**

This is an on/off switch for the high-pass filter that is built into the HA of the device. To specify the cutoff frequency, make settings in the [Edit window](#).

② **[+48V MASTER] indicator**

Indicates the master phantom power on/off status for the device (the on/off setting is switched on the device itself).

③ **[SYSTEM] indicator / [SYNC] indicator**

Indicates the status of the device or the Dante status. When you move the mouse cursor to this area, the display content appears as a popup. Also shows an information icon  or attention icon  depending on the device status.

④ **[PEAK HOLD] button**

If this button is on, the peaks of each level meter are held. When you turn this off, the peaks that had been held are cancelled.

Edit window

This appears if you double-click in the main area other than on a controller, or if you right-click and choose [Open Edit Window].

Here you can view and edit detailed HA settings for the device. To close the window, click the [x] button in the upper right if you're using Windows, or click the [x] button if you're using Mac.

The screen is explained here using the Rio3224-D as an example. The number of Port select tabs differs depending on the model.



① **Device name**

Shows the UNIT ID number and name of the device.

② **[PEAK HOLD] button**

If this button is on, the peaks of each level meter are held. When you turn this off, the peaks that had been held are cancelled.

③ **Port select tab**

For the Rio3224-D, Rio1608-D, Rio3224-D2 or Rio1608-D2, these tabs switch the ports that are shown.

④ **Port index**

Indicates the port number of the device. When you press this with the left mouse button, the indicator of the corresponding port of the device will light.

⑤ **[+48V] button**

Turns the HA phantom power on/off.

⑥ **[A.GAIN] knob**

Specifies the analog gain for the HA of the device. The current setting is shown in the numeric box located below the knob.

You can double-click a numeric value box and enter a value directly from the keyboard.

The level meter located at the immediate right of the knob indicates the input level of the corresponding port.

On the knobs, you can use the following shortcuts and context menu.

Action	Operation
<Ctrl> (<command>) + click	Sets analog gain to the default value (-6 dB).
<Ctrl> (<command>) + <Shift> + click	Sets analog gain to 0 dB.
Right click	Displays the following context menu. [All Default] Sets the analog gain of all channels to the default value (-6 dB). [All 0dB] Sets the analog gain of all channels to 0 dB.

⑦ **[GC] button**

Switches on/off the gain compensation that regularizes the signal level on the audio network. If this is on, the gain value fixed by gain compensation is displayed, and subsequent changes to analog gain is compensated by the compensation gain within the device; audio is transmitted to the Dante network at the gain value that was fixed immediately before this was enabled.

NOTE

There are limits to the amount of gain compensation. The maximum compensation is 24 dB when turning the knob toward the left, and 48 dB when turning the knob toward the right. For example if you apply gain compensation at 30 dB, compensation is maintained until you set the analog gain to 6 dB, but if you set the analog gain to 4 dB, the gain value that is output will be 28 dB. If in this state you return the setting to 6 dB or higher, compensation maintains the level at 30 dB.

⑧ **[FREQ] knob / [HPF] button**

Switches on/off the high-pass filter that is built into the HA of the device, and adjusts the cutoff frequency. The current setting is shown in the numeric box located below the knob.

If you <ctrl> (<command>) + click above the [FREQ] knob, the cutoff frequency is set to the default value (80 Hz).

For Ro8-D

The Ro8-D has no settings that can be operated, so only the [SYSTEM] indicator and [SYNC] indicator are shown.

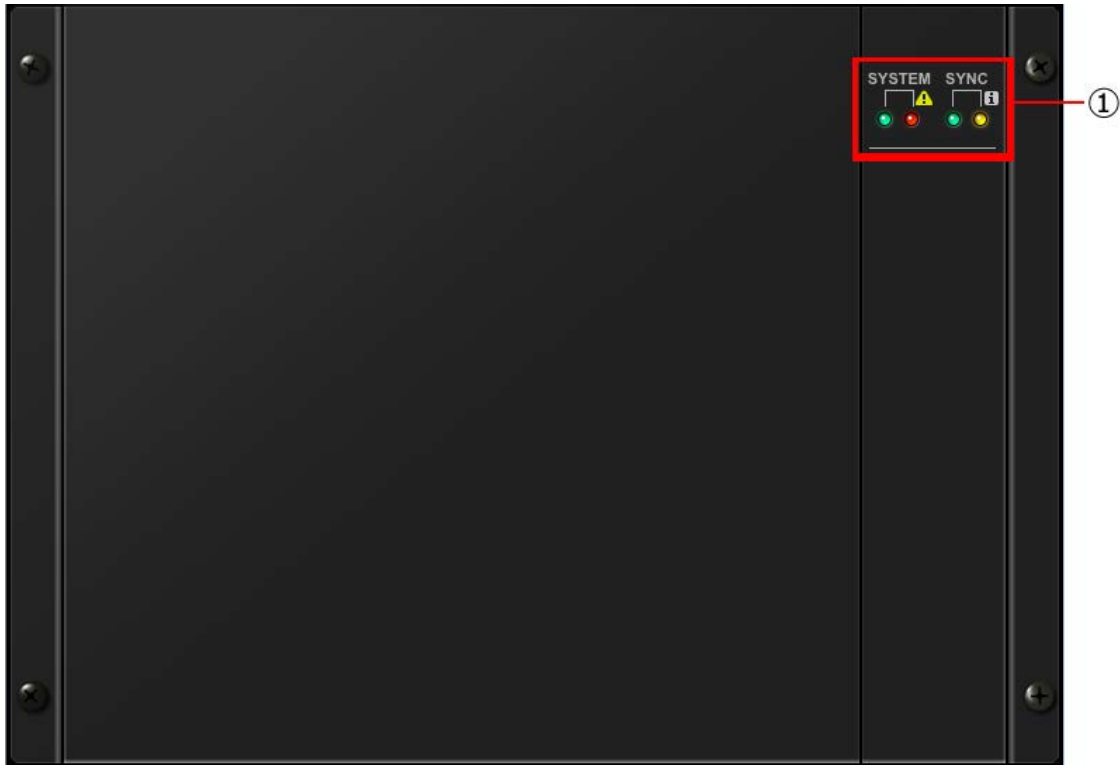

① **[SYSTEM] indicator / [SYNC] indicator**

Indicates the status of the device or the Dante status. When you move the mouse cursor to this area, the display content appears as a popup. Also shows an information icon **i** or attention icon **!** depending on the device status.

For RSio64-D

You can change the RSio64-D settings.

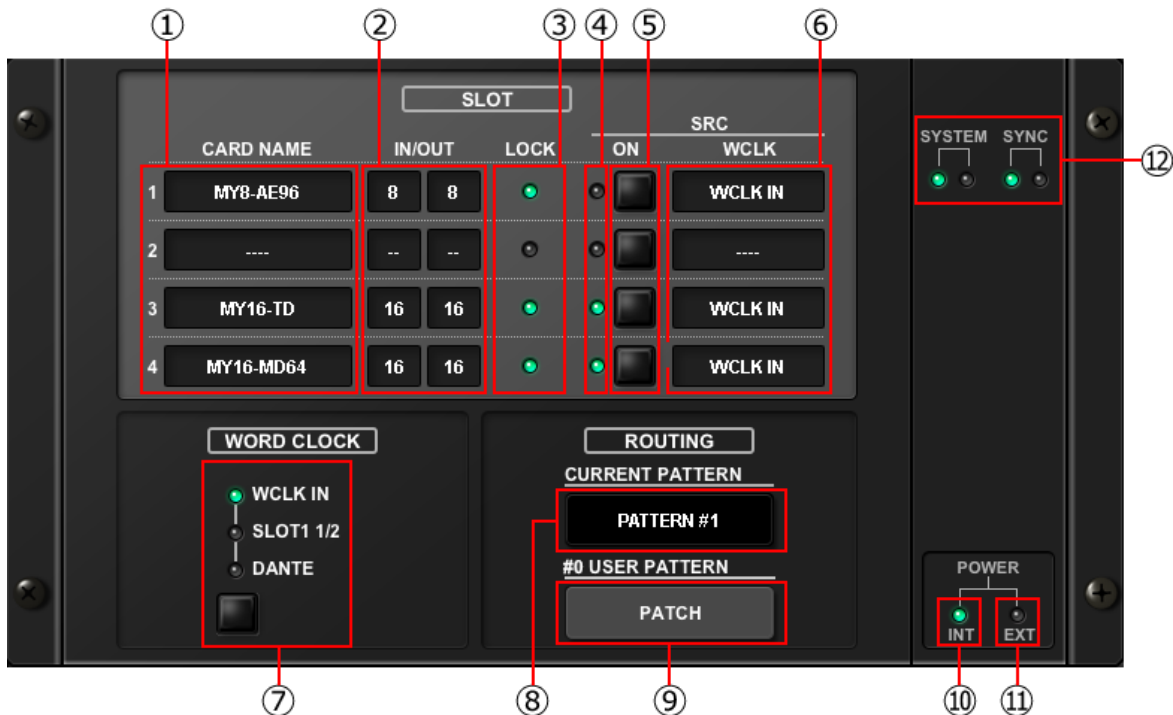

① CARD NAME

This indicates the names of the cards installed in slots 1 to 4. If nothing is installed, “----” will appear. If the MY8-AE96 is installed, “AE96S(w/SRC)” will appear if the SRC function in the card is on.

② IN/OUT PORT

This indicates the number of input and output ports for the cards installed in slots 1 to 4. If no card is installed, “--” will appear.

③ SLOT1~4 [LOCK] indicators

This indicates the word clock status for slots 1 to 4. If the word clock is operating normally, this indicator will be green.

Off	There is no card in the slot. Or, an unsupported card is in the slot.
Green (On) LOCK	Indicates that a clock synchronized with the clock source selected with the [WORD CLOCK] select key is being input from the card. If an external device is connected to the corresponding slot, input/output is occurring properly between that device and the RSio64-D. If the sampling frequency is close, this status may be displayed even if not synchronized.
Green (Flashing) SYNC ERROR	A valid clock is being input from the card, but is not synchronized with the clock source selected with the [WORD CLOCK] select key. If an external device is connected to the corresponding slot, input/output cannot occur correctly between that device and the RSio64-D. Turn SRC ON for correct input/output.
Red (On) UNLOCK	A valid clock is not being input from the card. If an external device is connected to the corresponding slot, input/output cannot occur correctly between that device and the RSio64-D.
Red (Flashing) WRONG WORD CLOCK	The frequency of the clock source selected with the [WORD CLOCK] select key is outside of the operating frequency range for the card inserted in the slot. Either set the frequency of the clock source within the operating range for the card, or turn [SRC] ON. For an analog card, if you turn [SRC] ON, the frequency is set to the 48kHz built into the RSio64-D.

④ **SLOT1~4 [SRC] indicators**

Indicate the Sampling Rate Converter (SRC) status for slots 1 to 4.

Off	SRC is off.
Green (On)	SRC is on, and the clock selected with the SRC WCLK DIP switches on the RSio64-D is being input correctly.
Red (On)	SRC is on, but an appropriate clock is not being input. The clock selected with the SRC WCLK DIP switches on the RSio64-D is either not being input or is not within the operating range. Either turn SRC off, or change the DIP switch settings.

NOTE

Use the SRC WCLK DIP switches on the RSio64-D to set the SRC clock sent to the Mini-YGDAI card inserted in the slot.

⑤ **SLOT1~4 [SRC] buttons**

Used to turn SRC on/off at both IN and OUT for each slot.

⑥ **WORD CLOCK source**

Indicates the SRC word clock source status for slots 1 to 4 the RSio64-D.

SLOT	When using the word clock signal being input from the card in the slot.
WCLK IN	When using the word clock signal being input from the WORD CLOCK IN connector on the rear panel.
CARD	When the SRC function in the card is on.
----	If there is no card in the slot.

⑦ **WORD CLOCK select button**

Used to select the word clock source for the RSio64-D.

- WORD CLOCK WCLK IN indicator
- WORD CLOCK SLOT1 1/2 indicator
- WORD CLOCK DANTE indicator

Indicates the word clock source status for the RSio64-D.

WCLK IN	On when using the word clock signal being input from the WORD CLOCK IN connector on the rear panel of the RSio64-D. Flashes*1 if there is no valid word clock input.
SLOT1 1/2	On when using the word clock for channels 1/2 of slot 1 for the RSio64-D. Flashes*1 if there is no valid word clock input. When using MY8-AEB*2, the word clock for channels 7/8 is used.
DANTE	On when using the word clock for the Dante network*3. (If there is no valid Dante signal input, the internal Dante module will generate a clock.)

*1 When flashing, Dante word clock*3 input/output is used.

*2 If you are using MY8-AEB, set the AE↔RSVD switch for the card to RSVD.

*3 If you make changes to the frequency of the Dante word clock, use Dante Controller.

⑧ **[CURRENT PATTERN] button**

If you click this button, the currently selected routing pattern on the RSio64-D is displayed. If you switch the routing pattern on the RSio64-D, it will be applied in 3 seconds.

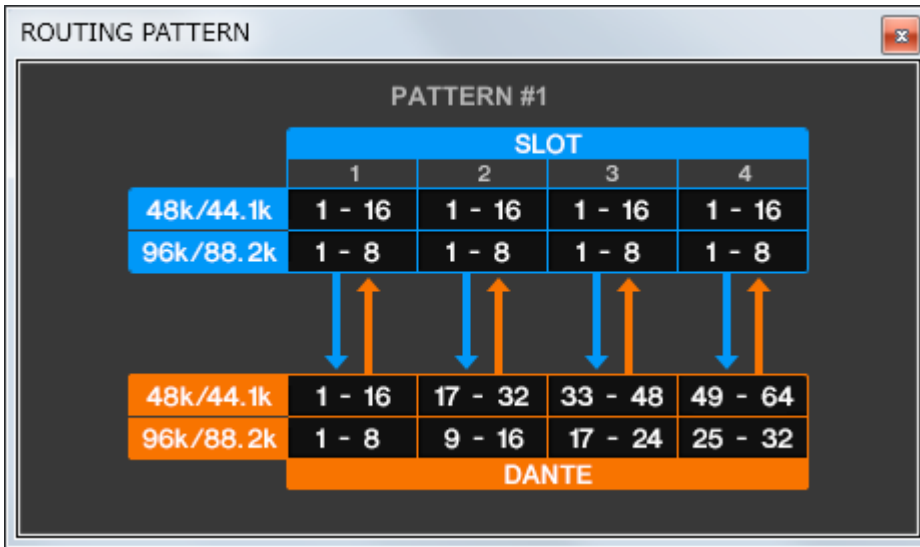

⑨ **[USER PATTERN] button**

Click this button to open the window for setting the audio routing user pattern in the RSio64-D.

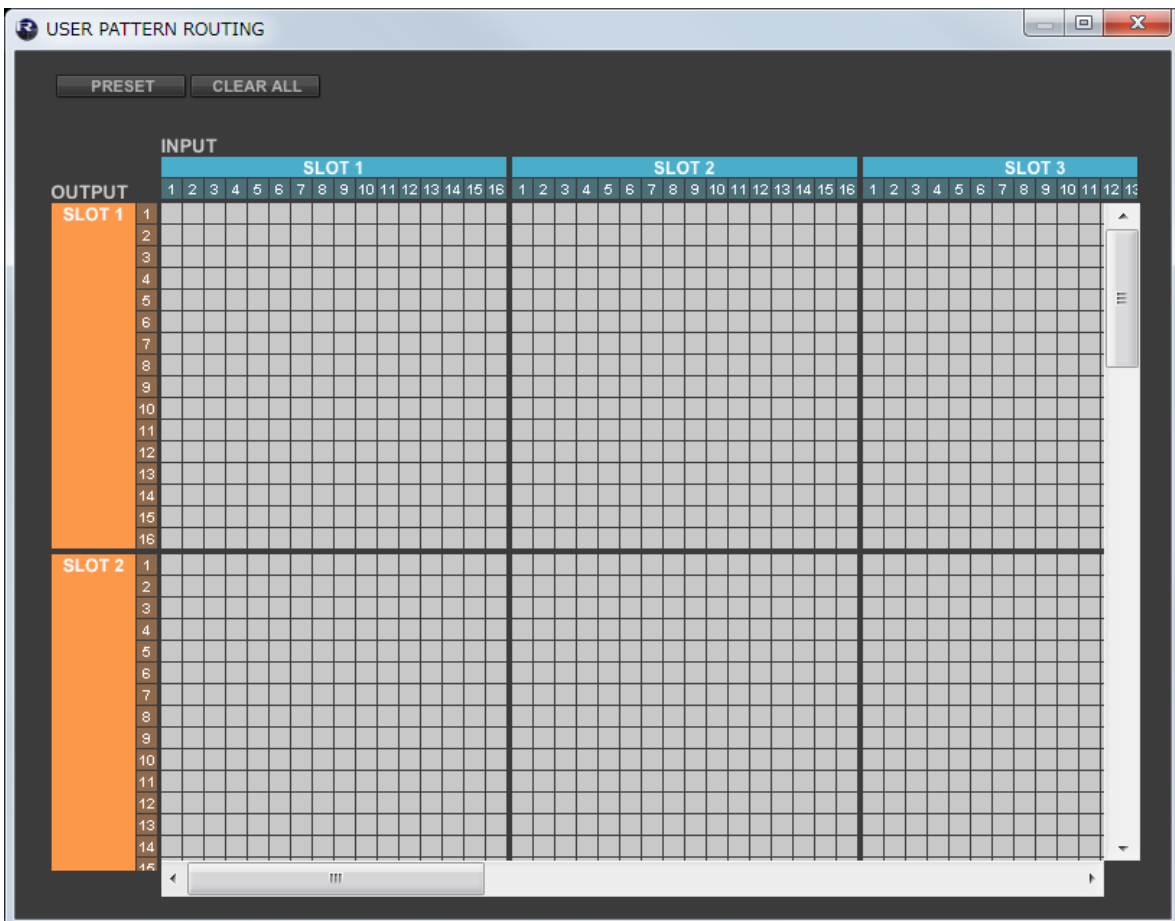

• PRESET button **PRESET**

As a template for editing the patch, you can call by selecting from preset patterns 1-7.

• CLEAR ALL button **CLEAR ALL**

Clear all patches.



⑩ **POWER INT indicator**

Indicates the status of the AC IN power supply for the RSio64-D.

⑪ **POWER EXT indicator**

Indicates the status of the EXT DC INPUT power supply for the RSio64-D. If the power supply is on, this indicator will be on.

⑫ **[SYSTEM] indicator/[SYNC] indicator**

Indicates the status of the device or the Dante status. When you move the mouse cursor to this area, the display content appears as a popup. Also shows an information icon  or attention icon  depending on the device status.

For RMio64-D

You can change the RMio64-D settings.

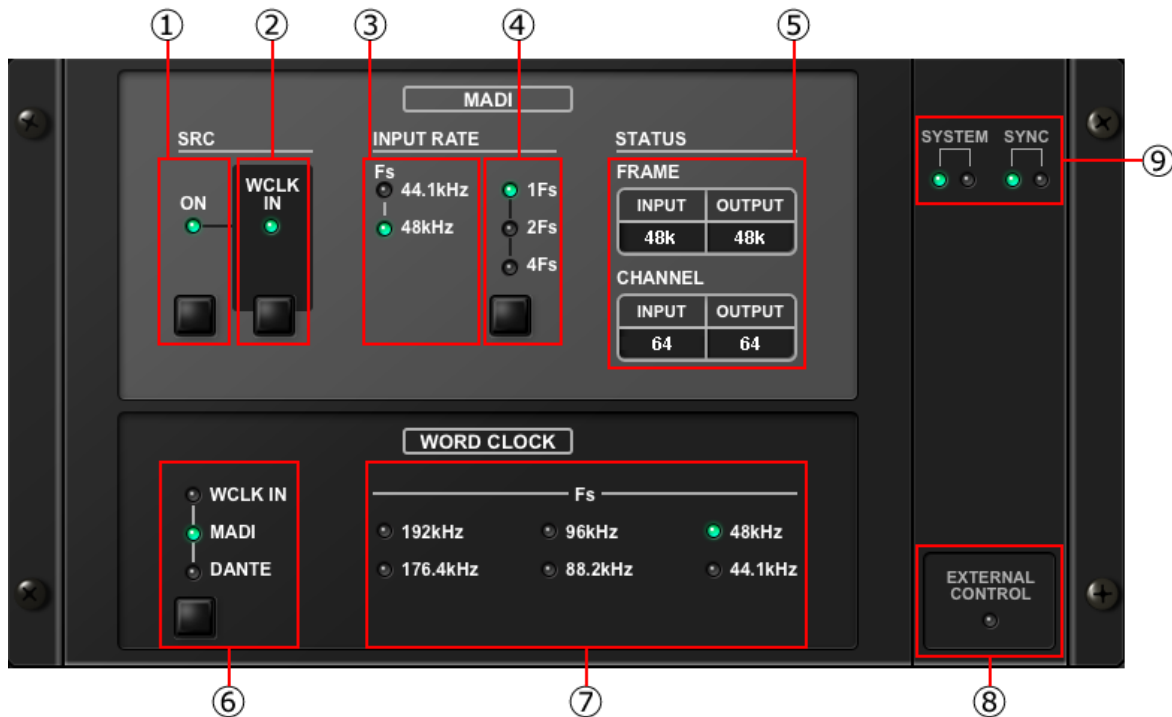

① **MADI [SRC ON] indicator**
MADI [SRC ON] button

Switches the SRC (Sampling Rate Converter) on and off.

② **MADI [SRC WCLK IN] indicator**
MADI [SRC WCLK IN] button

Use this button to select whether to use (indicator on) or not use (indicator off) the word clock input from the MADI WCLK IN FOR SRC jack on the rear panel of the RMio64-D as a standard clock for SRC.

③ **MADI [INPUT RATE Fs 44.1kHz] indicator**
MADI [INPUT RATE Fs 48kHz] indicator

Automatically detect and indicate whether the MADI input signal is 44.1 kHz or 48 kHz. Both indicators remain off if there is no valid MADI input signal.

④ **MADI [INPUT RATE 1Fs] indicator**
MADI [INPUT RATE 2Fs] indicator
MADI [INPUT RATE 4Fs] indicator
MADI [INPUT RATE] 1Fs/2Fs/4Fs button

Select either 1Fs (1x), 2Fs (2x), or 4Fs (4x), based on the MADI input frequency. For example, if the MADI input signal is 192 kHz (4x 48 kHz), confirm that the MADI INPUT RATE Fs 48kHz indicator is on and then select “4Fs”.

NOTE

When “2Fs” is selected, the unit automatically detects the frame frequency (48 kHz/96 kHz) of the MADI input signal.

⑤ **MADI [STATUS INPUT] status**
MADI [STATUS OUTPUT] status

Display information regarding the MADI input and output signals (frame frequency/number of channels).

⑥ **WORD CLOCK [WCLK IN] indicator**
WORD CLOCK [MADI] indicator
WORD CLOCK [DANTE] indicator
WORD CLOCK [WCLK IN/MADI/DANTE] buttons

Used to select the word clock source.

WCLK IN	Uses the word clock signal being input from the WORD CLOCK IN connector on the rear panel of RMio64-D. The indicators flash when there is no valid word clock input.
MADI	Uses the word clock of the MADI input signal. The indicators flash when there is no valid word clock input.
DANTE	Uses the word clock of the Dante network.

⑦ **WORD CLOCK [Fs] indicator**



Indicates the word clock frequency at which the unit is operating. Flashes when not synchronized.

⑧ **[EXTERNAL CONTROL] indicator**

This indicator comes on when there is a valid parameter that can be operated only externally by remote control.

Refer to “Remote Control” in the RMio64-D Owner’s Manual for details about parameters that can be operated by remote control.

⑨ **[SYSTEM] indicator /[SYNC] indicator**

Indicates the status of the device or the Dante status. When you move the mouse cursor to this area, the display content appears as a popup. Also shows an information icon  or attention icon  depending on the device status.

For Tio1608-D

You can change the Tio1608-D settings.



① **Device name**

Shows the UNIT ID number and name of the device.

② **[PEAK HOLD] button**

If this button is on, the peaks of each level meter are held. When you turn this off, the peaks that had been held are cancelled.

③ **Port select tab**

These tabs switch the ports that are shown.

④ **Port index**

Indicates the port number of the device. When you press this with the left mouse button, the indicator of the corresponding port of the device will light.

⑤ **[+48V] button**

Turns the HA phantom power on/off.

⑥ **[A.GAIN] knob**

Specifies the analog gain for the HA of the device. The current setting is shown in the numeric box located below the knob.

You can double-click a numeric value box and enter a value directly from the keyboard.

The level meter located at the immediate right of the knob indicates the input level of the corresponding port.

On the knobs, you can use the following shortcuts and context menu.

Action	Operation
<Ctrl> (<command>) + click	Sets analog gain to the default value (-6 dB).
<Ctrl> (<command>) + <Shift> + click	Sets analog gain to 0 dB.
Right click	Displays the following context menu. [All Default] Sets the analog gain of all channels to the default value (-6 dB). [All 0dB] Sets the analog gain of all channels to 0 dB.

⑦ [FREQ] knob / [HPF] button

Switches on/off the high-pass filter that is built into the HA of the device, and adjusts the cutoff frequency. The current setting is shown in the numeric box located below the knob. If you <ctrl> (<command>) + click above the [FREQ] knob, the cutoff frequency is set to the default value (80 Hz).

“Network Setup” dialog box

This appears when you choose [File] menu -> [Network Setup].

Here you can select the network interface card of the computer that will be used to communicate with the devices (subsequently called “the network card”).

NOTICE The various parameter settings are initialized if you change network cards. In order to use the current settings later, please save the settings to a file and change the network card.

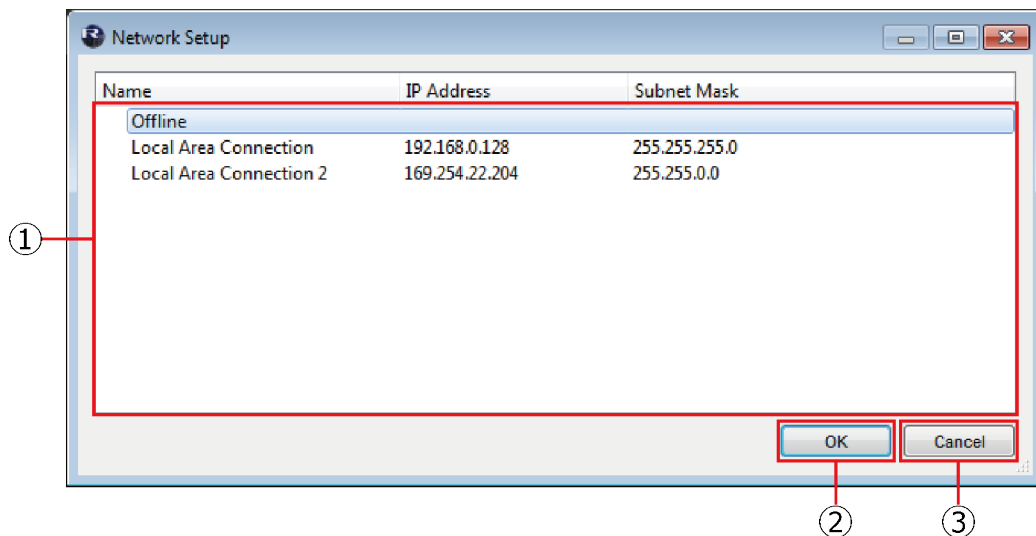

① Network card list

Select the network card that will be used to communicate with device. When you double-click a network card, the network card you double-clicked is selected and the dialog box closes.

If you only want to make settings without connecting a device, select [Offline]. If you select a network card while the status is [Online], data transmission load increases for the connected network.

② [OK] button

Update the settings and closes the dialog box.

③ [Cancel] button

Close the dialog box without updating the settings.

“Device Information” dialog box

This appears when you choose [File] menu -> [Device Information].
This lists information about the devices that are connected.

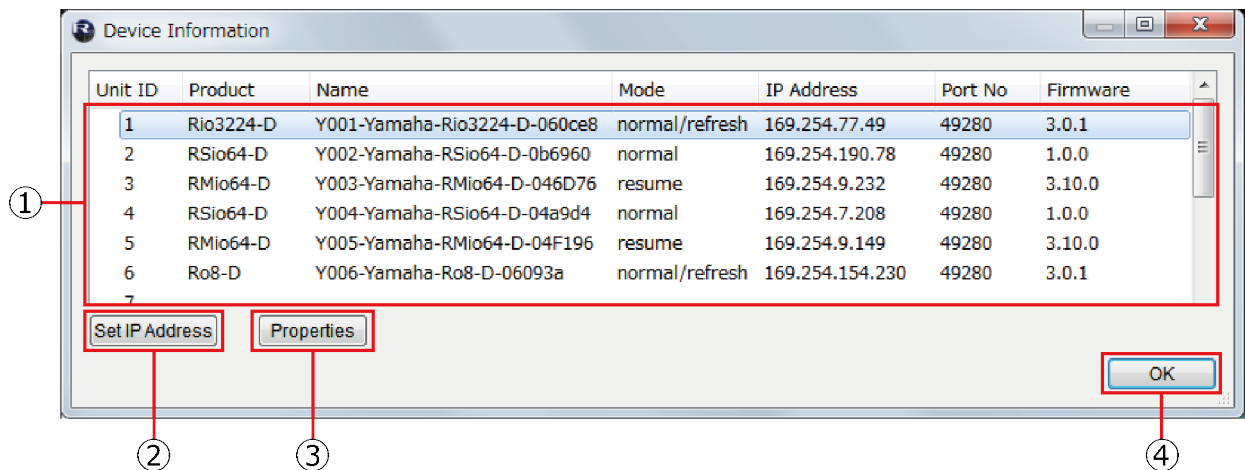

① **Device list**

By right-clicking the name of an item such as Unit ID, you can select the items that are shown.

- Unit ID
Shows the UNIT ID of the device.
- Product
Shows the model name of the device.
- Name
Shows the device name. This name can be edited in Dante Controller.
- Mode
Shows the START UP MODE of the device.
- IP Address
Shows the IP address that is specified for the device.
- Port No.
Shows the communication port number of the device.
- Firmware
Shows the main firmware version of the device.

② **[Set IP Address] button**

When you click this button, the [“IP Address” dialog box](#) will appear.

③ **[Properties] button**

When you click this button, the [“Properties” dialog box](#) will appear.

④ **[OK] button**

Closes the dialog box.

“IP Address” dialog box

This appears when you click the [Set IP Address] button in the "Device Information" dialog box. Here you can view the device's IP Select Mode status, or specify the IP address for a Static IP (Manual) device.

NOTE

For the RMio64-D, IP Select Mode is set in this dialog box instead of the DIP switch. This setting is available in firmware V4.10 or later.

If you want to use a device (excluding RMio64-D) in Static IP (Manual) mode, perform the following steps.

1. Start up the device in a mode other than Static IP (Manual).
2. Start R Remote.
3. In the "Device Information" dialog box, select the device that you will be setting to Static IP (Manual).
4. In the "IP Address" dialog box, enter the necessary information for Static IP (Manual).
5. Click the [OK] button.
6. Put the device in Static IP (Manual) mode, and restart.

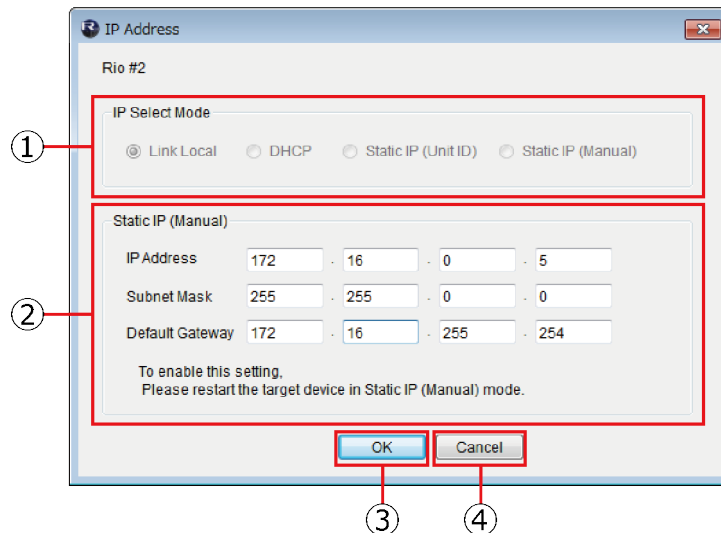

① **IP Select Mode**

Shows the IP Select Mode of the device.

② **Static IP (Manual)**

Specifies the IP address etc. that is used when the device starts with its IP Select Mode set to Static IP (Manual).

③ **[OK] button**

Saves the settings and closes the dialog box.

If you want to change to the IP address that is specified here, set the device's DIP switch to Static IP (Manual), and then restart the device.

④ **[Cancel] button**

Discards changes and closes the dialog box.

“Properties” dialog box

This dialog box appears when you click the [Properties] button in the "Device Information" dialog box. This displays information about the device that are connected.

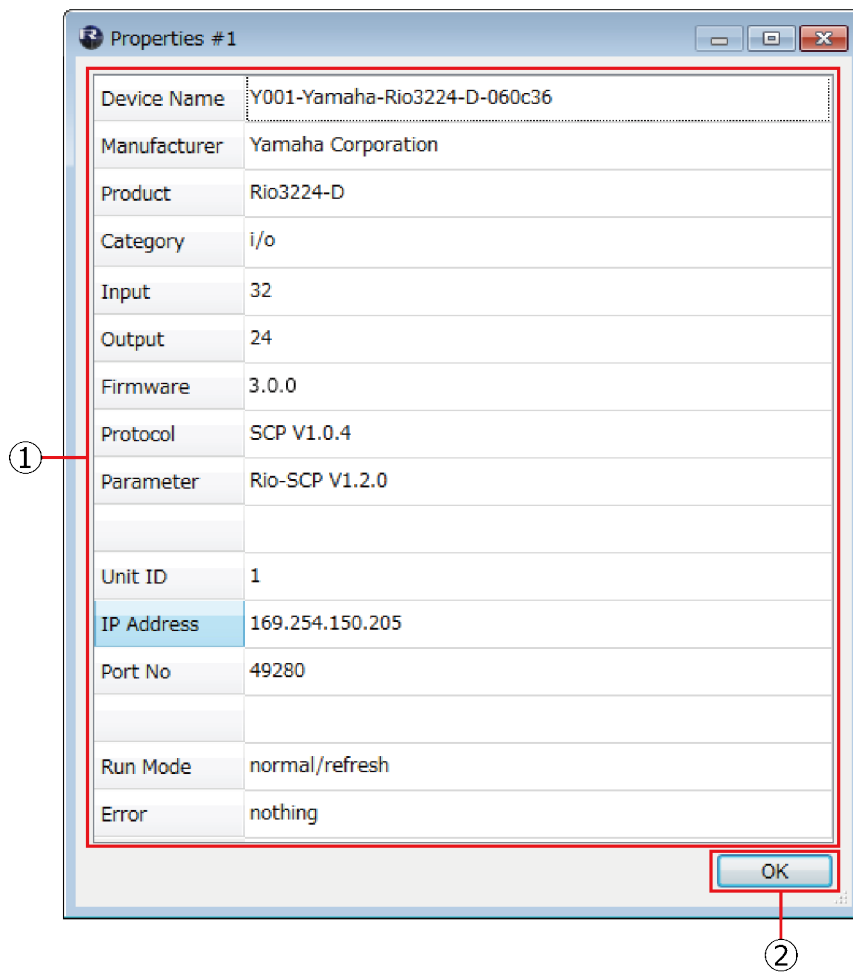

① **[Information] display area**

Shows information about the device. If the device is not connected, no information is shown.

② **[OK] button**

Close the window.

Updating the Firmware

This guide explains how to update the R series (Rio3224-D, Rio1608-D, Ri8-D, Ro8-D, RSio64-D, RMio64-D, Rio3224-D2 and Rio1608-D2) and Tio1608-D firmware by using the R Remote (V4.1 or later).

Precautions

- Note that the device may be damaged if you fail to follow these instructions properly, or turn off the device or disconnect the cable while the update is in progress.

Updating – Operation Overview

- 1 [Verify that your computer meets the updating requirements of the firmware. \(Page 4\)](#)



- 2 [Connect your computer to the device. \(Page 33\)](#)



- 3 [Configure the network settings. \(Page 10\)](#)

NOTE

To update the RMio64-D firmware, IPv6 must be enabled on the computer.



- 4 [Update. \(Page 36\)](#)

Connecting the Computer to the Device

Connect your computer directly to the Dante [PRIMARY] connector of the device to update.

NOTE

- Dante firmware cannot be updated if the device has been locked with Dante Device Lock. Unlock it from the Dante Controller. Although device firmware can be updated even if locked with Dante Device Lock, the old firmware version before updating is displayed on the Dante Controller and the I/O DEVICE screen of the CL/QL until the device is unlocked.
- When the device to be updated is a domain member of the DANTE DOMAIN MANAGER, unenroll the device from the DOMAIN, then connect the device and the computer to the same subnet.

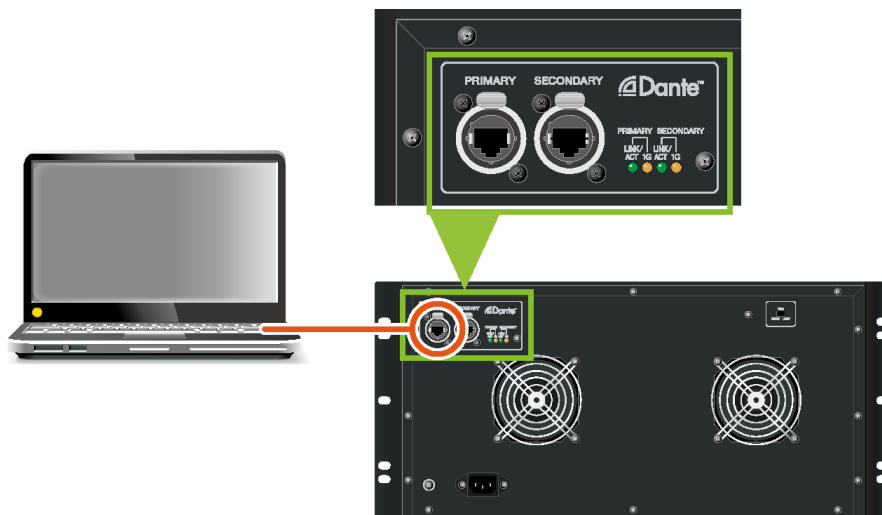

This figure is a connection example of the Rio3224-D.

You can perform the update, even when several sets of devices exist on a DANTE Network.

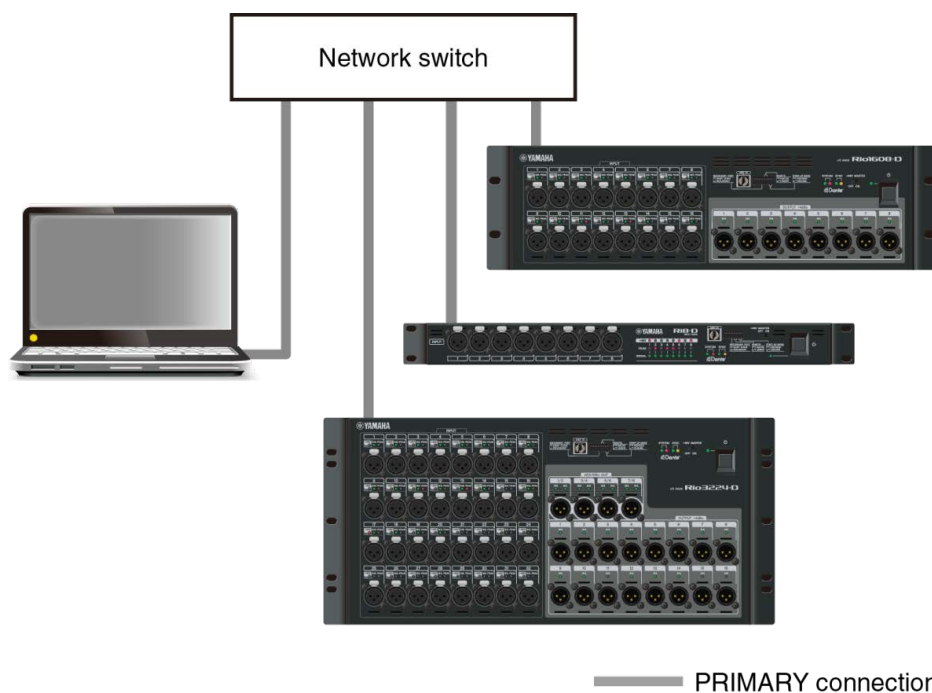

Network Settings

When setting up, refer to the description in the “[Specify the computer's IP address.](#)”
If the device is controllable from the R Remote, you can perform the update.

For specific instructions and cautions when connecting the devices, refer to the following web site:
<https://www.yamaha.com/proaudio/>

R Remote Firmware Updater

Each device has two types of firmware. One is for the device and the other is for Dante. Both of firmwares can be updated by the R Remote. Below are the windows of the R Remote Firmware Updater that appear when updating the firmware.

NOTE

When the device to be updated is a domain member of the DANTE DOMAIN MANAGER, the device's Dante firmware cannot be updated.

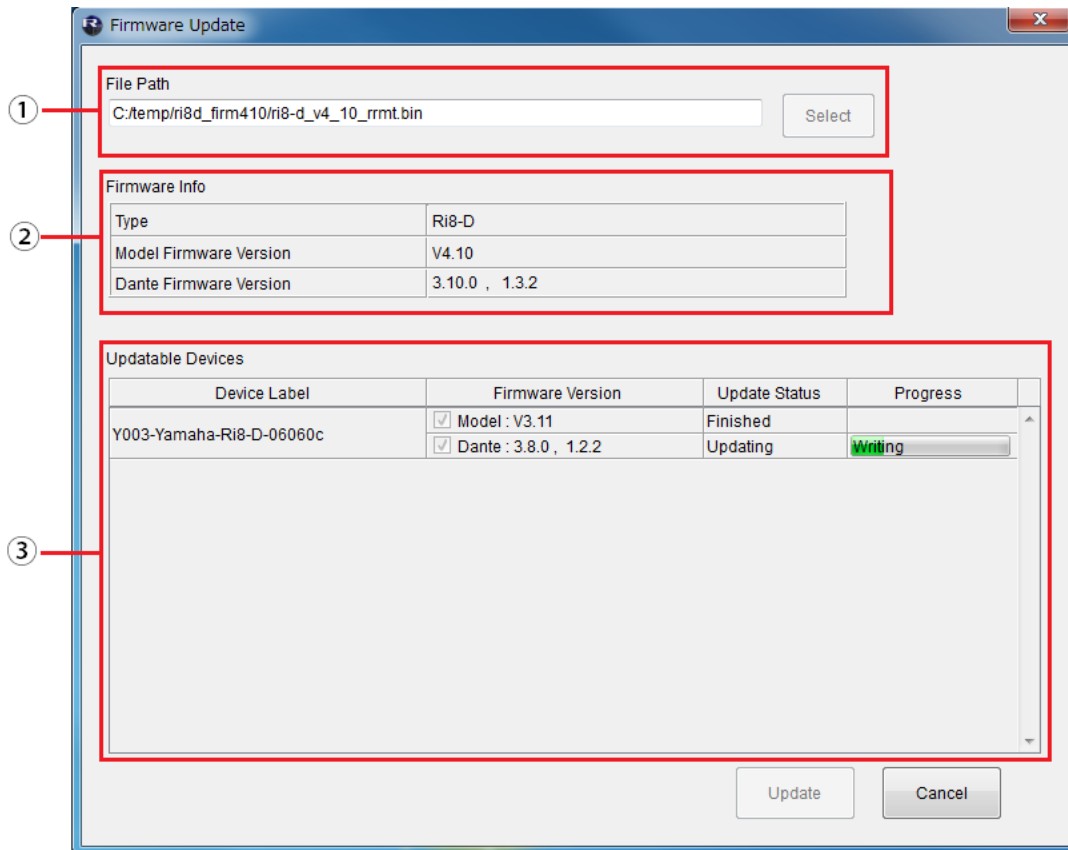

① File Path (File selection area)

Select the firmware file to be updated (displayed here).

② Firmware Info (File information area)

Displays information of the selected firmware.

③ Updatable Devices (Device information area)

Displays information about the devices to be updated.

Displays the device label, the firmware version (Model and Dante) and the status. When the device is a domain member of the DANTE DOMAIN MANAGER, the Dante firmware version is not displayed since the information cannot be retrieved.

The Update Status column displays the following information.

Message	Meaning
Waiting	Waiting for start of update
Updating	Update currently in progress
Cancelled	Update was cancelled.
Finished	Update has finished. The device needs to be restarted.
Completed	Update has finished and been confirmed.
Failed	Update has failed.

The “Progress” column of each firmware displays the following information.

Model:	Other than RMio64-D: Erasing → Transferring (and writing) RMio64-D: Writing
Dante:	Transferring → Writing

NOTICE Do not turn off the device or disconnect the cable while the update is in progress. The device may be damaged if you fail to follow these instructions properly.

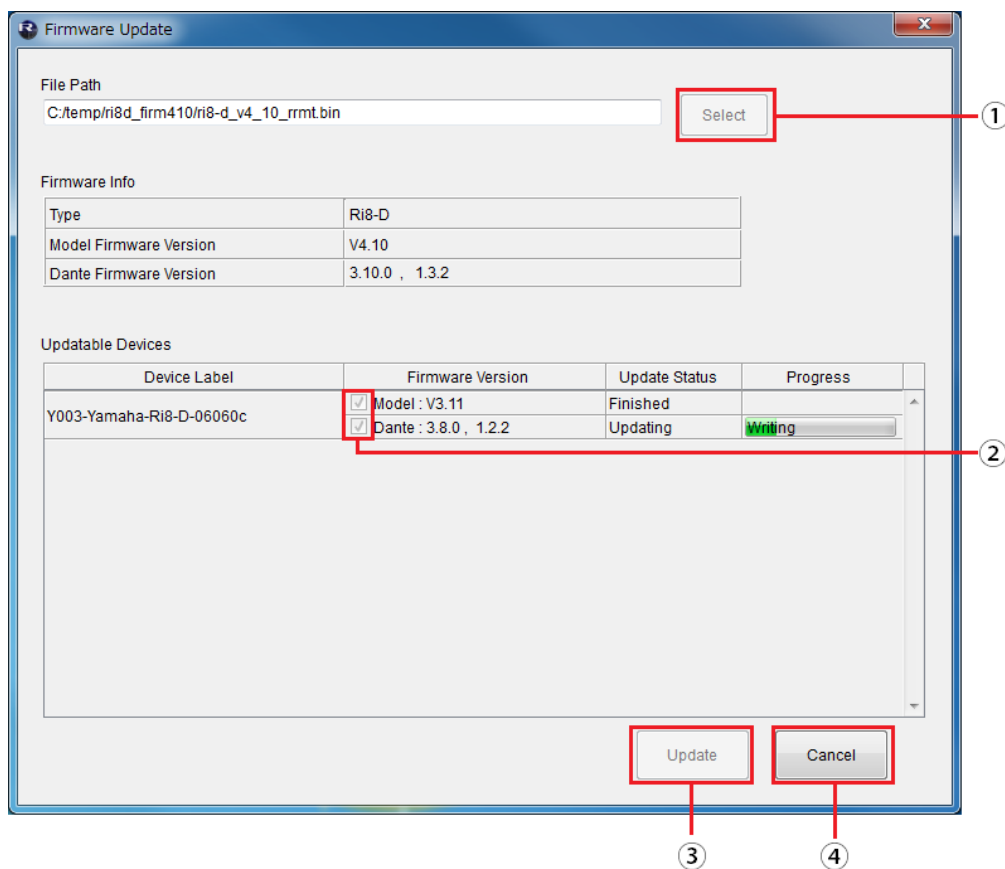

① **[Select] button**

Selects the file including the device firmware and the Dante firmware to be updated. The file “xxxx_v*_**_rrmt.bin” includes the two types of firmware, the firmware for the device, and the firmware for Dante.

NOTE xxxx represents the product name and *_** represents the firmware version number.
(E.g. rio3224-d_v4_10_rrmt.bin)

② **Checkbox**

Selects the device firmware (Model) and/or the Dante firmware with each device to be updated.

③ **[Update] button**

Starts the update process.

④ [Cancel] button

Stops the update operation of the device that has not been updated yet.

Update operation

This section describes how to update the firmware.

1. Start R Remote. Choose “Tool” → “Firmware Update” from the menu of R Remote.
2. (In the case of RMio64-D) Quit the NUAGE Workgroup Manager if it is running.
3. Press the “Select” button and select the firmware “xxxx_v*_**_rrmt.bin” to be updated.
Devices that can be updated appear in the device information area.

NOTE Firmware files can be downloaded from the following website:

<https://www.yamaha.com/proaudio/>

NOTE xxxx represents the product name and *_** represents the firmware version number.
(E.g. rio3224-d_v4_10_rrmt.bin)

NOTE When you select an old firmware which is not supported by R Remote, “invalid file” appears and the update cannot be started.

NOTE If the firmware of the device is an older version than the firmware file, the checkbox for its device will be automatically checked.

If the firmware of the device is a newer version or a same version, you will need to check the checkbox of the firmware to update manually.

NOTE When the firmware to be updated is selected, the “RRMT_****” folder is temporarily generated under your user folder of the computer. Do not move or delete this folder and its contents since these folders and files are used for updating. These folders and files are automatically deleted when you close the “R Remote Firmware Updater.”

4. Press the “Update” button to start the update.
5. When the update is complete, a popup window appears. Press the "OK" button.
6. To enable the new firmware, turn the updated device off and then on again.
If updated correctly, “Update Status” on the R Remote Firmware Updater will change from “Finished” to “Completed.”

Detecting the device

If you select the firmware file, all detected devices on the network that correspond to the file are displayed on the Device information area. Also, until the update is actually started, new detected devices corresponding to the file are added to the list as needed. Conversely, when a device is missing or disconnected due to the cable having been unplugged or some other reason, a “disconnected” indication is shown on the Firmware Version column of the device.

In case of failure in updating the firmware

Even if the update has failed, you can update the firmware again after R Remote detects the device. However, when a device is turned off while the update is in progress, the device cannot be started up, and it will not be shown on the Device information area of the R Remote, making it necessary to take the following actions for each problem.

When the device name is shown in red on the network grid view of the Dante Controller

- Dante firmware has entered failsafe mode. Recover (Failsafe Recovery) and update (Update Dante Firmware) the Dante firmware using Dante Firmware Update Manager.

NOTE The Dante Firmware Update Manager is compressed together with R Remote.

NOTE For details on recovering and updating after recovering, refer to the Dante Firmware Update Manager User Guide which is compressed together with R Remote.

1. Open the R Remote and perform steps 1 through 3 of the [“Update operation.”](#)

The “RRMT_****” folder is generated under your user folder of the computer.

NOTE Do not close the R Remote Firmware Update window until updating by Dante Firmware Update Manager is complete.

2. Recover the Dante firmware using “Failsafe Recovery” of Dante Firmware Update Manager.
3. Update the Dante firmware using “Update Dante Firmware” of Dante Firmware Update Manager.

NOTE Select the “FWUpdate_****.dnt” in the “RRMT_****” folder.

NOTE Check “Override Device Matching.”

4. After the update is complete, reboot the device, and confirm that the device is displayed on R Remote.

When the device’s red indicators light or flash

- The firmware of the device is damaged. Use R Remote Recovery Updater to update the firmware. Details on updating are as given below.

NOTE The RMio64-D is not supported by the R Remote Recovery Updater. For more information, contact qualified Yamaha service personnel.

1. Turn off the power to the device.
2. (For devices excepting the Rio3224-D2 and Rio1608-D2) Take note of the DIP switch settings of the device.
Follow the instructions in step 5 to change DIP switch settings. Take note of the original DIP switch settings in order to restore the settings after the update has been completed.
3. Disconnect the Ethernet cable from the Dante [PRIMARY] connector and [SECONDARY] connector on the rear panel of the device.
4. Connect the Dante [PRIMARY] connector on the rear panel of the device to the Ethernet connector on the computer using an Ethernet cable.
5. For the Rio3224-D2 and Rio1608-D2, turn the device on while simultaneously hold down the ► (INC) button and the encoder.
In except for Rio3224-D2 and Rio1608-D2, set the DIP switch 8 down (ON), the other switches up (OFF), and then turn the device on.

The device starts in Update mode. The device in Update mode shows:

Rio3224-D, Rio1608-D, Ri8-D, Rio3224-D2, Rio1608-D, Ri8-D2	All the +48V indicators starts flashing.
Ro8-D	The right red [SYSTEM] indicator and the right orange [SYNC] indicator start flashing.
RSio64-D	All the red indicators of SLOT and WORD CLOCK, and the right red indicator of SYSTEM and the right orange indicator of SYNC light up.
Tio1608-D	The STATUS INPUT/OUTPUT indicators start flashing.

6. Set your computer's IP address and subnet mask.

For details on settings, refer to the instructions in [“Specify the computer's IP address](#) on page 10.”

IP address: 192.168.0.101

Subnet mask: 255.255.255.0

7. Start the R Remote Recovery Updater.

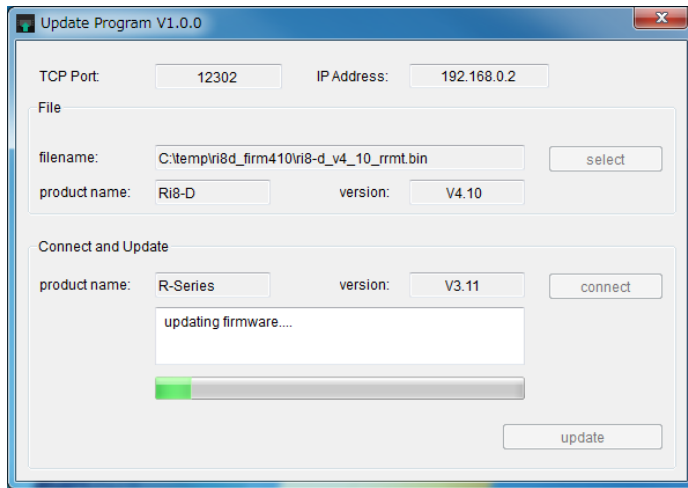

NOTE Within Windows, the “User Account Control” dialog box may appear. Click [Continue] or [Yes].

8. Press the “select” button and select the firmware “xxxx_v*_**_rrmt.bin” to be updated.

NOTE xxxx represents the product name and *_** represents the firmware version number.
(E.g. rio3224-d_v4_10_rrmt.bin)

NOTE When you select an old firmware file which is not supported by R Remote, an “invalid file” message appears and you cannot update the firmware. In this situation, use the exclusive update software for each product which is compressed with the old firmware. For details on updating, refer to the update guide for the exclusive update software for each product.

9. Press the “connect” button.

The device name and the firmware version are displayed in the “Connect and Update” column.

10. Press the “update” button to start the update.

NOTE “Updating firmware...” appears while updating.

11. After the update is complete, close the R Remote Recovery Updater.

NOTE When the update is complete, “Update was completed. Close this Update Program.” appears.

12. Turn off the power to the device.

13. (For devices excepting the Rio3224-D2 and Rio1608-D2) Restore the DIP switches to their original settings.

Messages

The following error, warning, and confirmation messages may be displayed on the popup window. Please follow the instructions.

■ Error messages

Message	Possible cause	Action
Cannot unpack the file. File path may be too long Make sure that the file path is less than 260 characters	Failed the temporary unpacking of the firmware file. File path may be too long.	Make sure that the file path is less than 260 characters.
Cannot unpack the file. User directory cannot be edited. Make sure that edits to this directory are permitted.	Failed the temporary unpacking of the firmware file. User directory cannot be edited.	Make sure that edits to this directory are permitted.
Invalid file. Select a valid file.	Invalid file or unsupported file was selected. The firmware file for R Remote contains the device firmware and the Dante firmware, unlike in previous files before R Remote was supported.	Select a valid firmware file. You can find "-rrmt" in a file name of the firmware file supported by R Remote.
Unexpected error occurred. Please restart the R Remote software and try again.	Unexpected error occurred.	Restart the R Remote software and try again.
Dante Control and Monitoring service not found. Make sure that the Dante Controller is installed and the service is running. Then restart R Remote software.	Dante Control and Monitoring service is not running.	Make sure that the Dante Controller is installed and the service is running. Then restart R Remote software.
Firmware update failed for device(s). Check network connection and try again.	Firmware update failed for device(s).	<ul style="list-style-type: none"> · Check the network settings (page 10) and network connection (page 33), and then try again. · If the device has been locked with Dante Device Lock, unlock it from the Dante Controller, and then try again. · If the device is connected to your computer via a network, connect your computer directly to the Dante [PRIMARY] connector of the device, and then try again.
Dante Network Setting Failed	Network settings for Dante Firmware Update has failed.	Change the Dante network settings using the Dante Controller. Refer to "Dante Controller User's Guide" for details.

■ Warning Messages

Message	Cause and action
Update in progress. Wait until update is completed	The Close button [X] was pressed during the update. Wait until update is completed.

■ Confirmation Messages

Message	Cause and action
Cancel update? This will cancel the update of all waiting devices.	The [Cancel] button was pressed during the update. Press the [Yes (Y)] button to cancel the update or press the [No (N)] button to continue the update.
Close? One or more devices have not been updated yet.	The Close button [X] was pressed while one or more devices which failed the update exists. Press the [Yes (Y)] button to quit the R Remote or press the [No (N)] button to continue the update.
Select file? One or more devices have not been updated yet.	The [Select] button was pressed while one or more devices which failed the update exists. Press the [Yes (Y)] button to select a firmware file or press the [No (N)] button to cancel the selection.

■ Other Messages

Message
New updatable device found.
Firmware update successfully completed.

Troubleshooting

Problem	Possible cause	Action
The device is not connected.	The device's power switch is not on.	Turn the power switch on.
	The device's DIP switch settings are incorrect.	Refer to " Set on the devices. " and make the appropriate settings.
	The UNIT ID of the device is set to something other than 1 through 24.	Specify a UNIT ID in the range from decimal 1 to 24 (hexadecimal 1 to 18). For more about these numbers, refer to " Decimal/hexadecimal conversion table. "
	The cables are not connected properly.	If the orange [SYNC] indicator is blinking, the cable is either broken or not connected correctly. Connect the cable correctly.
		If you're using REDUNDANT mode, connect to the network switch that is connected to the [PRIMARY] connector.
	The computer's IP address setting is incorrect.	Set the computer's IP address to match the device's DIP switch setting.
	Network card selection is incorrect.	In the " Network Setup " dialog box, select the network card that communicates with the device.
	Firmware is old.	Update the firmware to the version supported by R Remote using exclusive update software for each product. For information about the firmware version which is supported by R Remote, refer to " System Requirements. "
	The R series unit is in AD8HR mode.	Set DIP switches 5 and 6 in the upward position to select NATIVE mode.
Audio is not input / Input level is low.	The device is connected to a different subnet from the computer due to DANTE DOMAIN MANAGER, etc.	Connect the device and the computer to the same subnet.
	HA gain is not at an appropriate level.	Set the HA gain to an appropriate level.
	The external device is not outputting a signal.	Output a signal from the source device and make sure that the SIG indicators on the appropriate channels will light.
	Phantom power is not being supplied even though a condenser microphone is connected. Turn the [+48V MASTER] switch on.	Turn phantom power on for the corresponding channel.
	REFRESH mode is selected with the CL/QL series not connected.	Select RESUME mode.
Adjusting the HA gain does not change the audio level.	Gain compensation is on.	If you don't need gain compensation, turn gain compensation off.
[UNIT ID] rotary switch and DIP switch settings are not applied.	The settings were changed while the power was on.	Turn off the power before changing the settings.

Problem	Possible cause	Action
The device is not recognized.	Communication is blocked by the Windows firewall.	Perform the following procedure so that R Remote is not blocked by the Windows firewall. <ol style="list-style-type: none"> 1. Open Control Panel. 2. In the upper right, set "View by" to [Category]. 3. Click [System and Security]. 4. Click [Allow an app through Windows Firewall]. 5. In "Allowed apps and features," select the checkbox for "Yamaha R Remote" and also select the checkbox at the right. 6. Click the [OK] button to close Control Panel.
The device is unexpectedly disconnected.	(Mac) App Nap is not disabled.	Select the [Prevent App Nap] checkbox.
	The computer has entered sleep mode.	Set the computer so that it does not enter sleep mode.
The device to be updated is not displayed.	The Ethernet cable is not properly connected.	Directly connect the computer to the Dante PRIMARY connector of the device using an Ethernet cable. When you want to update the firmware via a network, check the connection between the devices to be updated and the computer to which the R Remote is installed via a network (page 33).
	The network settings are not correct.	Make the network settings according to the instructions in the " Specify the computer's IP address. " For the RMio64-D, enable the IPv6 on the computer which is used to operate the R Remote.
	The firmware file for updating is not selected.	Select the firmware file for updating (page 36).
	The UNIT ID of the device is not set to a valid number (1 to 24). Make sure that each device on the same network is assigned to a unique UNIT ID.	Specify a UNIT ID in the range from decimal 1 to 24 (hexadecimal 1 to 18). For more about these numbers, refer to " Decimal/hexadecimal conversion table. "
	The DIP switches of the device are not set up correctly.	Refer to the " Set on the devices. " For devices other than the RMio64-D, turn the device on with DIP switches 7 and 8 up when you update the device. Make sure to change the DIP switches' settings only after the device's power has been turned off.
	The network card that communicates with the device is not selected on the computer to which the R Remote is installed.	Select a network card for communication with the device from the " Network Setup " dialog box .
	Communication is blocked by the Windows firewall.	Perform the following procedure so that R Remote is not blocked by the Windows firewall. <ol style="list-style-type: none"> 1. Open Control Panel. 2. In the upper right, set "View by" to [Category]. 3. Click [System and Security]. 4. Click [Allow an app through Windows Firewall]. 5. In "Allowed apps and features," select the checkbox for "Yamaha R Remote" and also select the checkbox at the right. 6. Click the [OK] button to close Control Panel.

Problem	Possible cause	Action
	The device is connected to a different subnet from the computer due to DANTE DOMAIN MANAGER, etc.	Connect the device and the computer to the same subnet.
Update failed.	The device to be updated is locked by Dante Device Lock.	Unlock the Dante Device Lock of the device.
	---	Refer to " Messages " to solve the problem.

Decimal/hexadecimal conversion table

R Remote only uses values in the range of decimal 1 to 24.

Decimal	Hexa-decimal
1	1
2	2
3	3
4	4
5	5
6	6
7	7
8	8
9	9
10	A
11	B
12	C

Decimal	Hexa-decimal
13	D
14	E
15	F
16	10
17	11
18	12
19	13
20	14
21	15
22	16
23	17
24	18

Decimal	Hexa-decimal
25	19
26	1A
27	1B
28	1C
29	1D
30	1E
31	1F
32	20
33	21
34	22
35	23
36	24

Decimal	Hexa-decimal
37	25
38	26
39	27
40	28
41	29
42	2A
43	2B
44	2C
45	2D
46	2E
47	2F
48	30