

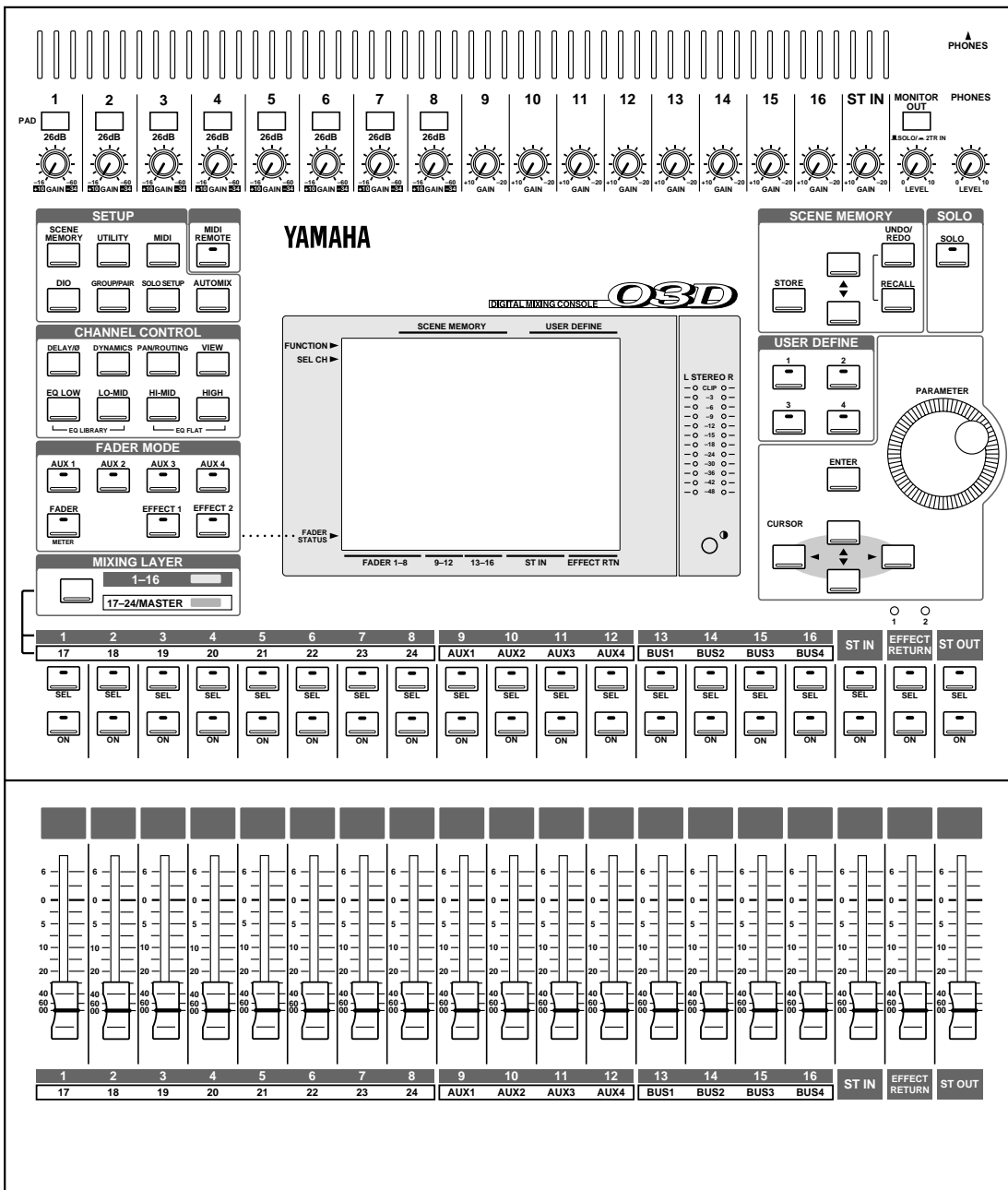

OSD

DIGITAL MIXING CONSOLE

Owner's Manual



FCC INFORMATION (U.S.A.)

1. IMPORTANT NOTICE: DO NOT MODIFY THIS UNIT!

This product, when installed as indicated in the instructions contained in this manual, meets FCC requirements. Modifications not expressly approved by Yamaha may void your authority, granted by the FCC, to use the product.

2. IMPORTANT: When connecting this product to accessories and/or another product use only high quality shielded cables. Cable/s supplied with this product MUST be used. Follow all installation instructions. Failure to follow instructions could void your FCC authorization to use this product in the USA.

3. NOTE: This product has been tested and found to comply with the requirements listed in FCC Regulations, Part 15 for Class "B" digital devices. Compliance with these requirements provides a reasonable level of assurance that your use of this product in a residential environment will not result in harmful interference with other electronic devices. This equipment generates/uses radio frequencies and, if not installed and used according to the instructions found in the users manual, may cause interference harmful to the operation of other electronic devices. Compliance with FCC regulations does not guarantee that interference will not occur in all installations. If this product is found to be the source of interference, which can be determined by turning the unit "OFF" and "ON", please try to eliminate the problem by using one of the following measures:

Relocate either this product or the device that is being affected by the interference.

Utilize power outlets that are on different branch (circuit breaker or fuse) circuits or install AC line filter/s.

In the case of radio or TV interference, relocate/reorient the antenna. If the antenna lead-in is 300 ohm ribbon lead, change the lead-in to coaxial type cable.

If these corrective measures do not produce satisfactory results, please contact the local retailer authorized to distribute this type of product. If you can not locate the appropriate retailer, please contact Yamaha Corporation of America, Electronic Service Division, 6600 Orangethorpe Ave, Buena Park, CA 90620

* This applies only to products distributed by YAMAHA CORPORATION OF AMERICA.

IMPORTANT NOTICE FOR THE UNITED KINGDOM

Connecting the Plug and Cord

WARNING: THIS APPARATUS MUST BE EARTHED

IMPORTANT: The wires in this mains lead are coloured in accordance with the following code:

GREEN-AND-YELLOW : EARTH
BLUE : NEUTRAL
BROWN : LIVE

As the colours of the wires in the mains lead of this apparatus may not correspond with the coloured markings identifying the terminals in your plug, proceed as follows:

The wire which is coloured GREEN and YELLOW must be connected to the terminal in the plug which is marked by the letter E or by the safety earth symbol or coloured GREEN and YELLOW.

The wire which is coloured BLUE must be connected to the terminal which is marked with the letter N or coloured BLACK.

The wire which is coloured BROWN must be connected to the terminal which is marked with the letter L or coloured RED.

* This applies only to products distributed by YAMAHA KEMBLE MUSIC (U.K.) LTD.

ADVARSEL!

Lithiumbatteri—Eksplodingsfare ved fejlagtig håndtering. Udskiftning må kun ske med batteri af samme fabrikat og type. Levér det brugte batteri tilbage til leverandoren.

VARNING

Explosionsfara vid felaktigt batteribyte. Använd samma batterityp eller en ekvivalent typ som rekommenderas av apparattillverkaren. Kassera använt batteri enligt fabrikantens instruktion.

VAROITUS

Paristo voi räjähtää, jos se on virheellisesti asennettu. Vaihda paristo ainoastaan laitevalmistajan suosittelemaan tyyppiin. Hävitä käytetty paristo valmistajan ohjeiden mukaisesti.

NEDERLAND

- Dit apparaat bevat een lithium batterij voor geheugen back-up.
- Raadpleeg uw leverancier over de verwijdering van de batterij op het moment dat u het apparaat aan het einde van de levensduur afdankt of de volgende Yamaha Service Afdeeling:
Yamaha Music Nederland Service Afdeeling
Kanaalweg 18-G, 3526 KL UTRECHT
Tel. 030-2828425
- Gooi de batterij niet weg, maar lever hem in als KCA.

THE NETHERLANDS

- This apparatus contains a lithium battery for memory back-up.
- For the removal of the battery at the moment of the disposal at the end of the service life please consult your retailer or Yamaha Service Center as follows:
Yamaha Music Nederland Service Center
Address: Kanaalweg 18-G, 3526 KL
UTRECHT
Tel: 030-2828425
- Do not throw away the battery. Instead, hand it in as small chemical waste.

Important Information

Read the Following Before Operating the 03D

Warnings

- Do not place a container with liquid or small metal objects on top of this unit. Liquid or metal objects inside this unit are a fire and electrical shock hazard.
- Do not locate the 03D in a place subject to excessive heat or in direct sunlight. This could be a fire hazard.
- Do not place the 03D in a place subject to excessive humidity or dust. This could be a fire and electrical shock hazard.
- Connect the 03D power cord only to an AC outlet of the type stated in this *Owner's Manual* or as marked on the 03D. Failure to do so is a fire and electrical shock hazard.
- Do not plug several devices into the same AC outlet. This can overload the AC outlet, and can be a fire and electrical shock hazard. It may also affect the performance of some devices.
- Do not place heavy objects on the power cord. A damaged power cord is a potential fire and electrical shock hazard.
- If the power cord is damaged (i.e., cut or a bare wire is exposed), ask your dealer for a replacement. Using the 03D in this condition is a fire and shock hazard.
- Hold the power cord plug when disconnecting from an AC outlet. Never pull the cord. Damaging the power cord in this way is a potential fire and electrical shock hazard.
- Do not place small metal objects on top of the 03D. Metal objects inside the 03D are a fire and electrical shock hazard.
- Do not block the 03D ventilation holes. The 03D has ventilation holes at the top and rear to prevent the internal temperature from rising. Blocked ventilation holes are a fire hazard.
- Do not try to modify the 03D. This could be a fire and electrical shock hazard.
- The 03D operating temperature is between 5°C and 35°C (41°F and 95°F).

Cautions

- Turn off all audio devices and speakers when connecting to the 03D. Refer to the owner's manual for each device. Use the correct cables and connect as specified.
- If you notice any abnormality—such as smoke, odor, or noise—turn off the 03D immediately. Remove the power cord from the AC outlet. Confirm that the abnormality is no longer present. Consult your dealer for repair. Using the 03D in this condition is a fire and shock hazard.
- If a foreign object or water gets inside the 03D, turn it off immediately. Remove the power cord from the AC outlet. Consult your dealer for repair. Using the 03D in this condition is a fire and electrical shock hazard.
- If you plan not to use the 03D for a long period of time, remove the power cord from the AC outlet. Leaving the 03D connected is a fire hazard.
- Do not use benzene, thinner, cleaning detergent, or a chemical cloth to clean the 03D. Use only a soft, dry cloth.

- The 03D is a heavy piece of equipment. Always grip the underneath, not the side panels, when lifting.

Interference

03D uses high-frequency digital circuits that may cause interference on radios and televisions placed close to it. If interference does occur, relocate the affected equipment.

Copyright

© 1997 Yamaha Corporation. All rights reserved.

No part of the 03D software or this *Owner's Manual* may be reproduced or distributed in any form or by any means without the prior written authorization of Yamaha Corporation.

Trademarks

ADAT MultiChannel Optical Digital Interface is a trademark and ADAT and Alesis are registered trademarks of Alesis Corporation.

Dolby, AC-3, and Pro-Logic are trademarks of Dolby Laboratories Licensing Corporation. Copyright 1992 Dolby Laboratories, Inc. All rights reserved.

Fostex and RD-8 are trademarks of Fostex Corporation.

Macintosh is a registered trademark of Apple Computer, Inc.

Pro Tools is a registered trademark of Digidesign or Avid Technology, Inc.

Tascam Digital Interface is a trademark and Tascam and TEAC are registered trademarks of TEAC Corporation.

Windows is a trademark of Microsoft Corporation.

All other trademarks are the property of their respective holders and are hereby acknowledged.

Package Contents

The 03D package should contain the following items. Make sure that you have them all.

- 03D Digital Mixing Console
- This Owner's Manual

Contact your Yamaha dealer if anything is missing.

Keep this manual for future reference!

Contents

1	Welcome to the 03D	1
	Welcome to 03D	2
	About this Owner's Manual	2
	03D Installation	2
	03D Features	3
	Key Feature Discussion	4
2	Touring the 03D	9
	Top Panel	10
	Rear Panel	16
	Block Diagram	21
3	Getting Around the User Interface	23
	About the User Interface	24
	Display	24
	Display Elements	28
	Cursor Buttons	29
	PARAMETER Wheel	29
	ENTER Button	29
	Mouse	30
	Mixing Layer	31
	Title Edit Dialog Box	33
4	Input Channels	35
	Input Channel Overview	36
	Phantom Power (input channels 1–8)	37
	Pad (input channels 1–8)	37
	Gain	37
	Metering	37
	Insert (input channels 1 & 2)	37
	Attenuator	38
	Phase	39
	Channel Delay	40
	Applying EQ to the Input Channels EQ	42
	Dynamics Processor	42
	Muting Input Channels (ON/OFF)	42
	Setting Input Channel Levels	42
	Pan, Balance & Routing	42
	Direct Outputs	43
	Aux Sends	43
	Monitoring Input Channels	43
	Input Channel Stereo Pairs	43
	Input Channels Block Diagram	44
5	EQ	45
	About 03D EQ	46
	Adjusting the EQ	47

Bypassing the EQ	47
Resetting the EQ Gain Controls	47
EQ Library	48
Storing EQ Programs	49
Recalling EQ Programs	50
Editing EQ Program Titles	51
Preset EQ Programs	52
6 Pan, Routing & Surround Pan	57
Selecting a Pan Mode	58
Stereo Pan, Balance & Routing	59
Stereo Pairs, Pan & Routing	61
Surround Pan	62
Using Surround Pan	65
7 Solo, Monitors & Meters	71
About Monitor & Solo	72
Monitor Outputs	73
Phones	73
Monitoring	74
Setting Up Solo	75
Using Solo	76
Solo Safe	77
Two-track Input	77
Solo Block Diagram	78
Metering	79
Monitor Block Diagram	82
8 Stereo Output	83
About the Stereo Output	84
Analog Stereo Outputs	84
DIGITAL STEREO OUT	84
Stereo Output & the YGDAI Interface	84
Rec Out & the Stereo Output	84
Solo & the Stereo Output	84
Monitoring the Stereo Output	84
Metering the Stereo Output	84
Routing Signals to the Stereo Output	84
Setting the Stereo Output Level	85
Muting the Stereo Output	85
Balancing the Stereo Output	85
Applying EQ to the Stereo Output	85
Stereo Output Dynamics Processor	85
Stereo Output Delay	86
Stereo Output Block Diagram	87
9 Aux Sends	89
About Aux Sends	90
Analog Aux Send Outputs	90
Aux Sends & the YGDAI Interface	90
Monitoring Aux Sends	90

Metering Aux Sends	90
Sending Channel Signals to Aux Sends	91
Pre-fader/Post-fader Aux Sends	92
Setting Aux Send Master Levels	93
Muting Aux Sends	93
Applying EQ to Aux Sends	93
Aux Send Dynamics Processors	93
Aux Send Stereo Pairs	94
Aux Send Block Diagram	95
10 Bus Outs	97
About Bus Outs	98
Analog Bus Outs	98
Bus Outs & the YGDAI Interface	98
Rec Out & Bus Outs 1 & 2	98
Monitoring Bus Outs	98
Metering Bus Outs	98
Routing Signals to Bus Outs	98
Setting Bus Out Master Levels	99
Muting Bus Outs	99
Applying EQ to Bus Outs	99
Bus Out Dynamics Processors	99
Bus Out Delay	100
Routing Bus Signals to the Stereo Bus	101
Bus Out Stereo Pairs	101
Bus Out Block Diagram	102
11 Channel Library & View	103
Channel Library	104
Storing Channel Programs	105
Recalling Channel Programs	106
Editing Channel Program Titles	107
Channel View	108
12 Groups & Pairs	111
Fader Groups	112
Mute Groups	113
Stereo Pairs	114
13 Onboard Effects	117
About the Onboard Effects	118
Preset Effects Programs	118
Applying Effects	122
Pre-fader/Post-fader Effects Sends	123
Effects Returns	123
Effects Library	125
Storing Effects Programs	126
Recalling Effects Programs	127
Editing Effects Program Titles	128
Effects Parameters	129
Effects Block Diagram	142

14 Dynamics Processors	143
About the Dynamics Processors	144
Patching in a Dynamics Processor	146
Dynamics Library	147
Storing a Dynamics Program	148
Recalling a Dynamics Program	149
Editing Dynamics Program Titles	150
Processor Types	151
Preset Dynamics Programs	157
15 Scene Memories	163
About Scene Memories	164
What's Stored in Scene Memories?	164
What's the Edit Buffer & Edit Indicator?	164
Scene Memory 00	165
Scene Memory Display Area	165
Scene Memory Buttons	165
Storing Mix Scenes	166
Recalling Mix Scenes	168
Undoing Mix Scene Recalls	169
Write Protecting Scene Memories	170
Editing Scene Memory Titles	171
Sorting Scene Memories	172
Setting a Fade Time	173
Recalling Scene Data Safely	174
16 Automix	175
About Automix	176
Creating a New Automix	180
Enabling Automix	180
Setting the Time Base	181
Setting an Automix Offset	182
Safe Channels	183
Selecting Parameters for Recording	184
Recording an Automix	185
Playing Back an Automix	187
Rerecording Events	188
Automix Punch-In/Punch-Out	189
Editing Fader Moves On-the-fly	190
Editing Events Off-line	193
Extracting Events	198
Undoing Automix Operations	200
Clearing the Undo Buffer	201
Storing Automixes	202
Recalling Automixes	203
Swapping the Current Automix	204
Editing Automix Titles	205
Clearing Automix Memories	206

17 Other Functions	207
User Define Buttons	208
Using the Onboard Oscillator	212
03D Preferences	213
Checking the Battery	214
Initializing the 03D	214
Calibrating the Faders	214
18 Digital I/O	215
Wordclock Setup	216
Digital Stereo Out	219
Output Dither	220
Digital Stereo In	221
Digital Input Monitor	222
YGDAI Cards	223
Cascading the 03D	227
19 MIDI	231
MIDI and the 03D	232
MIDI Connectors & TO HOST	232
MIDI & TO HOST Data Receive Indicators	233
MIDI/HOST Setup	233
MIDI Setup	235
MIDI Monitor	238
Program Change Assign	239
Control Change Assign	240
System Exclusive Parameter Control	241
Bulk Dump	242
MIDI Remote	243
Troubleshooting	251
Appendix A: General	253
03D Level Diagram	253
Display Messages	254
Security Cover	256
Rack-mounting Kit	256
03D VEK (Video Edit Suite Software)	256
Appendix B: Specifications	257
General Specs	257
Channel Specs	259
Memory/Library Specs	262
EQ Specs	262
Analog Inputs Specs	263
Analog Outputs Specs	264
Digital Inputs Specs	265
Digital Outputs Specs	265
YGDAI Interface Card Specs	265
Control I/O Specs	265
03D Dimensions	266

Appendix C: MIDI	267
Scene Memory to Program Change Table	267
Parameter to Control Change Table	268
MIDI Data Format	271
Appendix D: Resources	279
Books	279
Yamaha Web Site	279
Glossary	281
Index	285

Welcome to the 03D



In this chapter...

Welcome to 03D	2
About this Owner's Manual	2
03D Installation	2
03D Features	3
Key Feature Discussion	4

Welcome to 03D

Thank you for choosing the Yamaha 03D Digital Mixing Console. Based on the highly successful 02R Digital Recording Console, the new Yamaha 03D has been designed with music production and project studios in mind, although its unique and flexible features will also appeal to audio post and sound reinforcement and installation providers.

About this Owner's Manual

The 03D Owner's Manual contains all the information you need to use your 03D Digital Mixing Console. Use the table of contents to find general information and familiarize yourself with the organization of this manual, and use the index to search for specific items. A glossary of 03D-related jargon is provided on page 281.

Each chapter in this manual discusses a single area of the 03D. For example, "Input Channels" explains all about input channels, while "Scene Memories" explains all about scene memories. The contents of most chapters are obvious from the chapter title. Rather than repeat some explanations several times, items that are common to many channels, such as EQ and the dynamics processors, are explained in their own chapters.

Where possible, the individual sections of a chapter have been organized in order of signal flow. The "Input Channel" chapter, for example, starts with the input connectors and works through each input channel function, finishing up at the buses.

03D Installation

Site the 03D on a stable surface, somewhere that complies with the important information at the beginning of this manual. The 03D can be rack-mounted using the optional rack-mount kit.

03D Features

03D Sonic Specs

- Linear 20-bit 64-times oversampling A/D converters
- Linear 20-bit 8-times oversampling D/A converters (ST OUT, MONITOR OUT)
- 105 dB typical dynamic range (ST IN to ST OUT)
- 20 Hz–20 kHz (+1, –3 dB) frequency response
- 32-bit internal digital audio processing
- 44-bit digital EQ processing

03D Features

- 26 inputs (including 8 digital inputs)
- 18 outputs (including 8 assignable digital outputs)
- Continuously variable gain controls
- Balanced XLR inputs with +48 V phantom power on input channels 1 to 8
- 26 dB pad on input channels 1 to 8
- Balanced phone jack inputs on input channels 1 to 16
- Analog inserts on input channels 1 and 2
- AES/EBU and Coaxial-type digital inputs and outputs
- Eight assignable digital outputs via Yamaha's standard YGDAI interface
- YGDAI Cascade option for twin 03D or 03D and 02R operation
- Analog or digital stereo cascade for easy channel expansion
- Versatile solo modes for comprehensive monitoring
- Four fader groups for multiple channel control
- Four mute groups for multiple channel muting
- Stereo-pair operation for input channels, aux sends, and bus outs
- Four-band parametric EQ on virtually every input and output (160 bands of EQ)
- Powerful EQ library with 40 preset programs and 40 user programs
- Four aux sends with analog outputs
- Two onboard effects processors with 64 preset programs and 32 user programs
- Dynamics processor on virtually every input and output (36 in total)
- Powerful dynamics library with 40 preset programs and 40 user programs
- Powerful channel library with 2 preset programs and 49 user programs
- 51 scene memories for snapshot-style automation
- Built-in Automix function for mix automation referenced to MIDI timecode
- Large 320 x 240 dot liquid-crystal display with fluorescent backlight
- Optional PC-compatible serial mouse for quick navigation and editing
- Four user definable buttons for quick access to frequently used commands
- MIDI remote control of Programmable Mixer 01, 02R, 03D, ProR3, REV500, etc.
- Built-in MIDI interface for quick and simple connection to a personal computer
- 60 mm motorized faders

Key Feature Discussion

Configuration

The 03D provides a total of 26 inputs (including 8 digital inputs), stereo output (analog or digital), 4 bus outs, 4 aux sends, 2 internal effects sends, and 8 assignable digital outputs via a single YGDAI (Yamaha General Digital Audio Interface) slot. Each input channel features four-band parametric EQ and a dynamics processor. Input channels 1 to 8 feature balanced XLR and phone jack connections, with individually switched phantom power. Inputs 1 and 2 feature analog inserts. Input delays can be used for microphone-placement compensation, while output delays can be used for delay-compensation in multi-speaker systems. The number of inputs can be increased by digitally cascading two 03Ds together, sharing Bus, Aux, Stereo, and Solo buses. YGDAI digital inputs and outputs can be configured as bus outs, aux sends, input channel direct outs, or stereo outs. So although the 03D is a four-bus mixer, assigning the four buses and four aux sends, or the channel direct outs to the YGDAI slot's eight outputs allows eight-track simultaneous recording.

Benefits of a Digital Mixer

You're probably already familiar with the many benefits offered by digital audio, but what exactly are the benefits for digital audio mixing? Well, an audio mixer has the job of combining audio signals from various sources, at differing levels and impedances, usually into a stereo mix. And it must do this without introducing any new distortions and noise. Analog mixers do a pretty good job, but even with the best designs, nonlinear effects caused by circuit components are unavoidable.

In the digital realm, audio mixing consists of adding and multiplying binary numbers that represent audio signals. The DSP (Digital Signal Processor) chips used for these calculations never get their sums wrong. So once past the initial A/D conversion, audio signals are immune from signal degradation. With the 03D, noise, distortion, and crosstalk are virtually eliminated. You'll hear a new clarity in your mixes.

Once in the digital domain, it makes sense to keep audio data digital, as multiple AD/DA conversions can degrade signal quality. With the optional YGDAI interface cards, the 03D can be connected directly to a modular digital multitrack recorder, thereby keeping audio data in the digital domain for both recording and mixing. The final stereo mix can be transferred to a two-track digital recorder using the 03D's AES/EBU or Coaxial digital output.

Onboard digital effects and dynamics processors mean that signals remain in the digital domain, eliminating unnecessary AD/DA conversion. Signal processing is performed by third-generation Yamaha DSPs, as used in the Yamaha ProR3 Digital Reverberator.

03D Sonic Performance

The 03D's linear 20-bit 64-times oversampling A/D converters provide a typical dynamic range of 105 dB. The 03D can generate the industry standard sampling rates of 44.1 kHz and 48 kHz, or synchronize to an external wordclock source from 32 kHz $-6%$ to 48 kHz $+6%$. The stereo output and monitor output feature 20-bit 8-times oversampling D/A converters, while the aux sends and bus outs feature 18-bit 8-times oversampling D/A converters. Oversampling techniques effectively increase the internal sampling rate, so side effects caused by steep low-pass filters, which are used to filter out sampling frequency components during D/A conversion, are virtually eliminated. Consequently, audio signal integrity is maintained from input through to output.

Four-band Parametric EQ & Library

The 03D input channels, stereo input channel, stereo output, bus outs, aux sends, and onboard effects returns all feature four-band fully parametric EQ, with variable gain, frequency, Q, and bypass. That's 160 bands of EQ! High and low EQ bands can be used as shelving, peaking, or HPF and LPF, respectively. See EQ on page 45 for more information.

EQ settings can be stored as programs in the EQ library, with all channel settings in a channel library program, or with all mix settings in a mix scene. Real-time EQ adjusts can be automated using the onboard Automix function. See Automix on page 175 for more information.

The EQ library contains 40 preset programs and 40 user programs. User programs allow you to store frequently used EQ settings, and they can be titled for easy identification. The unique collection of preset EQ programs are designed for specific applications and instruments, and provide a good reference and starting point when making EQ adjustments. See EQ Library on page 48 for more information.

Motorized Faders

The 03D features 60 mm motorized faders that move automatically when a mix scene is recalled or an automix is played, providing a clear visual indication of fader levels. A fade time of up to 10 seconds can be set individually for each mix scene. Faders can be grouped together in one of four fader groups for multiple fader control. See Fader Groups on page 112 for more information. Faders of a pair of channels configured as a stereo pair move simultaneously. See Stereo Pairs on page 114 for more information.

The ST OUT and ST IN faders always control the stereo output and stereo input channel levels, respectively. The EFFECT RETURN fader controls the return levels of the two onboard effects processors. The operation of faders 1 to 16, however, depends on the selected mixing layer. When the mixing layer is set to 1–16, the faders work with input channels 1 to 16. When set to 17–24/MASTER, however, they work with input channels 17 to 24, the aux sends, and the bus outputs. See Mixing Layer on page 31 for more information. As well as perform channel level adjustments, faders are used as aux send and effects send level controls. Fader operation is set using the FADER MODE buttons. See Fader Mode on page 13 for more information.

Onboard Effects Processors

The 03D features two onboard stereo multi-effects processors: Effect 1 and Effect 2. These provide a wide range of quality effects, including reverb, delay, chorus, flange, amp simulator, and more. There are 34 different effects types available. The effects processors are fed by the Effect 1 and Effect 2 buses, and the processed signals are returned through the effects return channels. Effects can be applied to input channels and the stereo input channel.

Effects settings can be stored as programs in the effects library, which contains 64 preset programs and 32 user programs. User programs allow you to store your own effects programs, and they can be titled for easy identification. See Effects Library on page 125 for more information. Effects settings are also stored in mix scenes.

Existing outboard gear can be patched into the 03D via the four aux sends.

Onboard Dynamics Processors

Dynamics processors, providing compression, ducking, gating, and expansion, are available on all input channels, the stereo input channel, the stereo output, bus outs, aux sends, and the onboard effects returns. That's a total of 36 dynamics processors! Dynamics processors can be self triggering (i.e., the signal being processed is used as the trigger signal), or triggered by a signal from another channel.

Dynamics settings can be stored as programs in the dynamics library, with all channel settings in a channel library program, or with all mix settings in a mix scene. The dynamics library contains 40 preset programs and 40 user programs. User programs allow you to store your own dynamics programs, and they can be titled for easy identification. See Dynamics Library on page 147 for more information.

Existing signal processing gear can be patched into the 03D via the analog insert connections on input channels 1 and 2.

YGDAI & Digital I/O

The 03D features a single YGDAI slot, providing eight digital inputs and eight assignable digital outputs. The 03D accepts the same single-size YGDAI cards as the 02R Digital Recording Console. These cards provide a direct, digital connection to modular digital multitrack recorders, such as the Alesis ADAT, Tascam DA88 or DA38, and AES/EBU and Yamaha (Y2) format equipment. See YGDAI Cards on page 223 for more information.

In addition, AES/EBU and Coaxial digital stereo inputs and outputs allow direct connection to digital recorders and other digital devices. Digital stereo signals can be routed to the Stereo bus for cascade operation or to the stereo input channel for mixing and processing. See Digital Stereo In on page 221 for more information.

Easy-to-Learn GUI Interface

03D operation is both logical and intuitive. The large 320 x 240 dot display with fluorescent backlight uses graphical icons to represent controls, and provides a clear indication of current settings and EQ curves. A PC-compatible serial mouse can be connected for quick navigation and parameter editing. On/off-type parameters can be set with a simple click, and rotary controls can be dragged. The CH View page shows all settings of the selected channel at a glance. See Channel View on page 108 for more information.

Surround Pan

As well as normal stereo pan, the 03D features three surround pan modes: 2+2, 3+1, and 3+2+1. In conjunction with the stereo out and bus outs, surround pan controls allow you to pan channel signals in a two-dimensional space. Surround pan controls can be used to move sounds in a circular motion, ellipsis, semicircle, or straight line. Sounds can be moved around the two-dimensional space in real time using a mouse. Normal stereo pan and surround pan movements can be automated using the Automix function. See Surround Pan on page 62 for more information.

Scene Memories

On many mixers, the only way to store mix settings is with marker pen and masking tape. With the 03D, however, virtually every mix setting can be stored as a mix scene in one of the 03D's 50 scene memories. Mix scenes can be recalled instantly with just one button press, or MIDI Program Change command. Mix scenes can also be recalled as part of a dynamic automix, providing "total automation". If you work on several projects at a time, you can store the current mix scene so when you return to that project, you can start again right where you left off. Scene memories also make light work of night-after-night sound checks. Simply press recall to return to the previous night's mix settings. For theater work, scene memories allow accurate and repeatable sound changes between scenes.

Automix

The 03D's Automix function provides dynamic mix automation referenced to an external timecode source. The external timecode can be either MTC (MIDI Timecode) or MIDI Clock. Automix can be used to record and playback fader moves, channel mutes, EQ changes, pan, and more. In addition, mix scene, EQ, channel, effects, and dynamics library recalls can be included in an automix, combining snapshot and dynamic automixing for "total automation". Events recorded in an automix can be edited off-line. Fader moves can be edited "on the fly", or off-line using the Trim function. The Undo function can be used to revert to the previous automix after making changes that you do not want to keep.

MIDI

In addition to standard MIDI connectors, the 03D features a TO HOST connector. This allows the 03D to be connected directly to a personal computer without a MIDI interface. By connecting other MIDI gear to the 03D's standard MIDI connectors, the 03D can be used as MIDI interface for an entire MIDI system.

All mix parameters that can be stored in a mix scene can be controlled using MIDI System Exclusive messages. MIDI Program Change messages can be used to recall mix scenes. Up to 114 03D parameters can be assigned to MIDI Control Change messages for 03D control from a remote device. Scene memory, library, and automix data can be dumped to and from other MIDI devices, such as a MIDI data filer for backup and archive, a controlling computer, or another 03D. See MIDI on page 231 for more information.

MMC (MIDI Machine Control) commands can be assigned to the 03D's four USER DEFINE buttons for remote machine control (stop, play, rewind, forward, and record). Using the MIDI Remote function, other MIDI gear can be controlled using the 03D's faders, [ON] buttons, and PARAMETER wheel. The 03D comes with MIDI Remote pages for the following: Yamaha Programmable Mixer 01, 02R, and 03D digital consoles; Yamaha ProR3 and REV500 digital reverbs; GM and XG compatible tone generators; and Pro Tools. Custom pages can be configured for use with other MIDI gear.

Touring the 03D

2

In this chapter...

Top Panel	10
Rear Panel	16
Block Diagram	21

Top Panel

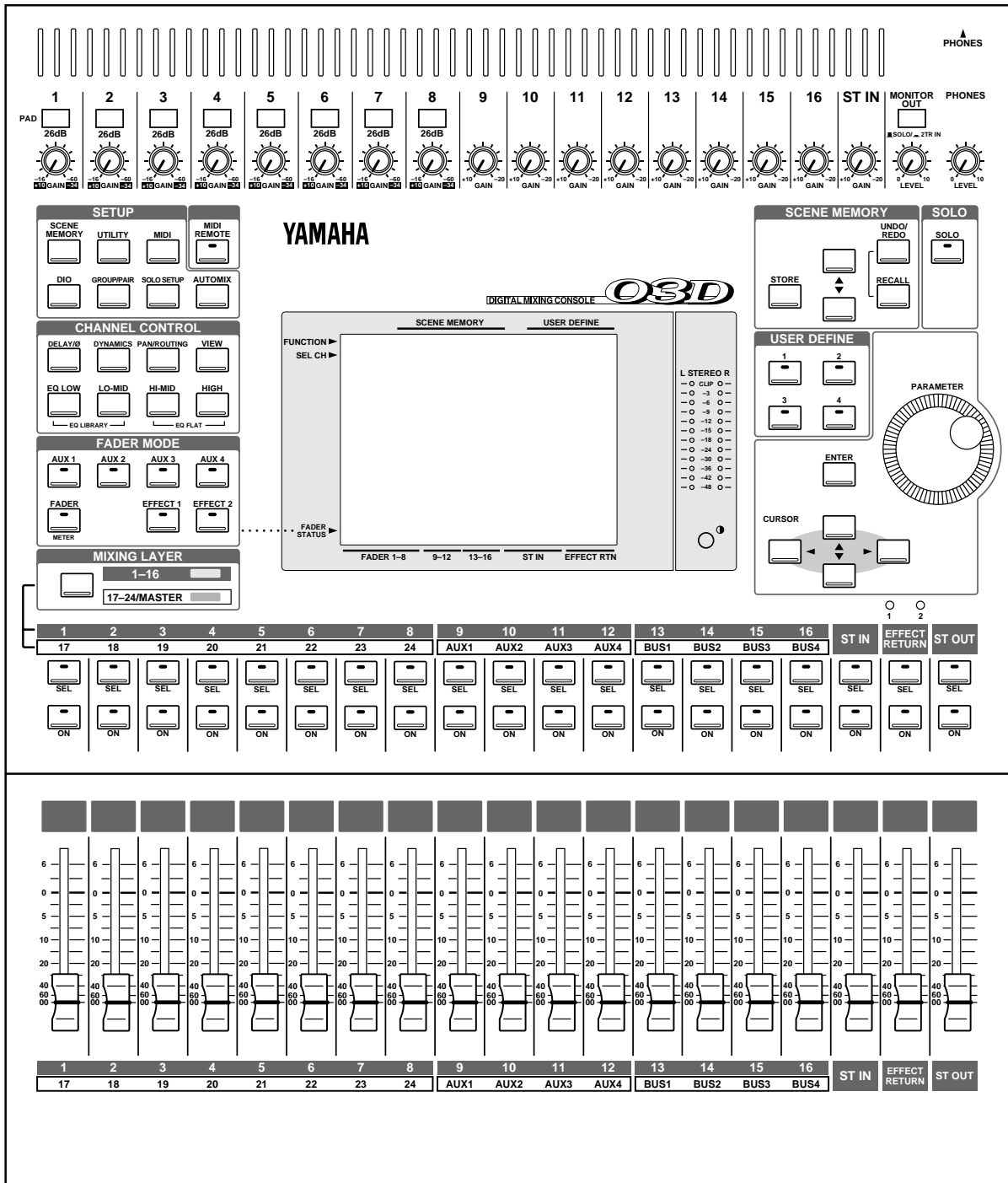

The individual sections of the 03D control surface are explained on the following pages.

Analog Control Section

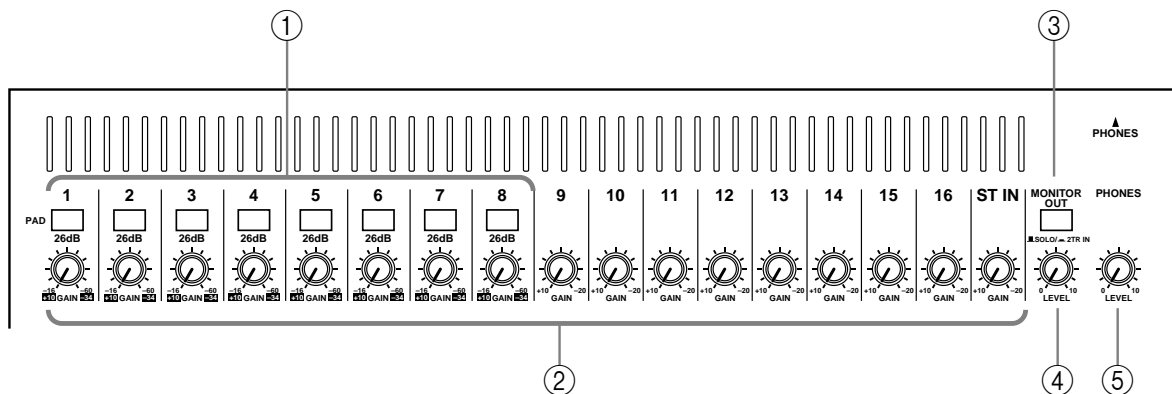

- ① **PAD switches**
These switches are used to turn on and off the input pads. See Pad (input channels 1–8) on page 37 for more information.
- ② **GAIN controls**
These controls are used to adjust the gain of the input preamps. See Gain on page 37 for more information.
- ③ **MONITOR OUT switch**
This switch is used to select the signal source—SOLO or 2TR IN—for the MONITOR OUT and PHONES.
- ④ **MONITOR OUT LEVEL control**
This control sets the level of the signals appearing at the MONITOR OUT connectors. The signal source is set using the adjacent MONITOR OUT switch.
- ⑤ **PHONES LEVEL control**
This control is used to adjust the phones level. The signal source is set using the MONITOR OUT switch.

Display & Stereo Meters

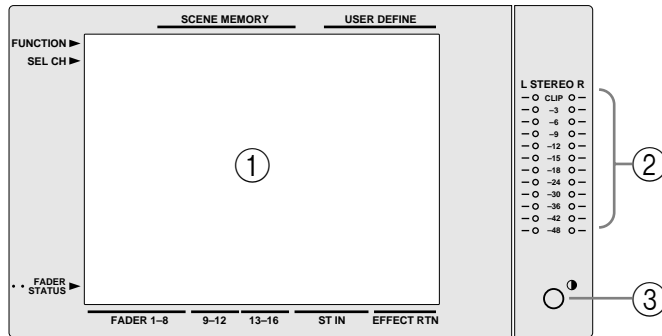

- ① **Display**
The large 320 x 240 dot display with fluorescent backlight provides clear indication of mix settings and operating status. As well as showing parameter values numerically, faders and rotary controls are represented graphically, so you can actually see pan and fader positions. The display also shows EQ curves and signal level meters. See Display on page 24 for more information.
- ② **Stereo Output Meters**
These 12-segment LED bar-type meters display the stereo output signal levels.
- ③ **Contrast**
This control is used to adjust the display contrast. Adjust it so that the display is clear and easy-to-read from your viewing position. You may need to readjust it when viewing the display from a different height or angle.

Setup

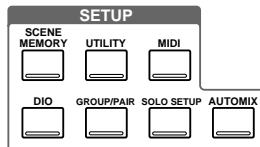

The Setup function buttons are used to access the following setup and configuration pages. The name of the selected function is shown on the display.

Button	Pages
SCENE MEMORY	Scene Mem., Fade Time, RCL. Safe, Sort
UTILITY	Oscillator, Prefer., User Def., MIDI/HOST, MIDI Moni.
MIDI	MIDI Setup, PGM Asgn., CTL Asgn., Bulk
DIO	D.in Setup, D.out Setup, Cascade, Monitor, Dither
GROUP/PAIR	Group, Pair
SOLO SETUP	Solo Setup, Moni. Setup
AUTOMIX	Main, Memory, Fader Edit, Event Edit, Extract

Channel Control

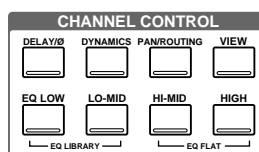

The Channel function buttons are used to access the following channel pages. The name of the selected function is shown on the display.

Button	Pages
DELAY/Ø	CH Delay, Dly 1–16, Dly 17–24, Output Dly, Phase
DYNAMICS	Dyn. Edit, Library
PAN/ROUTING	Pan 1-16, Pan 17–24, Surround, Bus to ST (when a surround pan mode is selected, the Bus to ST page is replaced by the Surr. 1–16 and Surr. 17–24 pages)
VIEW	CH View, Library
EQ LOW, LO-MID, HI-MID, HIGH	EQ
EQ LOW+LO-MID	EQ Library

Fader Mode

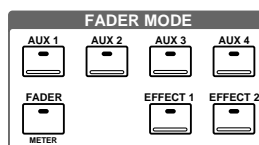

These buttons are used to select the following fader modes and display pages. The name of the selected fader mode is shown on the display.

Button	Fader Mode	Pages
AUX 1	CH AUX 1 send	AUX 1 Pre/Post, AUX Pan
AUX 2	CH AUX 2 send	AUX 2 Pre/Post, AUX Pan
AUX 3	CH AUX 3 send	AUX 3 Pre/Post, AUX Pan
AUX 4	CH AUX 4 send	AUX 4 Pre/Post, AUX Pan
FADER (METER)	Normal CH fader	CH 1–16, CH 17–24, YGDAI Out, Pre/Post
EFFECT 1	Effect 1 send	Eff. Edit, Library, Pre/Post
EFFECT 2	Effect 2 send	Eff. Edit, Library, Pre/Post

Fader functions are also affected by the Mixing Layer setting. See Faders on page 32 for more information. When a Setup or Channel Control button is pressed, the Fader mode automatically switches to Fader (i.e., normal fader mode).

Scene Memory

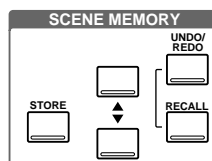

These buttons are used to select, store, and recall scene memories, and undo and redo scene memory recalls. See Scene Memories on page 163 for more information.

MIDI Remote



The [MIDI REMOTE] button activates the MIDI Remote mode. In this mode, the 03D faders and [ON] buttons of channels 1 to 16 can be used to control other MIDI equipment using MIDI commands. The indicator in the button lights up when the MIDI Remote mode is active. See MIDI Remote on page 243 for more information.

Solo

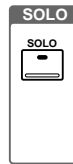

The [SOLO] button activates the SOLO mode. The indicator in the button flashes when the SOLO mode is active. See Setting Up Solo on page 75 for more information.

User Define

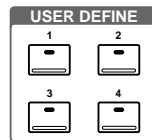

The USER DEFINE buttons are user-programmable buttons that can be configured to send specific MIDI or MMC (MIDI Machine Control) commands when pressed. They can also be used to recall frequently used mix scenes or effects programs, adjust mix settings of the selected channel, or control the Automix function. These buttons are configured on the User Def. page. See User Define Buttons on page 208 for more information.

Parameter Wheel, Cursors & Enter

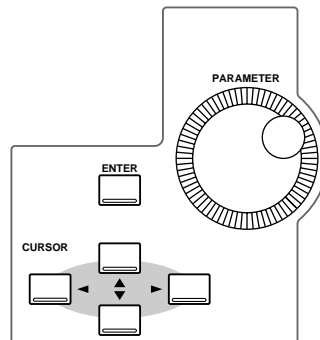

These controls are used to navigate around the display pages and edit parameters. See Getting Around the User Interface on page 23 for more information.

Mixing Layer, SEL buttons, ON buttons, Faders

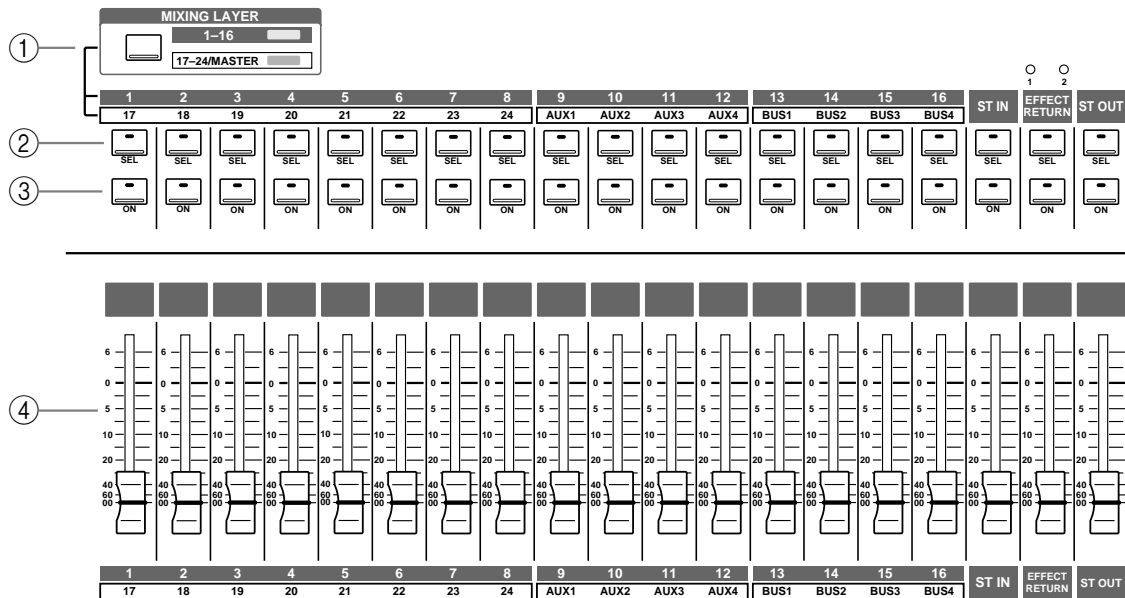

① MIXING LAYER button

The [MIXING LAYER] button determines the functions of the faders, [ON] buttons, and [SEL] buttons. When set to 1–16, these controls work with input channels 1 to 16. When set to 17–24/Master, however, they work with input channels 17 to 24, the aux sends, and the bus outputs. As well as the [MIXING LAYER] button, the function of the faders is determined by the fader mode setting. The Mixing Layer setting is shown on the display. See Display on page 24 for more information.

② SEL buttons

The [SEL] buttons are used to select channels for parameter editing. The name of the selected channel is shown on the display. See Display on page 24 for more information. The function of each [SEL] button depends on the selected Mixing Layer. See SEL Buttons on page 31 for more information. With automix, [SEL] buttons are used to select channels for recording. See Automix on page 175 for more information. The [SEL] buttons are also used to select channels for the fader and mute groups. See Groups & Pairs on page 111 for more information.

③ ON buttons

The [ON] buttons are used to turn input channels and outputs on and off. The function of each [ON] button depends on the selected Mixing Layer. See ON Buttons on page 31 for more information. When the [SOLO] function is on, [ON] buttons work as solo buttons, not mute buttons.

④ Faders

The faders are used to adjust input channel and output channel levels. The 03D features 60 mm motorized faders. The function of each fader depends on the selected fader mode and Mixing Layer. See Faders on page 32 for more information. The selected fader mode is shown on the display. See Display on page 24 for more information. In MIDI Remote mode, faders 1 to 16 can be used to control other MIDI equipment. See MIDI Remote on page 243 for more information.

Rear Panel

Rear Panel—Top Half

The top half of the rear panel consists of analog inputs and outputs.

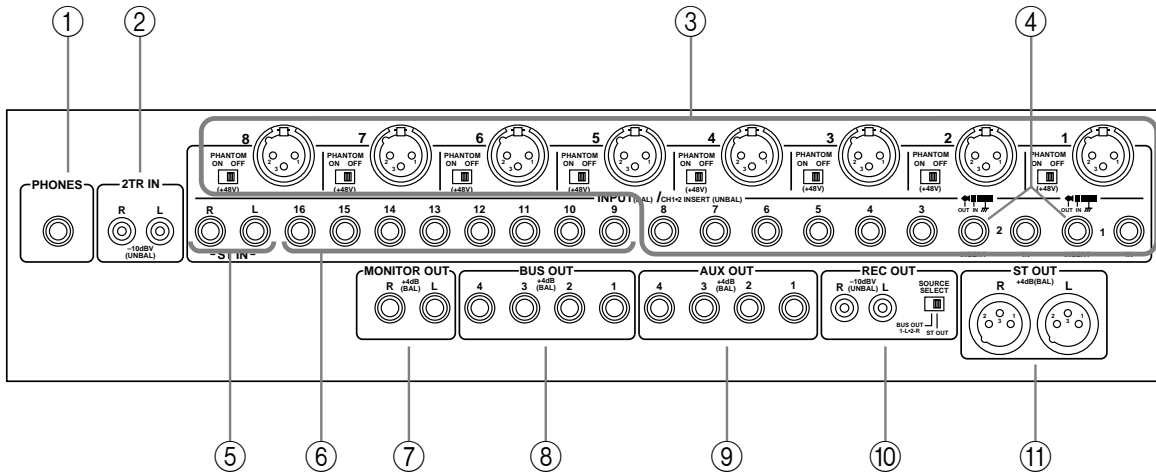

① **PHONES**

This is a stereo (TRS) phone jack. A pair of stereo headphones can be connected here for monitoring. The phones signal is the same as the MONITOR OUT. The phones level is set using the PHONES LEVEL control.

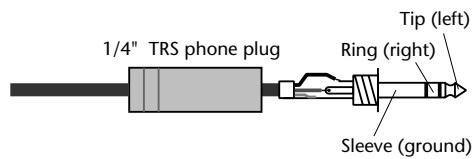

② **2TR IN**

These are phono jacks with a -10 dBV nominal input level. Signals input here are fed through to the MONITOR OUT SOLO/2TR IN switch and can be monitored via the MONITOR OUT and PHONES when that switch is set to 2TR IN. The stereo outputs of a master recorder can be connected here for confidence monitoring and master playback.

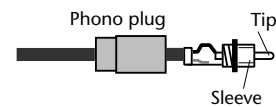

③ **INPUTs 1-8**

Input channels 1 to 8 feature balanced XLR-3-31-type and balanced phone jack connectors, both with a nominal input range of -60 dB to +10 dB. Individually switchable +48 V phantom powering is supplied to the XLR connector. The phone jack has priority over the XLR-type connector, so when a phone plug is inserted, the XLR-type connector is disconnected. The phone jack inputs can also be used with unbalanced phone plugs. With their high sensitivity and 26 dB PAD switches, these inputs can handle a wide range of signals, from condenser microphones to “hot” line levels.

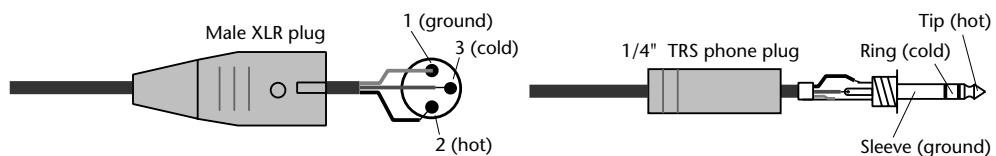

④ INSERTs (input channels 1 and 2)

These TRS phone jack connectors are used to connect signal processors for use with input channels 1 and 2 exclusively. Typically, compressors, limiters, and noise gates are connected to this type of connection. They are wired: sleeve–ground, ring–return, tip–send.

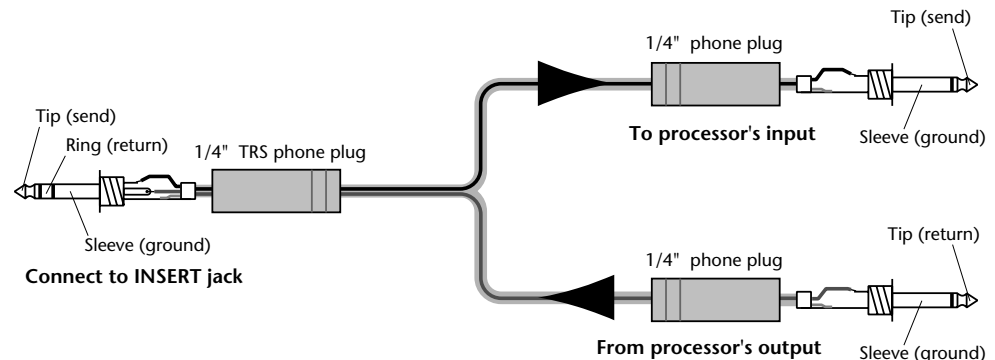

⑤ ST IN

These balanced phone jack inputs, with a nominal input range of -20 dB to $+10$ dB, are the inputs to the stereo input channel. Either balanced or unbalanced phone plugs can be connected. The stereo outputs of an external effects processor or other stereo device can be connected here.

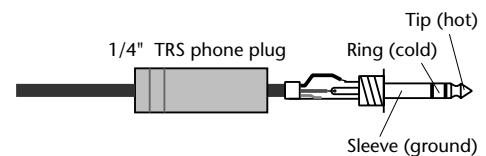

⑥ INPUTs 9–16

Input channels 9–16 feature balanced phone jack connectors with a nominal input range of -20 to $+10$ dB. Either balanced or unbalanced phone plugs can be connected. These inputs are best suited for line-level signals.

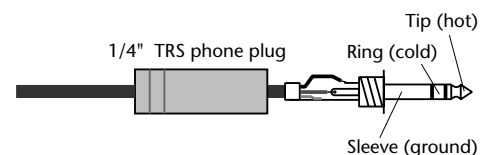

⑦ MONITOR OUT

These are balanced 1/4-inch phone jacks with a $+4$ dB nominal output level. Either balanced or unbalanced phone plugs can be connected. They output the monitor signals and should be connected to the inputs on a monitor amplifier. The monitor signal source is determined by the MONITOR OUT SOLO/2TR IN switch. The output level is set using the MONITOR LEVEL control.

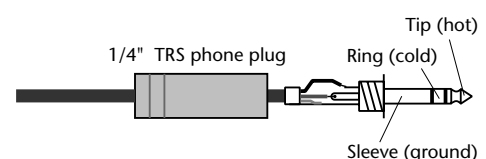

⑧ BUS OUTs

These are balanced 1/4-inch phone jacks with a $+4$ dB nominal output level. Either balanced or unbalanced phone plugs can be connected. They output the bus signals and can be connected to multitrack recorders, power amplifiers, and so on.

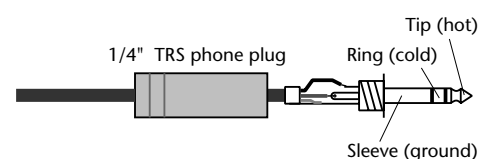

⑨ **AUX OUTS**

These are balanced 1/4-inch phone jacks with a +4 dB nominal output level. Either balanced or unbalanced phone plugs can be connected. They output the aux send signals and can be used to feed external effects processors, foldback amplifiers, and so on.

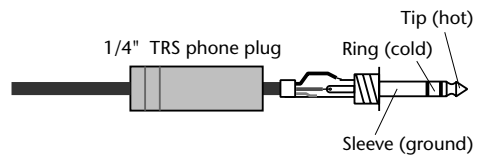

⑩ **REC OUT**

These are phono jacks with a -10 dBV nominal output level. The adjacent SOURCE SELECT switch is used to select the signal source: ST OUT or BUS 1 and BUS 2. They can be connected to a cassette, DAT, or other recorder.

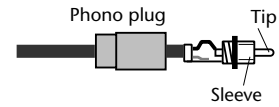

⑪ **ST OUT**

These are balanced XLR-3-32-type connectors with a +4 dB nominal output level. They are wired pin 1—ground, pin 2—hot (+), and pin 3—cold (-). They output the main stereo mix.

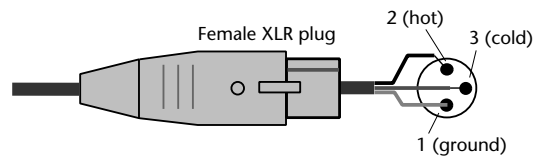

If you need to connect the balanced ST OUT to an unbalanced phone jack input, use a cable with the following wiring scheme (i.e., XLR pins 3 and 1 linked).

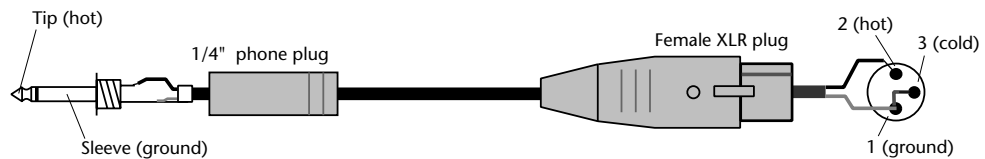

Rear Panel—Lower Half

The lower half of the rear panel consists of digital and control I/O.

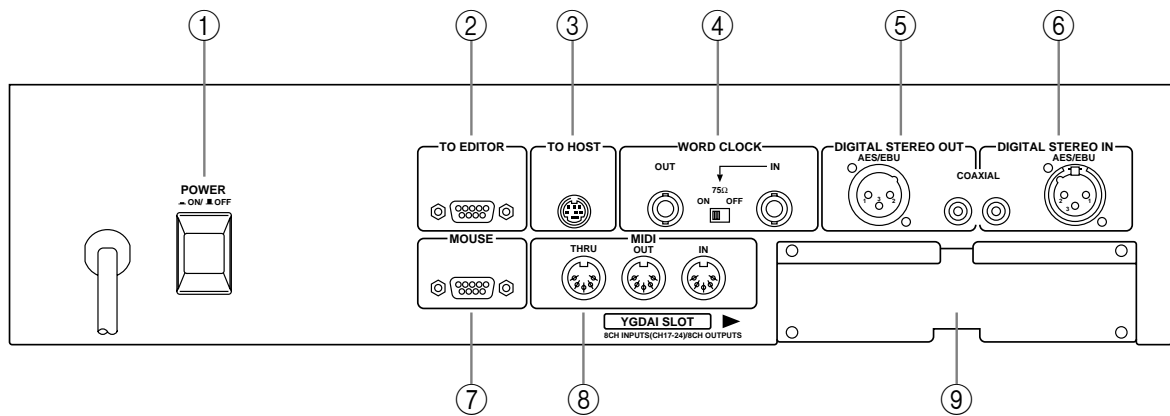

① **POWER switch**

This switch is used to turn on and off the 03D. It's recessed to prevent accidental operation.

② **TO EDITOR**

This 9-pin D-sub connector is used to connect the 03D to video-edit controllers. With the current version of the 03D system software, however, this function is not yet available.

③ **TO HOST**

This 8-pin mini DIN connector is used to connect the 03D to a personal computer for use with MIDI software. It eliminates the need for a separate MIDI interface, and together with the MIDI standard connections allows the 03D to be used as a MIDI interface for other MIDI equipment.

④ **WORD CLOCK**

These BNC connectors are used to input and output the system's wordclock. The 75Ω wordclock termination switch allows the 03D to be used with various wordclock wiring schemes. See Wordclock Setup on page 216.

⑤ **DIGITAL STEREO OUT**

These two connectors are digital stereo outputs. They output the same digital audio signal but in different formats. The XLR-3-32-type connector outputs AES/EBU format digital audio (24 bit), while the COAXIAL connector outputs Consumer format digital audio (20 bit).

⑥ **DIGITAL STEREO IN**

These two connectors are digital stereo inputs, and only one connection can be used at a time. The XLR-3-31-type connector accepts AES/EBU format digital audio, while the COAXIAL connector accepts Consumer format digital audio. Signals input here can be fed to the stereo input channel or directly to the Stereo bus for stereo cascade operation.

⑦ **MOUSE**

An optional PC-compatible serial mouse can be connected here for quick navigation and parameter editing.

⑧ **MIDI IN, OUT, THRU**

These are standard MIDI IN, OUT, and THRU connections. They are used to connect the 03D to other MIDI equipment for control and synchronization.

⑨ **YGDAI slot**

An optional YGDAI card can be installed here, providing access to the 03D's eight digital inputs and outputs. See YGDAI Cards on page 223.

Block Diagram

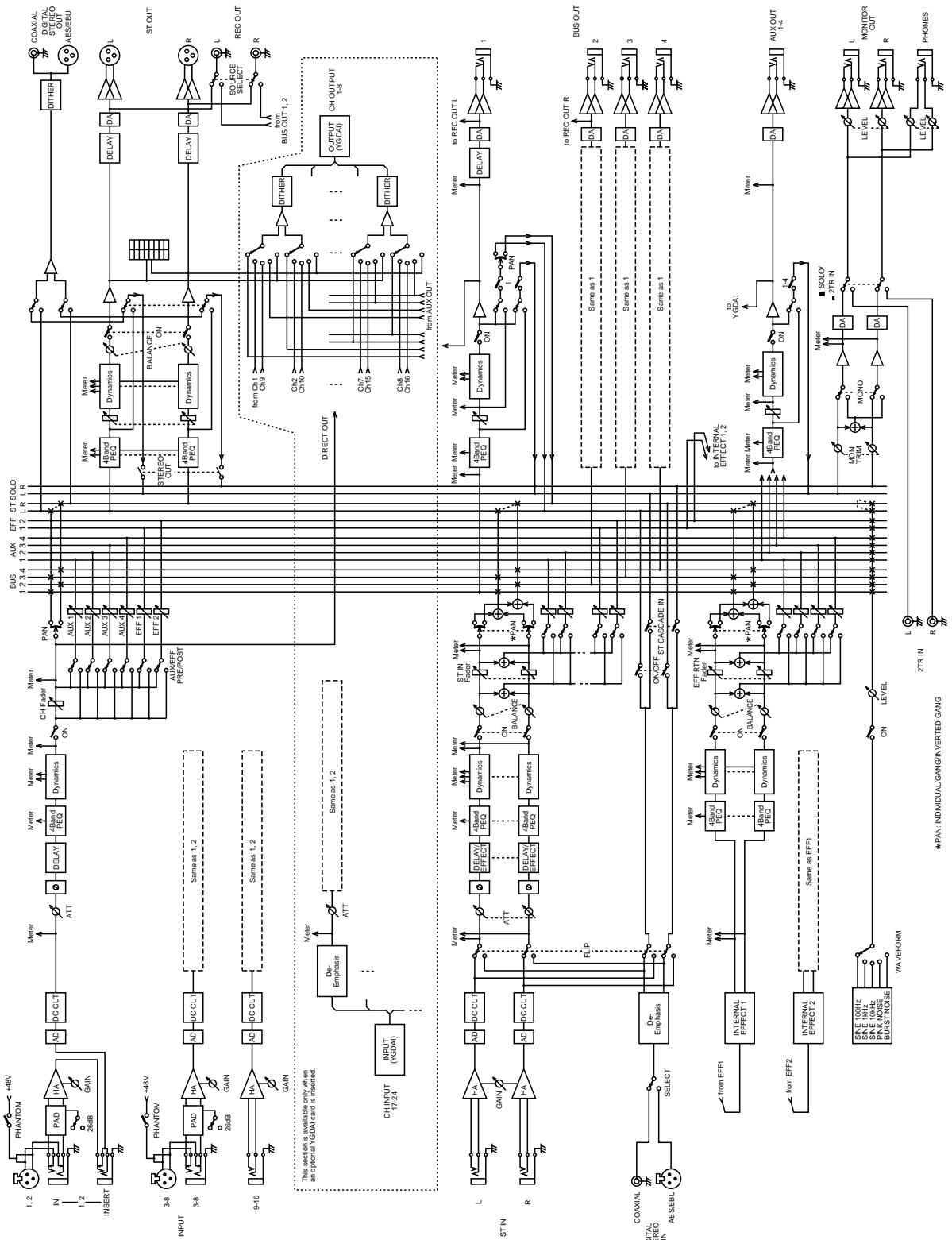

Getting Around the User Interface

3



In this chapter...

About the User Interface	24
Display	24
Display Elements	28
Cursor Buttons	29
PARAMETER Wheel	29
ENTER Button	29
Mouse	30
Mixing Layer	31
Title Edit Dialog Box	33

About the User Interface

The 03D user interface is both straightforward and easy to use. Apart from the GAIN controls, [PAD] switches, scene memory buttons, and a few other buttons, there are very few dedicated controls. The faders, [ON] buttons, and [SEL] buttons are multi-function controls whose operation depends on the Mixing Layer and fader mode settings. Mixing functions and configuration settings are organized into display pages, with up to five related pages being grouped together. For example, digital input and cascade pages are grouped together under DIO (digital I/O). Parameter selection and editing is carried out using the [CURSOR] buttons, [ENTER] button, and PARAMETER wheel, which is detented for precise and accurate editing. An optional mouse can be connected for quick navigation around the display and parameter setting.

Display

The large 320 x 240 dot display with fluorescent backlight provides clear indication of mix settings and operating status. As well as showing parameter values numerically, faders and rotary controls are represented graphically, so you can actually see pan and fader positions. The display also shows EQ curves and provides signal level meters.

The following illustration highlights the different areas of the display. These areas are explained below.

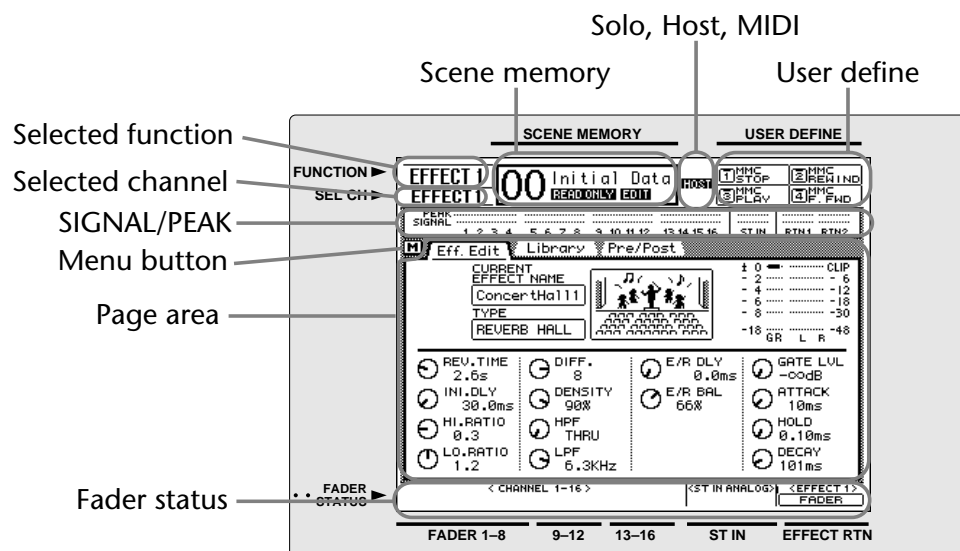

Scene memory—This area of the display shows the selected scene memory number and title, whether or not the scene memory is read-only or protected, and whether or not the contents of the Edit Buffer have been edited. See Scene Memory Display Area on page 165 for more information.

Solo, Host, MIDI—Three indicators share this area of the display: SOLO appears when the SOLO mode is active (*Using Solo* on page 76). HOST appears when data is received at the TO HOST connection. MIDI appears when data is received at the MIDI IN connection (*MIDI & TO HOST Data Receive Indicators* on page 233).

User define—This area of the display shows the functions assigned to the USER DEFINE buttons. See User Define Buttons on page 208 for more information.

Selected function—This area of the display shows the name of the function selected using the Setup, Channel Control, and Fader mode buttons. The following functions can be selected.

Setup	Channel Control	Fader Mode
SCENE MEMORY	DELAY/∅	AUX 1
UTILITY	DYNAMICS	AUX 2
MIDI	PAN/ROUTING	AUX 3
DIO	VIEW	AUX 4
GROUP/PAIR	EQ LOW	FADER (METER)
SOLO SETUP	LO-MID	EFFECT 1
AUTOMIX	HI-MID	EFFECT 2
MIDI REMOTE	HIGH	—

Selected channel—This area of the display shows the selected channel. When channels are configured as a stereo pair, the number of each channel separated by a dash is shown (e.g., 1–2 or 17–18). The following channels can be selected.

CH 1	CH 2	CH 3	CH 4	CH 5	CH 6	CH 7	CH 8
CH 9	CH 10	CH 11	CH 12	CH 13	CH 14	CH 15	CH 16
CH 17	CH 18	CH 19	CH 20	CH 21	CH 22	CH 23	CH 24
AUX 1	AUX 2	AUX 3	AUX 4	BUS 1	BUS 2	BUS 3	BUS 4
ST IN	EFFECT 1	EFFECT 2	ST OUT	—	—	—	—

When automix is operating, its status is displayed.

SIGNAL/PEAK—This area of the display always contains the SIGNAL and PEAK level indicators. The SIGNAL indicator lights up when the signal level is at –24 dB, and is intended to show that a signal is present. The PEAK indicator lights up when the signal is at –3 dB. These indicators are affected by the Mixing Layer setting. When the Mixing Layer is set to 1–16, the following channels are metered.

PEAK																ST IN	RTN1	RTN2
SIGNAL	1	2	3	4	5	6	7	8	9	10	11	12	13	14	15	16			

CH 1	CH 2	CH 3	CH 4	CH 5	CH 6	CH 7	CH 8
CH 9	CH 10	CH 11	CH 12	CH 13	CH 14	CH 15	CH 16
ST IN	RTN 1	RTN 2	—	—	—	—	—

When the Mixing Layer is set to 17–24/MASTER, the following channels are metered.

PEAK																ST IN	RTN1	RTN2
SIGNAL	17	18	19	20	21	22	23	24	AUX1	2	3	4	BUS1	2	3	4			

CH 17	CH 18	CH 19	CH 20	CH 21	CH 22	CH 23	CH 24
AUX 1	AUX 2	AUX 3	AUX 4	BUS 1	BUS 2	BUS 3	BUS 4
ST IN	RTN 1	RTN 2	—	—	—	—	—

Menu button—The Menu button is used in conjunction with a mouse to access the Menu Function. See Function Menu on page 30 for more information.

Page area—This area of the display is where the various setup, configuration, and mixing function pages appear. As well as showing parameter values numerically, faders and rotary controls are represented graphically, so you can actually see pan and fader

positions. See Display Elements on page 28 for more information. An example page is shown below.

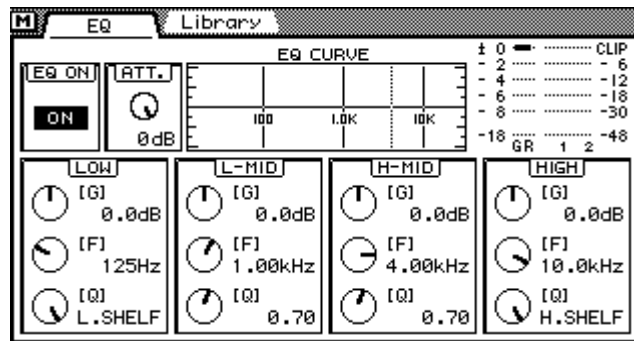



The title of each page appears in a tab at the top of each page. The tab of the selected page has a dark border, as shown below. Pages can be selected simply by clicking the tabs with the mouse.







Selected page



Fader status—This area of the display shows the selected fader mode and Mixing Layer. The top row indicates which channel the fader is controlling (e.g., channel 1), and the bottom row indicates which signal of that channel the fader is controlling (e.g., AUX 1 SEND). The following two tables show what is displayed for the various fader modes and Mixing Layer settings.

Mixing Layer 1–16											
<p>FADER</p> <p>METER</p>	<table border="1"> <tr> <td colspan="3">< CHANNEL 1–16 > FADER</td> <td><ST IN ANALOG> FADER</td> <td><EFFECT 1> FADER</td> </tr> <tr> <td>FADER 1–8</td> <td>9–12</td> <td>13–16</td> <td>ST IN</td> <td>EFFECT RTN</td> </tr> </table>	< CHANNEL 1–16 > FADER			<ST IN ANALOG> FADER	<EFFECT 1> FADER	FADER 1–8	9–12	13–16	ST IN	EFFECT RTN
< CHANNEL 1–16 > FADER			<ST IN ANALOG> FADER	<EFFECT 1> FADER							
FADER 1–8	9–12	13–16	ST IN	EFFECT RTN							
<p>AUX 1</p>	<table border="1"> <tr> <td colspan="3">< CHANNEL 1–16 > AUX1 SEND</td> <td><ST IN ANALOG> AUX1 SEND</td> <td><EFFECT 1> AUX1 SEND</td> </tr> <tr> <td>FADER 1–8</td> <td>9–12</td> <td>13–16</td> <td>ST IN</td> <td>EFFECT RTN</td> </tr> </table>	< CHANNEL 1–16 > AUX1 SEND			<ST IN ANALOG> AUX1 SEND	<EFFECT 1> AUX1 SEND	FADER 1–8	9–12	13–16	ST IN	EFFECT RTN
< CHANNEL 1–16 > AUX1 SEND			<ST IN ANALOG> AUX1 SEND	<EFFECT 1> AUX1 SEND							
FADER 1–8	9–12	13–16	ST IN	EFFECT RTN							
<p>AUX 2</p>	<table border="1"> <tr> <td colspan="3">< CHANNEL 1–16 > AUX2 SEND</td> <td><ST IN ANALOG> AUX2 SEND</td> <td><EFFECT 1> AUX2 SEND</td> </tr> <tr> <td>FADER 1–8</td> <td>9–12</td> <td>13–16</td> <td>ST IN</td> <td>EFFECT RTN</td> </tr> </table>	< CHANNEL 1–16 > AUX2 SEND			<ST IN ANALOG> AUX2 SEND	<EFFECT 1> AUX2 SEND	FADER 1–8	9–12	13–16	ST IN	EFFECT RTN
< CHANNEL 1–16 > AUX2 SEND			<ST IN ANALOG> AUX2 SEND	<EFFECT 1> AUX2 SEND							
FADER 1–8	9–12	13–16	ST IN	EFFECT RTN							
<p>AUX 3</p>	<table border="1"> <tr> <td colspan="3">< CHANNEL 1–16 > AUX3 SEND</td> <td><ST IN ANALOG> AUX3 SEND</td> <td><EFFECT 1> AUX3 SEND</td> </tr> <tr> <td>FADER 1–8</td> <td>9–12</td> <td>13–16</td> <td>ST IN</td> <td>EFFECT RTN</td> </tr> </table>	< CHANNEL 1–16 > AUX3 SEND			<ST IN ANALOG> AUX3 SEND	<EFFECT 1> AUX3 SEND	FADER 1–8	9–12	13–16	ST IN	EFFECT RTN
< CHANNEL 1–16 > AUX3 SEND			<ST IN ANALOG> AUX3 SEND	<EFFECT 1> AUX3 SEND							
FADER 1–8	9–12	13–16	ST IN	EFFECT RTN							
<p>AUX 4</p>	<table border="1"> <tr> <td colspan="3">< CHANNEL 1–16 > AUX4 SEND</td> <td><ST IN ANALOG> AUX4 SEND</td> <td><EFFECT 1> AUX4 SEND</td> </tr> <tr> <td>FADER 1–8</td> <td>9–12</td> <td>13–16</td> <td>ST IN</td> <td>EFFECT RTN</td> </tr> </table>	< CHANNEL 1–16 > AUX4 SEND			<ST IN ANALOG> AUX4 SEND	<EFFECT 1> AUX4 SEND	FADER 1–8	9–12	13–16	ST IN	EFFECT RTN
< CHANNEL 1–16 > AUX4 SEND			<ST IN ANALOG> AUX4 SEND	<EFFECT 1> AUX4 SEND							
FADER 1–8	9–12	13–16	ST IN	EFFECT RTN							

Mixing Layer 1-16													
EFFECT 1 	<table border="1" style="width: 100%; border-collapse: collapse;"> <tr> <td style="text-align: center;">< CHANNEL 1-16 ></td> <td style="text-align: center;"><ST IN ANALOG></td> <td style="text-align: center;">< EFFECT 1 ></td> </tr> <tr> <td style="text-align: center;">EFF1 SEND</td> <td style="text-align: center;">EFF1 SEND</td> <td style="text-align: center;">FADER</td> </tr> <tr> <td style="text-align: center;">FADER 1-8</td> <td style="text-align: center;">9-12</td> <td style="text-align: center;">13-16</td> </tr> <tr> <td></td> <td style="text-align: center;">ST IN</td> <td style="text-align: center;">EFFECT RTN</td> </tr> </table>	< CHANNEL 1-16 >	<ST IN ANALOG>	< EFFECT 1 >	EFF1 SEND	EFF1 SEND	FADER	FADER 1-8	9-12	13-16		ST IN	EFFECT RTN
< CHANNEL 1-16 >	<ST IN ANALOG>	< EFFECT 1 >											
EFF1 SEND	EFF1 SEND	FADER											
FADER 1-8	9-12	13-16											
	ST IN	EFFECT RTN											
EFFECT 2 	<table border="1" style="width: 100%; border-collapse: collapse;"> <tr> <td style="text-align: center;">< CHANNEL 1-16 ></td> <td style="text-align: center;"><ST IN ANALOG></td> <td style="text-align: center;">< EFFECT 2 ></td> </tr> <tr> <td style="text-align: center;">EFF2 SEND</td> <td style="text-align: center;">EFF2 SEND</td> <td style="text-align: center;">FADER</td> </tr> <tr> <td style="text-align: center;">FADER 1-8</td> <td style="text-align: center;">9-12</td> <td style="text-align: center;">13-16</td> </tr> <tr> <td></td> <td style="text-align: center;">ST IN</td> <td style="text-align: center;">EFFECT RTN</td> </tr> </table>	< CHANNEL 1-16 >	<ST IN ANALOG>	< EFFECT 2 >	EFF2 SEND	EFF2 SEND	FADER	FADER 1-8	9-12	13-16		ST IN	EFFECT RTN
< CHANNEL 1-16 >	<ST IN ANALOG>	< EFFECT 2 >											
EFF2 SEND	EFF2 SEND	FADER											
FADER 1-8	9-12	13-16											
	ST IN	EFFECT RTN											

Mixing Layer 17-24/MASTER																
FADER  METER	<table border="1" style="width: 100%; border-collapse: collapse;"> <tr> <td style="text-align: center;">< CHANNEL 17-24 ></td> <td style="text-align: center;"><AUX 1-4></td> <td style="text-align: center;"><BUS 1-4></td> <td style="text-align: center;"><ST IN ANALOG></td> <td style="text-align: center;">< EFFECT 2 ></td> </tr> <tr> <td style="text-align: center;">FADER</td> <td style="text-align: center;">MASTER</td> <td style="text-align: center;">MASTER</td> <td style="text-align: center;">FADER</td> <td style="text-align: center;">FADER</td> </tr> <tr> <td style="text-align: center;">FADER 1-8</td> <td style="text-align: center;">9-12</td> <td style="text-align: center;">13-16</td> <td style="text-align: center;">ST IN</td> <td style="text-align: center;">EFFECT RTN</td> </tr> </table>	< CHANNEL 17-24 >	<AUX 1-4>	<BUS 1-4>	<ST IN ANALOG>	< EFFECT 2 >	FADER	MASTER	MASTER	FADER	FADER	FADER 1-8	9-12	13-16	ST IN	EFFECT RTN
< CHANNEL 17-24 >	<AUX 1-4>	<BUS 1-4>	<ST IN ANALOG>	< EFFECT 2 >												
FADER	MASTER	MASTER	FADER	FADER												
FADER 1-8	9-12	13-16	ST IN	EFFECT RTN												
AUX 1 	<table border="1" style="width: 100%; border-collapse: collapse;"> <tr> <td style="text-align: center;">< CHANNEL 17-24 ></td> <td style="text-align: center;"><AUX 1-4></td> <td style="text-align: center;"><BUS 1-4></td> <td style="text-align: center;"><ST IN ANALOG></td> <td style="text-align: center;">< EFFECT 2 ></td> </tr> <tr> <td style="text-align: center;">AUX1 SEND</td> <td style="text-align: center;">MASTER</td> <td style="text-align: center;">MASTER</td> <td style="text-align: center;">AUX1 SEND</td> <td style="text-align: center;">AUX1 SEND</td> </tr> <tr> <td style="text-align: center;">FADER 1-8</td> <td style="text-align: center;">9-12</td> <td style="text-align: center;">13-16</td> <td style="text-align: center;">ST IN</td> <td style="text-align: center;">EFFECT RTN</td> </tr> </table>	< CHANNEL 17-24 >	<AUX 1-4>	<BUS 1-4>	<ST IN ANALOG>	< EFFECT 2 >	AUX1 SEND	MASTER	MASTER	AUX1 SEND	AUX1 SEND	FADER 1-8	9-12	13-16	ST IN	EFFECT RTN
< CHANNEL 17-24 >	<AUX 1-4>	<BUS 1-4>	<ST IN ANALOG>	< EFFECT 2 >												
AUX1 SEND	MASTER	MASTER	AUX1 SEND	AUX1 SEND												
FADER 1-8	9-12	13-16	ST IN	EFFECT RTN												
AUX 2 	<table border="1" style="width: 100%; border-collapse: collapse;"> <tr> <td style="text-align: center;">< CHANNEL 17-24 ></td> <td style="text-align: center;"><AUX 1-4></td> <td style="text-align: center;"><BUS 1-4></td> <td style="text-align: center;"><ST IN ANALOG></td> <td style="text-align: center;">< EFFECT 2 ></td> </tr> <tr> <td style="text-align: center;">AUX2 SEND</td> <td style="text-align: center;">MASTER</td> <td style="text-align: center;">MASTER</td> <td style="text-align: center;">AUX2 SEND</td> <td style="text-align: center;">AUX2 SEND</td> </tr> <tr> <td style="text-align: center;">FADER 1-8</td> <td style="text-align: center;">9-12</td> <td style="text-align: center;">13-16</td> <td style="text-align: center;">ST IN</td> <td style="text-align: center;">EFFECT RTN</td> </tr> </table>	< CHANNEL 17-24 >	<AUX 1-4>	<BUS 1-4>	<ST IN ANALOG>	< EFFECT 2 >	AUX2 SEND	MASTER	MASTER	AUX2 SEND	AUX2 SEND	FADER 1-8	9-12	13-16	ST IN	EFFECT RTN
< CHANNEL 17-24 >	<AUX 1-4>	<BUS 1-4>	<ST IN ANALOG>	< EFFECT 2 >												
AUX2 SEND	MASTER	MASTER	AUX2 SEND	AUX2 SEND												
FADER 1-8	9-12	13-16	ST IN	EFFECT RTN												
AUX 3 	<table border="1" style="width: 100%; border-collapse: collapse;"> <tr> <td style="text-align: center;">< CHANNEL 17-24 ></td> <td style="text-align: center;"><AUX 1-4></td> <td style="text-align: center;"><BUS 1-4></td> <td style="text-align: center;"><ST IN ANALOG></td> <td style="text-align: center;">< EFFECT 2 ></td> </tr> <tr> <td style="text-align: center;">AUX3 SEND</td> <td style="text-align: center;">MASTER</td> <td style="text-align: center;">MASTER</td> <td style="text-align: center;">AUX3 SEND</td> <td style="text-align: center;">AUX3 SEND</td> </tr> <tr> <td style="text-align: center;">FADER 1-8</td> <td style="text-align: center;">9-12</td> <td style="text-align: center;">13-16</td> <td style="text-align: center;">ST IN</td> <td style="text-align: center;">EFFECT RTN</td> </tr> </table>	< CHANNEL 17-24 >	<AUX 1-4>	<BUS 1-4>	<ST IN ANALOG>	< EFFECT 2 >	AUX3 SEND	MASTER	MASTER	AUX3 SEND	AUX3 SEND	FADER 1-8	9-12	13-16	ST IN	EFFECT RTN
< CHANNEL 17-24 >	<AUX 1-4>	<BUS 1-4>	<ST IN ANALOG>	< EFFECT 2 >												
AUX3 SEND	MASTER	MASTER	AUX3 SEND	AUX3 SEND												
FADER 1-8	9-12	13-16	ST IN	EFFECT RTN												
AUX 4 	<table border="1" style="width: 100%; border-collapse: collapse;"> <tr> <td style="text-align: center;">< CHANNEL 17-24 ></td> <td style="text-align: center;"><AUX 1-4></td> <td style="text-align: center;"><BUS 1-4></td> <td style="text-align: center;"><ST IN ANALOG></td> <td style="text-align: center;">< EFFECT 2 ></td> </tr> <tr> <td style="text-align: center;">AUX4 SEND</td> <td style="text-align: center;">MASTER</td> <td style="text-align: center;">MASTER</td> <td style="text-align: center;">AUX4 SEND</td> <td style="text-align: center;">AUX4 SEND</td> </tr> <tr> <td style="text-align: center;">FADER 1-8</td> <td style="text-align: center;">9-12</td> <td style="text-align: center;">13-16</td> <td style="text-align: center;">ST IN</td> <td style="text-align: center;">EFFECT RTN</td> </tr> </table>	< CHANNEL 17-24 >	<AUX 1-4>	<BUS 1-4>	<ST IN ANALOG>	< EFFECT 2 >	AUX4 SEND	MASTER	MASTER	AUX4 SEND	AUX4 SEND	FADER 1-8	9-12	13-16	ST IN	EFFECT RTN
< CHANNEL 17-24 >	<AUX 1-4>	<BUS 1-4>	<ST IN ANALOG>	< EFFECT 2 >												
AUX4 SEND	MASTER	MASTER	AUX4 SEND	AUX4 SEND												
FADER 1-8	9-12	13-16	ST IN	EFFECT RTN												
EFFECT 1 	<table border="1" style="width: 100%; border-collapse: collapse;"> <tr> <td style="text-align: center;">< CHANNEL 17-24 ></td> <td style="text-align: center;"><AUX 1-4></td> <td style="text-align: center;"><BUS 1-4></td> <td style="text-align: center;"><ST IN ANALOG></td> <td style="text-align: center;">< EFFECT 1 ></td> </tr> <tr> <td style="text-align: center;">EFF1 SEND</td> <td style="text-align: center;">MASTER</td> <td style="text-align: center;">MASTER</td> <td style="text-align: center;">EFF1 SEND</td> <td style="text-align: center;">FADER</td> </tr> <tr> <td style="text-align: center;">FADER 1-8</td> <td style="text-align: center;">9-12</td> <td style="text-align: center;">13-16</td> <td style="text-align: center;">ST IN</td> <td style="text-align: center;">EFFECT RTN</td> </tr> </table>	< CHANNEL 17-24 >	<AUX 1-4>	<BUS 1-4>	<ST IN ANALOG>	< EFFECT 1 >	EFF1 SEND	MASTER	MASTER	EFF1 SEND	FADER	FADER 1-8	9-12	13-16	ST IN	EFFECT RTN
< CHANNEL 17-24 >	<AUX 1-4>	<BUS 1-4>	<ST IN ANALOG>	< EFFECT 1 >												
EFF1 SEND	MASTER	MASTER	EFF1 SEND	FADER												
FADER 1-8	9-12	13-16	ST IN	EFFECT RTN												
EFFECT 2 	<table border="1" style="width: 100%; border-collapse: collapse;"> <tr> <td style="text-align: center;">< CHANNEL 17-24 ></td> <td style="text-align: center;"><AUX 1-4></td> <td style="text-align: center;"><BUS 1-4></td> <td style="text-align: center;"><ST IN ANALOG></td> <td style="text-align: center;">< EFFECT 2 ></td> </tr> <tr> <td style="text-align: center;">EFF2 SEND</td> <td style="text-align: center;">MASTER</td> <td style="text-align: center;">MASTER</td> <td style="text-align: center;">EFF2 SEND</td> <td style="text-align: center;">FADER</td> </tr> <tr> <td style="text-align: center;">FADER 1-8</td> <td style="text-align: center;">9-12</td> <td style="text-align: center;">13-16</td> <td style="text-align: center;">ST IN</td> <td style="text-align: center;">EFFECT RTN</td> </tr> </table>	< CHANNEL 17-24 >	<AUX 1-4>	<BUS 1-4>	<ST IN ANALOG>	< EFFECT 2 >	EFF2 SEND	MASTER	MASTER	EFF2 SEND	FADER	FADER 1-8	9-12	13-16	ST IN	EFFECT RTN
< CHANNEL 17-24 >	<AUX 1-4>	<BUS 1-4>	<ST IN ANALOG>	< EFFECT 2 >												
EFF2 SEND	MASTER	MASTER	EFF2 SEND	FADER												
FADER 1-8	9-12	13-16	ST IN	EFFECT RTN												

Display Elements

This section explains the various elements that appear on display pages.

Switches

Switches appear as boxes with a shadowed outline (i.e., a thicker outline on the right side and bottom of the box).



Simple on/off-type switches are highlighted when they are turned on. In this example, the [1] and [ST] switches are on.



The labels inside some switches change when they are turned on or off, as these Normal and Reverse phase switches show.



For option-type switches, only one option can be chosen. In this example, the wordclock source is set to INT 48K.



To operate a switch, use the cursor buttons to select it and the [ENTER] button to turn it on or off. With a mouse, position the mouse cursor over the switch and click.

Rotary Controls

Parameters with a variable range appear as rotary controls, as this example from the EQ page shows. To adjust a rotary control, use the cursor buttons to select the control and the PARAMETER wheel to adjust the value. To adjust a rotary control using a mouse, position the mouse cursor over the control, press and hold the left mouse button, and then drag the mouse. Parameters with a wide range, such as effects delay times, can be adjusted much quicker by holding down the right mouse button and dragging. Rotary controls can also be adjusted in single-step increments by clicking once with a mouse. Clicking with the left mouse button decreases a value; clicking with the right button increases it.

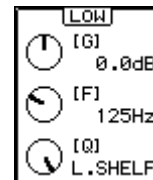

Faders

Some pages, such as the CH View page, display faders graphically. Usually, faders are adjusted using the real faders. But they can also be adjusted using the PARAMETER wheel or a mouse. To adjust a fader using the PARAMETER wheel, use the cursor buttons to select the fader and the PARAMETER wheel to adjust it. To adjust a fader using a mouse, position the mouse cursor over the fader, press and hold the left mouse button, and then drag the mouse. Fader knobs appear highlighted when set to the nominal position. Faders can also be adjusted in single-step increments by clicking once with a mouse. Clicking with the left mouse button lowers the fader; clicking with the right button raises it.

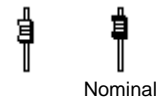

Parameter Boxes

Parameters that appear in parameter boxes (i.e., dotted-line boxes) can be set using the PARAMETER wheel or a mouse. Use the cursor buttons to select the parameter box and the PARAMETER wheel to adjust. If you are using a mouse, position the mouse cursor over the parameter box, press and hold the left mouse button, and then drag the mouse. Parameter boxes can also be adjusted in single-step increments by clicking once with a mouse. Clicking with the left mouse button scrolls down one step; clicking with the right mouse button scrolls up one step.

06.Comfander(S)	READ ONLY
05.Comfander(H)	READ ONLY
04.Duck ins	READ ONLY
03.Expand	READ ONLY
02.Gate	READ ONLY
01.CompF	READ ONLY

Cursor Buttons

The cursor buttons are used to move the cursor around the display pages, selecting parameters and options. The cursor appears as a flashing box, making it easy to see which parameter or option is currently selected. Holding down a cursor button moves the cursor continuously in the respective direction.

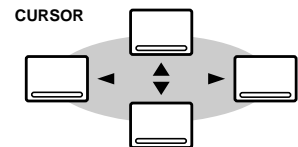

PARAMETER Wheel

The PARAMETER wheel is used to adjust parameter values, scroll through scene memory and library programs, and position the cursor when titling scene memories, effects programs, and so on. Its detented action gives it a positive feel, allowing quick and accurate parameter editing. Turning it clockwise increases parameter values; turning it counterclockwise decreases them. Turning it fast allows rapid parameter editing.

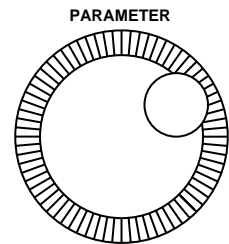

ENTER Button

The [ENTER] button is used to activate parameter settings chosen using the [CURSOR] buttons, and set on/off-type parameters, such as EQ ON/OFF. It's also used to confirm settings and enter characters when titling scene memories, effects programs, and so on. On some pages, such as the EQ page, the [ENTER] button is used solely to turn the EQ on and off.



Mouse

An optional mouse can be connected to the 03D for quick navigation around the display and parameter setting. Simple on/off-type parameters can then be set with one click of the mouse, and rotary controls can be dragged. The 03D should work with any PC-compatible serial mouse (a mouse that supports both serial and PS-2 operation may not work correctly with the 03D). The mouse should be connected to the MOUSE connector on the 03D's rear panel. The mouse speed can be set to one of four speeds on the Prefer. page of the Utility function. See MOUSE SPEED on page 213 for more information.

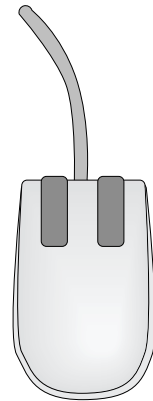

Most mouse operations can be performed using either the left or right mouse button. Some parameters that have a wide range, such as effects delay times, can be adjusted much quicker by holding down the right mouse button and dragging. In this case, the left mouse button works like a fine adjust control, while the right mouse button works as a coarse adjust control. Parameters can also be adjusted in single-step increments by clicking once with the mouse. Clicking with the left mouse button decreases a value; clicking with the right button increases it.

Display pages within the currently selected group can be selected simply by clicking on page-title tabs, as shown below.

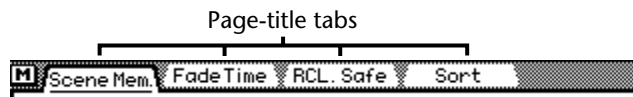

Function Menu

When a mouse is connected to the 03D, the Function Menu shown below can be used to access MIDI Remote, Setup, Channel Control, and Fader Mode pages. The Function Menu is accessed by clicking the M (Menu) button to the left of the page-title tabs, as shown below. If the mouse is disconnected, the mouse cursor disappears after about five minutes.

Click here to access the Function Menu

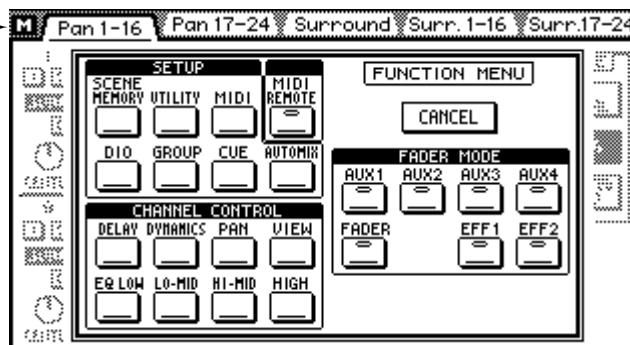

The Function menu disappears after 10 seconds if no switches are clicked.

Mixing Layer

The 03D [SEL] buttons, [ON] buttons, and faders are multifunction controls. Their exact operation depends on the selected Mixing Layer. Fader operation is also affected by the Fader modes. The operation of all these controls is shown in the following tables. As these tables show, the ST IN, EFFECT RETURN, and ST OUT [SEL] buttons, [ON] buttons, and faders are unaffected by the Mixing Layer setting.

SEL Buttons

Mixing Layer	SEL button					
	1–8	9–12	13–16	ST IN	EFF RTN	ST OUT
1–16	CH 1–8 select	CH 9–12 select	CH 13–16 select	ST IN select	¹ EFF RTN 1/2 select	ST OUT select
17–24/ MASTER	CH 17–24 select	AUX 1–4 Master select	BUS 1–4 Master select			

1. During automix recording, the EFFECT RETURN [SEL] button is used to turn effect editing on and off. In this case, the [EFFECT 1] and [EFFECT 2] buttons should be used to select Effect 1 and Effect 2.

With automix, [SEL] buttons are used to select channels for recording. See Automix on page 175 for more information. [SEL] buttons are also used to select channels for the fader and mute groups. See Groups & Pairs on page 111 for more information.

ON Buttons

Mixing Layer	ON button					
	1–8	9–12	13–16	ST IN	EFF RTN	ST OUT
1–16	CH 1–8 On/Off	CH 9–12 On/Off	CH 13–16 On/Off	ST IN On/Off	EFF RTN 1/2 On/Off	ST OUT On/Off
17–24/ MASTER	CH 17–24 On/Off	AUX 1–4 Master On/Off	BUS 1–4 Master On/Off			

When the [SOLO] function is on, input channels 1 to 24, the stereo input channel, and effects returns channel's [ON] buttons work as solo buttons, not mute buttons.

[ON] button operation is different in MIDI Remote mode. See MIDI Remote on page 243 for more information.

Faders

Mixing Layer: 1–16

Fader Mode	Fader					
	1–8	9–12	13–16	ST IN	EFF RTN	ST OUT
Fader (Meter)	CH 1–8 fader	CH 9–12 fader	CH 13–16 fader	ST IN fader	EFF RTN 1/2 fader	ST OUT Master fader
Aux 1	CH 1–8 AUX 1 send	CH 9–12 AUX 1 send	CH 13–16 AUX 1 send	ST IN AUX 1 send	EFF RTN 1/2 AUX 1 send	
Aux 2	CH 1–8 AUX 2 send	CH 9–12 AUX 2 send	CH 13–16 AUX 2 send	ST IN AUX 2 send	EFF RTN 1/2 AUX 2 send	
Aux 3	CH 1–8 AUX 3 send	CH 9–12 AUX 3 send	CH 13–16 AUX 3 send	ST IN AUX 3 send	EFF RTN 1/2 AUX 3 send	
Aux 4	CH 1–8 AUX 4 send	CH 9–12 AUX 4 send	CH 13–16 AUX 4 send	ST IN AUX 4 send	EFF RTN 1/2 AUX 4 send	
Effect 1	CH 1–8 Eff 1 send	CH 9–12 Eff 1 send	CH 13–16 Eff 1 send	ST IN Eff 1 send	EFF RTN 1 fader	
Effect 2	CH 1–8 Eff 2 send	CH 9–12 Eff 2 send	CH 13–16 Eff 2 send	ST IN Eff 2 send	EFF RTN 2 fader	

Mixing Layer: 17–24/MASTER

Fader Mode	Fader					
	1–8	9–12	13–16	ST IN	EFF RTN	ST OUT
Fader (Meter)	CH 17–24 fader	Aux 1–4 Master fader	Bus 1–4 Master fader	Same as Mixing Layer 1–16		
Aux 1	CH 17–24 AUX 1 send					
Aux 2	CH 17–24 AUX 2 send					
Aux 3	CH 17–24 AUX 3 send					
Aux 4	CH 17–24 AUX 4 send					
Effect 1	CH 17–24 Eff 1 send					
Effect 2	CH 17–24 Eff 2 send					

Fader operation is different in MIDI Remote mode. See MIDI Remote on page 243 for more information.

Title Edit Dialog Box

The Title Edit dialog box is used to title mix scenes, EQ programs, dynamics programs, effects programs, channel programs, and automixes. It appears when storing or retitling a scene memory or program. Titles can be up to 12 characters long. Available characters are shown on the following two screen shots. The SPC key is a space key.

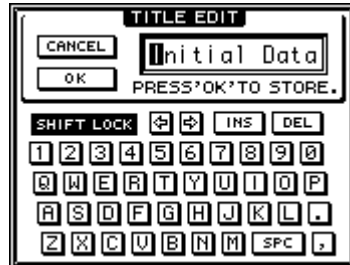

SHIFT LOCK = ON

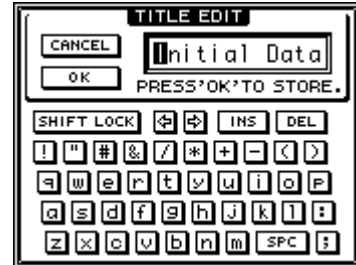

To position the cursor in the title, use the PARAMETER wheel or the arrow switches on the Title Edit dialog box. If you are using a mouse, simply click within the title.



To enter a character, use the cursor buttons to select a character, and then press the [ENTER] button. If you are using a mouse, simply click a character. To access the lowercase characters and various symbols, select the SHIFT LOCK switch and press the [ENTER] button. Press SHIFT LOCK again to access the uppercase characters and numbers.



Use the INS switch to insert a space at the cursor position and move subsequent characters to the right. Characters moved beyond the right side of the title window are lost.



Use the DEL switch to delete the character at the cursor position and move subsequent characters to the left.



When you've completed the title, select OK and press the [ENTER] button to continue, or select CANCEL and press the button [ENTER] to cancel the operation.

Input Channels

4

In this chapter...

Input Channel Overview	36
Phantom Power (input channels 1–8)	37
Pad (input channels 1–8)	37
Gain	37
Metering	37
Insert (input channels 1 & 2)	37
Attenuator	38
Phase	39
Channel Delay	40
Applying EQ to the Input Channels EQ	42
Dynamics Processor	42
Muting Input Channels (ON/OFF)	42
Setting Input Channel Levels	42
Pan, Balance & Routing	42
Direct Outputs	43
Aux Sends	43
Monitoring Input Channels	43
Input Channel Stereo Pairs	43
Input Channels Block Diagram	44

This chapter covers input channels 1 to 24 and the stereo input (ST IN). Unless otherwise stated, explanations refer to all of these inputs. The sections of this chapter are arranged in order of signal flow, from input connector through to bus.

Input Channel Overview

A full description of the rear panel connectors is provided on page 16.

Input Channels 1 & 2

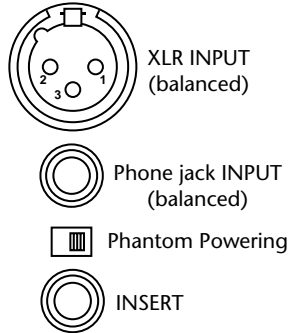

Input channels 1 and 2 feature balanced XLR-3-31-type and balanced phone jack connectors, both with a nominal input range of -60 dB to $+10$ dB. Individually switchable $+48$ V phantom powering is supplied to the XLR connector. The phone jack has priority over the XLR-type connector, so when a phone plug is inserted, the XLR-type connector is disconnected. The phone jack input can also be used with unbalanced phone plugs. A TRS phone jack provides a post-gain, pre-A/D-conversion insert point.

Input Channels 3 to 8

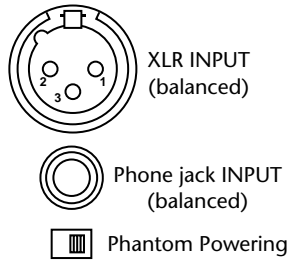

Input channels 3 to 8 are identical to input channels 1 & 2 except they do not have inserts.

Input Channels 9 to 16

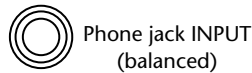

Input channels 9 to 16 are identical to input channels 1 to 2 except they do not have inserts, XLR inputs, or phantom powering.

Input Channels 17 to 24

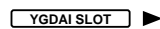

Input channels 17 to 24 are identical to input channels 9 to 16 except they do not have analog input connectors, a pad switch, gain control, or direct out. These input channels are accessed through the digital inputs of the YGDAI slot. See YGDAI Cards on page 223 for more information.

Stereo Input Channel (ST IN)

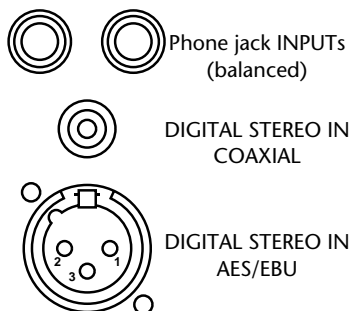

Apart from being stereo and having a balance control, the stereo input channel has the same features as the other input channels. One of three input sources can be selected for the stereo input channel: analog phone jacks, DIGITAL STEREO IN AES/EBU, or DIGITAL STEREO IN COAXIAL. Input selection is made on the D.in Setup page. See Digital Stereo In on page 221 for more information.

Phantom Power (input channels 1–8)



Input channels 1 to 8 feature switchable +48 V phantom powering for use with condenser-type microphones. Phantom powering is supplied to the balanced XLR-3-31-type connector, and can be switched individually for each channel. Phantom power should be turned on only when a condenser-type microphone is connected.

Pad (input channels 1–8)



Input channels 1 to 8 feature 26 dB pad switches. Input pads attenuate the input signal by 26 dB, allowing the input preamp to work with high-level signals. You may need to use a pad with “hot” signals from bass or snare drum microphones, or “hot” line-level signals. PAD switch settings are not stored in scene memories or channel programs, and cannot be controlled using automix.

Gain

GAIN controls adjust the gain of the input preamps. They are used to optimize the input signal level for the best signal-to-noise performance, and should be set in conjunction with the level meters. Ideally, the GAIN should be set so that the signal level is relatively high, and it’s okay for it to reach PEAK occasionally. If PEAK is reached often, however, back off the GAIN control a little, otherwise, signal distortion may occur. The GAIN control should be set with care. If it’s set too low, the signal-to-noise performance will suffer. If it’s set too high, unpleasant signal clipping and distortion may occur.



The GAIN controls on input channels 1 to 8 are designed for use with microphone signals, and have an input sensitivity of –16 dB to –60 dB. Used in conjunction with the 26 dB PAD switches, however, these channels can also be used with line-level signals and “hot” microphone signals. With the pad switch on, the input sensitivity is +10 to –34 dB.



The GAIN controls on input channels 9 to 16 and the stereo input (ST IN) are designed for use with line-level signals, and have a gain range of –10 dB to 20 dB.

GAIN control settings are not stored in scene memories or channel programs, and cannot be controlled using automix. GAIN controls are, however, detented for accurate repeat setting. The stereo input channel’s GAIN control is not detented.

Metering

Signal levels can be metered on the Meter pages. See Metering on page 79 for more information.

Insert (input channels 1 & 2)



Input channels 1 and 2 feature post-gain, pre-A/D-conversion insert points via TRS phone jacks. These allow you to patch in your favorite external signal processors for exclusive use with input channels 1 and 2. Typically, compressors, limiters, and noise gates are connected to this type of connection. The insert jacks are wired: sleeve–ground, ring–return, tip–send. A wiring diagram for an insert cable is provided on page 17.

Attenuator

After A/D conversion, input signals can be attenuated using the Attenuation function. Signals can be attenuated from 0 dB to -96 dB in 1 dB steps. For digital inputs 17 to 24, the Attenuation function comes after de-emphasis. Attenuation is set on the EQ page.

1. Press the [EQ LOW] button to locate the EQ page shown below.

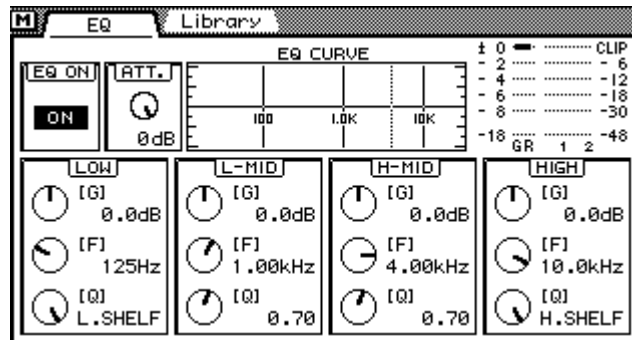

2. Use the [SEL] and [MIXING LAYER] buttons to select a channel. See *Mixing Layer* on page 31 for more information.
3. Use the cursor button to select the ATT. control and the PARAMETER wheel to adjust it.

If you are using a mouse, position the mouse cursor over the ATT. control, press and hold the left mouse button, and then drag the mouse.

The Attenuation function can be used to compensate for level increases caused by EQ boosting or dynamics processing. Instead of using a GAIN control to reduce a boosted signal, it's better to use the Attenuation function. Although levels can be reduced using the GAIN controls, this also reduces the level of the signal being fed to the A/D converter, which is not desired. The Attenuation function comes after the A/D converter, so A/D conversion performance is not affected.

When channels are configured as a stereo pair using the Pair function (*Stereo Pairs* on page 114), the attenuators for each channel work together, and parameter adjustments can be made with either channel selected. You cannot set different parameters for the odd and even channels.

Phase

The Phase function reverses the phase of an input signal by 180 degrees. The phase can be set for input channels 1 to 24 and the left and right channels of stereo input channel. Phase reversal can be used to compensate for incorrectly wired balanced cables and microphones. When a snare drum is miked top and bottom, the channel connected to the bottom microphone can be phase reversed.

1. Use the [DELAY/Ø] button to locate the Phase page shown below.

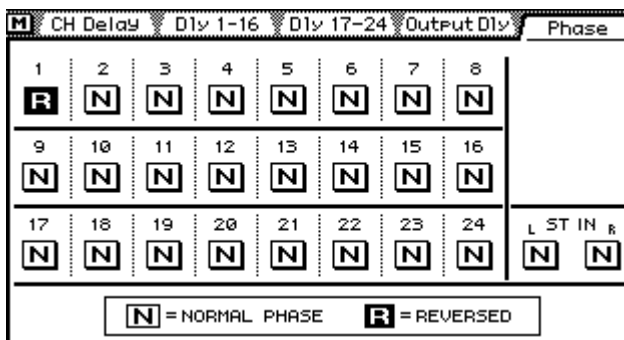

2. Use the [SEL] and [MIXING LAYER] buttons to select a channel. See Mixing Layer on page 31 for more information.
3. Use the [ENTER] button to set the phase of the selected channel.
You can also use the cursor button to select the phase switches. If you are using a mouse, simply click the phase switches. Phase switches can also be selected using the [SEL] buttons.

Normal phase

Phase reversed

The Phase function is not linked when channels are paired, and can be set independently for each channel in the stereo pair.

Channel Delay

The Delay function can be used to compensate for microphone placement, or simply as a delay effect. Three types of delay are available: Delay, Slap, and Echo. Delay can be applied to input channels 1 to 24 and the stereo input channel.

When channels are configured as a stereo pair using the Pair function (*Stereo Pairs* on page 114), the channel delays of the two channels work together, and parameter adjustments can be made with either channel selected. You cannot set different parameters for the odd and even channels.

1. Use the [DELAY/∅] button to locate the CH Delay page shown below.

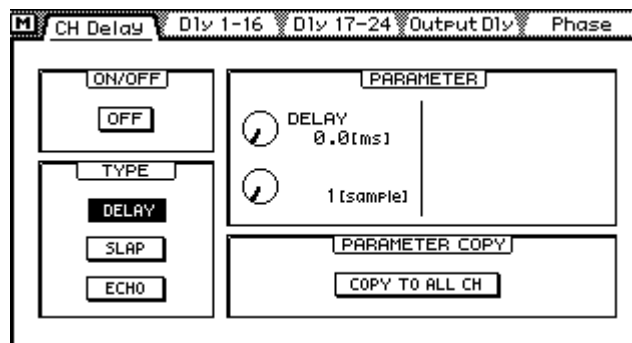

2. Use the [SEL] and [MIXING LAYER] buttons to select a channel. See *Mixing Layer* on page 31 for more information.
3. Use the cursor buttons to select the delay parameters and the [ENTER] button and PARAMETER wheel to set them.

If you are using a mouse, simply click the switches and drag the rotary controls.

ON/OFF—This switch is used to turn on and off the delay. When the cursor is located within the PARAMETER window, the [ENTER] button can be used to turn on and off the delay without having to select the ON/OFF switch.

TYPE—These switches are used to select the type of delay: DELAY, SLAP, or ECHO. The echo parameters are reset when the type of delay is changed.

PARAMETER—The controls in this window are delay parameter controls. The number of controls available depends on type of delay selected.

Parameter	Type	Range	Description
DELAY	DELAY SLAP ECHO	9,600 samples	Delay can be specified in either seconds or samples. The actual delay in seconds depends on the sampling rate. The maximum delay is 217.7 milliseconds at a sampling rate of 44.1 kHz, and 200.0 milliseconds at a sampling rate of 48 kHz.
MIX LEVEL	SLAP ECHO	-100 to +100	Determines the level of delayed signal. 0 is no delay. +50 is a 50:100 mix of delayed and dry signals. +100 is a 100:100 mix. Negative values are the same except the delayed signal is inverted.
FB. GAIN	ECHO	-99 to +99	Determines how much of the delayed signal is fed back into the delay. 0 is no feedback. +99 is maximum feedback. Negative values are the same except the feedback signal is inverted.

When the type of delay is changed from Delay to either Slap or Echo, the parameters are set as follows: Delay = 172 ms, Mix = 50%, Feedback = 18%. When the type is changed from Slap or Echo to Delay, the parameters are set as follows: Delay = 0 ms, Mix = 0%, Feedback = 0%.

PARAMETER COPY—The COPY TO ALL CH switch is used to copy the delay parameter settings to all input channels and the stereo input channel. The following dialog box appears when this switch is pressed.



Use OK to copy or CANCEL to cancel.

Viewing Channel Delay Settings

Channel delay settings can be viewed on the following two pages.

1. Use the [DELAY/∅] button to locate these pages.

The following page shows the delay settings for input channels 1 to 16.

M CH Delay								Dly 1-16	Dly 17-24	Output Dly	Phase
CHANNEL DELAY 1-16											
1	2	3	4	5	6	7	8				
DELAY	DELAY	DELAY	DELAY	DELAY	DELAY	DELAY	DELAY				
0.0	0.0	0.0	0.0	0.0	0.0	0.0	0.0				
[ms]	[ms]	[ms]	[ms]	[ms]	[ms]	[ms]	[ms]				
[sample]	[sample]	[sample]	[sample]	[sample]	[sample]	[sample]	[sample]				
OFF	OFF	OFF	OFF	OFF	OFF	OFF	OFF				
9	10	11	12	13	14	15	16				
DELAY	DELAY	DELAY	DELAY	DELAY	DELAY	DELAY	DELAY				
0.0	0.0	0.0	0.0	0.0	0.0	0.0	0.0				
[ms]	[ms]	[ms]	[ms]	[ms]	[ms]	[ms]	[ms]				
[sample]	[sample]	[sample]	[sample]	[sample]	[sample]	[sample]	[sample]				
OFF	OFF	OFF	OFF	OFF	OFF	OFF	OFF				

The following page shows the delay settings for input channels 17 to 24 and the stereo input channel.

M CH Delay								Dly 1-16	Dly 17-24	Output Dly	Phase
CHANNEL DELAY 17-24/ST IN											
17	18	19	20	21	22	23	24				
DELAY	DELAY	DELAY	DELAY	DELAY	DELAY	DELAY	DELAY				
0.0	0.0	0.0	0.0	0.0	0.0	0.0	0.0				
[ms]	[ms]	[ms]	[ms]	[ms]	[ms]	[ms]	[ms]				
[sample]	[sample]	[sample]	[sample]	[sample]	[sample]	[sample]	[sample]				
OFF	OFF	OFF	OFF	OFF	OFF	OFF	OFF				
ST IN											
DELAY											
0.0											
[ms]											
[sample]											
OFF											

These pages show the type of delay and delay time set for each channel. These settings cannot be changed on these pages. The delays can, however, be turned on and off.

2. Use the [SEL] buttons to select channels and the [ENTER] button to turn the delays on and off.

If you are using a mouse, simply click the switches. The switches can also be selected using the cursor buttons.

Applying EQ to the Input Channels EQ

Each input channel features four-band parametric EQ. See EQ on page 45 for more information.

Dynamics Processor

Each input channel features a dynamics processor. See Dynamics Processors on page 143 for more information.

Muting Input Channels (ON/OFF)



Channels can be muted using the [ON] buttons. These buttons contain an indicator that lights up when a channel is on. The function of each [ON] button depends on the selected Mixing Layer. See ON Buttons on page 31 for more information.

When the [SOLO] function is on, the [ON] buttons work as solo buttons, not mute buttons.

When channels are configured as a stereo pair using the Pair function (*Stereo Pairs* on page 114), the [ON] buttons of the two channels work together, and either button can be used to switch the pair on and off.

Channels can also be grouped for multiple mute control using only one [ON] button. See Mute Groups on page 113 for more information.

Setting Input Channel Levels

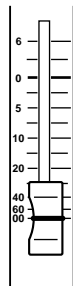

Input channel and stereo input channel levels are controlled using the faders. The function of each fader depends on the selected fader mode and Mixing Layer. See Faders on page 32 for more information. The selected fader mode is shown on the display. See Display on page 24 for more information. The stereo input channel fader is affected by the fader modes, but not the Mixing Layer.

1. Press the [FADER] button.

The Meter page appears and the faders function as normal channel faders.

2. Use the [MIXING LAYER] button to select Mixing Layer 1–16 or 17–24/MASTER.

3. Use the faders to adjust the channel levels.

When channels are configured as a stereo pair using the Pair function (*Stereo Pairs* on page 114), the faders of the two channels work together, and either fader can be used to adjust the level of the stereo pair.

Pan, Balance & Routing

Input channel and stereo input channel signals can be routed to buses 1 to 4 and the Stereo bus. Input channel signals can be panned. Stereo input channel signals can be balanced and panned. Stereo input channel pan can be used to adjust the width of stereo signals. Pan, balance, and routing settings are made on the Pan/Route pages. See Stereo Pan, Balance & Routing on page 59 for more information.

Direct Outputs

Up to eight post-fader signals from input channels 1 to 16 can be output directly via the YGDAI digital outputs. Direct out settings are made on the Pan/Route page. When a channel is set for direct out operation, the YGDAI OUTPUT ASSIGN for that channel is set automatically on the D.out Setup page. These settings can also be made manually. See Assigning Signals to the YGDAI Outputs on page 224 for more information.

1. Use the [PAN/ROUTING] button to locate the page shown below.

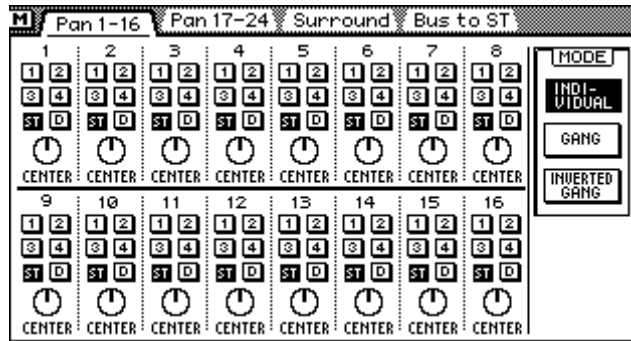

2. Use the [SEL] buttons to select an input channel from 1 to 16.
3. Use the cursor buttons to select the (D)irect out switches and the [ENTER] button to set them.

If you are using a mouse, simply click the (D)irect out switches.

Aux Sends

Input channel and stereo input channel signals can be sent to aux sends 1 to 4. Channel sends can be configured as either pre-fader or post-fader sends. See Aux Sends on page 89 for more information.

When aux sends are configured as a stereo pair, aux send pan controls are activated on the input channels, stereo input channel, and effects returns. See Aux Send Stereo Pairs on page 94 for more information.

Monitoring Input Channels

See Solo, Monitors & Meters on page 71 for more information.

Input Channel Stereo Pairs

Odd and even input channels from 1 to 24 can be paired for stereo operation. This makes it easy to work with stereo input signals, because you only need to adjust one input channel to control both the left and right channels of the stereo signal. Only adjacent odd and even input channels can be paired (i.e., 1/2, 3/4, 5/6, not 2/3 or 4/5). With 24 input channels, up to 12 stereo input pairs are possible. Input channel stereo pairs are configured on the Pair page. See Stereo Pairs on page 114 for more information.

When two input channels are paired, the following parameters are linked: channel delay, EQ, attenuators, dynamics processors, [ON] buttons, solo, channel faders, pre/post settings for the aux sends and effects sends, aux and effects send faders, and routing switches. Pan operation depends on the selected pan mode. See Pan Mode on page 60 for more information.

Input Channels Block Diagram

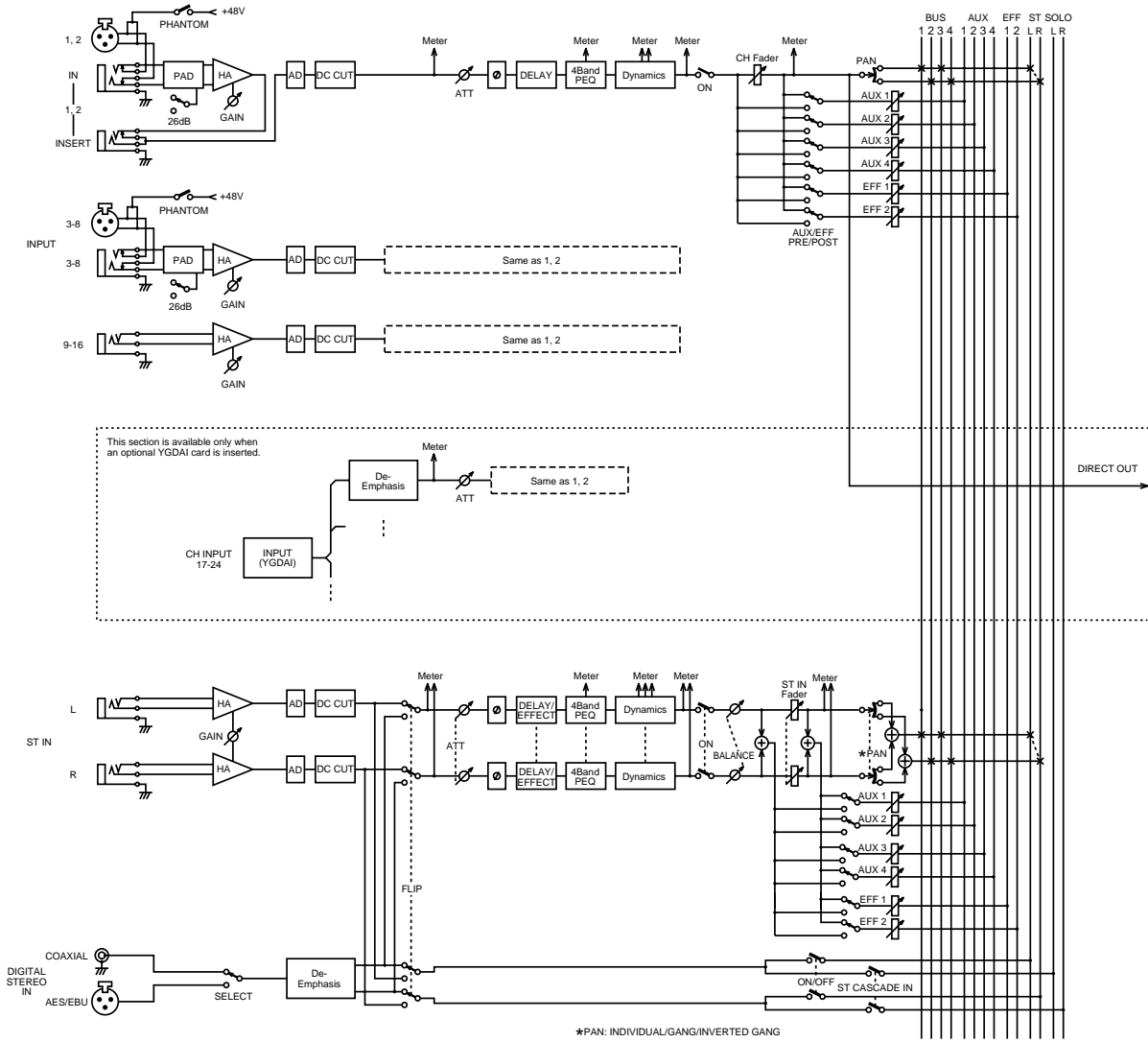

5

In this chapter...

About 03D EQ	46
Adjusting the EQ	47
Bypassing the EQ	47
Resetting the EQ Gain Controls	47
EQ Library	48
Storing EQ Programs	49
Recalling EQ Programs	50
Editing EQ Program Titles	51
Preset EQ Programs	52

About 03D EQ

03D EQ is four-band fully parametric, with variable gain, frequency, Q, and ON/OFF parameters. EQ is available on all input channels, the stereo input channel, the stereo output, bus outputs, aux sends, and the onboard effects returns. See the *Block Diagram* on page 21 for the exact location of each EQ section. Initially, each EQ section is configured as a conventional four-band EQ, with shelving high and low and peaking lo-mid and hi-mid. However, the low band can be configured for shelving, peaking, or HPF (High-Pass Filter) operation, while the hi band can be configured for shelving, peaking, or LPF (Low-Pass Filter) operation.

When channels are configured as a stereo pair using the Pair function (*Stereo Pairs* on page 114), the EQ sections, including attenuators, of the two channels work together, and parameter adjustments can be made with either channel selected. You cannot set different parameters for the odd and even channels.

EQ settings can be stored as programs in the EQ library. The EQ library contains 40 preset programs and 40 user programs. See *EQ Library* on page 48 for more information. EQ settings are also stored in scene memories (page 164) and the channel library (page 104).

EQ is controlled from the EQ page shown below.

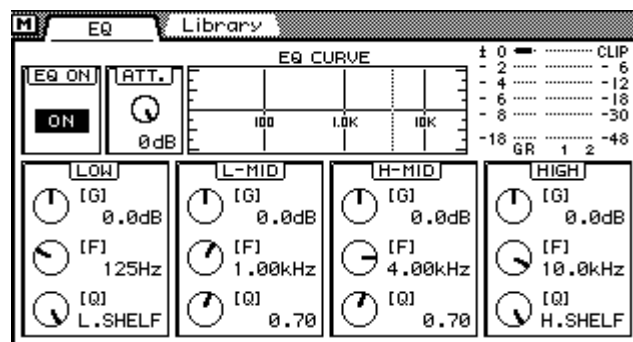

The top half of the EQ page shows the EQ curve for the selected channel. The bottom half contains the EQ controls.

Adjusting the EQ

1. Use the [SEL] and [MIXING LAYER] buttons to select a channel. See *Mixing Layer* on page 31 for more information.
2. Use the [EQ LOW], [LO-MID], [HI-MID], or [HIGH] button to access the EQ page shown below.

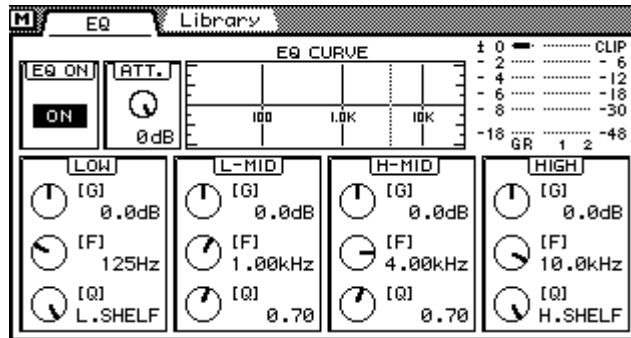

3. Use the [EQ LOW], [LO-MID], [HI-MID], and [HIGH] buttons to select the EQ parameters and the PARAMETER wheel to adjust them. Repeated pressing of the [EQ LOW], [LO-MID], [HI-MID], and [HIGH] button cycles through the gain, frequency, and Q parameters of the respective band, allowing quick and easy EQ adjustments.

You can also use the cursor buttons to select EQ parameters. If you are using a mouse, position the mouse cursor over a control, press and hold the left mouse button, and then drag the mouse.

The following table lists the EQ specs.

	Low	Lo-Mid	Hi-Mid	High
Gain	-18.0 dB to +18.0 dB (0.5 dB steps) ¹			
Frequency	21 Hz–20.1 kHz (1/12 octave steps, 120 steps) ²			
Q	HPF, 10.0–0.10 (41 steps), L.SHELF	10.0–0.10 (41 steps)		LPF, 10.0–0.10 (41 steps), H.SHELF

1. The Low and High gain controls work as filter on/off switches when the HPF and LPF filters are selected using the Q control.
2. This is the frequency range for sampling rates of 44.1 kHz and 48 kHz. At a sampling rate of 32 kHz the range is 21 Hz–15.1 kHz (115 steps).

Bypassing the EQ

To bypass the EQ for the selected channel, simply press the [ENTER] button. Press again to turn the EQ back on. On the EQ page the [ENTER] button can be used to bypass the EQ regardless of the cursor position. If you are using a mouse, simply click the EQ ON switch on the EQ page.



Resetting the EQ Gain Controls

To reset the EQ gain controls for the selected channel, press the EQ [HI-MID] and [HIGH] buttons together. The frequency and Q controls are not reset.

EQ Library

EQ settings can be stored as programs in the EQ library. The EQ library contains 40 preset programs (1–40) and 40 user programs (41–80). User programs allow you to store frequently used EQ settings, and they can be titled for easy identification. The EQ library can also be used to transfer settings from one EQ to another. For example, the stereo out EQ settings could be stored as a library program and then recalled to an aux send EQ. The unique collection of preset EQ programs are designed for specific applications and instruments, and provide a good reference and starting point when making EQ adjustments. See page 52 for a complete list of the preset EQ programs.

The EQ library is controlled from the Library page shown below. Press the [EQ LOW] and [LO-MID] buttons together to access the Library page. If you are using a mouse and the EQ page is already shown, simply click the Library page title tab.

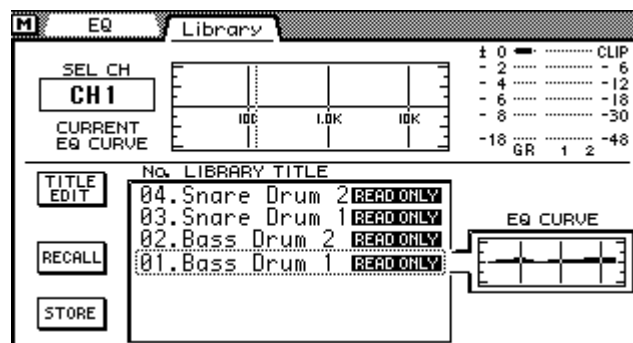

The top half of the Library page shows the EQ curve and signal levels for the selected channel. The bottom half contains the EQ library functions.

Storing EQ Programs

EQ programs are stored on the EQ Library page. You can store EQ settings to user programs 41 to 80. Preset programs 1 to 40 are read only.

1. Press the [EQ LOW] and [LO-MID] buttons together to access the Library page.

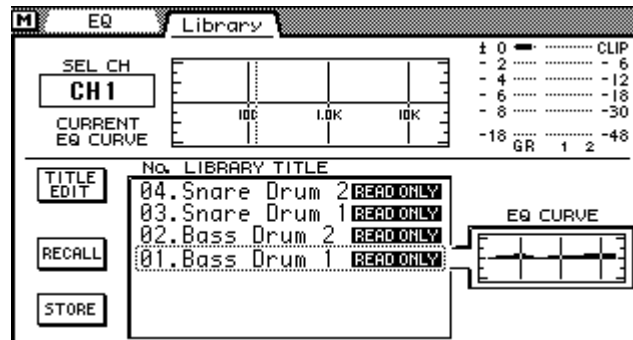

2. Use the [SEL] buttons to select the channel whose EQ settings you want to store as a program.
3. Use the PARAMETER wheel to scroll through the list of EQ programs. If you are using a mouse, position the mouse cursor over the parameter box, press and hold the left mouse button, and then drag the mouse. As each program is selected, its EQ curve appears in the EQ CURVE window. EQ programs that do not contain data have the title No Data!
4. Use the cursor button to select the STORE switch, and then press the [ENTER] button.
If you are using a mouse, simply click the STORE switch.
The Title Edit dialog box appears.
5. Enter a title for the EQ program.
See *Title Edit Dialog Box* on page 33 for more information.
6. Press OK on the Title Edit dialog box.
The EQ program is stored.

Recalling EQ Programs

EQ programs are recalled from the EQ Library page. You can recall any of the 40 preset and 40 user programs.

1. Press the [EQ LOW] and [LO-MID] buttons together to access the Library page.

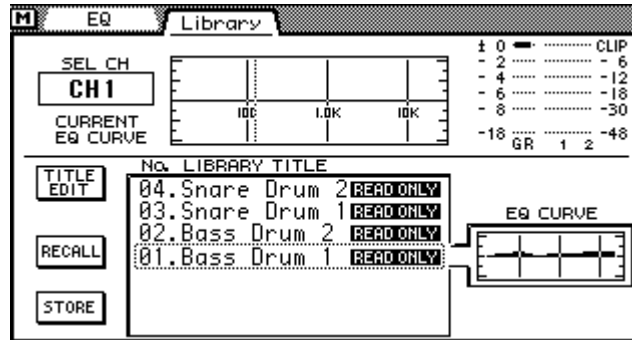

2. Use the [SEL] buttons to select the channel to which you want to recall the EQ program.
3. Use the PARAMETER wheel to scroll through the list of EQ programs. If you are using a mouse, position the mouse cursor over the parameter box, press and hold the left mouse button, and then drag the mouse. As each program is selected, its EQ curve appears in the EQ CURVE window. EQ programs that do not contain data have the title No Data!
4. Use the cursor button to select the RECALL switch, and then press the [ENTER] button.
If you are using a mouse, simply click the RECALL switch.
The EQ program is recalled.

Editing EQ Program Titles

EQ program titles can be edited at anytime. You don't have to recall a program to edit its title. Only EQ programs that contain data can have their titles edited. Title editing is performed on the EQ Library page shown below.

1. Press the [EQ LOW] and [LO-MID] buttons together to access the Library page.

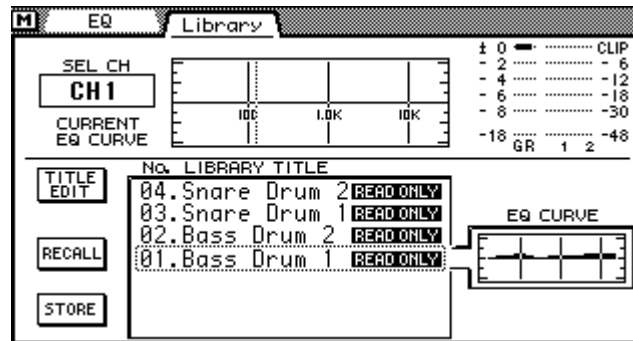

2. Select the EQ program using the PARAMETER wheel or mouse.
3. Use the cursor buttons to select the TITLE EDIT switch, and then press the [ENTER] button.
If you are using a mouse, simply click the TITLE EDIT switch.
The Title Edit dialog box appears.
4. Edit the program title.
See *Title Edit Dialog Box* on page 33 for more information.
5. When you've finished, select OK and press the [ENTER] button.
If you are using a mouse, simply click the OK switch.

Preset EQ Programs

#	Title	Parameter				Description	
			LOW	L-MID	H-MID		HIGH
01	Bass Drum 1		PEAKING	PEAKING	PEAKING	H.SHELF	Emphasizes the low range of a bass drum and the attack created by the beater.
		G	+3.5 dB	-3.5 dB	0.0 dB	+4.0 dB	
		F	99 Hz	265 Hz	1.05 kHz	5.33 kHz	
		Q	1.2	10	0.9	—	
02	Bass Drum 2		PEAKING	PEAKING	PEAKING	LPF	Creates a peak around 80Hz, producing a tight, stiff sound.
		G	+8.0 dB	-7.0 dB	+6.0 dB	ON	
		F	79 Hz	397 Hz	2.52 kHz	12.6 kHz	
		Q	1.4	4.5	2.2	—	
03	Snare Drum 1		PEAKING	PEAKING	PEAKING	H.SHELF	Emphasizes snapping and rimshot sounds.
		G	-0.5 dB	0.0 dB	+3.0 dB	+4.5 dB	
		F	132 Hz	1.00 kHz	3.17 kHz	5.04 kHz	
		Q	1.2	4.5	0.11	—	
04	Snare Drum 2		L.SHELF	PEAKING	PEAKING	PEAKING	Emphasizes the ranges of that classic rock snare drum sound.
		G	+1.5 dB	-8.5 dB	+2.5 dB	+4.0 dB	
		F	177 Hz	334 Hz	2.37 kHz	4.00 kHz	
		Q	—	10	0.7	0.1	
05	Tom-tom 1		PEAKING	PEAKING	PEAKING	PEAKING	Emphasizes the attack of tom-toms, and creates a long, "leathery" decay.
		G	+2.0 dB	-7.5 dB	+2.0 dB	+1.0 dB	
		F	210 Hz	667 Hz	4.49 kHz	6.35 kHz	
		Q	1.4	10	1.2	0.28	
06	Cymbal		L.SHELF	PEAKING	PEAKING	H.SHELF	Emphasizes the attack of crash cymbals, extending the "sparkling" decay.
		G	-2.0 dB	0.0 dB	0.0 dB	+3.0 dB	
		F	105 Hz	420 Hz	1.05 kHz	13.4 kHz	
		Q	—	8	0.9	—	
07	High Hat		L.SHELF	PEAKING	PEAKING	H.SHELF	Use on a tight high-hat, emphasizing the mid to high range.
		G	-4.0 dB	-2.5 dB	+1.0 dB	+0.5 dB	
		F	94 Hz	420 Hz	2.82 kHz	7.55 kHz	
		Q	—	0.5	1	—	
08	Percussion		L.SHELF	PEAKING	PEAKING	H.SHELF	Emphasizes the attack and clarifies the high-range of instruments, such as shakers, cabasas, and congas.
		G	-4.5 dB	0.0 dB	+2.0 dB	0.0 dB	
		F	99 Hz	397 Hz	2.82 kHz	16.9 kHz	
		Q	—	4.5	0.56	—	
09	E.Bass 1		L.SHELF	PEAKING	PEAKING	H.SHELF	Makes a tight electric bass sound by cutting very low frequencies.
		G	-7.5 dB	+4.5 dB	+2.5 dB	0.0 dB	
		F	35 Hz	111 Hz	2.00 kHz	4.00 kHz	
		Q	—	5	4.5	—	
10	E.Bass 2		PEAKING	PEAKING	PEAKING	H.SHELF	Unlike program 9, this program emphasizes the low range of an electric bass.
		G	+3.0 dB	0.0 dB	+2.5 dB	+0.5 dB	
		F	111 Hz	111 Hz	2.24 kHz	4.00 kHz	
		Q	0.1	5	6.3	—	

#	Title	Parameter				Description	
			LOW	L-MID	H-MID		HIGH
11	Syn.Bass 1		PEAKING	PEAKING	PEAKING	H.SHELF	Use on a synth bass with emphasized low range.
		G	+3.5 dB	+8.5 dB	0.0 dB	0.0 dB	
		F	83 Hz	944 Hz	4.00 kHz	12.6 kHz	
		Q	0.1	8	4.5	—	
12	Syn.Bass 2		PEAKING	PEAKING	PEAKING	H.SHELF	Emphasizes the attack that is peculiar to a synth bass.
		G	+2.5 dB	0.0 dB	+1.5 dB	0.0 dB	
		F	125 Hz	177 Hz	1.12 kHz	12.6 kHz	
		Q	1.6	8	2.2	—	
13	Piano 1		L.SHELF	PEAKING	PEAKING	H.SHELF	This is used to make a piano sound brighter.
		G	-6.0 dB	0.0 dB	+2.0 dB	+4.0 dB	
		F	94 Hz	944 Hz	3.17 kHz	7.55 kHz	
		Q	—	8	0.9	—	
14	Piano 2		PEAKING	PEAKING	PEAKING	H.SHELF	Used in conjunction with a compressor, this program emphasizes the attack and low range of a piano sound.
		G	+3.5 dB	-8.5 dB	+1.5 dB	+3.0 dB	
		F	223 Hz	595 Hz	3.17 kHz	5.33 kHz	
		Q	5.6	10	0.7	—	
15	E.G.Clean		PEAKING	PEAKING	PEAKING	H.SHELF	Use for line-recording an electric guitar or semi-acoustic guitar to get a slightly hard sound.
		G	+2.0 dB	-5.5 dB	+0.5 dB	+2.5 dB	
		F	265 Hz	397 Hz	1.33 kHz	4.49 kHz	
		Q	0.18	10	6.3	—	
16	E.G.Crunch 1		PEAKING	PEAKING	PEAKING	PEAKING	Adjusts the tonal quality of a slightly distorted guitar sound.
		G	+4.5 dB	0.0 dB	+4.0 dB	+2.0 dB	
		F	140 Hz	1.00 kHz	1.88 kHz	5.65 kHz	
		Q	8	4.5	0.63	9	
17	E.G.Crunch 2		PEAKING	PEAKING	PEAKING	H.SHELF	A variation on program 16.
		G	+2.5 dB	+1.5 dB	+2.5 dB	0.0 dB	
		F	125 Hz	445 Hz	3.36 kHz	19.0 kHz	
		Q	8	0.4	0.16	—	
18	E.G.Dist. 1		L.SHELF	PEAKING	PEAKING	H.SHELF	Makes a heavily distorted guitar sound clearer.
		G	+5.0 dB	0.0 dB	+3.5 dB	0.0 dB	
		F	354 Hz	944 Hz	3.36 kHz	12.6 kHz	
		Q	—	9	10	—	
19	E.G.Dist. 2		L.SHELF	PEAKING	PEAKING	H.SHELF	A variation on program 18.
		G	+6.0 dB	-8.5 dB	+4.5 dB	+4.0 dB	
		F	315 Hz	1.05 kHz	4.23 kHz	12.6 kHz	
		Q	—	10	4	—	
20	A.G.Stroke 1		PEAKING	PEAKING	PEAKING	H.SHELF	Emphasizes the bright tones of an acoustic guitar.
		G	-2.0 dB	0.0 dB	+1.0 dB	+4.0 dB	
		F	105 Hz	1.00 kHz	1.88 kHz	5.33 kHz	
		Q	0.9	4.5	3.5	—	

#	Title	Parameter				Description	
			LOW	L-MID	H-MID		HIGH
21	A.G.Stroke 2		L.SHELF	PEAKING	PEAKING	H.SHELF	A variation on program 20. You can also use it with a gutsy guitar sound.
		G	-3.5 dB	-2.0 dB	0.0 dB	+2.0 dB	
		F	297 Hz	749 Hz	2.00 kHz	3.56 kHz	
		Q	—	9	4.5	—	
22	A.G.Arpeg. 1		L.SHELF	PEAKING	PEAKING	PEAKING	Corrects arpeggio technique of an acoustic guitar.
		G	-0.5 dB	0.0 dB	0.0 dB	+2.0 dB	
		F	223 Hz	1.00 kHz	4.00 kHz	6.72 kHz	
		Q	—	4.5	4.5	0.12	
23	A.G.Arpeg. 2		L.SHELF	PEAKING	PEAKING	H.SHELF	A variation on program 22.
		G	0.0 dB	-5.5 dB	0.0 dB	+4.0 dB	
		F	177 Hz	354 Hz	4.00 kHz	4.23 kHz	
		Q	—	7	4.5	—	
24	Brass Sec.		PEAKING	PEAKING	PEAKING	PEAKING	Use with trumpets, trombones, or sax. With one instrument, adjust the HIGH or H-MID frequency.
		G	-2.0 dB	-1.0 dB	+1.5 dB	+3.0 dB	
		F	88 Hz	841 Hz	2.11 kHz	4.49 kHz	
		Q	2.8	2	0.7	7	
25	Male Vocal 1		PEAKING	PEAKING	PEAKING	PEAKING	Use as a template for male vocal. Adjust the HIGH or H-MID setting according to the voice quality.
		G	-0.5 dB	0.0 dB	+2.0 dB	+3.5 dB	
		F	187 Hz	1.00 kHz	2.00 kHz	6.72 kHz	
		Q	0.11	4.5	0.56	0.11	
26	Male Vocal 2		PEAKING	PEAKING	PEAKING	H.SHELF	A variation on program 25.
		G	+2.0 dB	-5.0 dB	-2.5 dB	+4.0 dB	
		F	167 Hz	236 Hz	2.67 kHz	6.72 kHz	
		Q	0.11	10	5.6	—	
27	Female Vo. 1		PEAKING	PEAKING	PEAKING	PEAKING	Use as a template for female vocal. Adjust the HIGH or H-MID setting according to the voice quality.
		G	-1.0 dB	+1.0 dB	+1.5 dB	+2.0 dB	
		F	118 Hz	397 Hz	2.67 kHz	5.99 kHz	
		Q	0.18	0.45	0.56	0.14	
28	Female Vo. 2		L.SHELF	PEAKING	PEAKING	H.SHELF	A variation on program 27.
		G	-7.0 dB	+1.5 dB	+1.5 dB	+2.5 dB	
		F	111 Hz	334 Hz	2.00 kHz	6.72 kHz	
		Q	—	0.16	0.2	—	
29	Chorus&Harmo		PEAKING	PEAKING	PEAKING	PEAKING	Use as a template for a chorus. It makes the entire chorus much brighter.
		G	-2.0 dB	-1.0 dB	+1.5 dB	+3.0 dB	
		F	88 Hz	841 Hz	2.11 kHz	4.49 kHz	
		Q	2.8	2	0.7	7	
30	Total EQ 1		PEAKING	PEAKING	PEAKING	H.SHELF	Use on a stereo mix during mixdown. Sounds even better when used with a compressor.
		G	-0.5 dB	0.0 dB	+3.0 dB	+6.5 dB	
		F	94 Hz	944 Hz	2.11 kHz	16.0 kHz	
		Q	7	2.2	5.6	—	

#	Title	Parameter				Description	
			LOW	L-MID	H-MID		HIGH
31	Total EQ 2		PEAKING	PEAKING	PEAKING	H.SHELF	A variation on program 30.
		G	+4.0 dB	+1.5 dB	+2.0 dB	+6.0 dB	
		F	94 Hz	749 Hz	1.78 kHz	17.9 kHz	
		Q	7	2.8	5.6	—	
32	Total EQ 3		L.SHELF	PEAKING	PEAKING	H.SHELF	A variation on program 30. Can also be used with stereo inputs or external effect returns.
		G	+1.5 dB	+0.5 dB	+2.0 dB	+4.0 dB	
		F	66 Hz	841 Hz	1.88 kHz	15.1 kHz	
		Q	—	0.28	0.7	—	
33	Bass Drum 3		PEAKING	PEAKING	PEAKING	PEAKING	A variation on program 1. The low and mid range is removed.
		G	+3.5 dB	-10.0 dB	+3.5 dB	0.0 dB	
		F	118 Hz	315 Hz	4.23 kHz	20.1 kHz	
		Q	2	10	0.4	0.4	
34	Snare Drum 3		L.SHELF	PEAKING	PEAKING	PEAKING	A variation on program 3. It creates a thick sound.
		G	0.0 dB	+2.0 dB	+3.5 dB	0.0 dB	
		F	223 Hz	561 Hz	4.23 kHz	4.00 kHz	
		Q	—	4.5	2.8	0.1	
35	Tom-tom 2		L.SHELF	PEAKING	PEAKING	H.SHELF	A variation on program 5. Emphasizes the mid and high range.
		G	-9.0 dB	+1.5 dB	+2.0 dB	0.0 dB	
		F	88 Hz	210 Hz	5.33 kHz	16.9 kHz	
		Q	—	4.5	1.2	—	
36	Piano 3		PEAKING	PEAKING	PEAKING	H.SHELF	A variation on program 13.
		G	+4.5 dB	-13.0 dB	+4.5 dB	+2.5 dB	
		F	99 Hz	472 Hz	2.37 kHz	10.0 kHz	
		Q	8	10	9	—	
37	Piano Low		PEAKING	PEAKING	PEAKING	H.SHELF	Use for the low range of a piano sound recorded in stereo.
		G	-5.5 dB	+1.5 dB	+6.0 dB	0.0 dB	
		F	187 Hz	397 Hz	6.72 kHz	12.6 kHz	
		Q	10	6.3	2.2	—	
38	Piano High		PEAKING	PEAKING	PEAKING	PEAKING	Use for the high range of a piano sound recorded in stereo.
		G	-5.5 dB	+1.5 dB	+5.0 dB	+3.0 dB	
		F	187 Hz	397 Hz	6.72 kHz	5.65 kHz	
		Q	10	6.3	2.2	0.1	
39	Fine-EQ Cass		L.SHELF	PEAKING	PEAKING	H.SHELF	Use when recording to or from cassette tape to make the sound clearer.
		G	-1.5 dB	0.0 dB	+1.0 dB	+3.0 dB	
		F	74 Hz	1.00 kHz	4.00 kHz	12.6 kHz	
		Q	—	4.5	1.8	—	
40	Narrator		PEAKING	PEAKING	PEAKING	H.SHELF	Use when recording narration.
		G	-4.0 dB	-1.0 dB	+2.0 dB	0.0 dB	
		F	105 Hz	707 Hz	2.52 kHz	10.0 kHz	
		Q	4	7	0.63	—	

Pan, Routing & Surround Pan

6

In this chapter...

Selecting a Pan Mode	58
Stereo Pan, Balance & Routing	59
Stereo Pairs, Pan & Routing	61
Surround Pan	62
Using Surround Pan	65

Selecting a Pan Mode

In addition to stereo pan, the 03D features three surround pan modes. Pan modes are set on the Surround page.

1. Use the [PAN/ROUTING] button to locate the Surround page shown below.

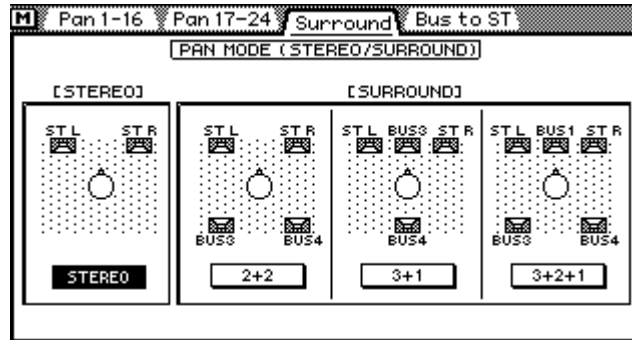

2. Use the cursor buttons to select a pan mode.
3. Press the [ENTER] button to activate the selected pan mode.

If you are using a mouse, simply click a Pan mode switch.

When a surround pan mode is selected, the Bus to ST page title tab is replaced by the Surr. 1–16 and Surr. 17–24 surround pan page title tabs, as shown below. The Bus to ST page is available only when stereo pan mode is selected.

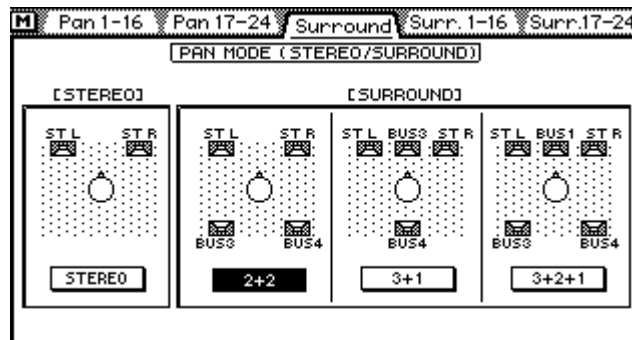

Stereo pan mode is explained in *Stereo Pan, Balance & Routing* on page 59.

The surround pan modes are explained in *Surround Pan* on page 62.

Stereo Pan, Balance & Routing

Input channel, stereo input channel, and effects return signals can be routed to buses 1 to 4 and the Stereo bus. Input channel signals can be panned. Stereo input channel and effects return signals can be balanced and panned. This pan can be used to adjust the width of stereo signals. Pan, balance, and routing settings are made on the Pan/Route pages.

1. Use the [PAN/ROUTING] button to locate the pages shown below.
The following page contains the pan and routing parameters for input channels 1 to 16.

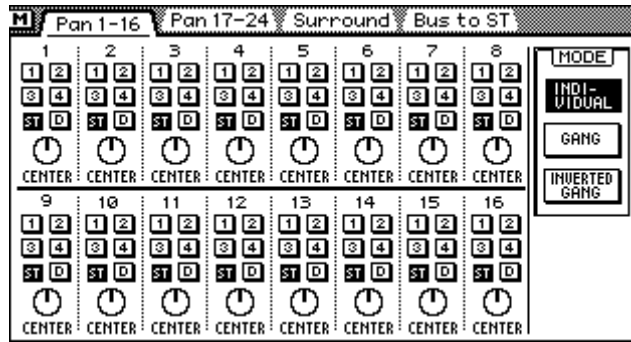

The following page contains the pan and routing parameters for input channels 17 to 24, the stereo input channel, and effects returns.

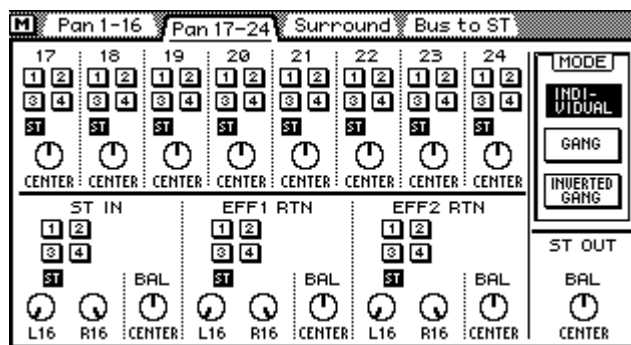

2. Use the [SEL] and [MIXING LAYER] buttons to select a channel. See Mixing Layer on page 31 for more information.
3. Use the cursor buttons to select parameters and the [ENTER] button and PARAMETER wheel to set them.

If you are using a mouse, simply click the bus routing switches. For pan and balance, position the mouse cursor over a pan control, press and hold the left mouse button, and then drag the mouse.

Pan & Balance



Input channels 1 to 24 use a single pan control to pan signals between the left and right stereo buses, and odd and even buses.





The stereo input channel and effects returns have two pan controls: one for the left signal and one for the right. These pan controls can be used to adjust the width of stereo signals.



With the left control set at L16 and the right control set at R16, as shown, the width of a stereo signal is 100%.

 With both controls set at CENTER, as shown, the width of a stereo signal is reduced to zero, and it's fed to the buses in mono.

 Setting the controls to positions in between these two extremes allows you set the width of the stereo signal. To maintain a central balance, however, you must set both controls to corresponding values. For example, L5 and R5, or L10 and R10.

 The stereo input channel and effects returns have balance controls. The balance control can be used to balance the levels of the left and right signals. They does not affect the width of a stereo signal.

Including center, there are 33 pan and balance positions.

Left Center Right
 L16←L15←...←L2←L1← CENTER →R1→R2→...→R15→R16

Pan Mode

The MODE switches, which are common to the Pan 1–16, Pan 17–24, and Bus to ST pages, are used to set the pan mode for the stereo input channel, stereo effects returns, and input channels that are configured as stereo pairs.

 In this mode, pan controls can be adjusted individually.



 In this mode, pan controls are ganged together.





 In this mode, pan controls are ganged together but operation is inverted (i.e., pan controls move in opposite directions).



Routing

A highlighted routing switch indicates that a channel is routed to a bus.

 Input channels 1 to 16 have four bus routing switches (1, 2, 3, 4), a stereo routing switch (ST), and a direct out switch (D). See page 43 for information about the direct output switch.

 Input channels 17 to 24, the stereo input channel, and the effects returns have four bus routing switches (1, 2, 3, 4) and one stereo routing switch (ST).

 Routing switches are joined into one when bus outs are configured as stereo pairs, as shown here. See Configuring Stereo Pairs on page 114 for more information.

Stereo Pairs, Pan & Routing

When input channels are configured as a stereo pair using the Pair function (*Stereo Pairs* on page 114), control operation changes.

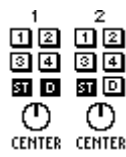

Here input channels 1 and 2 have been configured as a stereo pair. Clicking a routing switch on either channel sets the routing for both channels.

The operation of the two pan controls depends on the selected pan mode. See Pan Mode on page 60 for more information.

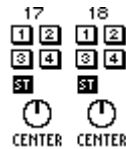

Here input channels 17 and 18 have been configured as a stereo pair.

Operation is the same as for input channels 1 and 2 shown above except there is no direct output switch.

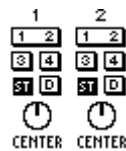

Routing switches are joined into one when bus outs are configured as stereo pairs, as shown here. See Configuring Stereo Pairs on page 114 for more information.

Surround Pan

As well as normal stereo pan, the 03D features three surround pan modes: 2+2, 3+1, and 3+2+1. In conjunction with the stereo out and bus outs, surround pan controls allow you to pan channel signals in a two-dimensional space. Surround pan controls can be used to move sounds in a circular motion, ellipse, semicircle, or straight line. Sounds can also be moved around the two-dimensional space using a mouse.

Surround pan modes are selected on the Surround page. See *Selecting a Pan Mode* on page 58 for more information.

Output Assignments

The following table shows how the surround channels are assigned to the 03D outputs for each surround pan mode. Connect the outputs that correspond to the surround mode you are using to a surround sound monitoring system or recorder.

Mode	ST-L	ST-R	BUS 1	BUS 2	BUS 3	BUS 4
Stereo	L (left)	R (right)	—	—	—	—
2+2	FL (front left)	FR (front right)	—	—	RL (rear left)	RR (rear right)
3+1	L (left)	R (right)	—	—	C (center)	S (surround)
3+2+1	FL (front left)	FR (front right)	FC (front center)	SW (subwoofer)	RL (rear left)	RR (rear right)

Stereo Mode

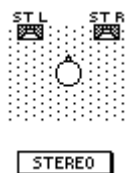

This is the normal stereo pan mode, with left and right front channels. It's not really a surround pan mode, but it's mentioned here for completeness and to highlight the differences between the various pan modes. See *Stereo Pan, Balance & Routing* on page 59 for more information. The following illustration shows a normal stereo sound system using the 03D.

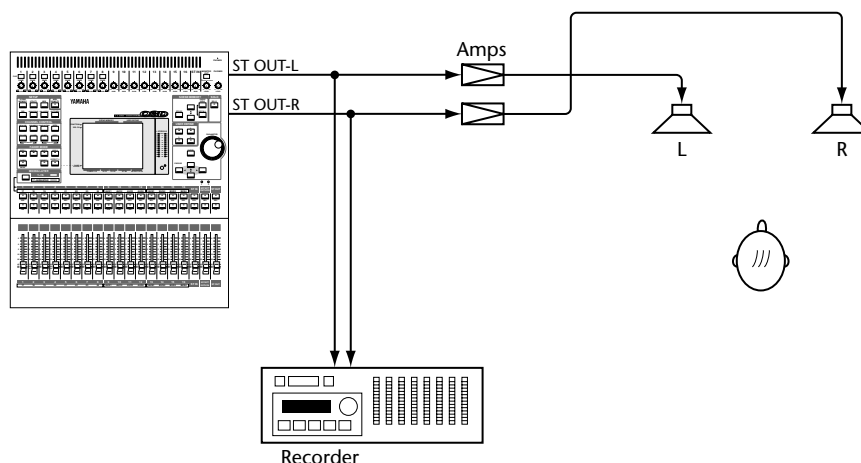

2+2 Surround Mode

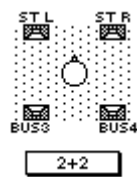

The 2+2 surround pan mode uses four channels: front left, front right, rear left, and rear right. The front speakers are fed from the 03D stereo output, while the rear speakers are fed from bus outs 3 and 4.

The following illustration shows a 2+2 surround sound system using the 03D.

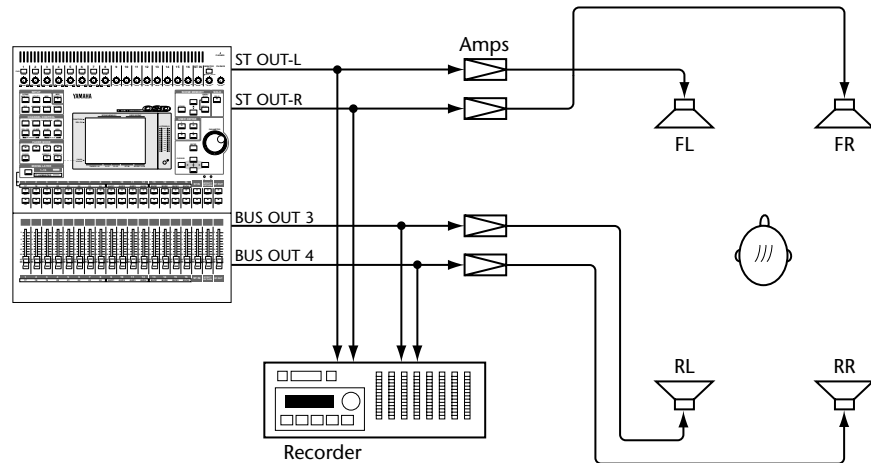

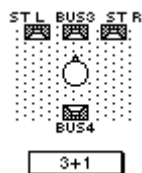

- 1** **2** In 2+2 mode, channel routing and pan looks like this. The pan control and 1 and 2 routing switches can still be used to assign the channel signal to bus outs 1 and 2. The SURR switch is used to route the channel to the surround sound outputs.
- SURR**
- D**
- CENTER**

3+1 Surround Mode

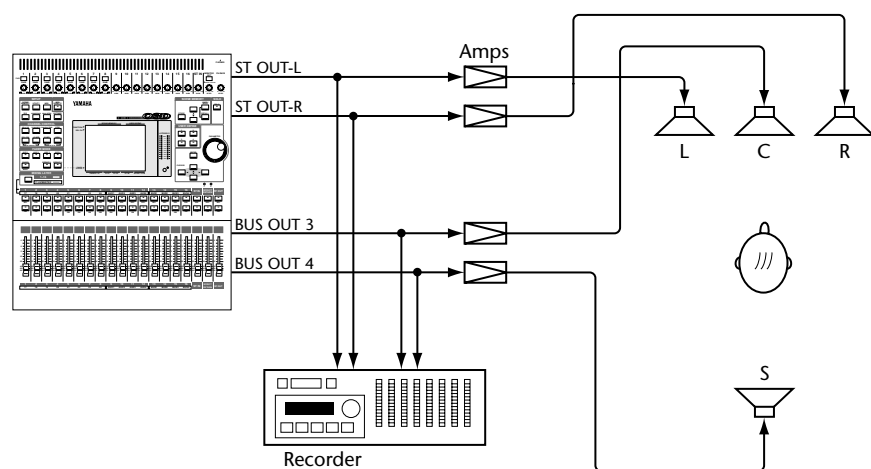

The 3+1 surround pan mode uses four channels: front left, front right, center, and surround. The front speakers are fed from the 03D stereo output, the center speaker is fed from bus out 3, and the surround speaker is fed from bus out 4. The following illustration shows a 3+1 surround sound system using the 03D. This could be used for Dolby Surround authoring.



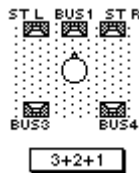

 In 3+1 mode, channel routing and pan look like this. The pan control and 1 and 2 routing switches can still be used to assign the channel signal to bus outs 1 and 2. The SURR switch is used to assign the channel to the surround sound outputs.

3+2+1 Surround Mode

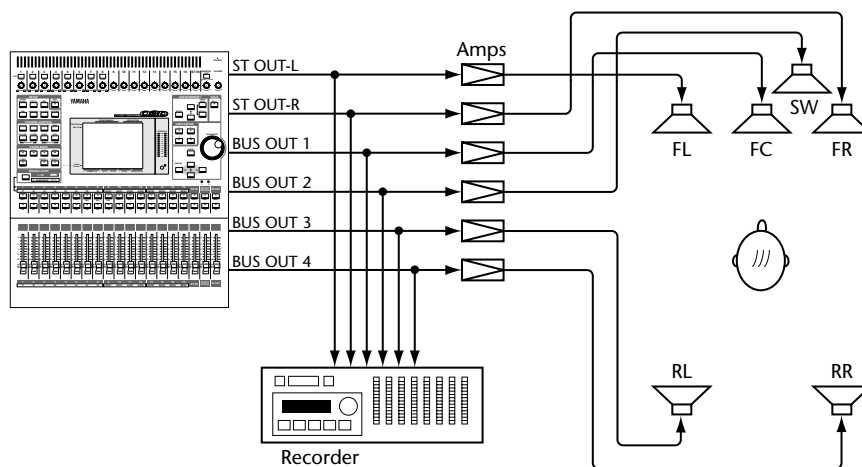

The 3+2+1 surround pan mode uses six channels: front left, front right, rear left, rear right, front center, and subwoofer. The front speakers are fed from the 03D stereo output, the rear speakers are fed from bus outs 3 and 4, the front center speaker is fed from bus out 1, and the subwoofer is fed from bus out 2. The following illustration shows a 3+2+1 surround sound system using the 03D. This could be used for Dolby AC-3 Surround authoring.



 In 3+2+1 mode, channel routing looks like this. The pan control is replaced with a sub woofer trim control, and routing switches 1 and 2 are replaced by a subwoofer assign switch. The SURR switch is used to assign the channel to the surround sound outputs.

Using Surround Pan

When a surround pan mode is selected (see *Selecting a Pan Mode* on page 58), the Surr. 1–16 and Surr. 17–24 surround pan pages shown below can be accessed.



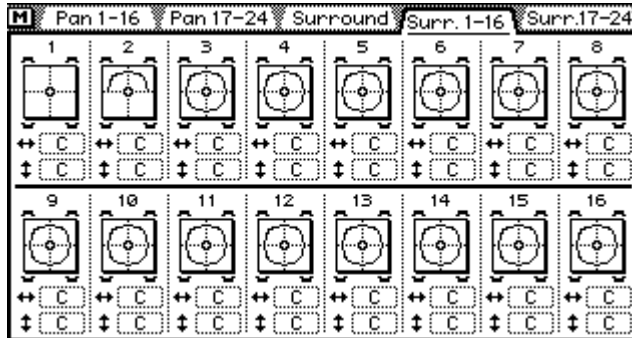

1. Use the [PAN/ROUTING] button to locate the Surr. 1–16 and Surr. 17–24 pages shown below.

The Surr. 1–16 page contains surround pan controls for input channels 1 to 16.

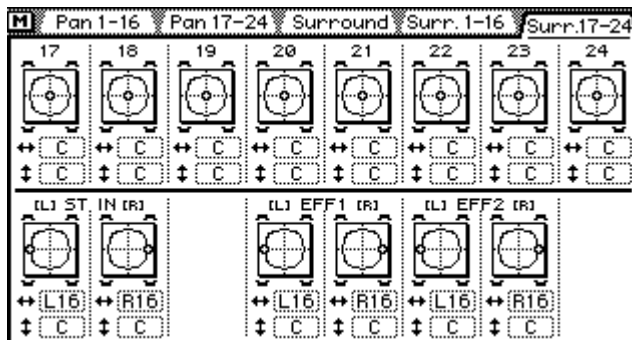

The Surr. 17–24 page contains surround pan controls for input channels 17 to 24, the stereo input channel, and the effects returns. The left and right channels of the stereo input channel and effects returns can be panned independently.



 The surround pan position for each channel is displayed on a two-dimensional pan graph. The pan position is indicated by a small circle. Small speaker icons  above and below the pan graph indicate the selected surround pan mode. In  this example, two speakers at the front and two at the rear indicate that 2+2 surround mode is selected. The larger circle indicates that the circle trajectory is selected. Trajectory settings are made on the surround pan trajectory window. Below the pan graph are two parameters. The  (left/right) parameter indicates the left to right position. The  (front/rear) parameter indicates the front to rear position. These parameters can also be used to adjust the positions.

2. Use the [SEL] buttons to select a channel, and then press the [ENTER] button.

If you are using a mouse, simply click a pan graph.

The surround pan trajectory window shown below appears.

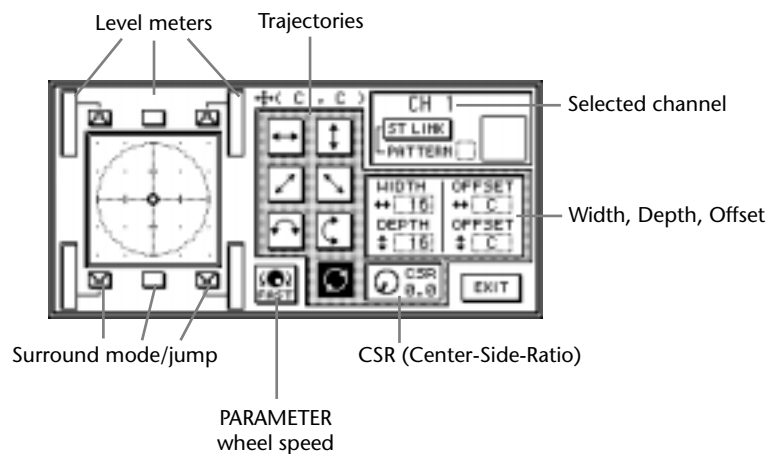



3. **Use the cursor buttons to select a trajectory, and then press the [ENTER] button to activate it.**
See Surround Pan Trajectories on page 67 for more information.
If you are using a mouse, simply click the trajectory switches.
4. **Use the cursor buttons to select the width, depth, and offset parameters and the PARAMETER wheel to set them.**
If you are using a mouse, position the mouse cursor over the width, depth, and offset parameters, press and hold the left mouse button, and then drag the mouse.
The width, depth, and offset parameters are not available for the left-to-right and front-to-rear trajectories.
5. **Move the cursor onto a trajectory switch, and then use the PARAMETER wheel to pan the sound along the selected trajectory.**
When the cursor is on a width, depth, or offset parameter, the PARAMETER wheel adjusts that parameter. When the cursor is on a trajectory switch, however, the PARAMETER wheel can be used to pan the sound along the selected trajectory.
If you are using a mouse, you can move sounds around the two-dimensional pan graph in real time.
6. **Use the cursor buttons to select the surround mode/jump switches, and then press the [ENTER] button to move sounds.**
The surround mode/jump switches correspond to the speaker layout of the selected surround pan mode.
7. **To close the surround pan trajectory window, use the cursor buttons to select the EXIT switch, and then press the [ENTER] button.**
If you are using a mouse, simply click the EXIT switch.
When the Surr. 1–16 or Surr. 17–24 surround pan page appears, you can still use the PARAMETER wheel to pan the sound along the selected trajectory.

Surround Pan Trajectories

The following surround pan trajectories are available.

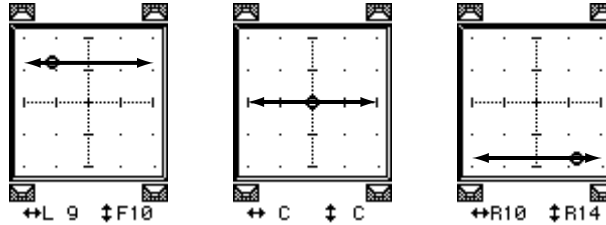
-  **Left to right**—The sound moves from left to right. The following illustrations show some typical left to right trajectories.



-  **Front to rear**—The sound moves from front to back. The following illustrations show some typical front to rear trajectories.

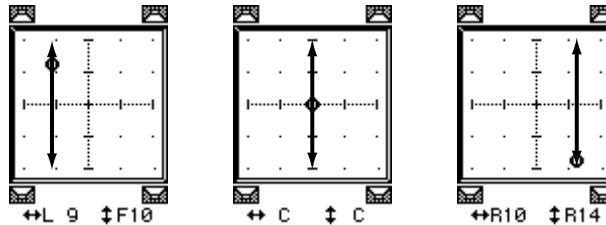

-  **Rear left to front right diagonal**—The sound moves on a diagonal trajectory from the rear left to the front right. Width, depth and offset can be set for this trajectory. The following illustrations show some typical trajectories.

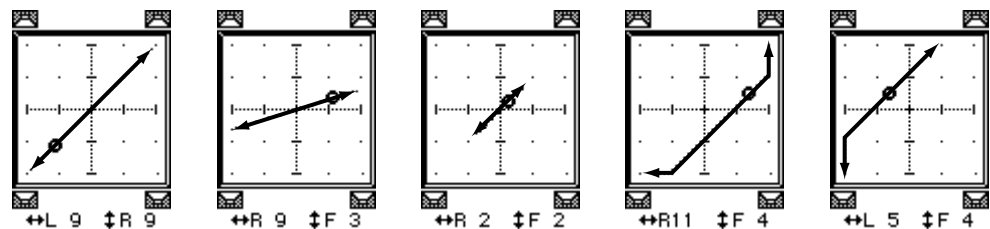

-  **Front left to rear right diagonal**—The sound moves on a diagonal trajectory from the front left to the rear right. Width, depth and offset can be set for this trajectory. The following illustrations show some typical trajectories.

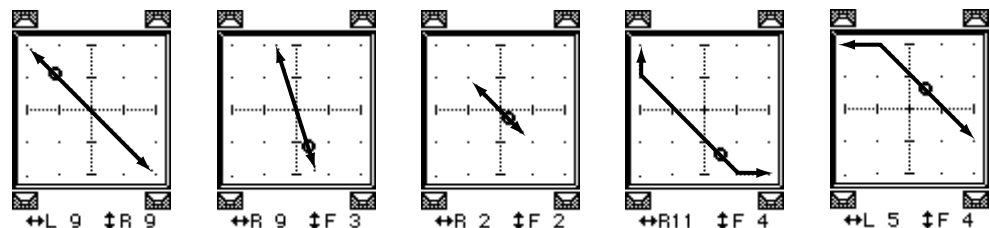

 **Left to right semicircle**—The sound moves from left to right on a semicircle trajectory. Use the width and depth parameters to set the size and shape of the semicircle. The shape can be adjusted from a semicircle to a narrow oval. Use the offset parameters to offset the trajectory to the left, right, front, or rear. The following illustrations show some typical trajectories.

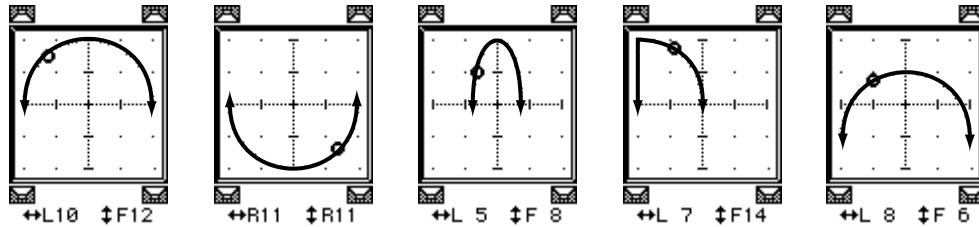

 **Front to rear semicircle**—The sound moves from front to rear on a semicircle trajectory. Use the width and depth parameters to set the size and shape of the semicircle. The shape can be adjusted from a semicircle to a narrow oval. Use the offset parameters to offset the trajectory to the left, right, front, or rear. The following illustrations show some typical trajectories.

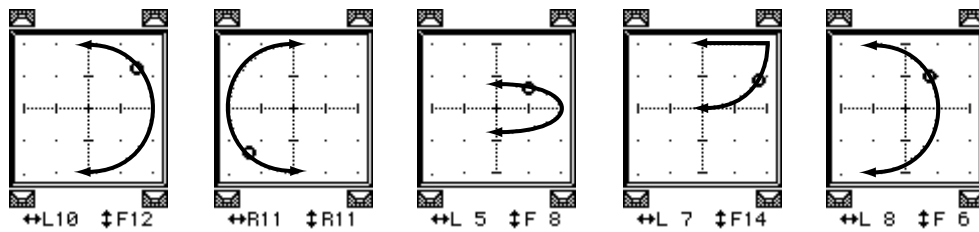

 **Circle**—The sound moves on a circular trajectory. Use the width and depth parameters to set the size and shape. The shape can be adjusted from a perfect circle to a narrow oval. Use the offset parameters to offset the trajectory to the left, right, front, or rear. The following illustrations show some typical trajectories.

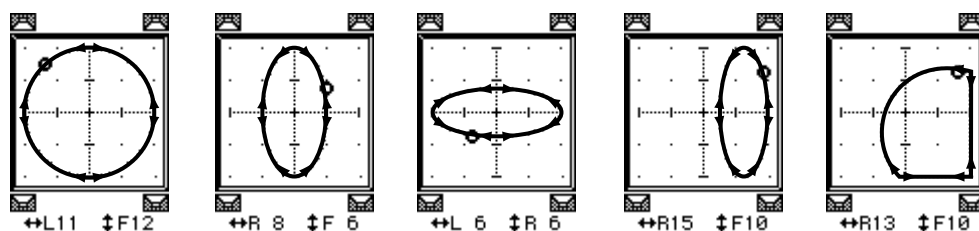

Stereo Link

For input channels configured as a stereo pair you can select a pattern and trajectory and move both signals simultaneously.

1. **Configure two input channels as a stereo pair.**
See Stereo Pairs on page 114 for more information.
2. **Use the cursor buttons to select the ST LINK switch, and then press the [ENTER] button to turn on the Stereo Link function.**



3. **Use the cursor buttons to select the PATTERN parameter and the PARAMETER wheel to select a pattern.**

The following illustration shows how the two channels are panned in each pattern for each of the available trajectories.

Trajectory \ Pattern	←→	↑↓	↗↘	↖↙	↻	↻	↻
←→	←→	↑↓	↗↘	↖↙	↻	↻	↻
↻	←→	↑↓	↗↘	↖↙	↻	↻	↻
↻	←→	↑↓	↗↘	↖↙	↻	↻	↻
↻	←→	↑↓	↗↘	↖↙	↻	↻	↻
↻	←→	↑↓	↗↘	↖↙	↻	↻	↻
↻	←→	↑↓	↗↘	↖↙	↻	↻	↻
↻	←→	↑↓	↗↘	↖↙	↻	↻	↻
↻	←→	↑↓	↗↘	↖↙	↻	↻	↻

CSR (Center:Side Ratio)

For the 3+1 and 3+2+1 surround modes that use a center speaker, the CSR (Center:Side Ratio) control can be used to set the amount of front-center sound heard through the center and left and right front speakers.

CSR	Description
0	The front-center sound appears only in the left and right speakers.
0.5	The front-center sound appears in the center and left and right speakers at the same level.
1.0	The front-center sound appears only in the center speaker.

Solo, Monitors & Meters



In this chapter...

About Monitor & Solo	72
Monitor Outputs	73
Phones	73
Monitoring	74
Setting Up Solo	75
Using Solo	76
Solo Safe	77
Two-track Input	77
Solo Block Diagram	78
Metering	79
Monitor Block Diagram	82

About Monitor & Solo

The 03D's flexible monitoring and solo functions are designed for use in a wide range of applications. Pre-fader or post-fader signals from all inputs and outputs can be monitored via the monitor out and headphones. Solo in Place and Mixdown Solo mode, which work in conjunction with the stereo output, are also provided. Monitor and solo functions are divided between two pages: Moni.Setup and Solo Setup. When the Solo function is off (i.e., [SOLO] button off), sources selected on the Moni.Setup page are output continuously.

Moni.Setup

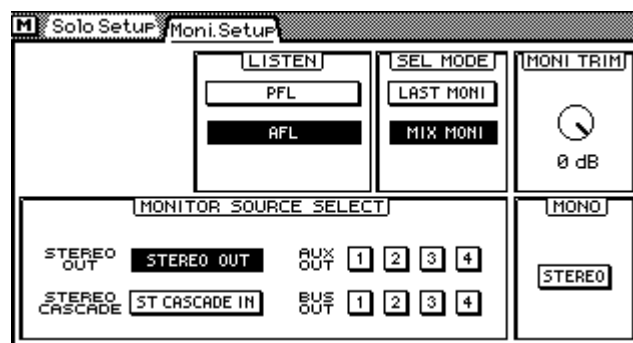

On the Moni.Setup page you can select the stereo output, aux sends, bus outs, or stereo cascade input as the monitor source. These signals are monitored via the monitor out and headphones. Moni.Setup page functions do not affect the [SOLO] button or stereo output. Using the SEL MODEs you can monitor these signals individually or mixed together. Signals can be sourced pre-fader (PFL) or post-fader (AFL). The Moni.Setup page also provides a trim control and mono/stereo switch. See Monitoring on page 74 for more information.

Solo

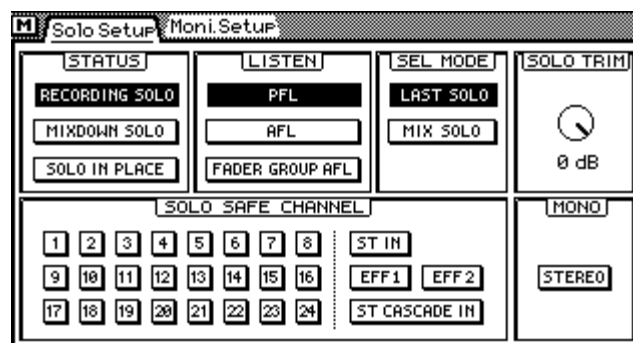

On the Solo Setup page you can set up the solo functions that allow you to monitor input channels, the stereo input channel, effects returns, and ST cascade input. Three solo modes are available on this page: Recording Solo, Mixdown Solo, and Solo in Place. These modes are used in conjunction with the [SOLO] and [ON] buttons, which are used to select channels. Using the SEL MODEs you can monitor these signals individually or mixed together. Signals can be sourced pre-fader (PFL) or post-fader (AFL). The Solo Setup page also provides a trim control and mono/stereo switch. The Solo Setup page is used only to set up the solo functions. You do not need to select it in order to use the solo functions. See Setting Up Solo on page 75 for more information. See also *Solo Safe* on page 77.

Monitor Outputs

Monitor and solo signals are output via the monitor out and phones connections. Mix-down Solo and Solo in Place modes also work with the stereo outputs.

The MONITOR OUT SOLO/2TR IN switch selects the signal source for the monitor out and phones, and should be set to SOLO for monitoring. See Two-track Input on page 77 for more information.

Monitor signals are converted to analog using 20-bit 8-times oversampling D/A converters, and then output via balanced 1/4-inch phone jacks with a +4 dB nominal output level.

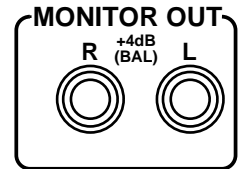

The MONITOR OUT LEVEL control is used to adjust the level of the monitor out signal.



Phones

A pair of stereo headphones can be connected to the PHONES stereo (TRS) phone jack. The phones signal is the same as the monitor out signal.



The PHONES LEVEL control is used to adjust the level of the phones signal.



Monitoring

On the Moni.Setup page you can select the stereo output, aux sends, bus outs, or stereo cascade input as the monitor source. These signals are monitored via the monitor out and phones. Functions on this page do not affect the [SOLO] button or stereo output.

1. Use the [SOLO SETUP] button to locate the Moni.Setup page shown below.

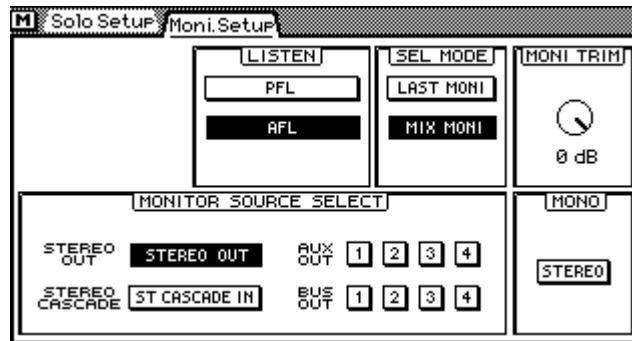

2. Use the cursor buttons to select the parameters, and the [ENTER] button and PARAMETER wheel to set them.

If you are using a mouse, simply click the switches and drag the rotary control.

MONITOR SOURCE SELECT—These switches are used to select the signal source for the monitor out and phones. You can select the stereo out, aux sends, bus outs, and the stereo cascade input. When aux sends or bus outs are configured as stereo pairs, these switches are linked.

LISTEN—These switches set the monitor signal source to pre-fader (PFL) or post-fader (AFL). This is a global setting that affects all monitor sources (i.e., stereo out, aux sends, etc).

SEL MODE—These switches set the monitor select mode. In LAST MONI mode, only one monitor source can be selected at a time. In MIX MONI mode, however, several monitor sources can be selected. Selected signals are mixed.

MONI TRIM—This control is used to adjust the level of the monitor signal from -60 dB to $+6$ dB. This control can be adjusted using the PARAMETER wheel regardless of cursor position.

STEREO/MONO—This switch sets the monitor and phone's signals to mono or stereo. It functions independently of the MONO switch on the Solo Setup page. When on, the left and right signals are summed together to form a mono mix. The level of the summed mix is attenuated -3 dB.

Setting Up Solo

The Solo Setup page is used to set up the solo functions used to monitor input channels, the stereo input channel, and effects returns. Three solo modes are available: Recording Solo, Mixdown Solo, and Solo in Place. These modes are used in conjunction with the [SOLO] and [ON] buttons, which are used to select channels. The Solo Setup page is used only to set up the solo functions. You do not need to select it in order to use the solo functions.

1. Use the [SOLO SETUP] button to locate the Solo Setup page shown below.

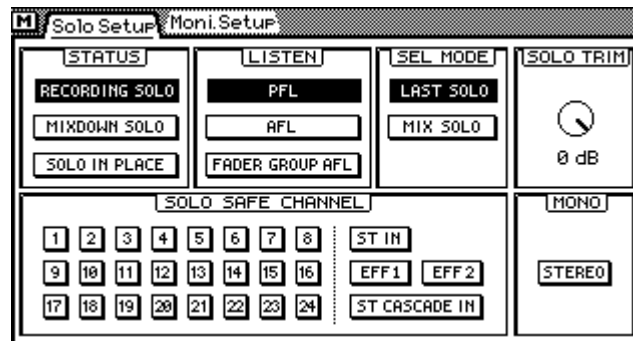

2. Use the cursor buttons to select the parameters, and the [ENTER] button and PARAMETER wheel to set them.

If you are using a mouse, simply click the switches and drag the rotary control.

STATUS—These switches are used to select the following solo modes: Recording Solo, Mixdown Solo, or Solo In Place.

Status	Description
Recording Solo	<ul style="list-style-type: none"> • Soloed channel signals are sent to the Solo bus and then output to the monitor out and phones. • This allows you to monitor channels that are not routed to a bus.
Mixdown Solo	<ul style="list-style-type: none"> • The Stereo bus signal is fed to the Solo bus and then output to the monitor out and phones (the stereo output, monitor out, and phones all output the same signal). • Only channels that are soloed are turned on. All other channels are muted. Solo safe channels remain as they were before solo mode was engaged. • Channels that were turned off before the [SOLO] button was pressed are turned on when soloed. This means that so long as they are routed to the Stereo bus they can be monitored.
Solo in Place (this mode is essentially a combination of the Recording and Mixdown Solo modes)	<ul style="list-style-type: none"> • Soloed channel signals are sent to the Solo bus and then output to the monitor out and phones. • This allows you to monitor channels that are not routed to a bus (same as for Recording Solo mode). • Soloed channels that are turned on are output as usual to destinations other than the monitors, just like when they are not soloed. Channels that are not soloed, however, are muted. Solo safe channels remain as they were before solo mode was engaged. This means that even channels that are not routed to a bus can be monitored (this is different to Mixdown Solo mode).

When 03Ds are cascaded together using YGDAI CD8-CS cascade cards, the status settings can be made only on the cascade master (IN setting), not the cascade slave (OUT setting).

LISTEN—These switches set the monitor signal source to pre-fader (PFL) or post-fader (AFL). This is a global setting that affects all input channels, the stereo input channel,

and effects returns. The third switch, FADER GROUP AFL, works with fader groups. When you solo a channel that is in a fader group, all other channels in that fader group are also soloed. See Fader Groups on page 112. These switches are not active in MIX-DOWN SOLO mode, because the monitor out and phones signals are sourced from the Stereo bus.

	Channel On/Off		Pair		Fader Group	
PFL	On	Pre-fader signal	Yes	Stereo	Yes	Only soloed channel
	Off		No	Mono	No	
AFL	On	Post-fader signal	Yes	Stereo	Yes	Only soloed channel
			No			
	Off	Pre-fader signal	Yes	Stereo	No	Only soloed channel
			No	Mono		
Fader Group AFL	On	Post-fader signal	Yes	Stereo	Yes	All channels in the same group as the soloed channel
	Off	Off	No		No	Only soloed channel

SEL MODE—These switches set the monitor select mode. In LAST SOLO mode, only one monitor source can be selected at a time. In MIX SOLO mode, however, several monitor sources can be selected. Selected signals are mixed.

SOLO TRIM—This control is used to adjust the level of the solo signal from -60 dB to $+6$ dB. This control is not active in MIXDOWN SOLO mode, because the monitor out and phones signals are sourced from the Stereo bus. This control can be adjusted using the PARAMETER wheel regardless of cursor position.

STEREO/MONO—This switch sets the monitor and phone's signals to mono or stereo. It functions independently of the MONO switch on the Moni.Setup page. When on, the left and right channels of the stereo signal are summed together to form a mono mix. The level of the summed mix is attenuated -3 dB.

Using Solo

1. **Make sure the MONITOR OUT SOLO/2TR IN switch is set to SOLO.**
2. **Set the MONITOR OUT LEVEL control midway.**
If you are using headphones, set the PHONES LEVEL control midway.
3. **Set up the solo functions on the Solo Setup page. See Setting Up Solo on page 75 for more information.**
4. **Press the [SOLO] button.**
The SOLO indicator on the display and the [SOLO] and [ON] button indicators flash. The [ON] buttons now function as solo select buttons, not channel on/off buttons.
The stereo output, aux send, and bus out [ON] buttons do not flash. To monitor these outputs, use the Moni.Setup page. See Monitoring on page 74 for more information.
5. **Use the [ON] buttons to solo channels.**
Exact operation depends on the Solo Setup settings. See Setting Up Solo on page 75 for more information.
The last channel soloed becomes the currently selected channel, and that channel's [SEL] button lights up. So with the View page selected you can instantly see the settings of the soloed channel without having to select it using the [SEL] button. Channels configured as stereo pairs are selected together.

Solo Safe

The Solo Safe function is used to protect channels from being muted when the MIX-DOWN SOLO or SOLO IN PLACE mode is used. A safe channel is not muted when other channels are soloed. The input channels, stereo input channel, effects returns, and stereo cascade input can be set as safe channels. Solo safe settings are made on the Solo Setup page.

1. Use the [SOLO SETUP] button to locate the Solo Setup page shown below.

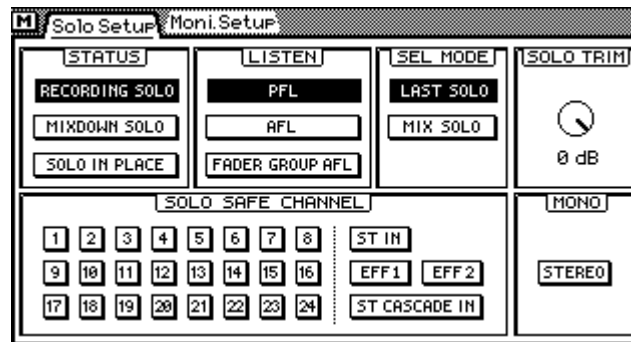

2. Use the cursor buttons to select the SOLO SAFE CHANNEL switches, and the [ENTER] button to set them.

If you are using a mouse, simply click the SOLO SAFE CHANNEL switches.

Input channels configured as stereo pairs cannot be set individually.

A channel is set as safe when its SOLO SAFE CHANNEL switch is highlighted.

Two-track Input

The 03D two-track input can be used for confidence monitoring while recording a stereo mix to a master machine. When the MONITOR OUT SOLO/2TR IN switch is set to SOLO, solo signals are fed to the monitor out and phones connections. When it is set to 2TR IN, however, the signal connected to the 2TR IN jacks is output. The levels of the two-track signal being monitored can be set using the MONITOR OUT and PHONES LEVEL controls.

The 2TR INs are phono jacks with a -10 dBV nominal input level.

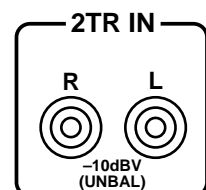
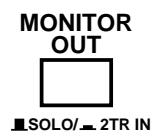

Solo Block Diagram

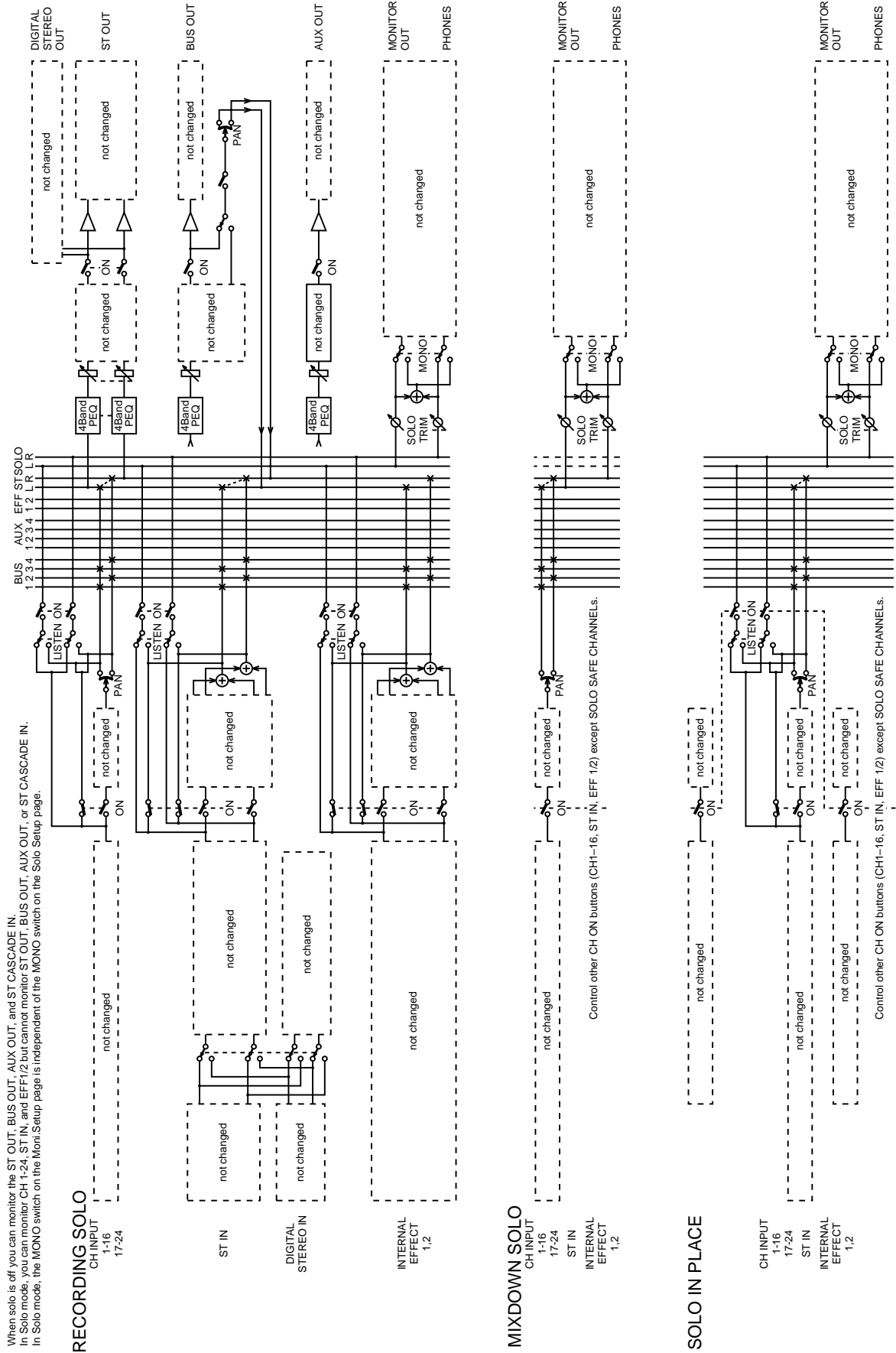

Metering

Level meters for the 24 input channels, stereo input channel, aux sends, bus outs, effects returns, YGDAI outputs, and Solo bus are provided on the three Meter pages. The signal source points for input and output meters can be set on Pre/Post page. Meters can be used to meter signal levels or the amount of gain reductions being applied by the dynamics processors. Stereo out levels are metered using the dedicated L STEREO R LED meters. A switchable peak hold function can be set globally for all meters.

Meter page level meters range from -48 dB to 0 dB, with CLIP. The CLIP indicators light up when signals actually clip. So if a CLIP indicator lights up, back off the level a little. Otherwise, signal distortion may occur.

1. Use the [FADER] button to select the Meter pages.

The CH 1-16 page, which is shown below, contains level meters for input channels 1 to 16, the stereo input channel, and effects returns 1 and 2. The decibel value below each meter indicates the position of the corresponding channel fader. The position of the stereo out fader appears in the ST OUT LEVEL box.

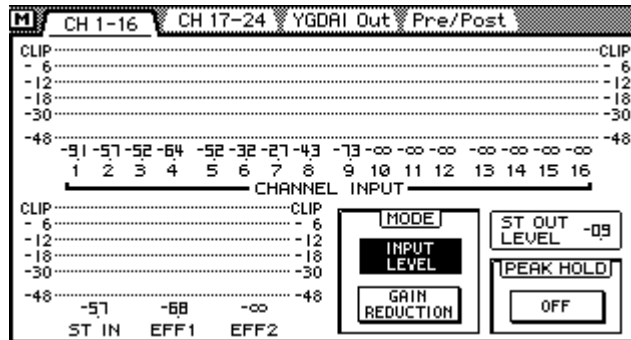

2. Use the cursor buttons to select a MODE switch, and then press the [ENTER] button to activate that mode.

If you are using a mouse, simply click a MODE switch.

MODE—Level meters can be used as input levels meters or gain reduction meters. In INPUT LEVEL mode, meters function as typical level meters. In GAIN REDUCTION mode, the meters show the amount of gain reduction being applied by the dynamics processors. Gain reduction meters are also available on the Dyn. Edit page. See Dynamics Processors on page 143 for more information.

The MODE switches also appear on the CH 17-24 meter page.

On the following display page, the meter mode is set to gain reduction and the noise gate patched into channel 5 is shown as being closed.

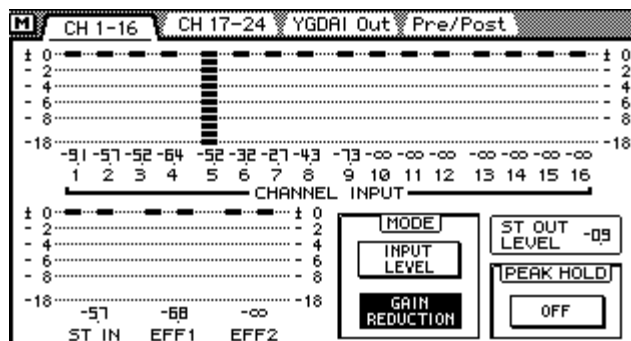

- Use the cursor buttons to select the **PEAK HOLD** switch, and then press the **[ENTER]** button to activate the peak hold function.

If you are using a mouse, simply click the **PEAK HOLD** switch.

PEAK HOLD—This switch is used to turn on and off the Peak Hold function for the Meter pages and the L STEREO R meters. When Peak Hold is ON, the meter segments lit by the loudest signal peaks remain on, providing an easy way to check for peak levels. To turn these meter segments off, set the **PEAK HOLD** switch to OFF. When the meter mode is changed, the Peak Hold function is reset. Peak Hold for the Solo and stereo meters is not affected.

The **PEAK HOLD** switch also appears on the CH 17–24, and YGDAI meter pages.

The following CH 17–24 meter page contains level meters for input channels 17 to 24, the aux sends, and the bus outs. The stereo input channel and effects returns 1 and 2 meters also appear on this page. The decibel value below each meter indicates the position of the corresponding channel fader. The position of the stereo out fader appears in the **ST OUT LEVEL** box.

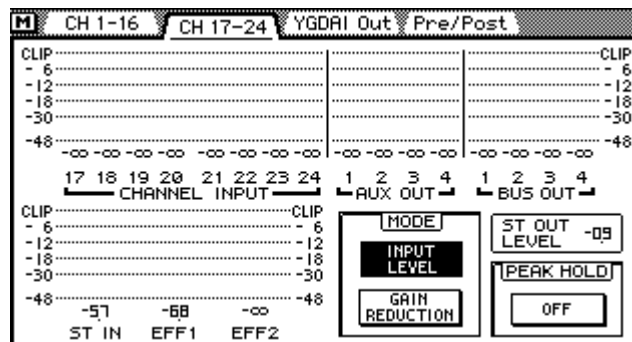

The following YGDAI Out meter page contains level meters for the eight YGDAI outputs and Solo bus. The boxes below the YGDAI output meters show which signals are assigned to the YGDAI outputs. See Assigning Signals to the YGDAI Outputs on page 224 for more information. When the meter mode is set to **GAIN REDUCTION**, peak hold for the XGDAI output meters is reset when the CH 1–16 or CH 17–24 meter page is selected.

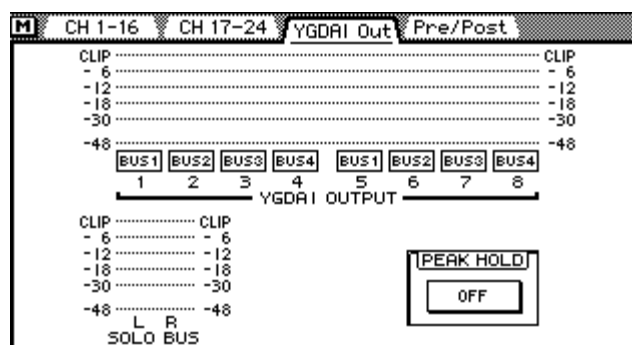

The following Pre/Post meter page is used to select the signal source points for the input and output meters. The Peak Hold function is reset whenever you select another source point.

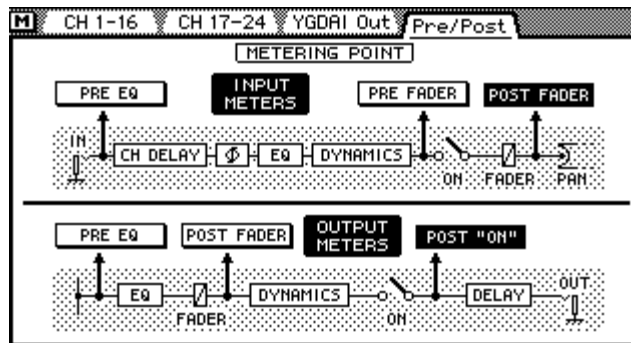

4. Use the cursor buttons to select a meter point switch, and then press the [ENTER] button to activate it.

If you are using a mouse, simply click the meter point switches.

INPUT METERS—The meter source point for the 24 input channels, stereo input channel, and effects returns can be set as PRE EQ, PRE FADER, or POST FADER.

OUTPUT METERS—The meter source point for the aux sends, and bus outs can be set as PRE EQ, POST FADER, or POST ON.

Signal & Peak Indicators

Signal and peak indicators for all inputs and outputs are available at the top of the display. These indicators are always available and are not affected by the display pages. There are two sets of signal and peak indicators. One for input channels 1 to 16, the stereo input channel, and effects returns. The other for input channels 17 to 24, the aux sends, and the bus outs. The stereo input channel and effects returns indicators appear in both sets. These sets are switched automatically when the mixing layer is changed.

When the 1–16 Mixing Layer is selected, peak and signal indicators for input channels 1 to 16, the stereo input channel, and effects returns appear, as shown below.

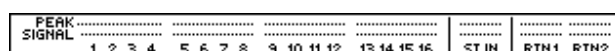

When the 17–24/MASTER Mixing Layer is selected, peak and signal indicators for input channels 17 to 24, the aux sends, and the bus outs appear.

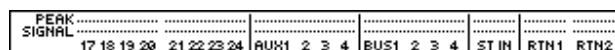

The SIGNAL indicators light up when a signal level of –24 dB is detected, and are intended to show that a signal is present.

The PEAK indicators light up when the signal level reaches –3 dB.

Main Stereo Meters

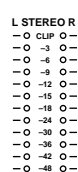

Stereo output signals are metered using the dedicated 12-segment LED bar-type meters next to the display. The meters range from –48 dB to 0 dB. The CLIP LED lights when the signal actually clips. If a CLIP LED does light, lower the ST OUT level using the ST OUT fader to prevent signal distortion. The PEAK HOLD ON/OFF switch on the Meter pages also sets the peak hold function for the L STEREO R meters.

Monitor Block Diagram

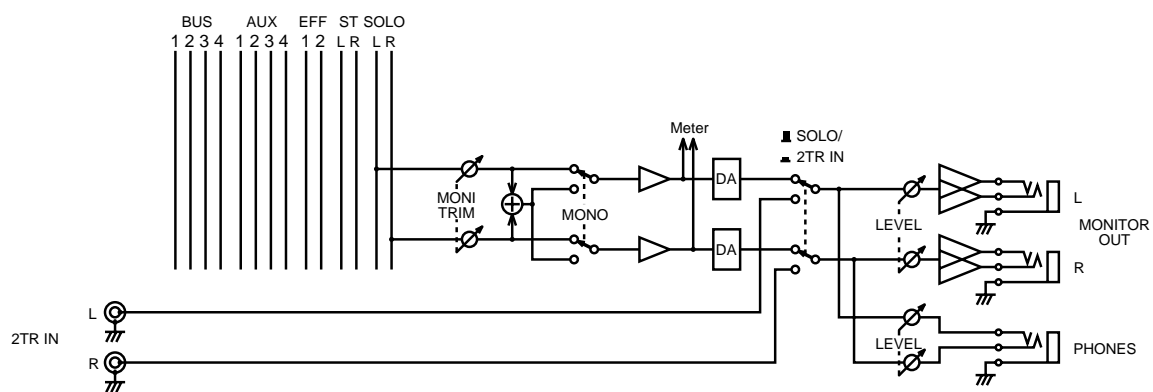

Stereo Output

8

In this chapter...

About the Stereo Output	84
Analog Stereo Outputs	84
DIGITAL STEREO OUT	84
Stereo Output & the YGDAI Interface	84
Rec Out & the Stereo Output	84
Monitoring the Stereo Output	84
Metering the Stereo Output	84
Routing Signals to the Stereo Output	84
Setting the Stereo Output Level	85
Muting the Stereo Output	85
Balancing the Stereo Output	85
Applying EQ to the Stereo Output	85
Stereo Output Dynamics Processor	85
Stereo Output Delay	86
Stereo Output Block Diagram	87

About the Stereo Output

The stereo output signal can be output to analog XLR-type connectors, analog REC OUT connectors, YGDAI digital outputs, or AES/EBU and COAXIAL digital outputs. The stereo output features four-band parametric EQ and a dynamics processor.

Analog Stereo Outputs

The stereo output signal is converted to analog using 20-bit 8-times oversampling D/A converters, and then output via balanced XLR-3-32-type connectors with a +4 dB nominal output level.

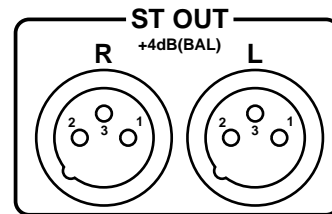

DIGITAL STEREO OUT

The stereo output signal can also be output digitally via the DIGITAL STEREO OUT connectors. Two connectors are available: one for AES/EBU format and one for COAXIAL format. See Digital Stereo Out on page 219 for more information.

Stereo Output & the YGDAI Interface

In addition to the analog stereo outputs and DIGITAL STEREO OUTs, stereo signals can be output via the YGDAI digital outputs. See YGDAI Cards on page 223 for more information.

Rec Out & the Stereo Output

The stereo output signal can be sent to the REC OUT connectors. These are phono jacks with a -10 dBV nominal output level. The REC OUT connectors can also be used to output signals from bus outs 1 and 2. The REC OUT SOURCE SELECT switch is used to select the signal source.

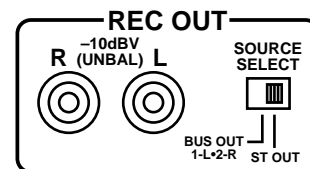

Solo & the Stereo Output

The Solo in Place and Mixdown Solo modes work in conjunction with the stereo output. See Setting Up Solo on page 75 for more information.

Monitoring the Stereo Output

See Solo, Monitors & Meters on page 71 for more information.

Metering the Stereo Output

Stereo output signal levels are metered using the 12-segment LED meters. See Metering on page 79 for more information.

Routing Signals to the Stereo Output

Input channel, stereo input channel, and effects return signals can be routed to the stereo output. See Stereo Pan, Balance & Routing on page 59 for more information.

Setting the Stereo Output Level

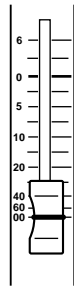

The stereo output level is controlled using the ST OUT fader. This fader is not affected by the Mixing Layer, and always works as level control for the stereo output.

Muting the Stereo Output



The stereo output can be muted using the ST OUT [ON] button. This button contains an indicator that lights up when stereo output is on. The ST OUT [ON] button is not affected by the Mixing Layer setting or [SOLO] function.

Balancing the Stereo Output

The left and right channels of the stereo output signal can be balanced using the ST OUT balance control on the page shown below.

1. Use the [PAN/ROUTING] button to locate the page shown below.

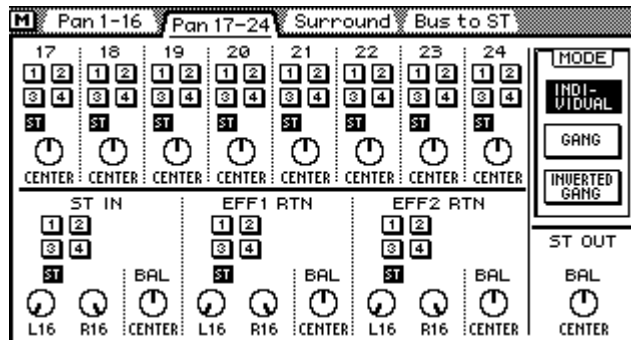

2. Use the cursor buttons to select the ST OUT BAL control and the PARAMETER wheel to adjust it.

If you are using a mouse, position the mouse cursor over the balance control, press and hold the left mouse button, and then drag the mouse.

Applying EQ to the Stereo Output

The stereo output features stereo four-band parametric EQ. See EQ on page 45 for more information.

Stereo Output Dynamics Processor

The stereo output features a stereo dynamics processor. See Dynamics Processors on page 143 for more information.

Stereo Output Delay

The left and right signals of the analog stereo output can be delayed individually. This can be used to compensate for delays in multi-speaker sound reinforcement systems.

1. Use the [DELAY/∅] button to locate the CH Delay page.
2. Press the ST OUT [SEL] button.

The CH Delay page shown below appears.

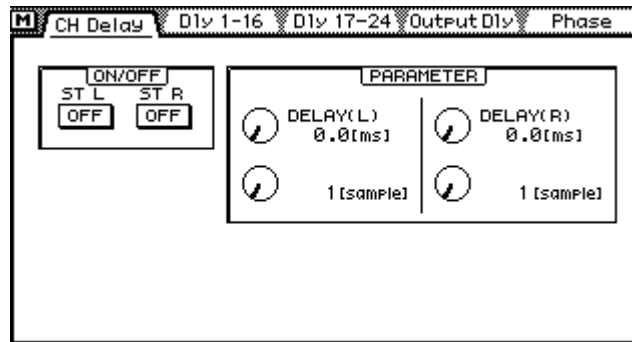

3. Use the cursor buttons to select the delay parameters and the [ENTER] button and PARAMETER wheel to set them.

If you are using a mouse, simply click the switches and drag the rotary controls.

ON/OFF—These switches are used to turn on and off the delays. When the cursor is located within the PARAMETER window, the [ENTER] button can be used to turn on and off the delays without having to select the ON/OFF switch.

PARAMETER—These controls are used to set the delay time. Delay can be specified in either seconds or samples. The maximum delay is 2,000 samples. The actual delay in seconds depends on the sampling rate: 45.4 milliseconds at a sampling rate of 44.1 kHz, and 41.7 milliseconds at a sampling rate of 48 kHz.

Viewing Stereo Output Delay Settings

Stereo output delay settings can be viewed on the following page.

1. Use the [DELAY/∅] button to locate this page.

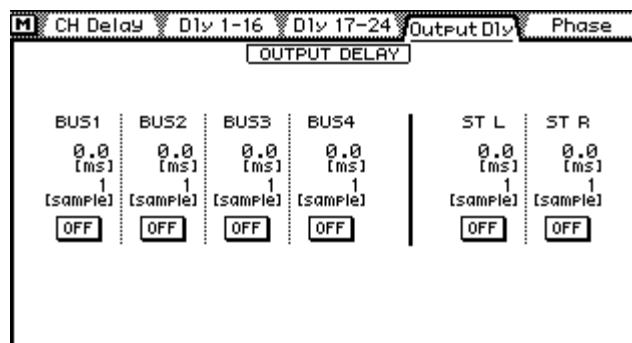

This page shows the delay time set for the left and right channels of the stereo output. The delay time cannot be changed on this page. Delays can, however, be turned on and off.

2. Use the ST OUT [SEL] button to select the stereo output channels and the [ENTER] button to turn the delays on and off.

If you are using a mouse, simply click the switches. The switches can also be selected using the cursor buttons.

Stereo Output Block Diagram

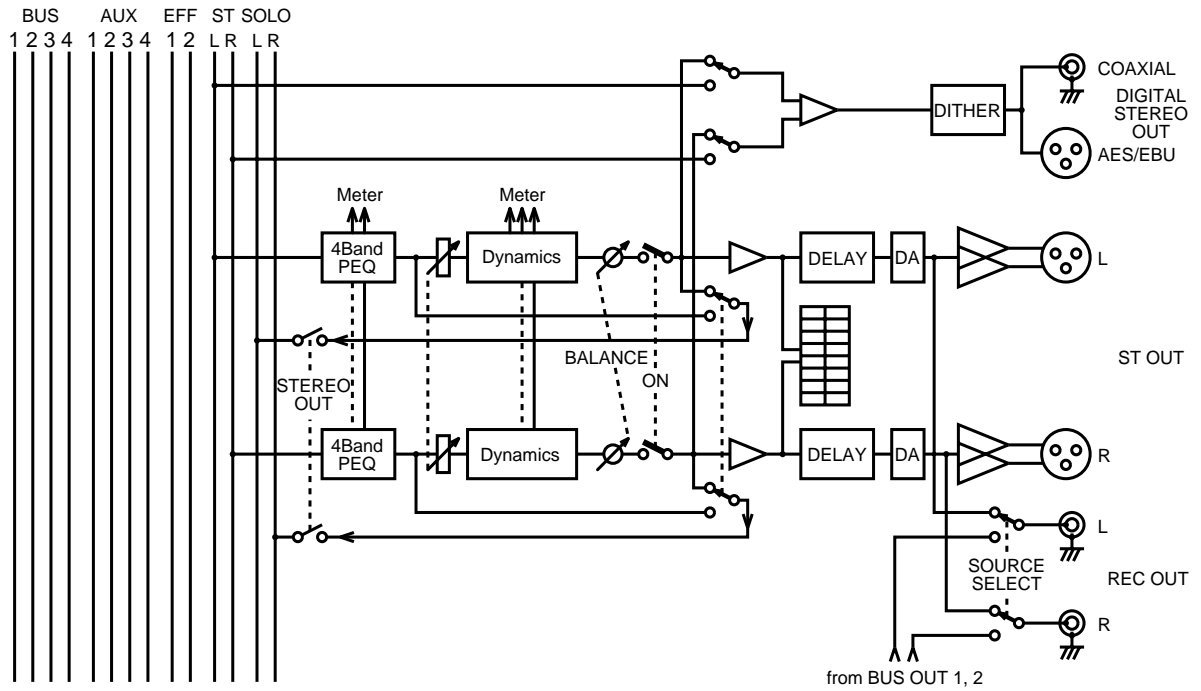

Aux Sends

9

In this chapter...

About Aux Sends	90
Analog Aux Send Outputs	90
Aux Sends & the YGDAI Interface	90
Monitoring Aux Sends	90
Metering Aux Sends	90
Sending Channel Signals to Aux Sends	91
Pre-fader/Post-fader Aux Sends	92
Setting Aux Send Master Levels	93
Muting Aux Sends	93
Applying EQ to Aux Sends	93
Aux Send Dynamics Processors	93
Aux Send Stereo Pairs	94
Aux Send Block Diagram	95

About Aux Sends

The 03D features four aux sends. Input channel, stereo input channel, and effects return signals can be fed to the four aux sends. Each aux send features four-band parametric EQ and a dynamics processor. Aux sends can be used individually or in stereo pairs. Aux send signals are output via analog phone jacks. They can also be output via the YGDAI digital outputs.

The 03D does not have dedicated aux return inputs. Use the input channels or stereo input channel to return aux signals.

The onboard effects are explained in their own chapter. See Onboard Effects on page 117 for more information.

Analog Aux Send Outputs

Aux send signals are converted to analog using 18-bit D/A converters, and then output via balanced 1/4-inch phone jacks with a +4 dB nominal output level.

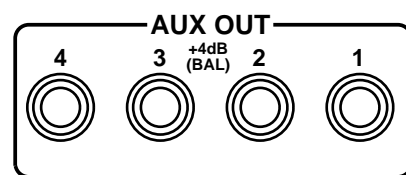

Aux Sends & the YGDAI Interface

In addition to the analog aux send outputs, aux send signals can be output via the YGDAI digital outputs. See YGDAI Cards on page 223 for more information.

Monitoring Aux Sends

See Solo, Monitors & Meters on page 71 for more information.

Metering Aux Sends

Aux send signal levels can be metered on the Meter pages. See Metering on page 79 for more information.

Sending Channel Signals to Aux Sends

Input channel, stereo input channel, and effects return signals can be sent to aux sends.

1. **Use the [MIXING LAYER] button to select the 17–24/MASTER Mixing Layer. See Mixing Layer on page 31 for more information.**

Faders 9 to 12 now function as master level controls for aux sends 1 to 4.

2. **Set the fader of the aux send you are using to 0.**

The master level can be adjusted again later.

3. **Use the [MIXING LAYER] button to select the Mixing Layer containing the source channel: 1–16 or 17–24/MASTER.**

If the source is the stereo input channel, you can ignore this step because the ST IN fader is unaffected by the Mixing Layer setting. Similarly, if the source is an effects return channel, use the EFFECT RETURN [SEL] button to select effects return 1 or 2.

4. **Use the [AUX] buttons to select an aux send.**

The faders now function as channel aux send controls for the selected aux send.

5. **Raise the fader of the source channel.**

The source channel's signal is output via the aux send.

If the aux send is configured as a post-fader send, you'll also have to raise the channel fader in order to send the signal to the aux send. See Pre-fader/Post-fader Aux Sends on page 92 for more information.

When channels are configured as a stereo pair using the Pair function (*Stereo Pairs* on page 114), aux send level controls are linked, and adjustments can be made with either channel selected. You cannot set different aux settings for the odd and even channels in a stereo pair.

Pre-fader/Post-fader Aux Sends

Individual input channels, the stereo input channel, and effects return aux sends can be configured as either pre-fader or post-fader sends. These settings are made on the Aux Pre/Post pages. Each aux send has its own Pre/Post page.

1. Use the [AUX] buttons to locate the Pre/Post pages for aux sends 1 to 4.

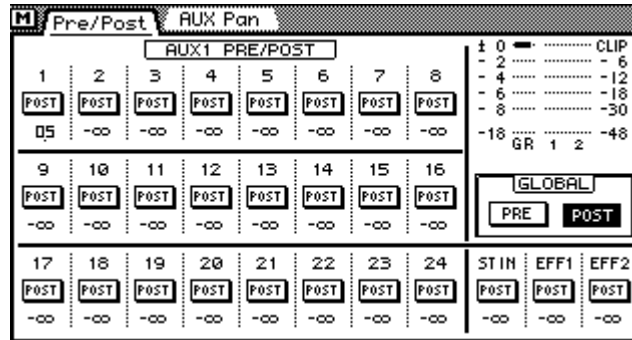

The meters show the level of the selected aux send and the amount of gain reduction. The values below the PRE/POST switches indicate the aux send fader positions.

2. Use the cursor buttons to select the PRE/POST switches and the [ENTER] button to set them.
If you are using a mouse, simply click the PRE/POST switches.
3. To set all PRE/POST switches to either pre or post, select the GLOBAL PRE or POST switch and press the [ENTER] button.
If you are using a mouse, simply click the GLOBAL switches.

When channels are configured as a stereo pair using the Pair function (*Stereo Pairs* on page 114), pre/post settings are linked, and adjustments can be made with either channel selected. You cannot set different pre/post settings for the odd and even channels in a stereo pair.

Setting Aux Send Master Levels

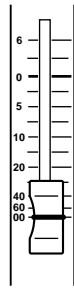

Aux send master levels are controlled using faders 9 to 12. The function of these faders depends on the selected Mixing Layer. See *Faders* on page 32 for more information.

1. Use the [MIXING LAYER] button to select the 17–24/MASTER Mixing Layer.

Faders 9 to 12 now function as aux send master level controls.

2. Use faders 9 to 12 to adjust the aux send levels.

When aux sends are configured as a stereo pair using the Pair function (*Stereo Pairs* on page 114), the faders of the two sends work together, and either fader can be used to adjust the aux send master level.

Muting Aux Sends



Aux sends can be muted using [ON] buttons 9 to 12. These buttons contain indicators that light up when an aux send is on.

1. Use the [MIXING LAYER] button to select the 17–24/MASTER Mixing Layer.

[ON] buttons 9 to 12 now function as aux send mute switches.

2. Press the [ON] buttons.

Press the [ON] button again to unmute an aux send.

When aux sends are configured as a stereo pair using the Pair function (*Stereo Pairs* on page 114), the [ON] buttons of the two sends work together, and either button can be used to mute the aux send masters.

Applying EQ to Aux Sends

Each aux send features four-band parametric EQ. See *EQ* on page 45 for more information.

Aux Send Dynamics Processors

Each aux send features a dynamics processor. See *Dynamics Processors* on page 143 for more information.

Aux Send Stereo Pairs

Aux sends 1/2 and aux sends 3/4 can be configured as stereo pairs. Aux send stereo pairs are configured on the Pair page. See Stereo Pairs on page 114 for more information. When aux sends are paired, the following aux send master parameters are linked: EQ, faders, dynamics processors, [ON] buttons, and monitor. Since these parameters are linked, you can adjust the master controls of either aux send in a stereo pair. In addition, aux send pan controls are activated on the input channels, stereo input channel, and effects returns. The aux send pan controls are available on the AUX Pan pages. Two AUX Pan pages are available: one for aux pair 1/2 and one for aux pair 3/4.

If you select an AUX Pan page and the respective aux sends are not configured as a stereo pair, an AUX Pan page like the one shown below appears.

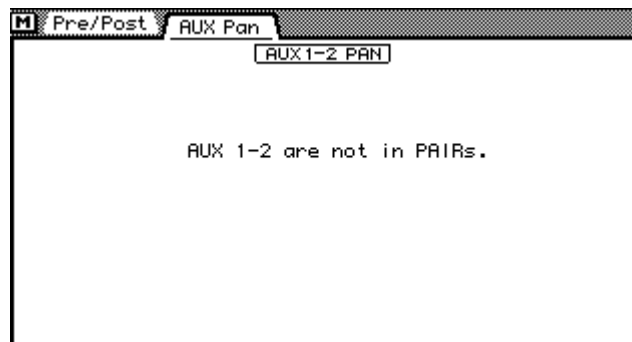

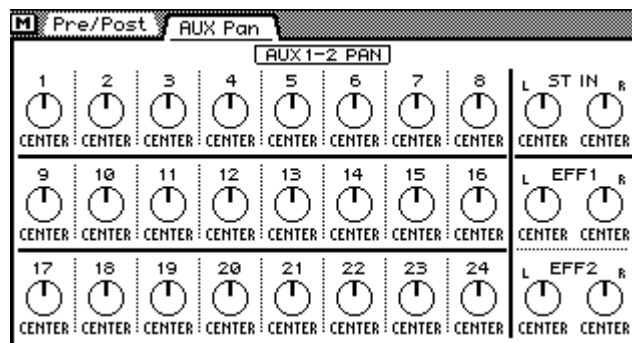

When aux sends are configured as a stereo pair (*Stereo Pairs* on page 114), an AUX Pan page like the one shown below appears.

1. Use the [AUX 1] or [AUX 2] button to locate the AUX 1–2 Pan page, or the [AUX 3] or [AUX 4] button to locate the AUX 3–4 Pan page.



2. Use the [SEL] and [MIXING LAYER] buttons to select a channel. See Mixing Layer on page 31 for more information.
3. Use the cursor buttons to select the pan controls and the PARAMETER wheel to set them.

If you are using a mouse, position the mouse cursor over a pan control, press and hold the left mouse button, and then drag the mouse.

-  Input channels 1 to 24 use a single pan control to pan signals between the paired aux buses.
-  The stereo input channel and effects returns have two pan controls: one for the left signal and one for the right. These pan controls can be used to adjust the width of stereo signals.

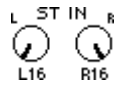

With the left control set at L16 and the right control set at R16, as shown, the width of a stereo signal is 100%.



With both controls set at CENTER, as shown, the width of a stereo signal is reduced to zero.



Setting the controls to positions in between these two extremes allows you set the width of the stereo signal from zero to 100%. To maintain a central balance, however, you must set both controls to corresponding values. For example, L5 and R5, or L10 and R10.

Including center, there are 33 pan positions.

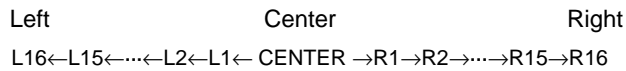

Aux send pan controls are not affected by the Individual, Gang, and Inverted Gang pan modes found on the Pan 1–16 and Pan 17–24 pages.

Aux Send Block Diagram

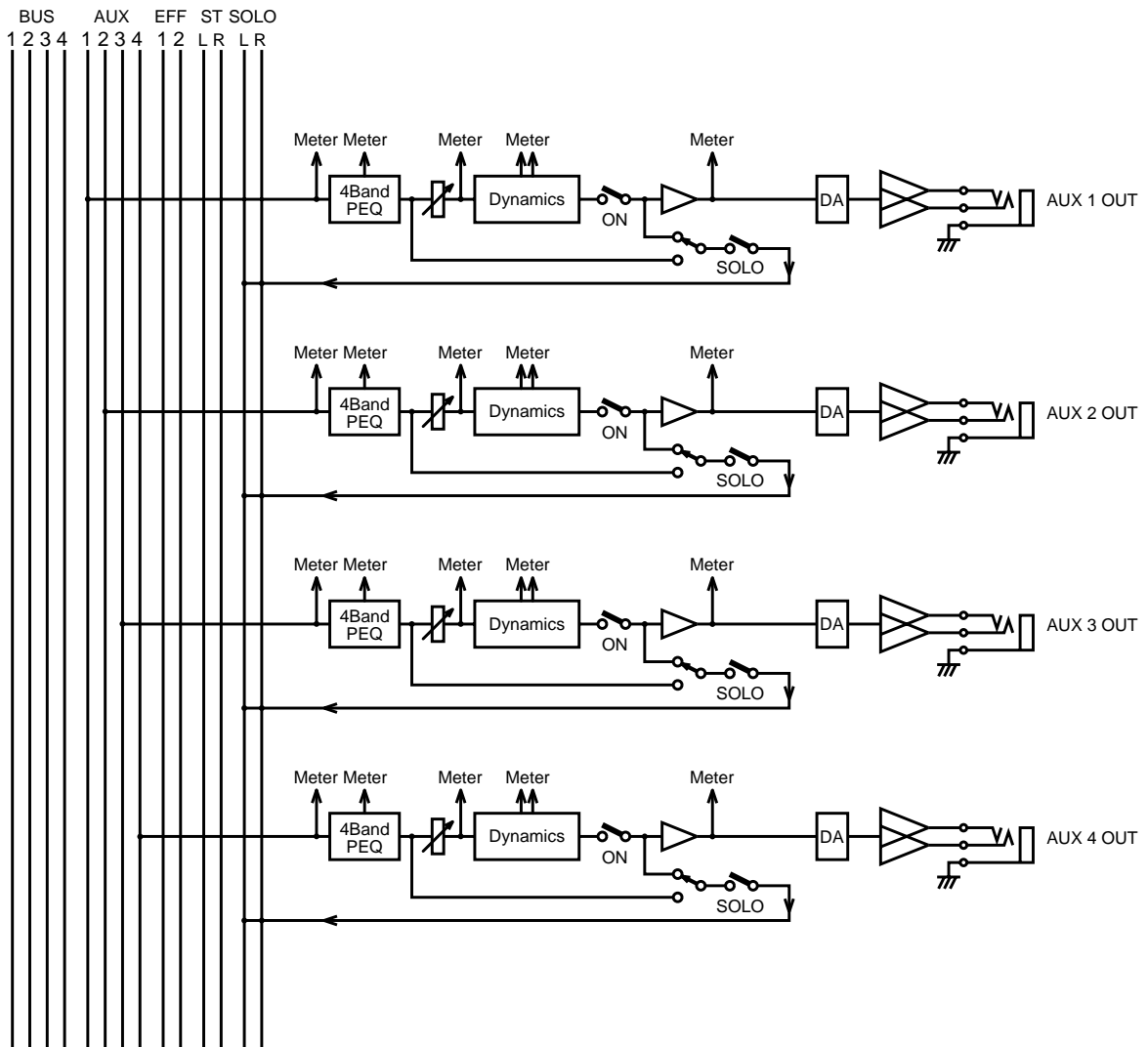

Bus Outs

10

In this chapter...

About Bus Outs	98
Analog Bus Outs	98
Bus Outs & the YGDAI Interface	98
Rec Out & Bus Outs 1 & 2	98
Monitoring Bus Outs	98
Metering Bus Outs	98
Routing Signals to Bus Outs	98
Setting Bus Out Master Levels	99
Muting Bus Outs	99
Applying EQ to Bus Outs	99
Bus Out Dynamics Processors	99
Bus Out Delay	100
Routing Bus Signals to the Stereo Bus	101
Bus Out Stereo Pairs	101
Bus Out Block Diagram	102

About Bus Outs

The 03D features four bus outputs. Input channel, stereo input channel, and effects return signals can be routed to the four buses. Each bus out features four-band parametric EQ and a dynamics processor. Bus outs can be used individually or in stereo pairs. Bus signals are output via analog phone jacks. They can also be output via the YGDAI digital outputs.

Analog Bus Outs

Bus out signals are converted to analog using 18-bit D/A converters, and then output via balanced 1/4-inch phone jacks with a +4 dB nominal output level.

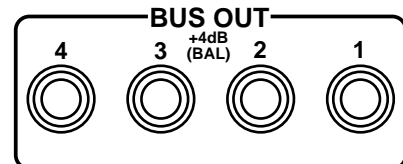

Bus Outs & the YGDAI Interface

In addition to the analog bus outs, bus out signals can be output via the YGDAI digital outputs. See YGDAI Cards on page 223 for more information.

Rec Out & Bus Outs 1 & 2

Signals from bus outs 1 and 2 can be sent to the REC OUT connectors. These are phono jacks with a -10 dBV nominal output level. The bus out 1 signal is sent to the left REC OUT, and bus out 2 signal is sent to the right REC OUT. The REC OUT connectors can also be used to output the stereo output signal. The REC OUT SOURCE SELECT switch is used to select the signal source.

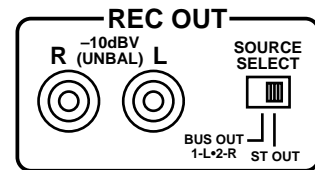

Monitoring Bus Outs

See Solo, Monitors & Meters on page 71 for more information.

Metering Bus Outs

Bus out signal levels can be metered on the Meter pages. See Metering on page 79 for more information.

Routing Signals to Bus Outs

Input channel, stereo input channel, and effects return signals can be routed to buses 1 to 4. See Stereo Pan, Balance & Routing on page 59 for more information.

Setting Bus Out Master Levels

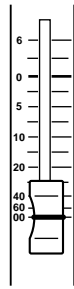

Bus out master levels are controlled using faders 13 to 16. The function of these faders depends on the selected Mixing Layer. See *Faders* on page 32 for more information.

1. Use the [MIXING LAYER] button to select the 17–24/MASTER Mixing Layer.

Faders 13 to 16 now function as bus out master level controls.

2. Use faders 13 to 16 to adjust the bus out levels.

When bus outs are configured as a stereo pair using the Pair function (*Stereo Pairs* on page 114), the faders of the two bus outs work together, and either fader can be used to adjust the bus out master level.

Muting Bus Outs



Bus outs can be muted using [ON] buttons 13 to 16. These buttons contain indicators that light up when a bus out is on.

1. Use the [MIXING LAYER] button to select the 17–24/MASTER Mixing Layer.

[ON] buttons 13 to 16 now function as bus out mute switches.

2. Press the [ON] buttons.

Press the [ON] button again to unmute a bus out.

When bus outs are configured as a stereo pair using the Pair function (*Stereo Pairs* on page 114), the [ON] buttons of the two bus outs work together, and either button can be used to mute the bus outs.

Applying EQ to Bus Outs

Each bus out features four-band parametric EQ. See *EQ* on page 45 for more information.

Bus Out Dynamics Processors

Each bus out features a dynamics processor. See *Dynamics Processors* on page 143 for more information.

Bus Out Delay

Analog bus out signals can be delayed individually. This can be used to compensate for delays in multi-speaker sound reinforcement systems.

1. Use the [DELAY/∅] button to locate the CH Delay page.
2. Use the [MIXING LAYER] button to select 17–24/MASTER.
3. Use the [SEL] buttons to select a bus out.

The CH Delay page shown below appears.

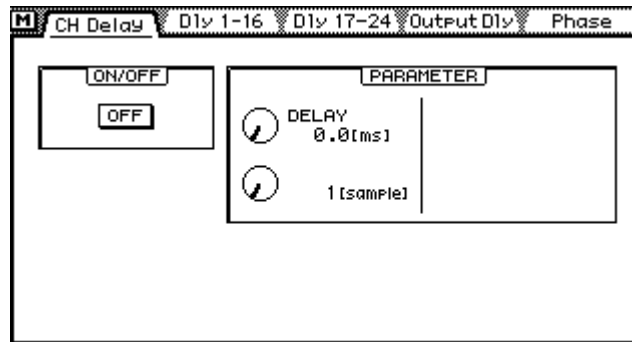

4. Use the cursor buttons to select the delay parameters and the [ENTER] button and PARAMETER wheel to set them.

If you are using a mouse, simply click the switches and drag the rotary controls.

ON/OFF—This switch is used to turn on and off the delay. When the cursor is located within the PARAMETER window, the [ENTER] button can be used to turn on and off the delay without having to select the ON/OFF switch.

PARAMETER—These controls are used to set the delay time. Delay can be specified in either seconds or samples. The maximum delay is 2,000 samples. The actual delay in seconds depends on the sampling rate: 45.4 milliseconds at a sampling rate of 44.1 kHz, and 41.7 milliseconds at a sampling rate of 48 kHz.

Viewing Bus Out Delay Settings

Bus out delay settings can be viewed on the following page.

1. Use the [DELAY/∅] button to locate this page.

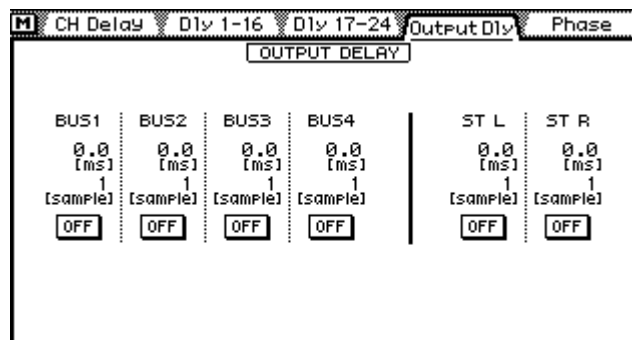

This page shows the delay time set for each bus out. The delay time cannot be changed on this page. The delays can, however, be turned on and off.

2. Use the [SEL] buttons to select bus outs and the [ENTER] button to turn the delays on and off.

If you are using a mouse, simply click the switches. The switches can also be selected using the cursor buttons.

Routing Bus Signals to the Stereo Bus

Bus out signals can be routed to the Stereo bus, allowing the bus outs to be used as sub-groups during mixdown. Bus to Stereo bus settings are made on the Bus to ST page. The Bus to ST page is available only when the pan mode is set to stereo. When a surround pan mode is selected, this function is not active. See Selecting a Pan Mode on page 58 for more information.

1. Use the [PAN/ROUTING] button to locate the Bus to ST page shown below.

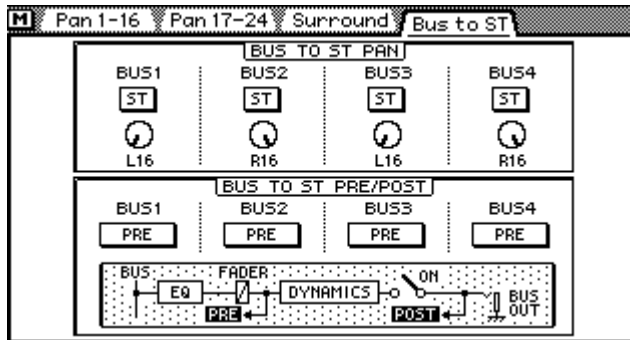

2. Use the cursor buttons to select the switches and controls, and the [ENTER] button and PARAMETER wheel to set them.

If you are using a mouse, simply click the switches. For pan, position the mouse cursor over a pan control, press and hold the left mouse button, and then drag the mouse.

BUS TO ST PAN—This window contains on/off (ST) switches and pan controls for each bus out. The ST switches are used to assign bus signals to the Stereo bus. A bus is assigned when its switch is highlighted. The pan controls are used to pan the bus signals across the Stereo bus. Including center, there are 33 pan positions.

Left Center Right
L16←L15←...←L2←L1← CENTER →R1→R2→...→R15→R16

BUS TO ST PRE/POST—This window contains pre/post switches for each bus. The bus to Stereo bus signal source can be either pre-dynamics or post dynamics, as shown by the block diagram located below the switches.

Bus Out Stereo Pairs

Bus outs 1/2 and bus outs 3/4 can be configured as stereo outputs. Bus out stereo pairs are configured on the Pair page. See Configuring Stereo Pairs on page 114 for more information. When bus outs are paired, the following bus out master parameters are linked: EQ, faders, dynamics processors, [ON] buttons, monitor, bus to stereo pre/post, and bus to stereo on/off. Since these parameters are linked, you can adjust the master controls of either bus out in a stereo pair.

Bus Out Block Diagram

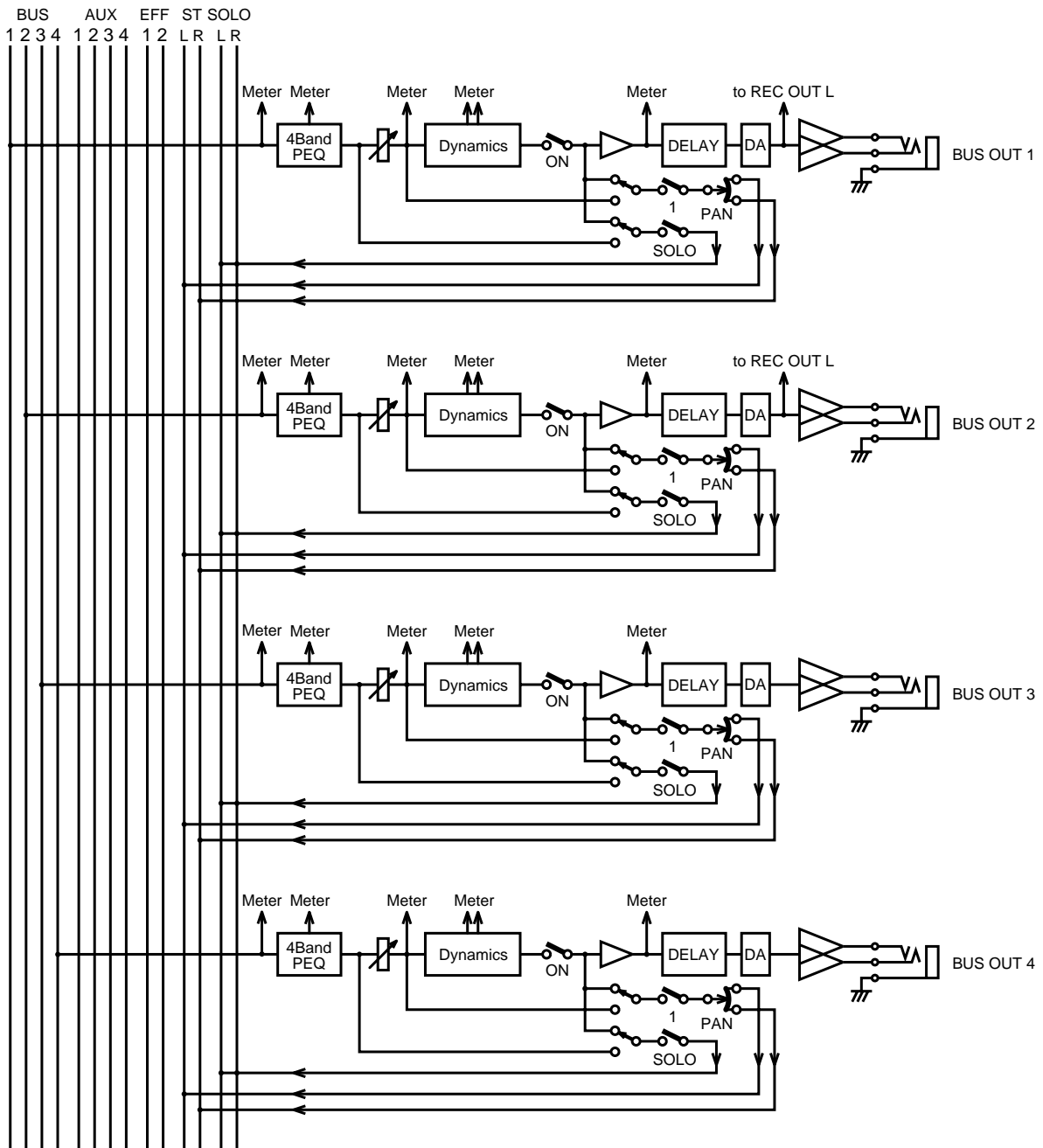

Channel Library & View

11

In this chapter...

Channel Library	104
Storing Channel Programs	105
Recalling Channel Programs	106
Editing Channel Program Titles	107
Channel View	108

Channel Library

Channel settings can be stored as programs in the channel library. The channel library contains two preset programs (00 and 01) and 49 user programs (02–50). User programs allow you to store frequently used channel settings, and they can be titled for easy identification. The channel library can also be used to transfer settings from one channel to another. For example, the input channel 1 settings could be stored as a library program and then recalled to input channel 19.

The preset programs contain the initial settings for all input and output channels, and can be used to reset these channels to their initial settings. Program 00, Reset (–∞dB), resets the selected channel and sets its fader to the ∞ dB (infinity) position. Program 01, Reset (0dB), does the same as program 00 but sets the fader to the 0 dB position.

Channel settings are also stored in scene memories (page 164).

The channel library is controlled from the Library page shown below. Use the [VIEW] button to locate the Library page. If you are using a mouse and the CH View page is already shown, simply click the Library page title tab.

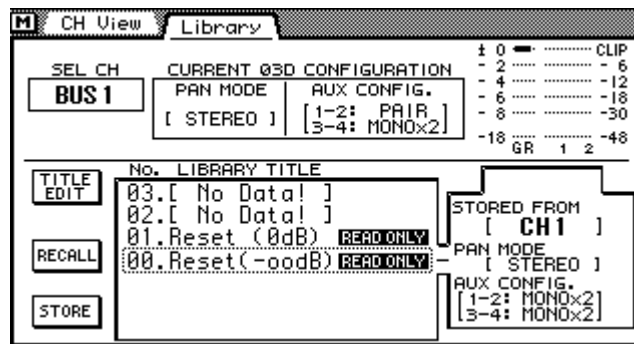

The CURRENT 03D CONFIGURATION window shows the PAN and AUX configurations. For PAN, [STEREO] indicates normal stereo pan, while [SURROUND] indicates that one of the surround pan modes is selected. For AUX, [MONOx2] indicates normal aux send mode, while [PAIR] indicated that the aux sends are configured as a stereo pair.

The meters next to the CURRENT 03D CONFIGURATION box show the signal level and gain reduction of the selected channel. Paired channels share the same dynamics parameters, so only one gain reduction meter appears.

Mix settings of the following channels can be stored in the channel library.

Input channels	CH 1–CH 24
Stereo input channel	ST IN
Aux sends	AUX 1, AUX 2, AUX 3, AUX 4
Bus outs	BUS 1, BUS 2, BUS 3, BUS 4
Stereo out	ST OUT
Effects returns	EFFECT 1, EFFECT 2

Storing Channel Programs

Channel programs are stored on the Channel Library page. You can store channel settings to user programs 02 to 50. Programs 00 and 01 are read only.

1. Use the [VIEW] button to locate the Library page.

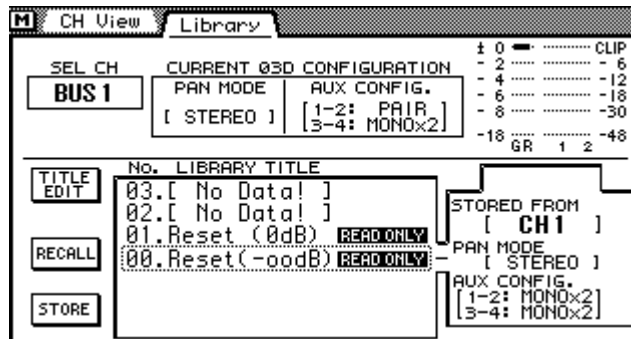

2. Use the PARAMETER wheel to scroll through the list of channel programs. If you are using a mouse, position the mouse cursor over the parameter box, press and hold the left mouse button, and then drag the mouse. As each program is selected, details of the channel data stored are displayed in the adjacent window. Channel programs that do not contain data have the title No Data!
3. Use the cursor button to select the STORE switch, and then press the [ENTER] button. If you are using a mouse, simply click the STORE switch. The Title Edit dialog box appears.
4. Enter a title for the channel program. See Title Edit Dialog Box on page 33 for more information.
5. Press OK on the Title Edit dialog box. The channel program is stored.

Recalling Channel Programs

Channel programs are recalled from the Channel Library page.

1. Use the [VIEW] button to locate the Library page.

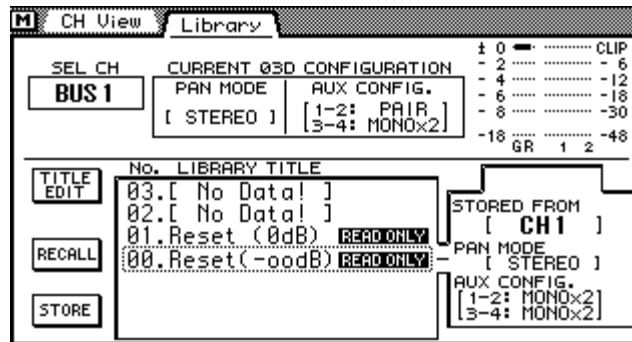

2. Use the PARAMETER wheel to scroll through the list of channel programs. If you are using a mouse, position the mouse cursor over the parameter box, press and hold the left mouse button, and then drag the mouse. Channel programs that do not contain data have the title No Data! As each program is selected, details of the channel data stored are displayed in the adjacent window.



STORED FROM—This shows which channel’s data is stored in the program.

PAN MODE—This shows the pan mode of the channel program.

AUX CONFIG—This shows the aux send configuration of the channel program.



If the selected channel program’s data conflicts with the currently selected channel, for example, STORED FROM shows an input channel but the currently selected channel is BUS 1, CONFLICT appears and a warning triangle appears next to the conflicting data.

There are four types of channel data.

Type	Data
Type 1	Input channels 1 to 24, stereo input channel, effects returns channels
Type 2	Aux send channels
Type 3	Bus out channels
Type 4	Stereo out channel

Channel programs of the same type as the currently selected channel can be recalled. For example, a channel program containing input channel 1 data can be recalled to the stereo input channel. But a channel program containing aux send 1 data cannot be recalled to a bus out.

When a mono channel program is recalled to a stereo channel (i.e., stereo input channel, an effects return channel, or input channels configured as a stereo pair), the left and right pan controls of the stereo channel are set the same as the mono input channel’s pan. When a stereo channel program is recalled to a single odd-numbered channel, that channel is set the same as the program’s left channel pan. In the case of an even-numbered channel, pan is set the same as the program’s right channel pan.

3. Use the cursor button to select the RECALL switch, and then press the [ENTER] button.

If you are using a mouse, simply click the RECALL switch.

The channel program is recalled.

Editing Channel Program Titles

Channel program titles can be edited at anytime. You don't have to recall a program to edit its title. Only channel programs that contain data can have their titles edited. Title editing is performed on the Channel Library page shown below.

1. Use the [VIEW] button to locate the Library page.

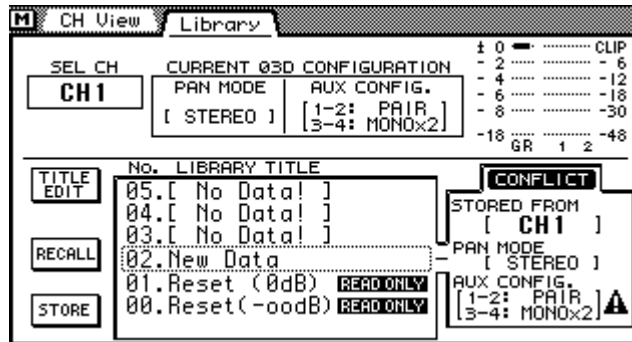

2. Select the channel program using the PARAMETER wheel or mouse.
3. Use the cursor buttons to select the TITLE EDIT switch, and then press the [ENTER] button.
If you are using a mouse, simply click the TITLE EDIT switch.
The Title Edit dialog box appears.
4. Edit the program title.
See Title Edit Dialog Box on page 33 for more information.
5. When you've finished, press OK on the Title Edit dialog box.

Channel View

The Channel View page shows various settings and parameter values of the selected input channel, stereo input channel, effects return channel, aux send, bus out, or the stereo output, allowing you to check a channel's mix settings at a glance. Parameters can also be adjusted.

1. Use the [VIEW] button to locate the CH View page.
2. Use the [SEL] and [MIXING LAYER] buttons to select a channel. See Mixing Layer on page 31 for more information.
3. Use the cursor buttons to select parameters and the [ENTER] button and PARAMETER wheel to set them.

If you are using a mouse, simply click the switches and drag the rotary controls and faders.

View pages for the different channels are shown below.

Input channel view

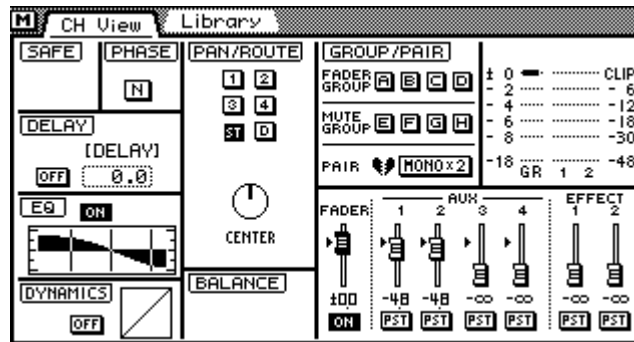

Input channel view with channels configured as a stereo pair

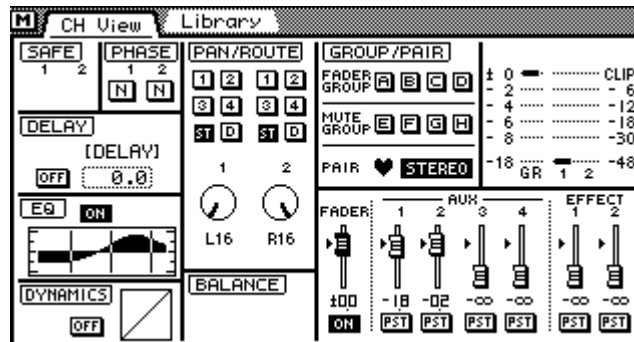

Input channel view with aux sends 1 and 2 configured as a stereo pair

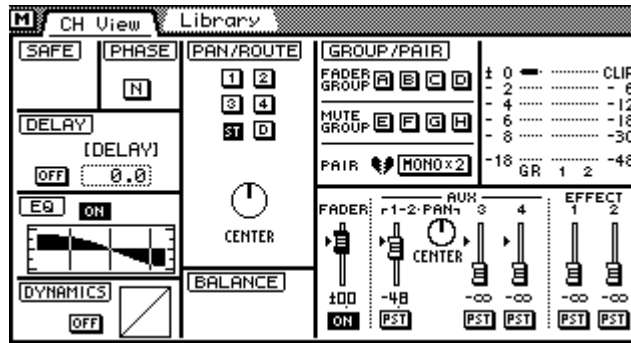

Input channel view with the 2+2 surround pan mode selected

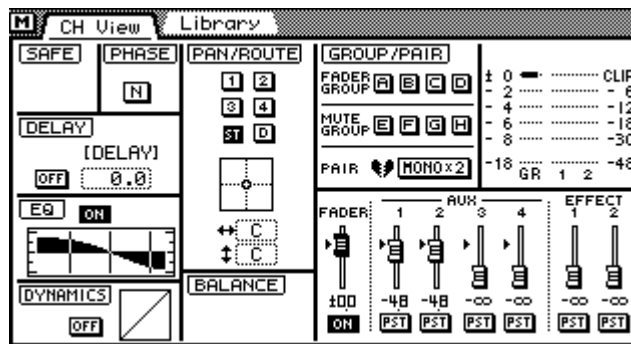

Stereo input channel view page

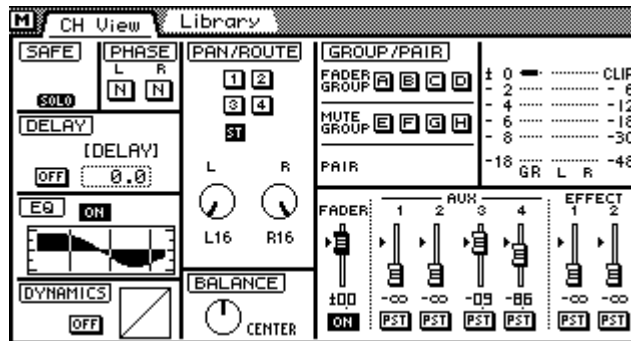

Effects return channel view page

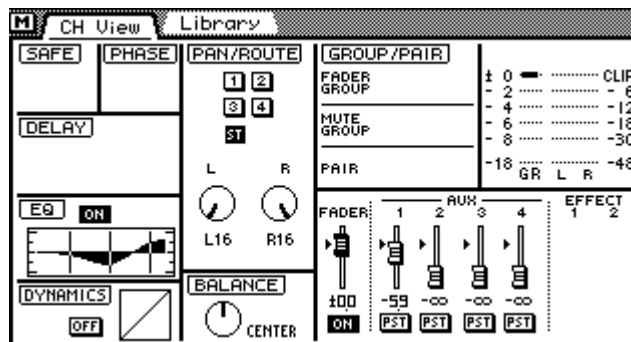

Aux send view page

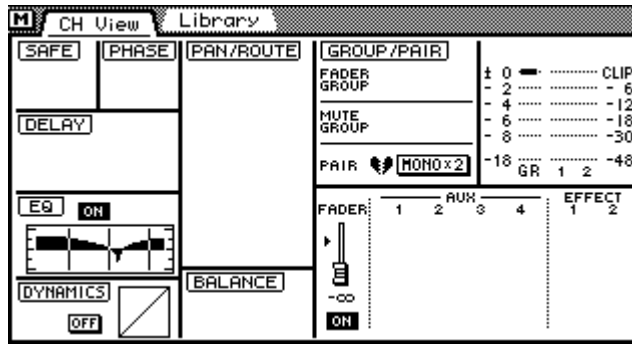

Bus out view page

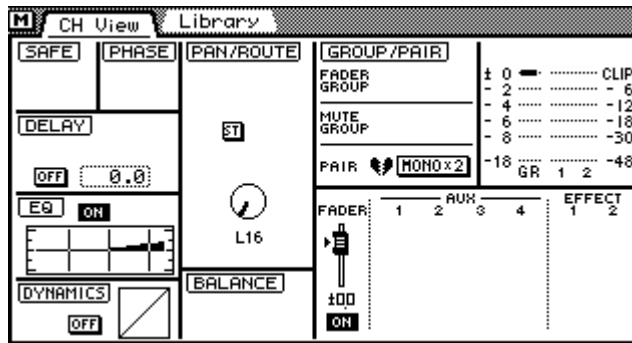

Stereo output view page

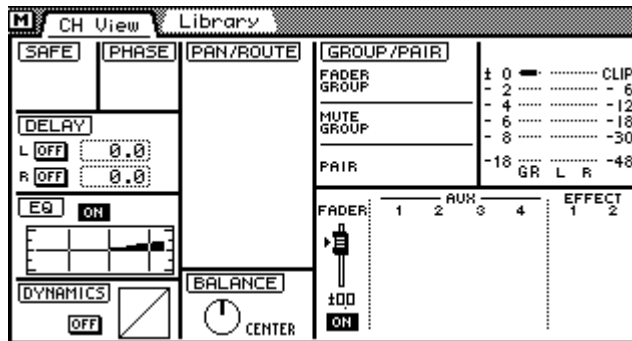

Groups & Pairs

12

In this chapter...

Fader Groups	112
Mute Groups	113
Stereo Pairs	114



Fader Groups

Faders can be grouped for multiple fader control using only one fader. This makes it easy to control several faders simultaneously. Faders for input channels 1 through 24 and the stereo input can be used in fader groups. There are four fader groups available: A, B, C, and D. Fader groups are configured on the Group page.

Making a Fader Group

1. Use the [GROUP/PAIR] button to locate the Group page shown below.

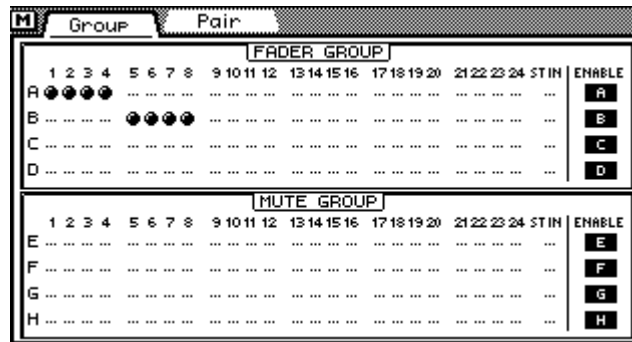

2. Use the [▲] [▼] cursor buttons to select the fader groups and the [SEL] buttons to add and remove faders to and from the fader groups. Set the Mixing Layer to 17–24/MASTER to set faders for input channels 17 to 24. If you are using a mouse, simply click to add and remove faders to and from the fader groups. Faders cannot be added to more than one fader group.

The channels of a stereo pair (*Stereo Pairs* on page 114) are added to and removed from fader groups together.

When the Group page is selected, the [SEL] buttons are used to add and remove faders to and from the fader groups. When another page is selected, the [SEL] buttons return to normal operation.

Operate only one fader in a group at a time. If you try to adjust two faders in the same group at the same time, the fader motors may malfunction due to the increased load.

Channels in a fader group can be monitored together using FADER GROUP AFL. See Setting Up Solo on page 75 for more information.

Disabling a Fader Group

The four fader groups can be disabled individually using the ENABLE switches at the right side of the Group page. This allows you to adjust individual faders within a group.

1. Use the [▲] [▼] cursor buttons to select the fader group that you want to disable: A, B, C, or D.
2. Press the [ENTER] button.
If you are using a mouse, simply click the ENABLE switch.
3. Press the [ENTER] button again to enable the fader group.

- Fader group enabled
- Fader group disabled

Mute Groups

Channels can be grouped for multiple mute control using only one [ON] button. This makes it easy to mute several channels simultaneously. Input channels 1 through 24 and the stereo input can be used in mute groups. All channels in a mute group don't have to be on or off. A mute group can contain a mix of on channels and off channels. When a mixed mute group is switched, on channels go off and off channels come on. This could, for example, be used to toggle two channels for A/B comparison. There are four mute groups available: E, F, G, and H. Mute groups are configured on the Group page.

Making a Mute Group

1. Use the [GROUP/PAIR] button to locate the Group page shown below.

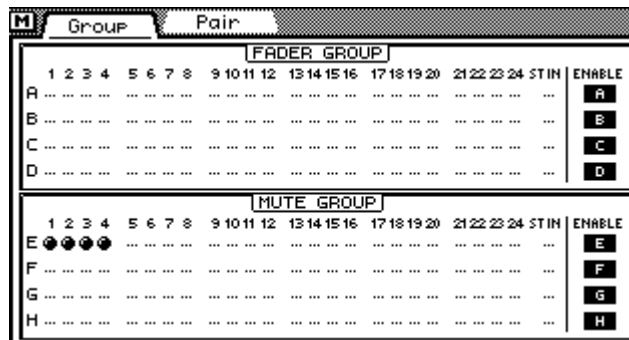

2. Use the [▲] [▼] cursor buttons to select the fader groups and the [SEL] buttons to add and remove channels to and from the mute groups. Set the Mixing Layer to 17–24/MASTER to set input channels 17 to 24.

If you are using a mouse, simply click to add and remove channels to and from the mute groups. Channels cannot be added to more than one mute group.

The channels of a stereo pair (*Stereo Pairs* on page 114) are added to and removed from mute groups together.

When the Group page is selected, the [SEL] buttons are used to add and remove channels to and from the mute groups. When another page is selected, the [SEL] buttons return to normal operation.

Disabling a Mute Group

The four mute groups can be disabled individually using the ENABLE switches at the right side of the Group page. This allows you to set individual channels within a group.

1. Use the [▲] [▼] cursor buttons to select the mute group that you want to disable: E, F, G, or H.
2. Press the [ENTER] button.
If you are using a mouse, simply click the ENABLE switch.
3. Press the [ENTER] button again to enable the mute group.

E Mute group enabled

E Mute group disabled

Stereo Pairs

Input channels, aux sends, and bus outs can be paired together for stereo operation. Paired input channels are useful for processing stereo inputs signals. Paired aux sends and bus outputs provide additional stereo outputs.

Configuring Stereo Pairs

1. Use the [GROUP/PAIR] button to locate the Pair page shown below.

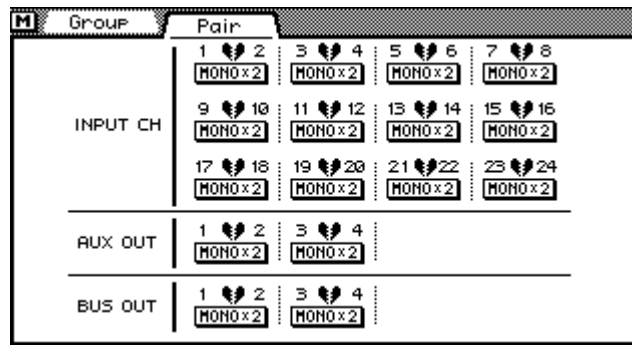

2. Use the cursor buttons to select a pair switch, and then press the [ENTER] button.

If you are using a mouse, simply click the pair switch.

Channels can also be paired using the [SEL] buttons. Simply press the two [SEL] buttons corresponding to the channels that you want to pair. Use the 17–24/MASTER Mixing Layer to access the [SEL] buttons for the input channels 17 to 24, the aux sends, and the bus out. To break a pair, press the two [SEL] buttons again.

1 2
MONO x2 Unpaired channels

1 2
STEREO Paired channels

If you are pairing input channels, the following dialog box appears.

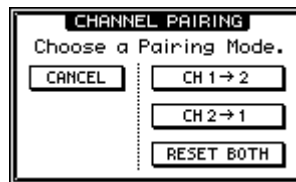

3. Use the cursor buttons to select an option, and then press the [ENTER] button.

CH 1 → 2 Make the even numbered channel settings the same as the odd channel settings and activate the channel pair.

CH 2 → 1 Make the odd numbered channel settings the same as the even channel settings and activate the channel pair.

RESET BOTH Reset both the odd and even numbered channels to their initial settings and activate the channel pair.

CANCEL Cancel the pair operation.

When you break a stereo pair, the following dialog box appears.



4. Use the cursor buttons to select either **CANCEL** or **OK**, and then press the **[ENTER]** button.

Input Channel Stereo Pairs

See Input Channel Stereo Pairs on page 43 for more information.

Aux Send Stereo Pairs

See Aux Send Stereo Pairs on page 94 for more information.

Bus Out Stereo Pairs

See Bus Out Stereo Pairs on page 101 for more information.

Onboard Effects

13

In this chapter...

About the Onboard Effects	118
Preset Effects Programs	118
Applying Effects	122
Pre-fader/Post-fader Effects Sends	123
Effects Returns	123
Effects Library	125
Storing Effects Programs	126
Recalling Effects Programs	127
Editing Effects Program Titles	128
Effects Parameters	129
Effects Block Diagram	142

About the Onboard Effects

The 03D features two onboard stereo multi-effects processors: Effect 1 and Effect 2. They provide a wide range of quality effects, including reverb, delay, chorus, flange, amp simulator, and more. There are 34 different effects type available. See Effects Parameters on page 129 for more information. The effects processors are fed by Effect 1 bus and Effect 2 bus, and the processed signals are returned via effect return 1 and effect return 2. Effects can be applied to input channels and the stereo input channel.

Effects settings can be stored as programs in the effects library. The effects library contains 64 preset programs and 32 user programs. See Effects Library on page 125 for more information. Effects settings are also stored in scene memories (page 164).

Effects processors are edited on the Eff. Edit page shown below. Use the [EFFECT 1] button to locate the Eff. Edit page for Effect 1 or the [EFFECT 2] button to locate the Eff. Edit page for Effect 2.

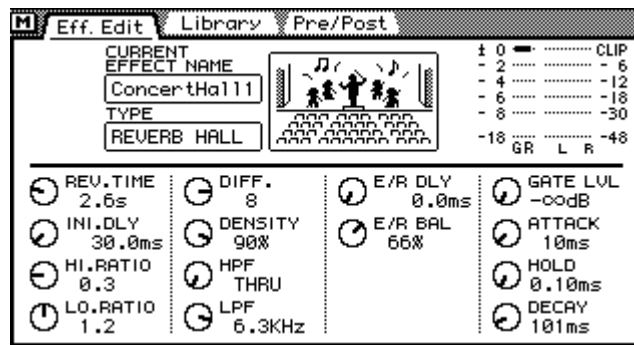

The top half of the Eff. Edit page shows the type of effect currently selected and level meters for the selected effect return. The bottom half contains the effects parameters. The number and type of parameters available depends on the type of effects processor selected.

Preset Effects Programs

The following table lists the preset effects programs. See *Effects Parameters* on page 129 for detailed parameter information. Effects programs that use the HQ, PITCH or FREEZE effect types can be used only with Effect 2.

Reverb/Early Reflections

#	Title	Type	Description
01	ConcertHall1	REVERB HALL	Simulation of a standard hall reverb
02	ConcertHall2	REVERB HALL	Variation of a long hall reverb with emphasized pre-delay
03	Bright Room	REVERB ROOM	Standard room simulation with emphasis on high frequencies
04	Dark Room	REVERB ROOM	Standard room simulation with emphasis on low frequencies
05	Live Room 1	REVERB STAGE	Bold effect simulating a concrete room
06	Live Room 2	REVERB STAGE	Reverb with long decay, milder than Live Room 1
07	Ambience 1	REVERB HALL	Ambiance-type reverb simulating a small space like a rehearsal studio
08	Ambience 2	DELAY->ER.	A brighter effect with more reflections than Ambience 1

#	Title	Type	Description
09	Rev Vocal 1	REVERB HALL	Long reverb suitable for ballad-type music
10	Rev Vocal 2	REVERB STAGE	Broadly useful reverb, good for vocals, chorus, etc
11	Rev. Plate	REVERB PLATE	Simulation of a plate echo unit
12	Reverb Stage	REVERB STAGE	Simulation of the acoustics of a stage, brighter than Hall
13	Snare Room	REVERB ROOM	Room-type reverb mainly for snare. Also effective when applied appropriately to the entire kit
14	Snare Plate	REVERB PLATE	Plate-type reverb mainly for snare, with a slightly old-fashioned feeling
15	Compact Room	DELAY+ER.	A nice feeling of presence is produced by adding a little of this to mainly to percussion instrument sounds
16	Off Mic	DELAY->ER.	Simulation of the off-mic recording technique used to record acoustic drums and percussion
17	Graceverb 1	REV->SYMPHO.	Hall-type reverb with a little modulation added
18	Graceverb 2	REV+SYMPHO.	Variation of Graceverb1
19	Slip Verb	DELAY+REV	Nonlinear reverb intended as a reverse-gate effect
20	Swept-Rev	REV->FLANGE	Reverb with a flanging effect mixed in
21	Gated Hall	REVERB HALL	A larger space than Room-type effects. Adjusting the Rev.Time and GateLvl is effective
22	Gated Room	REVERB ROOM	Room-type gated reverb. Adjusting the Rev.Time and GateLvl is likewise effective
23	Random ER	EARLY REF.	EarlyRef. producing an effect of rough reflections
24	Splatter ER	EARLY REF.	EarlyRef. producing a splashy effect
25	Reverse Gate	REVERSE GATE	Standard reverse gate setting
26	Rough Gate	GATE REVERB	Standard gated reverb setting

Delay/Echo

#	Title	Type	Description
27	DELAY L-C-R1	DELAY LCR	Standard Delay L-C-R setting. Sound will be heard in the order of left, right, and center
28	DELAY L-C-R2	DELAY LCR	Variation of Delay L-C-R. Feedback is added to Delay L-C-R1
29	PingPongEcho	ECHO	Slightly avant-guard pingpong echo; not the usual pingpong delay
30	Stereo Echo	ECHO	Standard stereo echo setting
31	8 note Delay	ECHO	Cross delay at eighth note timing

Modulation

#	Title	Type	Description
32	Chorus 1	CHORUS	Standard chorus effect setting
33	Chorus 2	CHORUS	Variation of the chorus effect
34	BrightChorus	CHORUS	Somewhat bolder variation of the chorus effect
35	FLANGE 1	FLANGE	Standard flanging effect setting
36	FLANGE 2	FLANGE	Variation of the flanging effect
37	Delange	FLANGE	Variation of the flanging effect emphasizing the delay

#	Title	Type	Description
38	Symphonic	SYMPHONIC	Standard symphonic effect setting
39	Phaser	PHASER	Simulation of a standard phaser
40	16stagePhase	PHASER	Variation of a phaser. This uses all 16 stages of phase shift
41	Auto Pan	AUTO PAN	Standard auto-pan
42	Tremolo	TREMOLO	Standard tremolo effect settings

Pitch Change

#	Title	Type	Description
43	Mono Pitch	HQ. PITCH	Long delay with slightly shifted pitch. Effective on vocal or solo instruments
44	Harmo 8va	DUAL PITCH	Sound one octave higher is returned
45	Dub Vocal	DUAL PITCH	Light harmonize effect produced by setting the delay slightly longer
46	Pitch Chorus	DUAL PITCH	An effect using pitch shift to broaden the sound. Unlike modulation effects such as chorus, this effect features no pitch modulation
47	Funny Pitch	DUAL PITCH	An effect in which a pitch shifter is fed back to successively drop the pitch

Multi-effect

#	Title	Type	Description
48	Sizzle-Rev	REV+CHORUS	An effect which adds chorus to reverb, with a bit of emphasis on the high range
49	Echora-verb	REV->CHORUS	An effect which adds chorus to repeat delay
50	Clinging-Rev	REV+FLANGE	Long reverb with flanging effect added to produce an impression of “clinging” modulation
51	Dly-Rev Long	DELAY->REV	Combination of stereo long delay and reverb
52	Vox Deverb	MONODLY->REV	Combination of mono delay and reverb, convenient as a monitor effect for vocals etc
53	Panned Verb	REV->PAN	An effect in which reverberation is panned to left and right

Distortion

#	Title	Type	Description
54	Guit. Fixer	AMP SIMULATE	This effect makes anything sound like distorted guitar
55	Drive Guitar	AMP SIMULATE	Amp simulation variation which assumes that an electric guitar is being input via direct line
56	Distortion	AMP SIMULATE	Distortion template which assumes that an electric guitar is being input via direct line
57	Overdrive	AMP SIMULATE	Overdrive variation which assumes that an electric guitar is being input via direct line

Dynamic Effects

#	Title	Type	Description
58	Auto Wah	DYNA. FILTER	Filter that uses the input level to control the frequency. This one is the standard auto-wah effect in which the filter is a BPF type
59	Flange Wah	DYNA. FLANGE	A type of flanger effect in which the input level controls the resonance point. An auto-wah effect can also be produced
60	Ethnic E	DYNA. FLANGE	A sitar-type ethnic effect, with the feedback tone concentrated in the E3 region
61	FilterPhase1	DYNA. FILTER	Dynamic filter variation which uses a LFO to produce a phaser-like effect
62	FilterPhase2	DYNA. FILTER	Variation with slightly stronger resonance than Filter-Phase 1
63	Sweep Phaser	DYNA. PHASER	A type of phaser in which the input controls the phase shift point. Effective when used on percussion instruments

Freeze

#	Title	Type	Description
64	Freeze	FREEZE	This can sample 2972.1 ms of data at a sampling rate of 44.1 kHz, 2730.6 ms at 48 kHz, or 4095.9 ms at 32 kHz

Applying Effects

1. Press the [EFFECT 1] or [EFFECT 2] button to select an effects processor.
2. Use the [SEL] and [MIXING LAYER] buttons to select a channel.
3. **Raise that channel's fader to the 0 position.**
Having pressed the EFFECT 1 or EFFECT 2 button in step 1, the channel faders are working as effects send faders.
The left and right signals of the stereo input channel are summed into a mono signal before being sent to the Aux Send buses.
4. **Raise the EFFECT RETURN fader to the 0 position.**
If you are using Effect 1, EFFECT RETURN 1 is automatically selected. Likewise, if you are using Effect 2, EFFECT RETURN 2 is automatically selected.
5. **Use the [EFFECT 1] or [EFFECT 2] button to locate the Effects Library page and recall an effects program that uses the type of effect required. See [Recalling Effects Programs on page 127](#) for more information.**
Effects programs are recalled to the currently selected effects processor. To recall an effects program to Effect 1, use the [EFFECT 1] button to locate the Library page. To recall an effects program to Effect 2, use the [EFFECT 2] button.
6. **Use the [EFFECT 1] button to locate the Eff. Edit page for Effect 1 or the [EFFECT 2] button to locate the Eff. Edit page for Effect 2.**

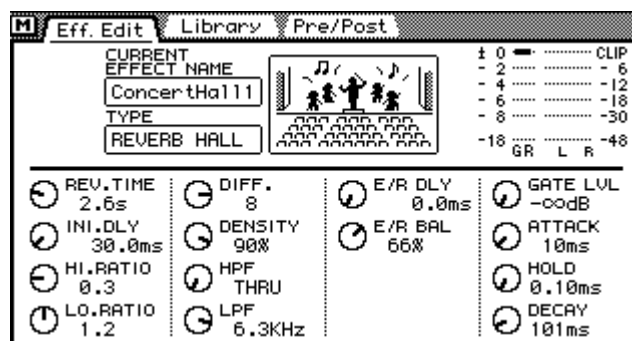

7. Use the cursor buttons to select the parameters, and the PARAMETER wheel or mouse to adjust them.
8. Use the Pre/Post page to configure aux sends as either pre-fader or post-fader sends. See [Pre-fader/Post-fader Effects Sends on page 123](#) for more information.
9. Use the effects library to store the effects settings for future use. See [Effects Library on page 125](#) for more information.
10. Set the EQ, pan, dynamics processors, and so on for the effect return channel. See [Effects Returns on page 123](#) for more information.

Pre-fader/Post-fader Effects Sends

Individual input channels and the stereo input channel effects sends can be configured as either pre-fader or post-fader sends. These settings are made on the Effects Pre/Post pages.

1. Use the [EFFECT 1] button to locate the Pre/Post page for Effect 1 or the [EFFECT 2] button to locate the Pre/Post page for Effect 2.

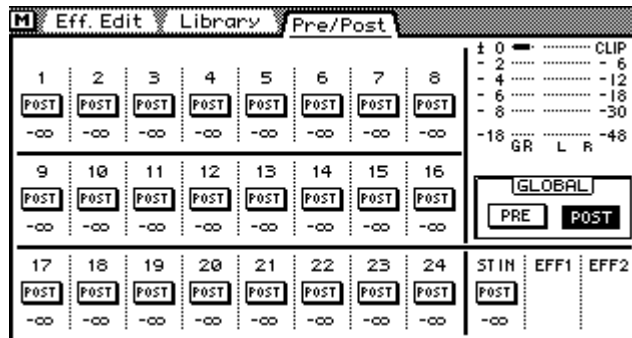

The values below the PRE/POST switches indicate the effects send fader positions.

2. Use the cursor buttons to select the PRE/POST switches and the [ENTER] button to set them.
If you are using a mouse, simply click the PRE/POST switches.
3. To set all PRE/POST switches to either pre or post, select the GLOBAL PRE or POST switch and press the [ENTER] button.
If you are using a mouse, simply click the GLOBAL switches.

Effects Returns

Effect 1 and Effect 2 are stereo effects processors, so their output signals are stereo. The following sections explain the various functions of the effects return channels.

Metering Effects Returns

Effects return signal levels can be viewed on the Eff. Edit page shown below or the Meter pages. See Metering on page 79 for more information. Send levels can be viewed on the Effects Library page.

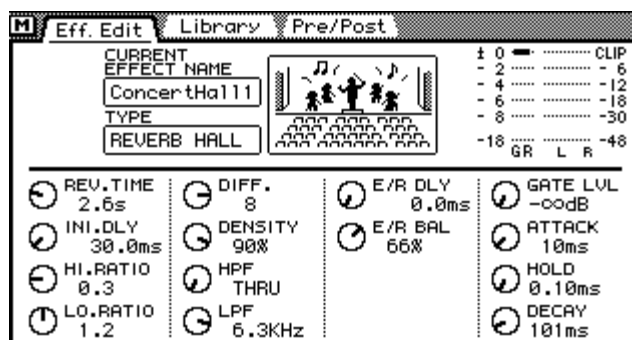

Applying EQ to Effects Returns

Each effects return features four-band parametric EQ. See EQ on page 45 for more information.

Effects Returns Dynamics Processors

Each effects return features a stereo dynamics processor. See Dynamics Processors on page 143 for more information.

Muting Effects Returns



Effects returns can be muted using the EFFECT RETURN [ON] button. This button contains an indicator that lights up when an effect return is on.

1. Use the EFFECT RETURN [SEL] button to select either EFFECT RETURN 1 or EFFECT RETURN 2.

The two LED indicators above the [SEL] button indicate which effect return is selected.

2. Press the [ON] button.

The selected effect return is muted. Press the [ON] button again to unmute the effect return.

The EFFECT RETURN [ON] button is not affected by the Mixing Layer setting.

When the [SOLO] function is on, the EFFECT RETURN [ON] buttons work as a solo button, not a mute button.

Setting Effects Returns Levels

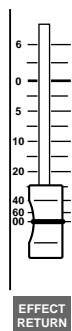

The effects return level is controlled using the EFFECT RETURN fader.

1. Use the EFFECT RETURN [SEL] button to select either EFFECT RETURN 1 or EFFECT RETURN 2.

The two LED indicators above the [SEL] button indicate which effect return is selected.

2. Use the EFFECT RETURN fader adjust the level of the selected return.

Pan, Balance & Routing

The stereo effects return signals can be routed to buses 1 to 4 and the Stereo bus. They can be balanced and panned. Pan can be used to adjust the width of the stereo effects return signals. Pan, balance, and routing settings are made on the Pan/Route page. See Stereo Pan, Balance & Routing on page 59 for more information.

Aux sends

The effects return signals can be sent to aux sends 1 to 4. Effects return signals cannot be sent to the Effects buses, as this would create a loop. See Aux Sends on page 89 for more information.

Effects Library

Effects settings can be stored as programs in the effects library. The effects library contains 64 preset programs (1–64) and 32 user programs (65–96). User programs allow you to store frequently used effects settings, and they can be titled for easy identification. The effects library can also be used to transfer settings from one effects processor to another. For example, the Effect 1 settings could be stored as a library program and then recalled to Effect 2. The unique collection of preset effects programs are designed for specific applications and instruments, and provide a good reference and starting point when using the effects processors. See page 118 for a complete list of the preset effects programs.

The effects library is controlled from the Library page shown below. Use the [EFFECT 1] or [EFFECT 2] button to locate the Library page. Although the effects library can be accessed using either button, the effects library is common to both effects. When the library is selected using the [EFFECT 1] button, store and recall operations affect Effect 1. When the library is selected using the [EFFECT 2] button, store and recall operations affect Effect 2. If you are using a mouse and the Eff. Edit page is already shown, simply click the Library page title tab.

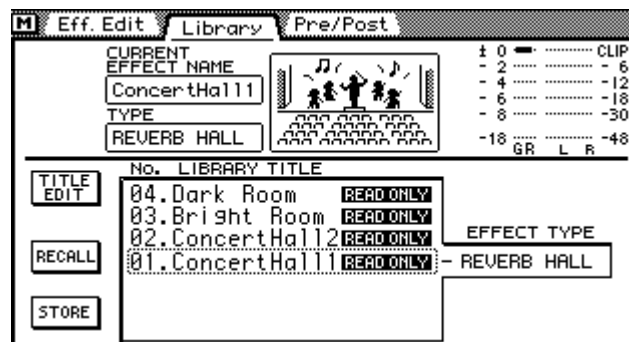

The top half of the Library page shows the type of effect currently selected and level meters for the effects send. The bottom half contains the effects library functions.

Storing Effects Programs

Effects programs are stored on the Effects Library page. You can store effects settings to user programs 65 to 96. Preset programs 1 to 64 are read only.

1. Use the [EFFECT 1] or [EFFECT 2] button to locate the Library page. Effects settings are stored from the currently selected effects processor. To store the effects settings of Effect 1, use the [EFFECT 1] button to locate the Library page. To store the effects settings of Effect 2, use the [EFFECT 2] button.

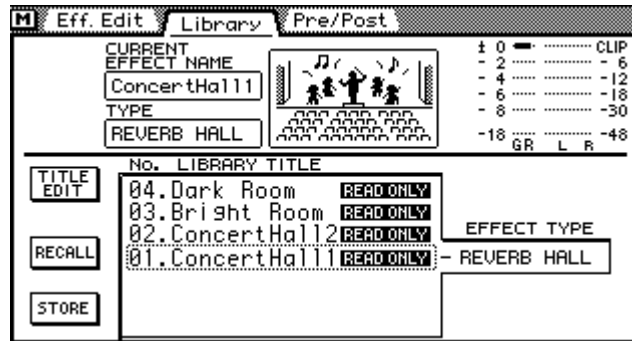

2. Use the PARAMETER wheel to scroll through the list of effects programs. If you are using a mouse, position the mouse cursor over the parameter box, press and hold the left mouse button, and then drag the mouse. As each program is selected, its type appears in the EFFECT TYPE window. Effects programs that do not contain data have the title No Data!
3. Use the cursor button to select the STORE switch, and then press the [ENTER] button. If you are using a mouse, simply click the STORE switch. The Title Edit dialog box appears.
4. Enter a title for the effects program. See Title Edit Dialog Box on page 33 for more information.
5. Press OK on the Title Edit dialog box. The effects program is stored.

Recalling Effects Programs

Effects programs are recalled from the Effects Library page. You can recall any of the 64 preset and 32 user programs. Effects programs that use the HQ, PITCH or FREEZE effect types can be recalled to only Effect 2.

1. Use the [EFFECT 1] or [EFFECT 2] button to locate the Library page.

Effects programs are recalled to the currently selected effects processor. To recall an effects program to Effect 1, use the [EFFECT 1] button to locate the Library page. To recall an effects program to Effect 2, use the [EFFECT 2] button.

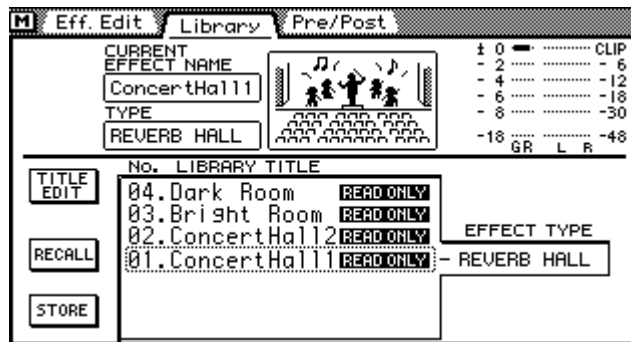

2. Use the PARAMETER wheel to scroll through the list of effects programs.

If you are using a mouse, position the mouse cursor over the parameter box, press and hold the left mouse button, and then drag the mouse.

As each program is selected, its type appears in the EFFECT TYPE window. Effects programs that do not contain data have the title No Data!

3. Use the cursor button to select the RECALL switch, and then press the [ENTER] button.

If you are using a mouse, simply click the RECALL switch.

The effects program is recalled.

Editing Effects Program Titles

Effects program titles can be edited at anytime. You don't have to recall a program to edit its title. Only effects programs that contain data can have their titles edited. Title editing is performed on the Effects Library page shown below.

1. Use the [EFFECT 1] or [EFFECT 2] button to locate the Library page.

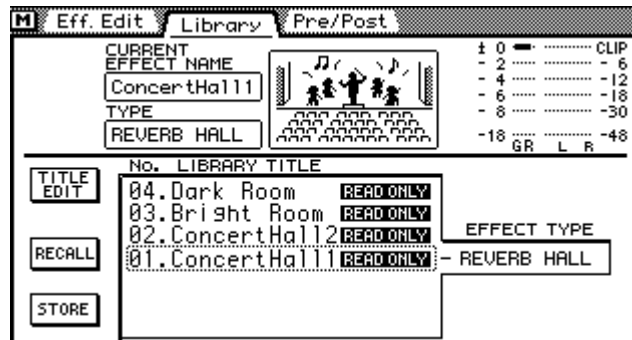

2. Select the effects program using the PARAMETER wheel or mouse.
3. Use the cursor buttons to select the TITLE EDIT switch, and then press the [ENTER] button.
If you are using a mouse, simply click the TITLE EDIT switch.
The Title Edit dialog box appears.
4. Edit the program title.
See Title Edit Dialog Box on page 33 for more information.
5. When you've finished, press OK on the Title Edit dialog box.

Effects Parameters

REVERB HALL, REVERB ROOM, REVERB STAGE, REVERB PLATE

Parameter	Range	Description
REV.TIME	0.3–99.0 s	Length of the reverb.
INI.DLY	0.1–500.0 ms	Delay time until the early reflections of the reverb are heard.
HI.RATIO	0.1–1.0	Length of the high frequency reverberation, expressed as a ratio relative to REV.TIME.
LO.RATIO	0.1–2.4	Length of the low frequency reverberation, expressed as a ratio relative to the REV.TIME.
DIFF.	0–10	Left/right spread of the reverb.
DENSITY	0–100%	Density of the reverb.
HPF	THRU, 21 Hz–8.0 kHz	Cutoff frequency of the high pass filter.
LPF	50 Hz–16.0 kHz, THRU	Cutoff frequency of the low pass filter.
E/R DLY	0.0–100.0 ms	Delay time from the early reflections (ER) until the reverb.
E/R BAL.	0–100%	Volume balance between the early reflections and the reverb. A setting of 0% is only ER, and 100% is only reverb.
GATE LVL	$-\infty$, –60 to 0 dB	Threshold level of the gate. The reverb will be cut off when the input level drops below the specified value.
ATTACK	0–120 ms	Time required for the gate to open.
HOLD	1	Time from when the input level drops below GATE LVL until the gate begins to close.
DECAY	2	Time required for the gate to close completely.

1. 0.02 ms–2.13 s @ fs=32 Khz/44.1 kHz, 0.02 ms–1.96 s @ fs=48 kHz
2. 6 ms–46.0 s @ fs=32 Khz/44.1 kHz, 5 ms–42.3 s @ fs=48 kHz

EARLY REF., REVERSE GATE, GATE REVERB

Parameter	Range	Description
TYPE	1	Type of early reflection (ER) pattern.
ROOMSIZE	0.1–20.0	Indicates the size of the room; i.e., the spacing of the reflections.
LIVENESS	0–10	Indicates how the reflections decay. 0: dead, 10: live
INI.DLY	0.1–500.0 ms	Delay time until the early reflections are heard.
DIFF.	0–10	Left/right spread of the reflections.
DENSITY	0–100%	Density of the reflections.
ER NUM.	1–16	Number of early reflections.
HI.RATIO	0.1–1.0	High frequency amount of the feedback, expressed as a ratio relative to the FB.GAIN.
FB.GAIN	–99 to +99%	Amount of feedback.
HPF	THRU, 21 Hz–8.0 kHz	Cutoff frequency of the high pass filter.
LPF	50 Hz–16.0 kHz, THRU	Cutoff frequency of the low pass filter.

1. EARLY REF. = S-Hall, L-Hall, Random, Reverse, Plate, Spring. REVERSE GATE & GATE REVERB = Type-A, Type-B

DELAY LCR

Parameter	Range	Description
DLY L	0.1–2730.0 ms	Delay time of the L channel.
DLY C	0.1–2730.0 ms	Delay time of the center delay.
DLY R	0.1–2730.0 ms	Delay time of the R channel.
LEVEL L	–100 to +100	Level of the L channel delay sound.
LEVEL C	–100 to +100	Level of the center delay sound.
LEVEL R	–100 to +100	Level of the R channel delay sound.
FB.DLY	0.1–2730.0 ms	Feedback delay time.
FB.GAIN	–99 to +99%	Amount of feedback.
HI.RATIO	0.1–1.0	High frequency amount of the feedback, expressed as a ratio relative to FB.GAIN.
HPF	THRU, 21 Hz–8.0 kHz	Cutoff frequency of the high pass filter.
LPF	50 Hz–16.0 kHz, THRU	Cutoff frequency of the low pass filter.

ECHO

Parameter	Range	Description
DLY L	0.1–1350.0 ms	Delay time of the L channel.
FB.D L	0.1–1350.0 ms	Delay time of the L channel feedback.
FB.G L	–99 to +99%	Feedback amount of the L channel.
DLY R	0.1–1350.0 ms	Delay time of the R channel.
FB.D R	0.1–1350.0 ms	Delay time of the R channel feedback.
FB.G R	–99 to +99%	Feedback amount of the R channel.
L->R FB.G	–99 to +99%	Amount of feedback from the L channel to the R channel.
R->L FB.G	–99 to +99%	Amount of feedback from the R channel to the L channel.
HI.RATIO	0.1–1.0	High frequency amount of the feedback, expressed as a ratio relative to FB.GAIN.
HPF	THRU, 21 Hz–8.0 kHz	Cutoff frequency of the high pass filter.
LPF	50 Hz–16.0 kHz, THRU	Cutoff frequency of the low pass filter.

CHORUS

Parameter	Range	Description
FREQ.	0.05–40.00 Hz	Modulation speed.
PM DEPTH	0–100%	Depth of pitch modulation.
AM DEPTH	0–100%	Depth of volume modulation.
LSF F	21 Hz–1.0 kHz	Frequency of the low shelving filter.
LSF G	–12 to +12 dB	Gain of the low shelving filter.
MOD.DLY	0.0 to 500.0 ms	Delay time from the direct sound until the modulated sound.
EQ F	99 Hz–8.0 kHz	Frequency of the parametric equalizer.
EQ G	–12 to +12 dB	Gain of the parametric equalizer.
WAVE	SINE, TRI	Modulation waveform. SINE: sine wave, TRI: triangle wave
HSF F	500 Hz–16 kHz	Frequency of the high shelving filter.
HSF G	–12 to +12 dB	Gain of the high shelving filter.

FLANGE

Parameter	Range	Description
FREQ.	0.05–40.00 Hz	Modulation speed.
DEPTH	0–100%	Modulation depth.
FB.GAIN	–99 to +99%	Feedback amount.
LSF F	21 Hz–1.0 kHz	Frequency of the low shelving filter.
LSF G	–12 to +12 dB	Gain of the low shelving filter.
MOD.DLY	0.0–500.0 ms	Delay time from the direct sound until the modulated sound.
EQ F	99 Hz–8.0 kHz	Frequency of the parametric equalizer.
EQ G	–12 to +12 dB	Gain of the parametric equalizer.
WAVE	SINE, TRI	Modulation waveform. SINE: sine wave, TRI: triangle wave
HSF F	500 Hz–16 kHz	Frequency of the high shelving filter.
HSF G	–12 to +12 dB	Gain of the high shelving filter.

SYMPHONIC

Parameter	Range	Description
FREQ.	0.05–40.00 Hz	Modulation speed.
DEPTH	0–100%	Modulation depth.
LSF F	21 Hz–1.0 kHz	Frequency of the low shelving filter.
LSF G	–12 to +12 dB	Gain of the low shelving filter.
MOD.DLY	0.0–500.0 ms	Delay time from the direct sound until the modulated sound.
EQ F	99 Hz–8.0 kHz	Frequency of the parametric equalizer.
EQ G	–12 to +12 dB	Gain of the parametric equalizer.
WAVE	SINE, TRI	Modulation waveform. SINE: sine wave, TRI: triangle wave
HSF F	500 Hz–16 kHz	Frequency of the high shelving filter.
HSF G	–12 to +12 dB	Gain of the high shelving filter.

PHASE

Parameter	Range	Description
FREQ.	0.05–40.00 Hz	Modulation speed.
DEPTH	0–100%	Modulation depth.
FB.GAIN	–99 to +99%	Feedback amount.
OFFSET	0–100	Offset of the lowest frequency to which phase shift is applied.
STAGE	2–16	Number of stages of phase shift.
LSF F	21 Hz–1.0 kHz	Frequency of the low shelving filter.
LSF G	–12 to +12 dB	Gain of the low shelving filter.
HSF F	500 Hz to 16 kHz	Frequency of the high shelving filter.
HSF G	–12 to +12 dB	Gain of the high shelving filter.

AUTOPAN

Parameter	Range	Description
FREQ.	0.05–40.00 Hz	Modulation speed.
DEPTH	0–100%	Modulation depth.
DIR.	1	Select the direction in which the sound will move.
LSF F	21 Hz–1.0 kHz	Frequency of the low shelving filter.
LSF G	–12 to +12 dB	Gain of the low shelving filter.
EQ F	99 Hz–8.0 kHz	Frequency of the parametric equalizer.
EQ G	–12 to +12 dB	Gain of the parametric equalizer.
WAVE	SINE, TRI	Modulation waveform. SINE: sine wave, TRI: triangle wave
HSF F	500 Hz–16 kHz	Frequency of the high shelving filter.
HSF G	–12 to +12 dB	Gain of the high shelving filter.

1. L<->R, L->R, L<-R, Turn L, Turn R

TREMELO

Parameter	Range	Description
FREQ.	0.05–40.00 Hz	Modulation speed.
DEPTH	0–100%	Modulation depth.
LSF F	21 Hz–1.0 kHz	Frequency of the low shelving filter.
LSF G	–12 to +12 dB	Gain of the low shelving filter.
EQ F	99 Hz–8.0 kHz	Frequency of the parametric equalizer.
EQ G	–12 to +12 dB	Gain of the parametric equalizer.
WAVE	SINE, TRI	Modulation waveform. SINE: sine wave, TRI: triangle wave
HSF F	500 Hz–16 kHz	Frequency of the high shelving filter.
HSF G	–12 to +12 dB	Gain of the high shelving filter.

HQ.PITCH (Effect 2 only)

Parameter	Range	Description
PITCH	–12 to +12	Amount of pitch change (semitones).
FINE	–50 to +50 cent	Fine adjustment (1 cent steps) to the pitch change.
DELAY	0.1–1000.0 ms	Delay time of the pitch change.
FB.GAIN	–99 to +99%	Feedback amount.
MODE	1–10	Precision of the pitch change. Higher settings will produce more accuracy, but longer delay time.

DUAL PITCH

Parameter	Range	Description
PITCH 1	-24 to +24	Amount of pitch change 1 (semitones).
FINE 1	-50 to +50 cent	Fine adjustment (1 cent steps) for pitch change 1.
PAN 1	L16-CENTER-R16	Pan for pitch change 1.
MODE	0-10	Precision of the pitch change. Higher settings will produce more accuracy, but longer delay time.
DLY 1	0.1-1000.0 ms	Delay time of pitch change 1.
FB.G 1	-99 to +99%	Feedback amount for pitch change 1.
OUT 1	-100 to +100	Level of pitch change 1.
PITCH 2	-24 to +24	Amount of pitch change 2 (semitones).
FINE 2	-50 to +50 cent	Fine adjustment (1 cent steps) for pitch change 2.
PAN 2	L16-CENTER-R16	Pan for pitch change 2.
DLY 2	0.1-1000.0 ms	Delay time of pitch change 2.
FB.G 2	-99 to +99%	Feedback amount for pitch change 2.
OUT 2	-100 to +100	Level of pitch change 2.

REV+CHORUS

Parameter	Range	Description
REV.TIME	0.3-99.0 s	Length of reverb.
INI.DLY	0.1-500.0 ms	Delay time until the early reflections of the reverb are heard.
HI.RATIO	0.1-1.0	Length of the high frequency portion of the reverb, expressed as a ratio relative to REV.TIME.
DIFF.	0-10	Left/right spread of the reverb sound.
DENSITY	0-100%	Density of the reverb.
HPF	THRU, 21 Hz-8.0 kHz	Cutoff frequency of the high pass filter.
LPF	50 Hz-16.0 kHz, THRU	Cutoff frequency of the low pass filter.
REV.BAL	0-100%	Balance of reverb and chorus. 0 is only chorus, 100 is only reverb.
FREQ.	0.05-40.00 Hz	Modulation speed.
PM DEPTH	0-100%	Pitch modulation depth.
AM DEPTH	0-100%	Volume modulation depth.
MOD.DLY	0.0-500.0 ms	Delay time from the direct sound until the modulated sound.
WAVE	SINE, TRI	Modulation waveform. SINE: sine wave, TRI: triangle wave

REV->CHORUS

Parameter	Range	Description
REV.TIME	0.3–99.0 s	Length of reverb.
INI.DLY	0.1–500.0 ms	Delay time until the early reflections of the reverb are heard.
HI.RATIO	0.1–1.0	Length of the high frequency portion of the reverb, expressed as a ratio relative to REV.TIME.
DIFF.	0–10	Left/right spread of the reverb sound.
DENSITY	0–100%	Density of the reverb.
HPF	THRU, 21 Hz–8.0 kHz	Cutoff frequency of the high pass filter.
LPF	50 Hz–16.0 kHz, THRU	Cutoff frequency of the low pass filter.
REV.BAL	0–100%	Balance of reverb and chorused reverb. 100 is only reverb.
FREQ.	0.05–40.00 Hz	Modulation speed.
PM DEPTH	0–100%	Pitch modulation depth.
AM DEPTH	0–100%	Volume modulation depth.
MOD.DLY	0.0–500.0 ms	Delay time from the direct sound until the modulated sound.
WAVE	SINE, TRI	Modulation waveform. SINE: sine wave, TRI: triangle wave

REV+FLANGE

Parameter	Range	Description
REV.TIME	0.3–99.0 s	Length of reverb.
INI.DLY	0.1–500.0 ms	Delay time until the early reflections of the reverb are heard.
HI.RATIO	0.1–1.0	Length of the high frequency portion of the reverb, expressed as a ratio relative to REV.TIME.
DIFF.	0–10	Left/right spread of the reverb sound.
DENSITY	0–100%	Density of the reverb.
HPF	THRU, 21 Hz–8.0 kHz	Cutoff frequency of the high pass filter.
LPF	50 Hz–16.0 kHz, THRU	Cutoff frequency of the low pass filter.
REV.BAL	0–100%	Balance of reverb and flanging. 0 is only flanging, 100 is only reverb.
FREQ.	0.05–40.00 Hz	Modulation speed.
DEPTH	0–100%	Modulation depth.
FB.GAIN	–99 to +99%	Amount of feedback.
MOD.DLY	0.0–500.0 ms	Delay time from the direct sound until the modulated sound.
WAVE	SINE, TRI	Modulation waveform. SINE: sine wave, TRI: triangle wave

REV->FLANGE

Parameter	Range	Description
REV.TIME	0.3–99.0 s	Length of reverb.
INI.DLY	0.1–500.0 ms	Delay time until the early reflections of the reverb are heard.
HI.RATIO	0.1–1.0	Length of the high frequency portion of the reverb, expressed as a ratio relative to REV.TIME.
DIFF.	0–10	Left/right spread of the reverb sound.
DENSITY	0–100%	Density of the reverb.
HPF	THRU, 21 Hz–8.0 kHz	Cutoff frequency of the high pass filter.
LPF	50 Hz–16.0 kHz, THRU	Cutoff frequency of the low pass filter.
REV.BAL	0–100%	Balance of reverb and flanged reverb. 100 is only reverb.
FREQ.	0.05 Hz–40.00 Hz	Modulation speed.
DEPTH	0–100%	Modulation depth.
FB.GAIN	–99 to +99%	Amount of feedback.
MOD.DLY	0.0–500.0 ms	Delay time from the direct sound until the modulated sound.
WAVE	SINE, TRI	Modulation waveform. SINE: sine wave, TRI: triangle wave

REV+SYMPHO.

Parameter	Range	Description
REV.TIME	0.3–99.0 s	Length of reverb.
INI.DLY	0.1–500.0 ms	Delay time until the early reflections of the reverb are heard.
HI.RATIO	0.1–1.0	Length of the high frequency portion of the reverb, expressed as a ratio relative to REV.TIME.
DIFF.	0–10	Left/right spread of the reverb sound.
DENSITY	0–100%	Density of the reverb.
HPF	THRU, 21 Hz–8.0 kHz	Cutoff frequency of the high pass filter.
LPF	50 Hz–16.0 kHz, THRU	Cutoff frequency of the low pass filter.
REV.BAL	0–100%	Balance of reverb and symphonic. 0 is only symphonic, 100 is only reverb.
FREQ.	0.05–40.00 Hz	Modulation speed.
DEPTH	0–100%	Modulation depth.
MOD.DLY	0.0–500.0 ms	Delay time from the direct sound until the modulated sound.
WAVE	SINE, TRI	Modulation waveform. SINE: sine wave, TRI: triangle wave

REV->SYMPHO.

Parameter	Range	Description
REV.TIME	0.3–99.0 s	Length of reverb.
INI.DLY	0.1–500.0 ms	Delay time until the early reflections of the reverb are heard.
HI.RATIO	0.1–1.0	Length of the high frequency portion of the reverb, expressed as a ratio relative to REV.TIME.
DIFF.	0–10	Left/right spread of the reverb sound.
DENSITY	0–100%	Density of the reverb.
HPF	THRU, 21 Hz–8.0 kHz	Cutoff frequency of the high pass filter.
LPF	50 Hz–16.0 kHz, THRU	Cutoff frequency of the low pass filter.
REV.BAL	0–100%	Balance of reverb and symphonic-processed reverb. 100 is only reverb.
FREQ.	0.05 Hz–40.00 Hz	Modulation speed.
DEPTH	0–100%	Modulation depth.
MOD.DLY	0.0–500.0 ms	Delay time from the direct sound until the modulated sound.
WAVE	SINE, TRI	Modulation waveform. SINE: sine wave, TRI: triangle wave

REV->PAN

Parameter	Range	Description
REV.TIME	0.3–99.0 s	Length of reverb.
INI.DLY	0.1–500.0 ms	Delay time until the early reflections of the reverb are heard.
HI.RATIO	0.1–1.0	Length of the high frequency portion of the reverb, expressed as a ratio relative to REV.TIME.
DIFF.	0–10	Left/right spread of the reverb sound.
DENSITY	0–100%	Density of the reverb.
HPF	THRU, 21 Hz–8.0 kHz	Cutoff frequency of the high pass filter.
LPF	50 Hz–16.0 kHz, THRU	Cutoff frequency of the low pass filter.
REV.BAL	0–100%	Balance of reverb and symphonic-processed reverb. 100 is only reverb.
FREQ.	0.05–40.00 Hz	Modulation speed.
DEPTH	0–100%	Modulation depth.
DIR.	1	Select the direction in which the sound will move.
WAVE	SINE, TRI	Modulation waveform. SINE: sine wave, TRI: triangle wave

1. L<->R, L->R, L<-R, Turn L, Turn R

DELAY+ER.

Parameter	Range	Description
DLY L	0.1–1000.0 ms	Delay time of the L channel.
DLY R	0.1–1000.0 ms	Delay time of the R channel.
FB.DLY	0.1–1000.0 ms	Feedback delay time.
FB.GAIN	–99 to +99%	Feedback amount.
HI.RATIO	0.1–1.0	High frequency portion of the feedback, expressed as a ratio relative to FB.GAIN.
TYPE	1	Early reflection (ER) pattern type.
ROOMSIZE	0.1–20.0	Size of the room; i.e., the spacing of the reflections.
LIVENESS	0–10	Indicates how the reflections will decay. 0: dead, 10: live
INI.DLY	0.1–500.0 ms	Delay time until the early reflections are heard.
DIFF.	0–10	Left/right spread of the reflections.
DENSITY	0–100%	Density of the reflections.
ER NUM.	1–16	Number of reflections.
ER BAL.	0–100%	Balance between ER and delay. 0 is only delay, 100 is only ER.

1. S-Hall, L-Hall, Random, Reverse, Plate, Spring

DELAY->ER.

Parameter	Range	Description
DLY L	0.1–1000.0 ms	Delay time of the L channel.
DLY R	0.1–1000.0 ms	Delay time of the R channel.
FB.DLY	0.1–1000.0 ms	Feedback delay time.
FB.GAIN	–99 to +99%	Feedback amount.
HI.RATIO	0.1–1.0	High frequency portion of the feedback, expressed as a ratio relative to FB.GAIN.
TYPE	1	Early reflection (ER) pattern type.
ROOMSIZE	0.1–20.0	Size of the room; i.e., the spacing of the reflections.
LIVENESS	0–10	Indicates how the reflections will decay. 0: dead, 10: live
INI.DLY	0.1–500.0 ms	Delay time until the early reflections are heard.
DIFF.	0–10	Left/right spread of the reflections.
DENSITY	0–100%	Density of the reflections.
ER NUM.	1–16	Number of reflections.
ER BAL.	0–100%	Balance between the delay and the early reflections delay. 0 is only delay.

1. S-Hall, L-Hall, Random, Reverse, Plate, Spring

DELAY+REV

Parameter	Range	Description
DLY L	0.1–1000.0 ms	Delay time of the L channel.
DLY R	0.1–1000.0 ms	Delay time of the R channel.
FB.DLY	0.1–1000.0 ms	Feedback delay time.
FB.GAIN	–99 to +99%	Feedback amount.
HI.RATIO	0.1–1.0	High frequency portion of the feedback, expressed as a ratio relative to FB.GAIN.
REV.TIME	0.3–99.0 s	Length of reverberation.
INI.DLY	0.1–500.0 ms	Delay time until the early reflections of the reverb are heard.
HI.RATIO	0.1–1.0	Length of reverberation for the high frequencies, expressed as a ratio relative to REV.TIME.
DIFF.	0–10	Left/right spread of the reverb.
DENSITY	0–100%	Density of the reverb.
HPF	THRU, 21 Hz–8.0 kHz	Cutoff frequency of the high pass filter.
LPF	50 Hz–16.0 kHz, THRU	Cutoff frequency of the low pass filter.
REV.BAL	0–100%	Balance of the reverb and delay. 0 is only delay, 100 is only reverb.

DELAY->REV

Parameter	Range	Description
DLY L	0.1–1000.0 ms	Delay time of the L channel.
DLY R	0.1–1000.0 ms	Delay time of the R channel.
FB.DLY	0.1–1000.0 ms	Feedback delay time.
FB.GAIN	–99 to +99%	Feedback amount.
HI.RATIO	0.1–1.0	High frequency portion of the feedback, expressed as a ratio relative to FB.GAIN.
REV.TIME	0.3–99.0 s	Length of reverberation.
INI.DLY	0.1–500.0 ms	Delay time until the early reflections of the reverb are heard.
HI.RATIO	0.1–1.0	Length of reverberation for the high frequencies, expressed as a ratio relative to REV.TIME.
DIFF.	0–10	Left/right spread of the reverb.
DENSITY	0–100%	Density of the reverb.
HPF	THRU, 21 Hz–8.0 kHz	Cutoff frequency of the high pass filter.
LPF	50 Hz–16.0 kHz, THRU	Cutoff frequency of the low pass filter.
REV.BAL	0–100%	Balance between the delay and the delayed reverb. 0 is only delay.

MONODELAY->REV

Parameter	Range	Description
DELAY	0.1–1000.0 ms	Delay time.
FB.DLY	0.1–1000.0 ms	Feedback delay time.
FB.GAIN	-99 to +99%	Feedback amount.
HI.RATIO	0.1–1.0	High frequency portion of the feedback, expressed as a ratio relative to FB.GAIN.
REV.TIME	0.3–99.0 s	Length of reverberation.
INI.DLY	0.1–500.0 ms	Delay time until the early reflections of the reverb are heard.
HI.RATIO	0.1–1.0	Length of reverberation for the high frequencies, expressed as a ratio relative to REV.TIME.
DIFF.	0–10	Left/right spread of the reverb.
DENSITY	0–100%	Density of the reverb.
HPF	THRU, 21 Hz–8.0 kHz	Cutoff frequency of the high pass filter.
LPF	50 Hz–16.0 kHz, THRU	Cutoff frequency of the low pass filter.
REV.BAL	0–100%	Balance between the delay and the delayed reverb. 0 is only delay.

AMP SIMULATE

Parameter	Range	Description
AMP TYPE	1	Select the type of amp.
DST TYPE	2	Select the type of distortion.
N.GATE	0–20	Amount of noise gating.
DRIVE	0–100	Depth of distortion.
MASTER	0–100	Master level control.
CAB DPT	0–100%	Amount of speaker simulation.
BASS	0–100	Low range tone control.
MIDDLE	0–100	Mid range tone control.
TREBLE	0–100	High range tone control.
EQ F	99 Hz–8.0 kHz	Frequency of the parametric equalizer.
EQ G	-12 to +12 dB	Gain of the parametric equalizer.
EQ Q	10.0–0.40	Bandwidth of the parametric equalizer.

1. STK-M1, STK-M2, THRASH, MIDBOOST, CMB-PG, CMB-VR, CMB-DX, CMB-TWN, MINIAMP, FLAT
2. DST1, DST2, OVD1, OVD2, CRN

DYNA.FILTER

Parameter	Range	Description
SENSE	0–100	Input sensitivity.
TYPE	LPF, HPF, BPF	Select the filter type.
OFFSET	0–100	Filter frequency offset.
RESO.	0–20	Filter resonance.
DECAY	1	Decay time of the change in filter frequency.
DIR.	Up, Down	Select whether the frequency will move upward (Up) or downward (Down) in response to a high input level.
FREQ.	0.05–40.00 Hz	LFO speed when the filter frequency is moved by the LFO.
DEPTH	0–100%	Depth at which the LFO is applied.
PHASE	0.000–354.375°	Left/right phase difference of the LFO.
LEVEL	–40 to +6 dB	Output level.

1. 6 ms–46.0 s fs=32 kHz/44.1 kHz, 5 ms–42.3 s fs=48 kHz

DYNA.FLANGE

Parameter	Range	Description
SENSE	0–100	Input sensitivity.
FB.GAIN	–99 to +99%	Feedback amount.
OFFSET	0–100	Offset amount for the delay time.
LSF F	21 Hz–1.0 kHz	Frequency of the low shelving filter.
LSF G	–12 to +12 dB	Gain of the low shelving filter.
DIR	Up, Down	Select whether the resonant frequency will move upward (Up) or downward (Down) in response to a high input level.
EQ F	99 Hz–8.0 kHz	Frequency of the parametric equalizer.
EQ G	–12 to +12 dB	Gain of the parametric equalizer.
HOLD	1	Hold time.
HSF F	500 Hz–16 kHz	Frequency of the high shelving filter.
HSF G	–12 to +12 dB	Gain of the high shelving filter.
DECAY	2	Decay time.

1. 0.02 ms–2.13 s fs=32 kHz/44.1 kHz, 0.02 ms–1.96 s fs=48 kHz
2. 6 ms–46.0 s fs=32 kHz/44.1 kHz, 5 ms–42.3 s fs=48 kHz

DYNA.PHASER

Parameter	Range	Description
SENSE	0–100	Input sensitivity.
FB.GAIN	–99 to +99%	Feedback amount.
OFFSET	0–100	Offset of the phase shift point.
HOLD	1	Hold time.
DECAY	2	Delay time.
DIR	Up, Down	Select whether the phase shift point will move upward (Up) or downward (Down) in response to a high input level.
LSF F	21 Hz–1.0 kHz	Frequency of the low shelving filter.
LSF G	–12 to +12 dB	Gain of the low shelving filter.
STAGE	2–16	Number of stages of phase shift.
HSF F	500 Hz–16 kHz	Frequency of the high shelving filter.
HSF G	–12 to +12 dB	Gain of the high shelving filter.

- 0.02 ms–2.13 s fs=32 kHz/44.1 kHz, 0.02 ms–1.96 s fs=48 kHz
- 6 ms–46.0 s fs=32 kHz/44.1 kHz, 5 ms–42.3 s fs=48 kHz

FREEZE (Effect 2 only)

Parameter	Range	Description
REC MODE	MANUAL, INP TRG	Select the recording mode. MANUAL: recording is started by the [ENTER] button. INP TRG: recording is triggered by the input signal.
REC. DLY	–1000 to +1000 ms	Specify the time difference between the trigger time and when recording actually begins. Affects recording only.
TRG. LVL	–∞, –60–0 dB	Specify the level of the input trigger.
PLY MODE	1	Select the playback mode. MOMENT: playback will occur while the [ENTER] button is pressed. CONTINUE: playback will occur the specified number of times when the [ENTER] button is pressed. INP TRG: same, but triggered by the input signal.
TRG MASK	0–999.6 ms	Specify the time from when triggering occurs until the next trigger can be accepted. Affects playback only.
MIDI TRG	OFF, C1–C6, ALL	Make settings for triggering via MIDI note-on/off messages. Only the specified note will trigger.
LOOP NUM	0–100	Specify the number of times that playback will be looped.
START	2	Specify the point at which playback will begin.
END	2	Specify the point at which playback will end. If looping is used, this will be the repeat point.
LOOP	2	Specify the start of the loop.
PITCH	–12 to +12	Specify the change in playback pitch in semitone steps.
FINE	–50 to +50 cent	Specify a fine adjustment in 1-cent steps to the playback pitch.

- MOMENT, CONTINUE, INP TRG
- 0–131070 samples (0.0–2730.6 ms fs=48 kHz, 0.0 ms–2972.1 ms fs=44.1 kHz, 0.0–4095.9 ms fs=32 kHz).

To record a sample, select the REC READY switch, and then press the [ENTER] button. The REC READY switch appears highlighted, indicating that the effect is now ready to record. If the REC MODE is set to MANUAL, press the [ENTER] button to start recording. If REC MODE is set to INP TRG, recording starts automatically when the input signal exceeds the TRG LEVEL.

To play back the sample, move the cursor to a rotary control (i.e., off the REC READY switch). If PLY MODE is set to MOMENT or CONTINUE, press the [ENTER] button to start playback. If the PLY MODE is set to INP TRG, playback starts automatically when the input signal exceeds the TRG LEVEL.

Effects Block Diagram

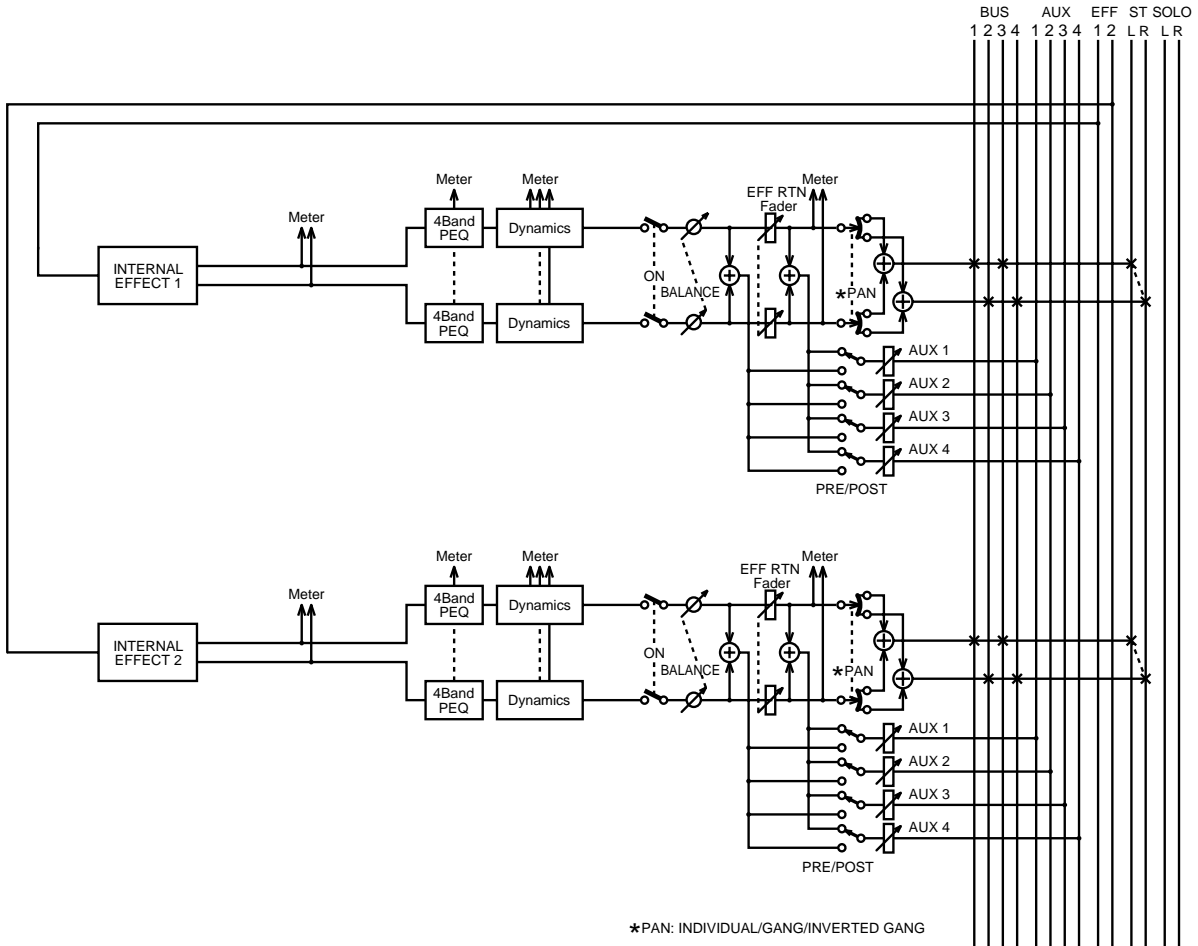

Dynamics Processors

14

In this chapter...

About the Dynamics Processors	144
Patching in a Dynamics Processor	146
Dynamics Library	147
Storing a Dynamics Program	148
Recalling a Dynamics Program	149
Editing Dynamics Program Titles	150
Processor Types	151
Preset Dynamics Programs	157

About the Dynamics Processors

Dynamics processors are available on all input channels, the stereo input channel, the stereo output, bus outputs, aux sends, and the onboard effects returns. See the *Block Diagram* on page 21 for the exact location of each dynamics processor. Dynamics processors can be configured as compressor, noise gate, ducker, expander, hard compander, or soft compander. They can be self triggering (i.e., the signal being processed is used as the trigger signal), or triggered by a signal from another channel.

When channels are configured as a stereo pair using the Pair function (*Stereo Pairs* on page 114), the dynamics processors of those two channels work together, and parameter adjustments can be made with either channel selected. You cannot set different parameters for the odd and even channels.

Dynamics settings can be stored as programs in the dynamics library. The dynamics library contains 40 preset programs and 40 user programs. See *Dynamics Library* on page 147 for more information. Dynamics settings are also stored in scene memories (page 164) and the channel library (page 104). The following table list the preset dynamics programs. See *Preset Dynamics Programs* on page 157 for detailed parameter information about the preset programs.

No.	Title	Type
01	Comp	COMP
02	Gate	GATE
03	Expand	EXPANDER
04	Ducking	DUCKING
05	Compannder(H)	COMPANDER (H)
06	Compannder(S)	COMPANDER (S)
07	A.Dr.BD	COMP
08	A.Dr.BD	GATE
09	A.Dr.BD	COMPANDER (H)
10	A.Dr.SN	COMP
11	A.Dr.SN	EXPANDER
12	A.Dr.SN	GATE
13	A.Dr.SN	COMPANDER (S)
14	A.Dr.Tom	EXPANDER
15	A.Dr.OverTop	COMPANDER (S)
16	E.B.Finger	COMP
17	E.B.Slap	COMP
18	Syn.Bass	COMP
19	Piano1	COMP
20	Piano2	COMP

No.	Title	Type
21	E.Guitar	COMP
22	A.Guitar	COMP
23	Strings1	COMP
24	Strings2	COMP
25	Strings3	COMP
26	BrassSection	COMP
27	Syn.Pad	COMP
28	SamplingPerc	COMPANDER (S)
29	Sampling BD	COMP
30	Sampling SN	COMP
31	Hip Comp	COMPANDER (S)
32	Solo Vocal1	COMP
33	Solo Vocal2	COMP
34	Chorus	COMP
35	Click Erase	EXPANDER
36	Announcer	COMPANDER (H)
37	Limiter1	COMPANDER (S)
38	Limiter2	COMP
39	Total Comp1	COMP
40	Total Comp2	COMP

Dynamics processors are edited on the Dyn. Edit page shown below. Use the [DYNAMICS] button to locate the Dyn. Edit page.

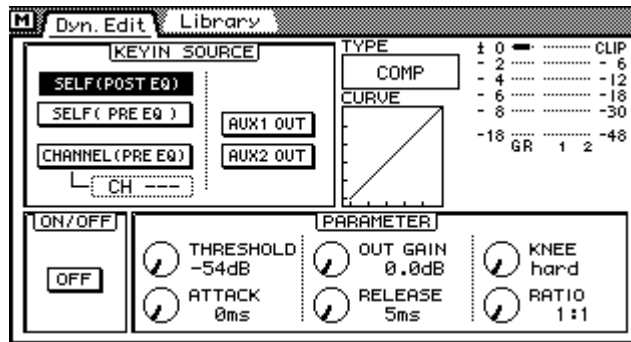

KEY IN SOURCE—These switches are used to set the KEY IN, or trigger source for the dynamics processors. The following options are available.

KEY IN	Description
SELF (POST EQ)	The dynamics processor is triggered by the signal it's processing and that signal is sourced after the EQ.
SELF (PRE EQ)	The dynamics processor is triggered by the signal it's processing and that signal is sourced before the EQ.
AUX 1 OUT	The dynamics processor is triggered by the AUX 1 send pre-EQ signal.
AUX 2 OUT	The dynamics processor is triggered by the AUX 2 send pre-EQ signal.
CHANNEL (PRE EQ)	The dynamics processor is triggered by another channel signal. Channels 1 to 24 or the left or right signal of the stereo input can be selected.

TYPE—This shows the type of dynamics processor currently selected: COMP, GATE, DUCKING, EXPAND, COMPANDER (HARD), or COMPANDER (SOFT). See Processor Types on page 151 for more information.

CURVE—This window shows the curve of the dynamics processor, providing a visual indication of how the dynamics processor is set. The horizontal axis corresponds to the input signal and the vertical axis corresponds to the output signal.

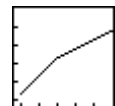

A straight line at 45 degrees from the bottom left corner indicates that the input signal will pass through the dynamics processor unaffected. This can be seen when, for example, a compressor is set with a compression ratio of 1:1.



ON/OFF—This switch is used to turn on and off the dynamics processors.

PARAMETER—These controls are used to adjust the dynamics processor's parameters. The number and type of parameters available depends on the type of dynamics processor selected.

Meters—These level meters show the level of the signal being processed and the amount of gain reduction being applied. The gain reduction meter (GR) works from top to bottom. For the COMP, DUCKING, EXPAND, and COMPANDER processors, the gain reduction meter displays the amount of gain reduction. For the GATE type, the processor is active when the input signal is below the threshold. So the gain reduction meter displays the amount of gain reduction when the input signal is below the threshold, and when there is no input signal.

Patching in a Dynamics Processor

1. Use the [SEL] and [MIXING LAYER] buttons to select a channel.
2. Use the [DYNAMICS] button to locate the Library page and recall a dynamics program that uses the type of dynamics processor required. See *Recalling a Dynamics Program* on page 149 for more information.
3. Use the [DYNAMICS] button to locate the Dyn. Edit page shown below.

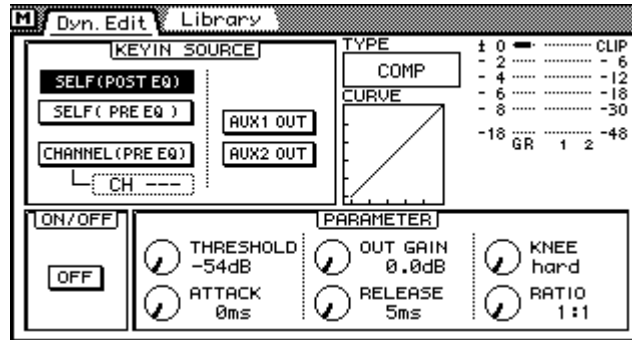

4. Use the cursor buttons to select a KEY IN SOURCE switch, and then press the [ENTER] button to activate the selection.
5. Use the cursor buttons to select the ON/OFF switch, and then press the [ENTER] button to turn on the dynamics processor.
6. Use the cursor button to select the dynamics processor parameters and the PARAMETER wheel or mouse to adjust them.

While the cursor is in the PARAMETER window, the [ENTER] button functions as dynamics processor on/off switch, allowing for quick A/B comparisons.

Dynamics Library

Dynamics settings can be stored as programs in the dynamics library. The dynamics library contains 40 preset programs (1–40) and 40 user programs (41–80). User programs allow you to store frequently used dynamics settings, and they can be titled for easy identification. The dynamics library can also be used to transfer settings from one dynamics processor to another. For example, the stereo out dynamics settings could be stored as a library program and then recalled to an aux send dynamics processor. The unique collection of preset dynamics programs are designed for specific applications and instruments, and provide a good reference and starting point when using the dynamics processors. See page 157 for a complete list of the preset dynamics programs.

The dynamics library is controlled from the Library page shown below. Use the [DYNAMICS] button to locate the Library page. If you are using a mouse and the Dyn. Edit page is already shown, simply click the Library page title tab.

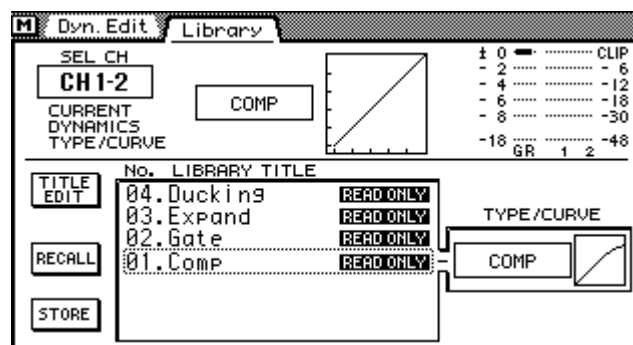

The top half of the Library page shows the dynamics TYPE/CURVE and gain reduction and level meters for the selected channel. The bottom half contains the dynamics library functions.

Storing a Dynamics Program

Dynamics programs are stored on the Dynamics Library page. You can store Dynamics settings to user programs 41 to 80. Preset programs 1 to 40 are read only.

1. Use the [DYNAMICS] button to locate the Library page.

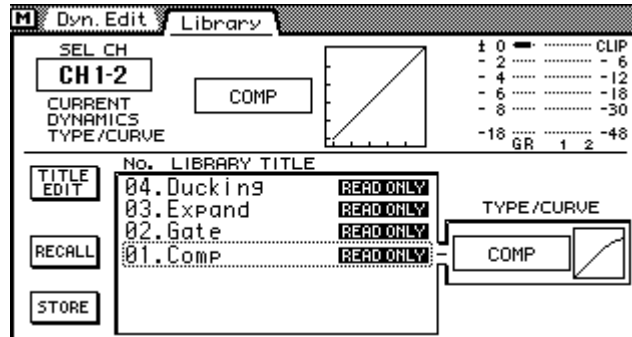

2. Use the [SEL] buttons to select the channel whose dynamics processor settings you want to store as a program.
3. Use the PARAMETER wheel to scroll through the list of dynamics programs. If you are using a mouse, position the mouse cursor over the parameter box, press and hold the left mouse button, and then drag the mouse.

As each program is selected, its type and curve appear in the TYPE/CURVE window. Dynamics programs that do not contain data have the title No Data!

4. Use the cursor button to select the STORE switch, and then press the [ENTER] button.

If you are using a mouse, simply click the STORE switch.

The Title Edit dialog box appears.

5. Enter a title for the dynamics program.

See Title Edit Dialog Box on page 33 for more information.

6. Press OK on the Title Edit dialog box.

The dynamics program is stored.

Recalling a Dynamics Program

Dynamics programs are recalled from the Dynamics Library page. You can recall any of the 40 preset and 40 user programs.

1. Use the [DYNAMICS] button to locate the Library page.

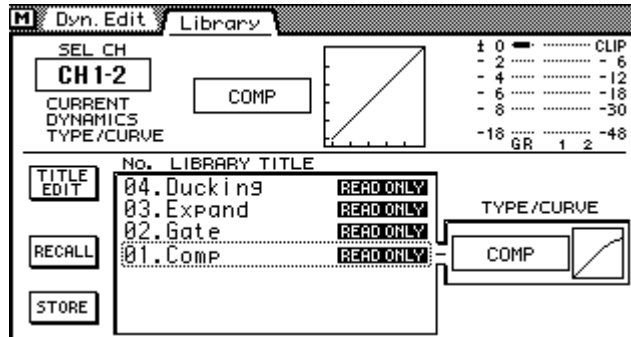

2. Use the [SEL] buttons to select the channel to which you want to recall the dynamics program.
3. Use the PARAMETER wheel to scroll through the list of Dynamics programs. If you are using a mouse, position the mouse cursor over the parameter box, press and hold the left mouse button, and then drag the mouse.

As each program is selected, its type and curve appear in the TYPE/CURVE window. Dynamics programs that do not contain data have the title No Data!

4. Use the cursor button to select the RECALL switch, and then press the [ENTER] button.

If you are using a mouse, simply click the RECALL switch.

The Dynamics program is recalled.

Editing Dynamics Program Titles

Dynamics program titles can be edited at anytime. You don't have to recall a program to edit its title. Only dynamics programs that contain data can have their titles edited. Title editing is performed on the Dynamics Library page shown below.

1. Use the [DYNAMICS] button to locate the Library page.

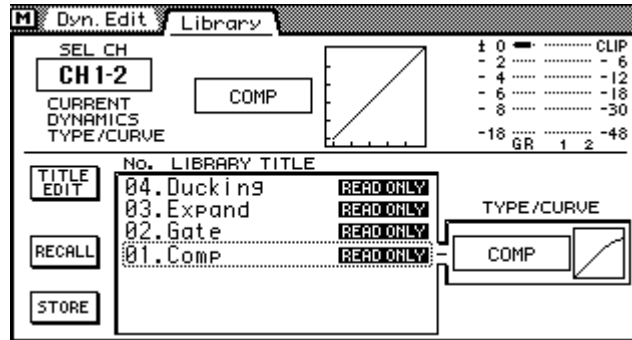

2. Select the dynamics program using the PARAMETER wheel or mouse.
3. Use the cursor buttons to select the TITLE EDIT switch, and then press the [ENTER] button.
If you are using a mouse, simply click the TITLE EDIT switch.
The Title Edit dialog box appears.
4. Edit the program title.
See Title Edit Dialog Box on page 33 for more information.
5. When you've finished, press OK on the Title Edit dialog box.

Processor Types

Dynamics processors are generally used to correct or control signal levels. They can, however, be used creatively to shape a sound's volume envelope. The dynamics processor types, parameters, and their general applications are explained in the following sections.

COMP

The COMP type dynamics processor is a compressor, providing automatic level control. A compressor attenuates signals above a specified threshold. Vocalists that tend to move toward and away from the microphone while singing produce fluctuating signal levels; sometimes loud, sometimes soft. Likewise, acoustic instruments with a large dynamic range produce sound levels from *pianissimo* (very soft) through to *fortissimo* (very loud). In these situations, it is often difficult to set an average fader level that will allow a voice or instrument to be heard clearly throughout a song or piece of music. This is where the compressor comes in with automatic level control. By automatically reducing high levels, thus effectively reducing the dynamic range, the compressor makes it much easier to control signals and set appropriate fader levels. Reducing the dynamic range also means that recording levels can be set higher, therefore improving signal-to-noise performance.

The COMP type can also be used as a limiter, which is essentially a compressor with a high ratio setting. Compression ratios above 10:1 are considered to limit signals rather than compress them. When an input signal exceeds the specified threshold level, its level is automatically reduced to the threshold level. This means that the limiter's output level never actually exceeds the threshold level. Limiters are often used to prevent signals from overloading amplifiers and tape recorders. A limiter with a relatively high threshold, for example, could be patched into the stereo outputs to prevent amplifier and speaker overload.

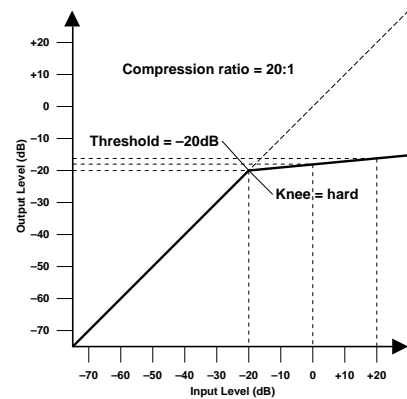
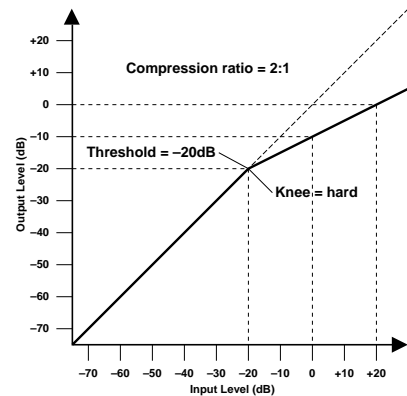

Parameter	Range
THRESHOLD	-54 dB to 0 dB (55 steps)
RATIO	1:1, 1.1:1, 1.3:1, 1.5:1, 1.7:1, 2:1, 2.5:1, 3:1, 3.5:1, 4:1, 5:1, 6:1, 8:1, 10:1, 20:1, ∞:1 (16 steps)
KNEE	hard, 1, 2, 3, 4, 5
ATTACK	0–120 ms (1 ms steps)
RELEASE	5 ms–42.3 s (sampling rate @ 48 kHz) 6 ms–46 s (sampling rate @ 44.1 kHz) 8 ms–63.4 s (sampling rate @ 32 kHz)
OUT GAIN	0.0 dB to +18.0 dB (0.5 dB steps)

THRESHOLD—This determines the level of input signal required to trigger the compressor. Signals at a level below the threshold pass through the compressor unaffected.

Signals at and above the threshold level are compressed by the amount specified using the Ratio parameter. The trigger signal is sourced using the KEY IN parameter.

RATIO—This determines the amount of compression. That is, the change in output signal level relative to change in input signal level. For a 2:1 ratio, for example, a 10 dB change in input level (above the threshold) results in a 5 dB change in output level. For a 5:1 ratio, a 10 dB change in input level (above the threshold) results in a 2 dB change in output level.

KNEE—This determines how compression is applied at the threshold point. When set to hard, compression at the specified ratio is applied as soon as the input signal level exceeds the specified threshold. For knee settings from 1 to 5, however, compression is applied gradually as the signal exceeds the specified threshold, creating a more natural sound. This is called soft-knee compression.

ATTACK—This determines how soon the signal is compressed once the compressor has been triggered. With a fast attack time, the signal is compressed almost immediately. With a slow attack time, however, the initial transient of a sound passes through unaffected. Attack times from 1–5 ms are a good place to start.

RELEASE—This determines how soon the compressor returns to its normal gain once the trigger signal level drops below the threshold. If the release time is too short, the gain will recover too quickly causing level pumping (i.e. noticeable gain fluctuations). If it is set too long, the compressor may not have time to recover before the next high level signal appears, and it will be compressed incorrectly. Release times from 0.1–0.5s are a good place to start.

OUT GAIN—This sets the compressor’s output signal level. It can be used to compensate for the overall level change caused by the compression process.

GATE

A gate, or noise gate is essentially an audio switch used to mute signals below a set threshold level. It can be used to cut background noise picked up by open microphones, noise and hiss from guitar valve amps and effects pedals, and leakage between drum microphones. It also has many creative uses too. For example, gating a drum sound with a short decay time tightens up the sound. Also, patching a gate into a droning bass synth channel and then triggering it from the kick drum channel allows the bass synth through only when the kick drum is struck, adding extra “oomph” on the beat.

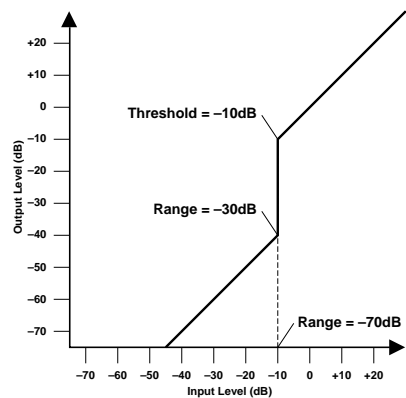

Parameter	Range
THRESHOLD	-54 dB to 0 dB (55 steps)
RANGE	-70 dB to 0 dB (71 steps)
ATTACK	0–120 ms (1 ms steps)
HOLD	0.02 ms–1.96 s (sampling rate @ 48 kHz) 0.02 ms–2.13 s (sampling rate @ 44.1 kHz) 0.03 ms–2.94 s (sampling rate @ 32 kHz)
DECAY	5 ms–42.3 s (sampling rate @ 48 kHz) 6 ms–46 s (sampling rate @ 44.1 kHz) 8 ms–63.4 s (sampling rate @ 32 kHz)

THRESHOLD—This determines the level at which the gate closes, cutting off the signal. Signals above the threshold level pass through unaffected. Signals at or below the threshold, however, cause the gate to close. The trigger signal is sourced using the KEY IN parameter.

RANGE—This determines the level to which the gate closes. Think of it as a brick holding a garden gate open so that a certain amount of signal always flows through. For a setting of -70 dB, the gate closes completely when the input signal falls below the threshold. For a setting of -30 dB, however, the gate only closes so far. For a setting of 0 dB, the gate has no effect. When signals are gated abruptly, the sudden disappearance can sometimes sound odd. This parameter causes the gate to reduce the signal level rather than cut it completely.

ATTACK—This determines how fast the gate opens when the signal exceeds the threshold level. Slow attack times can be used to remove the initial transient edge of percussive sounds. Too slow an attack time makes some sounds appear backwards.

HOLD—This determines how long the gate stays open once the trigger signal has fallen below the threshold level.

DECAY—This determines how fast the gate closes once the hold time has expired. A longer decay time produces a more natural gating effect, allowing the natural decay of an instrument to pass through. With a maximum decay time of between 42 and 63 seconds, you could even use this for fade-outs.

DUCKING

Ducking is commonly used for voice-over applications, where the background music level is reduced automatically when an announcer speaks. Ducking is achieved by triggering a compressor with a different sound source. For example, a ducker is patched into the background music channel, and the KEY IN signal is sourced from the announcer's microphone channel. When the announcer's microphone level exceeds the specified threshold, the background music level is reduced automatically, allowing the announcer to be heard clearly. The same technique can also be used for vocals in a mix. For example, ducking backing sounds such as rhythm guitar and synth pad during vocal phrases allows the vocals to be heard clearly. This can also be used to bring solo instruments up in a mix.

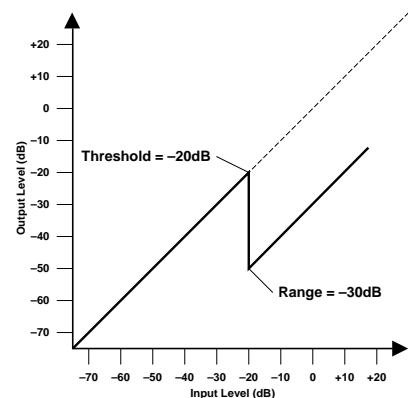

Parameter	Range
THRESHOLD	-54 dB to 0 dB (55 steps)
RANGE	-70 dB to 0 dB (71 steps)
ATTACK	0 – 120 ms (1 ms steps)
HOLD	0.02 ms– 1.96 s (sampling rate @ 48 kHz) 0.02 ms– 2.13 s (sampling rate @ 44.1 kHz) 0.03 ms– 2.94 s (sampling rate @ 32 kHz)
DECAY	5 ms– 42.3 s (sampling rate @ 48 kHz) 6 ms– 46 s (sampling rate @ 44.1 kHz) 8 ms– 63.4 s (sampling rate @ 32 kHz)

THRESHOLD—This determines the level of trigger signal (KEY IN) required to activate ducking. Trigger signal levels below the threshold do not activate ducking. Trigger signals at and above the threshold level, however, activate ducking, and the signal level

is reduced to a level set by the Range parameter. The trigger signal is sourced using the KEY IN parameter.

RANGE—This determines the level to which the signal is ducked. For a setting of -80 dB, the signal is virtually cutoff. For a setting of -30 dB, however, the signal is ducked by 30 dB. For a setting of 0 dB, the ducker has no effect.

ATTACK—This determines how soon the signal is ducked once the ducker has been triggered. With a fast attack time, the signal is ducked almost immediately. With a slow attack time, however, ducking appears to fade the signal. Too fast an attack time may sound abrupt.

HOLD— This determines how long ducking remains active once the trigger signal has fallen below the threshold level.

DECAY—This determines how soon the ducker returns to its normal gain once the trigger signal level drops below the threshold.

EXPAND

An expander is similar to a compressor except that it works on signals below the threshold level. By reducing signals below the threshold level, the expander attenuates low-level noise, effectively increasing the dynamic range and improving the signal-to-noise performance. An expander set to an infinite ratio (i.e., $\infty:1$) is essentially a gate. The following two graphs show typical expander curves. The left one shows an expander with an expansion ratio of 2:1 and a hard knee setting. The right one shows an expander with an expansion ratio of 2:1 and a soft knee setting of 5.

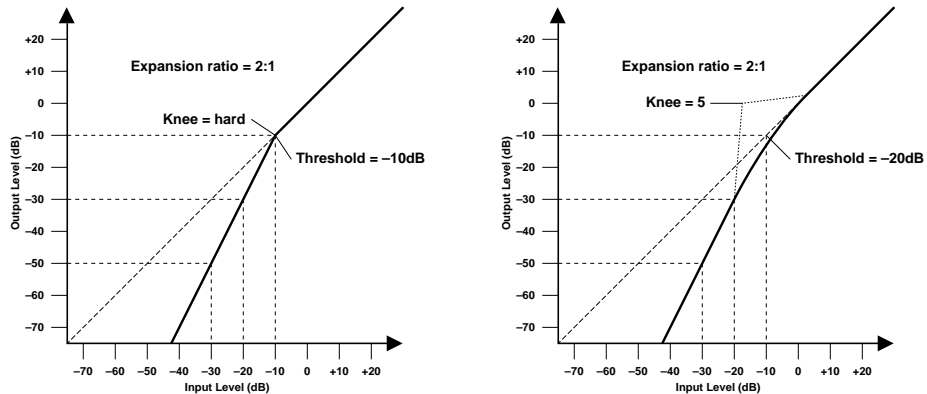

Parameter	Range
THRESHOLD	-54 dB to 0 dB (55 steps)
RATIO	1:1, 1.1:1, 1.3:1, 1.5:1, 1.7:1, 2:1, 2.5:1, 3:1, 3.5:1, 4:1, 5:1, 6:1, 8:1, 10:1, 20:1, $\infty:1$ (16 steps)
KNEE	hard, 1, 2, 3, 4, 5
ATTACK	0–120 ms (1 ms steps)
RELEASE	5 ms–42.3 s (sampling rate @ 48 kHz) 6 ms–46 s (sampling rate @ 44.1 kHz) 8 ms–63.4 s (sampling rate @ 32 kHz)
OUT GAIN	0.0 dB to +18.0 dB (0.5 dB steps)

THRESHOLD—This determines the level of input signal required to trigger the expander. Signals above the threshold pass through the expander unaffected. Signals at and below the threshold level are attenuated by the amount specified using the Ratio parameter. The trigger signal is sourced using the KEY IN parameter.

RATIO—This determines the amount of expansion. That is, the change in output signal level relative to change in input signal level. For a 2:1 ratio, for example, a 5 dB change in input level (below the threshold) results in a 10 dB change in output level. For a 5:1 ratio, a 2 dB change in input level (below the threshold) results in a 10 dB change in output level.

KNEE—This determines how expansion is applied at the threshold point. When set to hard, expansion at the specified ratio is applied as soon as the input signal level falls below the specified threshold. For knee settings from 1 to 5, however, expansion is applied gradually as the signal falls below the specified threshold, creating a more natural sound.

ATTACK—This determines how soon the signal is expanded once the expander has been triggered. With a fast attack time, the signal is expanded almost immediately. With a slow attack time, however, the initial transient of a sound passes through unaffected. Attack times from 1–5 ms are a good place to start.

RELEASE—This determines how soon the expander returns to its normal gain once the trigger signal level exceeds the threshold. If the release time is too short, the gain will recover too quickly causing level pumping (i.e. noticeable gain fluctuations). If it is set too long, the expander may not have time to recover before the next low-level signal appears, and it will be expanded incorrectly. Release times from 0.1–0.5s are a good place to start.

OUT GAIN—This sets the expander’s output signal level. It can be used to compensate for the overall level change caused by the expansion process.

COMPANDER (HARD & SOFT)

The hard and soft companders comprise of compressor, expander, and limiter. The limiter prevents output signals from exceeding 0 dB. The compressor compresses signals that exceed the threshold level. The expander attenuates signals below the threshold and width. The soft compander has an expansion ratio of 1.5:1, while the hard compander has an expansion ratio of 5:1. The following two graphs show typical compander curves. The left one shows the hard compander. The right one shows the soft compander.

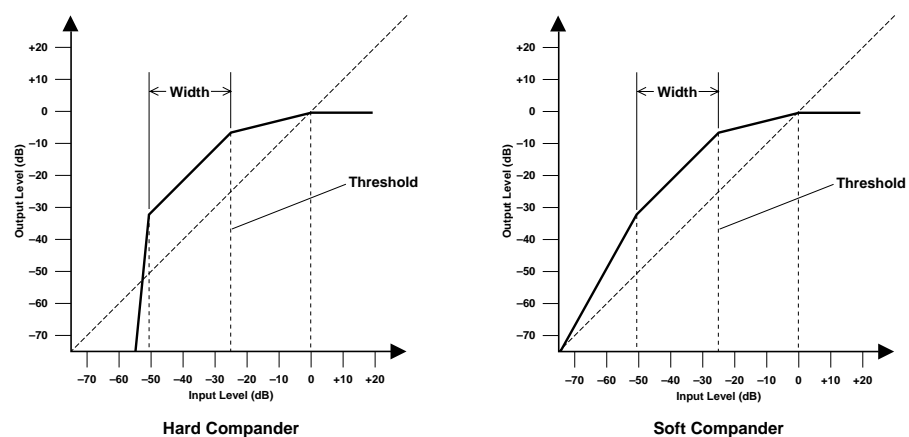

Parameter	Range
THRESHOLD	–54 dB to 0 dB (55 steps)
RATIO	1:1, 1.1:1, 1.3:1, 1.5:1, 1.7:1, 2:1, 2.5:1, 3:1, 3.5:1, 4:1, 5:1, 6:1, 8:1, 10:1, 20:1 (15 steps)
WIDTH	1 dB–90 dB (1 dB steps)

Parameter	Range
ATTACK	0–120 ms (1 ms steps)
RELEASE	5 ms–42.3 s (sampling rate @ 48 kHz) 6 ms–46 s (sampling rate @ 44.1 kHz) 8 ms–63.4 s (sampling rate @ 32 kHz)
OUT GAIN	–18 dB to 0 dB (0.5 dB steps)

THRESHOLD—This determines the input signal level at which compression and expansion are applied. Signals at a level below the threshold+width are attenuated by the expander. Signals at and above the threshold level are compressed by the amount specified using the Ratio parameter. The trigger signal is sourced using the KEY IN parameter.

RATIO—This determines the amount of compression. That is, the change in output signal level relative to change in input signal level. For a 2:1 ratio, for example, a 10 dB change in input level (above the threshold) results in a 5 dB change in output level. For a 5:1 ratio, a 10 dB change in input level (above the threshold) results in a 2 dB change in output level. The expander ratios are fixed: 1.5:1 for the soft compander and 5:1 for the hard compander.

WIDTH—This determines how far below the threshold level expansion is applied. The expander is essentially turned off when the width is set to 90 dB.

ATTACK—This determines how soon the signal is compressed and expanded once the compander has been triggered. With a fast attack time, the signal is companded almost immediately. With a slow attack time, however, the initial transient of a sound passes through unaffected. Attack times from 1–5 ms are a good place to start.

RELEASE—This determines how soon the compressor and expander return to their normal gains once the trigger signal level drops below the threshold. If the release time is too short, the gain will recover too quickly causing level pumping (i.e. noticeable gain fluctuations). If it is set too long, the compressor may not have time to recover before the next high level signal appears, and it will be compressed incorrectly. Release times from 0.1–0.5s are a good place to start.

OUT GAIN—This sets the compander's output signal level. It can be used to compensate for the overall level change caused by the compression and expansion processes.

Preset Dynamics Programs

#	Title	Type	Parameter	Value	Description
01	Comp	Compressor	Threshold (dB)	-8	Compressor intended to reduce the overall volume level. Use it on the stereo output during mix-down. It can also be used with the stereo input.
			Ratio (:1)	2.5	
			Attack (ms)	60	
			Outgain (dB)	0.0	
			Knee	2	
			Release (ms)	1.12 S	
02	Gate	Gate	Threshold (dB)	-26	Gate template.
			Range (dB)	-56	
			Attack (ms)	0	
			Hold (ms)	2.56	
			Decay (ms)	331	
03	Expand	Expander	Threshold (dB)	-23	Expander template.
			Ratio (:1)	1.7	
			Attack (ms)	1	
			Outgain (dB)	3.5	
			Knee	2	
			Release (ms)	70	
04	Ducking	Ducking	Threshold (dB)	-19	Ducking template.
			Range (dB)	-22	
			Attack (ms)	93	
			Hold (ms)	1.20 S	
			Decay (ms)	6.32 S	
05	Compander(H)	Compander (H)	Threshold (dB)	-10	Hard-knee compressor template.
			Ratio (:1)	3.5	
			Attack (ms)	1	
			Outgain (dB)	0.0	
			Width (dB)	6	
			Release (ms)	250	
06	Compander(S)	Compander (S)	Threshold (dB)	-8	Soft-knee compressor template.
			Ratio (:1)	4	
			Attack (ms)	25	
			Outgain (dB)	0.0	
			Width (dB)	24	
			Release (ms)	180	
07	A.Dr.BD	Compressor	Threshold (dB)	-24	Compressor program for use with acoustic kit's bass drum.
			Ratio (:1)	3	
			Attack (ms)	9	
			Outgain (dB)	5.5	
			Knee	2	
			Release (ms)	58	
08	A.Dr.BD	Gate	Threshold (dB)	-11	Gate program for use with acoustic kit's bass drum.
			Range (dB)	-53	
			Attack (ms)	0	
			Hold (ms)	1.93	
			Decay (ms)	400	

#	Title	Type	Parameter	Value	Description
09	A.Dr.BD	Compander (H)	Threshold (dB)	-11	Compander (H) program for use with acoustic kit's bass drum.
			Ratio (:1)	3.5	
			Attack (ms)	1	
			Outgain (dB)	-1.5	
			Width (dB)	7	
			Release (ms)	192	
10	A.Dr.SN	Compressor	Threshold (dB)	-17	Compressor program for use with acoustic kit's snare drum.
			Ratio (:1)	2.5	
			Attack (ms)	8	
			Outgain (dB)	3.5	
			Knee	2	
			Release (ms)	12	
11	A.Dr.SN	Expander	Threshold (dB)	-23	Expander program for use with acoustic kit's snare drum.
			Ratio (:1)	2	
			Attack (ms)	0	
			Outgain (dB)	0.5	
			Knee	2	
			Release (ms)	151	
12	A.Dr.SN	Gate	Threshold (dB)	-8	Gate program for use with acoustic kit's snare drum.
			Range (dB)	-23	
			Attack (ms)	1	
			Hold (ms)	0.63	
			Decay (ms)	238	
13	A.Dr.SN	Compander (S)	Threshold (dB)	-8	Compander (H) program for use with acoustic kit's snare drum.
			Ratio (:1)	1.7	
			Attack (ms)	11	
			Outgain (dB)	0.0	
			Width (dB)	10	
			Release (ms)	128	
14	A.Dr.Tom	Expander	Threshold (dB)	-20	Expander program for use with acoustic kit's tom toms, which automatically reduces the volume when the tom toms are not played, helping to differentiate the bass and snare drums clearly.
			Ratio (:1)	2	
			Attack (ms)	2	
			Outgain (dB)	5.0	
			Knee	2	
			Release (ms)	749	
15	A.Dr.OverTop	Compander (S)	Threshold (dB)	-24	Soft-knees compander program to emphasize the attack and ambience of cymbals recorded with overhead microphones. It automatically reduces the volume when the cymbals are not played, helping to differentiate the bass and snare drums clearly.
			Ratio (:1)	2	
			Attack (ms)	38	
			Outgain (dB)	-3.5	
			Width (dB)	54	
			Release (ms)	842	
16	E.B.Finger	Compressor	Threshold (dB)	-12	Compressor program to level the attack and volume level of a finger-picked electric bass guitar.
			Ratio (:1)	2	
			Attack (ms)	15	
			Outgain (dB)	4.5	
			Knee	2	
			Release (ms)	470	

#	Title	Type	Parameter	Value	Description
17	E.B.Slap	Compressor	Threshold (dB)	-12	Compressor program to level the attack and volume level of a slap electric bass guitar.
			Ratio (:1)	1.7	
			Attack (ms)	6	
			Outgain (dB)	4.0	
			Knee	hard	
			Release (ms)	133	
18	Syn.Bass	Compressor	Threshold (dB)	-10	Compressor program to control or emphasize the level of a synth bass.
			Ratio (:1)	3.5	
			Attack (ms)	9	
			Outgain (dB)	3.0	
			Knee	hard	
			Release (ms)	250	
19	Piano1	Compressor	Threshold (dB)	-9	Compressor program to brighten the tonal color of a piano.
			Ratio (:1)	2.5	
			Attack (ms)	17	
			Outgain (dB)	1.0	
			Knee	hard	
			Release (ms)	238	
20	Piano2	Compressor	Threshold (dB)	-18	A variation on program 19, using a deep threshold to change the entire attack and level.
			Ratio (:1)	3.5	
			Attack (ms)	7	
			Outgain (dB)	6.0	
			Knee	2	
			Release (ms)	174	
21	E.Guitar	Compressor	Threshold (dB)	-8	Compressor program for electric guitar cutting and arpeggio-style backing performance. The sound color can be varied using different playing styles.
			Ratio (:1)	3.5	
			Attack (ms)	7	
			Outgain (dB)	2.5	
			Knee	4	
			Release (ms)	261	
22	A.Guitar	Compressor	Threshold (dB)	-10	Compressor program for acoustic guitar stroke and arpeggio-style backing performance.
			Ratio (:1)	2.5	
			Attack (ms)	5	
			Outgain (dB)	1.5	
			Knee	2	
			Release (ms)	238	
23	Strings1	Compressor	Threshold (dB)	-11	Compressor program for strings.
			Ratio (:1)	2	
			Attack (ms)	33	
			Outgain (dB)	1.5	
			Knee	2	
			Release (ms)	749	
24	Strings2	Compressor	Threshold (dB)	-12	A variation on program 23, intended for violas or cellos.
			Ratio (:1)	1.5	
			Attack (ms)	93	
			Outgain (dB)	1.5	
			Knee	4	
			Release (ms)	1.35 S	

#	Title	Type	Parameter	Value	Description
25	Strings3	Compressor	Threshold (dB)	-17	A variation on program 23, intended for string instruments with a very low range, such as cellos or contrabass.
			Ratio (:1)	1.5	
			Attack (ms)	76	
			Outgain (dB)	2.5	
			Knee	2	
			Release (ms)	186	
26	BrassSection	Compressor	Threshold (dB)	-18	Compressor program intended for brass sounds with a fast and strong attack.
			Ratio (:1)	1.7	
			Attack (ms)	18	
			Outgain (dB)	4.0	
			Knee	1	
			Release (ms)	226	
27	Syn.Pad	Compressor	Threshold (dB)	-13	Compressor program for synth pad, intended to prevent diffusion of the sound.
			Ratio (:1)	2	
			Attack (ms)	58	
			Outgain (dB)	2.0	
			Knee	1	
			Release (ms)	238	
28	SamplingPerc	Compander (S)	Threshold (dB)	-18	Compressor program for sampled sounds, making them as powerful as real acoustic drums. This program is for percussion sounds.
			Ratio (:1)	1.7	
			Attack (ms)	8	
			Outgain (dB)	-2.5	
			Width (dB)	18	
			Release (ms)	238	
29	Sampling BD	Compressor	Threshold (dB)	-14	A variation on program 28, intended for sampled bass drum sounds.
			Ratio (:1)	2	
			Attack (ms)	2	
			Outgain (dB)	3.5	
			Knee	4	
			Release (ms)	35	
30	Sampling SN	Compressor	Threshold (dB)	-18	A variation on program 28, intended for sampled snare drum sounds.
			Ratio (:1)	4	
			Attack (ms)	8	
			Outgain (dB)	8.0	
			Knee	hard	
			Release (ms)	354	
31	Hip Comp	Compander (S)	Threshold (dB)	-23	A variation on program 28, intended for sampled sound loops.
			Ratio (:1)	20	
			Attack (ms)	15	
			Outgain (dB)	0.0	
			Width (dB)	15	
			Release (ms)	163	
32	Solo Vocal1	Compressor	Threshold (dB)	-20	Compressor program suited for use with solo vocals.
			Ratio (:1)	2.5	
			Attack (ms)	31	
			Outgain (dB)	2.0	
			Knee	1	
			Release (ms)	342	

#	Title	Type	Parameter	Value	Description
33	Solo Vocal2	Compressor	Threshold (dB)	-8	A variation on program 32.
			Ratio (:1)	2.5	
			Attack (ms)	26	
			Outgain (dB)	1.5	
			Knee	3	
			Release (ms)	331	
34	Chorus	Compressor	Threshold (dB)	-9	A variation on program 32, intended for chorus vocals.
			Ratio (:1)	1.7	
			Attack (ms)	39	
			Outgain (dB)	2.5	
			Knee	2	
			Release (ms)	226	
35	Click Erase	Expander	Threshold (dB)	-33	Expander program to remove click track sounds that may bleed out of the musicians monitor headphones.
			Ratio (:1)	2	
			Attack (ms)	1	
			Outgain (dB)	2.0	
			Knee	2	
			Release (ms)	284	
36	Announcer	Compander (H)	Threshold (dB)	-14	Hard compander program to reduce the music level when the announcer speaks, making the voice clearer.
			Ratio (:1)	2.5	
			Attack (ms)	1	
			Outgain (dB)	-2.5	
			Width (dB)	18	
			Release (ms)	180	
37	Limiter1	Compander (S)	Threshold (dB)	-9	A soft-knee compander program with a slow release.
			Ratio (:1)	3	
			Attack (ms)	20	
			Outgain (dB)	-3.0	
			Width (dB)	90	
			Release (ms)	3.90 s	
38	Limiter2	Compressor	Threshold (dB)	0	A compressor program using the peak-stop style.
			Ratio (:1)	∞	
			Attack (ms)	0	
			Outgain (dB)	0.0	
			Knee	hard	
			Release (ms)	319	
39	Total Comp1	Compressor	Threshold (dB)	-18	Compressor intended to reduce the overall volume level. Use it on the stereo output during mix-down. It can also be used with the stereo input.
			Ratio (:1)	3.5	
			Attack (ms)	94	
			Outgain (dB)	2.5	
			Knee	hard	
			Release (ms)	447	
40	Total Comp2	Compressor	Threshold (dB)	-16	A variation of program 39 with greater compression.
			Ratio (:1)	6	
			Attack (ms)	11	
			Outgain (dB)	6.0	
			Knee	1	
			Release (ms)	180	

Scene Memories

15

In this chapter...

About Scene Memories	164
What's Stored in Scene Memories?	164
What's the Edit Buffer & Edit Indicator?	164
Scene Memory 00	165
Scene Memory Display Area	165
Scene Memory Buttons	165
Storing Mix Scenes	166
Recalling Mix Scenes	168
Undoing Mix Scene Recalls	169
Write Protecting Scene Memories	170
Editing Scene Memory Titles	171
Sorting Scene Memories	172
Setting a Fade Time	173
Recalling Scene Data Safely	174

About Scene Memories

Scene memories are memory locations that are used to store mix scenes. A mix scene consists of all 03D mix settings (i.e., EQ, fader positions, and so on). There are 50 scene memories, and they can be titled for easy identification. Scene memories can be stored and recalled in three ways:

- Manually using the using SCENE MEMORY [STORE] and [RECALL] buttons or Scene Mem. display page
- Using MIDI Program Change messages from a computer or MIDI sequencer
- Using the 03D automix

Scene memory data can be backed up to an external MIDI device, such as a MIDI data filer, using MIDI Bulk Dump. See Bulk Dump on page 242 for more information. A scene memory to Program Change assignment table is provided on page 267.

What's Stored in Scene Memories?

Virtually all 03D mix settings are stored in a scene memories. Settings that are not stored consist mainly of analog controls and switches. Namely, the 26 dB [PAD] switches, GAIN controls, SOLO/2TR IN switch, MONITOR OUT LEVEL control, PHONE LEVEL control, display contrast, and on the rear panel, the phantom power switches, REC OUT SOURCE SELECT switch, and WORD CLOCK 75Ω termination switch.

The following types of data are not stored in scene memories: 03D Setup data, MIDI Program Change Map, MIDI Control Change Map, Scene Memory data, EQ library, Dynamics library, Effects library, Channel library, Automix data, MIDI Remote. You can, however, back up this data to an external MIDI device, such as a MIDI data filer, using MIDI Bulk Dump. See Bulk Dump on page 242 for more information.

What's the Edit Buffer & Edit Indicator?

The Edit Buffer refers to a memory area inside the 03D that contains the current mix settings. When a mix scene is stored, the mix settings in the Edit Buffer are written to the selected scene memory. When a mix scene is recalled, the contents of the selected scene memory are placed in the Edit Buffer, making them the current mix settings.

When a parameter is adjusted after a mix scene has been recalled, the EDIT indicator appears in the scene memory area of the display. This indicates that the current mix settings (i.e., those in the Edit Buffer) no longer match those of the mix scene that was recalled last. The following illustration shows the EDIT indicator.

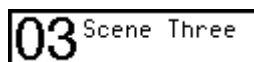

Scene memory 03 has just been recalled. So the contents of the Edit Buffer match those of the scene memory

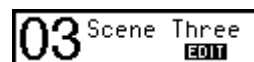

A parameter has been changed since scene memory 03 was recalled. So the contents of the Edit Buffer no longer match those of the scene memory, as the EDIT indicator shows

The Edit Buffer settings are remembered when the 03D is turned off. So they don't have to be stored to a scene memory before the 03D is turned off.

Scene Memory 00

Scene memory 00 is a little different to scene memories 1 through 50. It's a read-only memory and contains the initial 03D settings. You can recall it, but you cannot store it. When you want to reset all mix settings to their initial values, recall scene memory 00.

Scene Memory Display Area

The scene memory area of the display shows the selected scene memory number, title, whether or not the scene memory is read-only or protected, and the status of the Edit Buffer. Only scene memory 00 is read-only. Any scene memory can be write protected. When a scene memory other than the one recalled last is selected, the scene memory number flashes. If the scene memory that was recalled last is selected again or a different scene memory recalled, the number stops flashing.

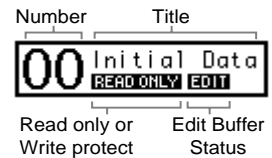

Scene Memory Buttons

The scene memory buttons are used to select, store, and recall scene memories, and undo and redo scene memory recalls.

[▲] [▼]—These buttons are used to select scene memories. The [▲] button increases the scene memory number; the [▼] button decreases it. To select a scene memory, press the relevant button several times or hold it down until the number of the required scene memory appears.

STORE—This button is used to store the current mix scene (i.e., the contents of the Edit Buffer) to the selected scene memory.

RECALL—This button is used to recall the selected scene memory.

UNDO/REDO—This button is used to undo the last scene memory recall. Pressing it again undoes the undo operation. This button does not work when there is no scene memory recall to undo, such as when the 03D is first turned.

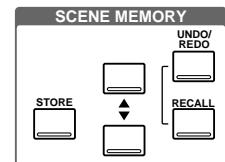

Storing Mix Scenes

Mix scenes can be stored using the SCENE MEMORY buttons or the Scene Mem. page. Both methods are explained below. When a mix scene is stored, all data in the selected scene memory is overwritten. So be careful not to overwrite an important mix scene. Scene memories can be write protected to prevent accidental data loss. See Write Protecting Scene Memories on page 170 for more information. Scene memory 00 is a read-only memory, so it cannot be used to store a mix scene.

Note: When storing mix scenes, make sure that there are no mix settings in the Edit Buffer that you do not want to store. Maybe some settings have been adjusted accidentally, or by someone else. If you are not sure of the Edit Buffer's exact contents, recall the last mix scene, make the adjustments that you really want, and then store the mix scene. You may want to store the current mix settings to an unused scene memory, just in case.

Using the SCENE MEMORY Buttons

1. Use the SCENE MEMORY [▲] and [▼] buttons to select the scene memory to which you want to store the current mix scene.

The number and title of each scene memory flashes as it's selected. Scene memories that do not contain data have the title No Data!

2. Press the [STORE] button.

The Title Edit dialog box appears.

The Title Edit dialog box doesn't appear if the Store Confirmation preference is set to OFF. See STORE CONFIRMATION on page 213 for more information.

3. Enter a title for the mix scene.

See Title Edit Dialog Box on page 33 for more information.

4. Press OK on the Title Edit dialog box.

The mix scene is stored to the selected scene memory, the scene memory number stops flashing, and the EDIT indicator disappears.

Using the Scene Mem. Page

1. Use the [SCENE MEMORY] button to locate the Scene Mem. page shown below.

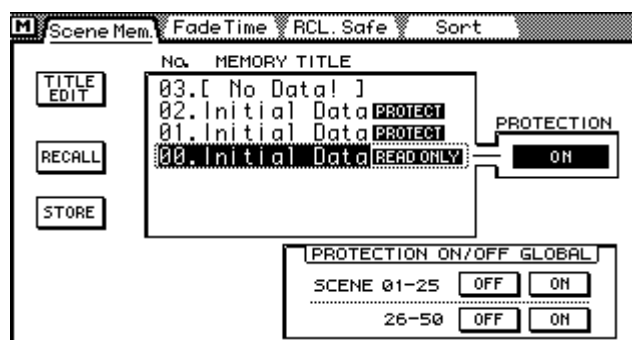

2. Use the cursor buttons to select the scroll box listing the scene memories.
3. Use the PARAMETER wheel to scroll through the scene memory list. If you are using a mouse, position the mouse cursor over the parameter box,

press and hold the left mouse button, and then drag the mouse.

The number and title of each scene memory flashes as it's selected. Scene memories that do not contain data have the title No Data!

- 4. Use the cursor buttons to select the STORE switch, and then press the [ENTER] button (you could press the [STORE] button instead).**

The Title Edit dialog box appears.

- 5. Enter a title for the mix scene.**

See Title Edit Dialog Box on page 33 for more information.

- 6. Press OK on the Title Edit dialog box.**

The mix scene is stored to the selected scene memory, the scene memory number stops flashing, and the EDIT indicator disappears.

Recalling Mix Scenes

Mix scenes can be recalled using the SCENE MEMORY buttons, the Scene Mem. page, MIDI Program Change messages, or automix. Each of these methods is explained below.

Note: When recalling mix scenes, be aware that volume levels may change suddenly as channels are switched on and faders moved. Nobody likes sudden surprises or speaker damage.

To prevent mix scenes being recalled accidentally, a preference can be set so that the 03D displays a confirmation dialog box during the recall process. See RECALL CONFIRMATION on page 213 for more information.

Using the SCENE MEMORY Buttons

1. Use the SCENE MEMORY [▲] and [▼] buttons to select the scene memory containing the mix scene that you want to recall.
The number and title of each scene memory flashes as it's selected. Scene memories that do not contain data have the title No Data!, and cannot be recalled.
2. Press the [RECALL] button.
The mix scene is recalled, the scene memory number stops flashing, and the EDIT indicator disappears.

Using the Scene Mem. Page

1. Use the [SCENE MEMORY] button to locate the Scene Mem. page shown below.

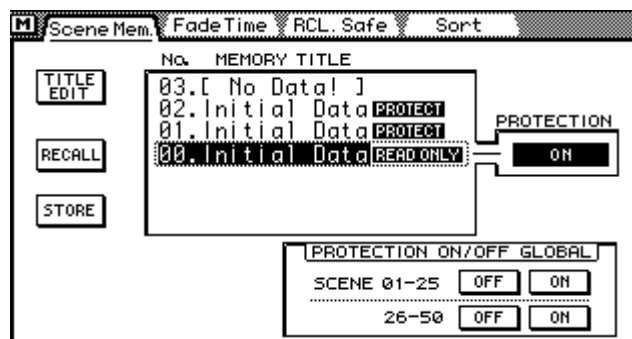

2. Use the cursor buttons to select the scroll box listing the scene memories.
3. Use the PARAMETER wheel to scroll through the scene memory list. If you are using a mouse, position the mouse cursor over the parameter box, press and hold the left mouse button, and then drag the mouse.
The number and title of each scene memory flashes as it's selected. Scene memories that do not contain data have the title No Data!
4. Use the cursor buttons to select the RECALL switch, and then press the [ENTER] button (you could press the [RECALL] button instead).
The mix scene is recalled, the scene memory number stops flashing, and the EDIT indicator disappears.

Using MIDI Program Change Messages

MIDI Program Change messages can be used to recall mix scenes, providing snapshot-style mix automation. Program Change messages can be transmitted from a controlling computer, MIDI sequencer, or MIDI keyboard to the 03D to recall mix scenes. For example, most MIDI keyboards transmit a Program Change message when a voice is selected. This could be used to recall the corresponding mix scene on the 03D. So with just one button press, your synthesizer, 03D, and other MIDI equipment is reconfigured ready for the next song or scene.

When a mix scene is recalled using the [RECALL] button or Scene Mem. page on the 03D, the 03D transmits a Program Change message. This allows simultaneous mix scene recalls on cascaded 03Ds. It can also be used to recall programs on other MIDI equipment, such as an effects program on an external effects processor, or a voice on a synthesizer. Recalling scene memory #10, for example, could be used to recall voice #10 on a synthesizer. Program Changes messages transmitted by the 03D can be recorded by a MIDI sequencer along with other MIDI data. During playback, mix scenes can then be recalled automatically. Your MIDI sequencer's edit functions can be used to edit and enter new Program Change messages. Automated mix scene recalls can also be achieved using the 03D's built-in automix function.

To recall mix scenes using MIDI Program Change messages you must:

1. **Connect MIDI equipment capable of transmitting Program Change messages to the 03D's MIDI IN connector.**
2. **Configure the 03D so that is able to receive Program Change messages. See MIDI Setup on page 235 for more information.**
3. **Assign Program Change messages to scene memories. See Program Change Assign on page 239 for more information.**

Using Automix

Manual mix scene recalls can be recorded in an automix. When the automix is replayed, the mix scenes are then recalled automatically. See Automix on page 175 for more information.

Undoing Mix Scene Recalls



Mix scene recalls can be undone using the SCENE MEMORY [UNDO/REDO] button. When this button is pressed, the 03D returns to the mix settings that were active before the last mix scene was recalled. This is useful when a mix scene is recalled by mistake. Pressing it again redos the last mix scene recall, making the last mix scene recall active. This button does not work when there is no scene memory recall to undo, such as when the 03D is first turned.

The [UNDO/REDO] button can also be used for A/B mix comparisons. To compare different mix settings, for example, store them to two scene memories. Recall one scene memory, then the other. The [UNDO/REDO] button can then be used to quickly toggle between the two mixes, allowing you to concentrate on the sound.

Write Protecting Scene Memories

Mix scenes can be protected against accidental erasure by write protecting scene memories. Mix scenes cannot be stored to write-protected scene memories. Scene memory data received as MIDI Bulk Dump data is ignored when the corresponding scene memory is write protected. Scene memories can be write protected individually, or in blocks of 25 (01–25 or 26–50). Write protection settings are made on the Scene Mem. page shown below.

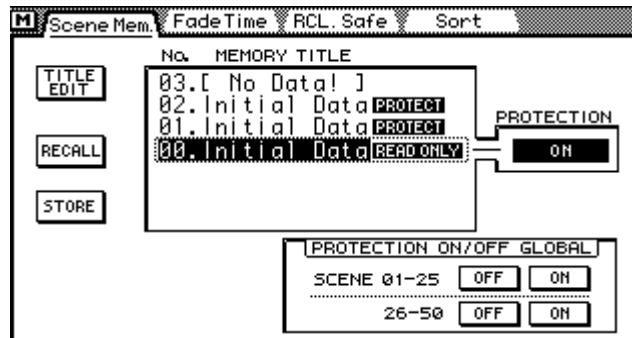

Write Protecting a Single Scene Memory

1. Use the [SCENE MEMORY] button to locate the Scene Mem. page.
2. Select the scene memory using the PARAMETER wheel, SCENE MEMORY [▲] and [▼] buttons, or mouse.
3. Use the cursor buttons to select the PROTECTION switch.
4. Press the [ENTER] button.



If you are using a mouse, simply click the PROTECTION switch.

When a scene memory is write protected, the word PROTECT appears next to its number and title in the scroll box, and in the scene memory area at the top of the display.

To turn off the write protection, press the [ENTER] button again. If you are using a mouse, simply click the PROTECTION switch.

Write Protecting a block of Scene Memories

1. Select the ON switch corresponding to the group of scene memories that you want to protect: 01–25 or 26–50.
2. Press the [ENTER] button.

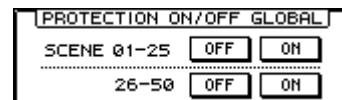

If you are using a mouse, simply click the corresponding ON switch.

To turn off the write protection, select the corresponding OFF switch and press the [ENTER] button. If you are using a mouse, simply click the OFF switch.

Editing Scene Memory Titles

Scene memory titles can be edited at anytime. You don't have to recall a scene memory to edit its title. Only scene memories that contain data can have their titles edited. Title editing is performed on the Scene Mem. page.

1. Use the [SCENE MEMORY] button to locate the Scene Mem. page shown below.

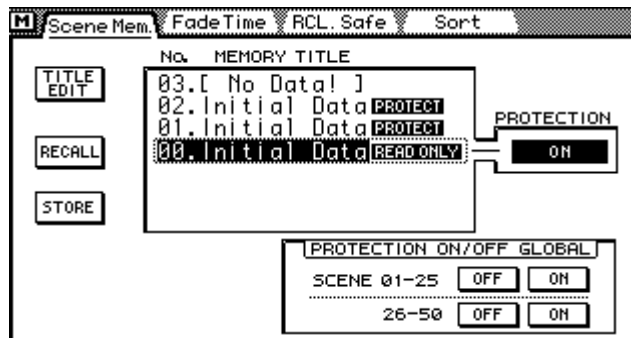

2. Select the scene memory using the PARAMETER wheel, SCENE MEMORY [▲] and [▼] buttons, or mouse.
3. Use the cursor buttons to select the TITLE EDIT switch, and then press the [ENTER] button.
If you are using a mouse, simply click the TITLE EDIT switch.
The Title Edit dialog box appears.
4. **Edit the scene memory title.**
See Title Edit Dialog Box on page 33 for more information.
5. **When you've finished, press OK on the Title Edit dialog box.**

Sorting Scene Memories

Scene memories can be sorted using the Sort page.

1. Use [SCENE MEMORY] button to locate the Sort page shown below.

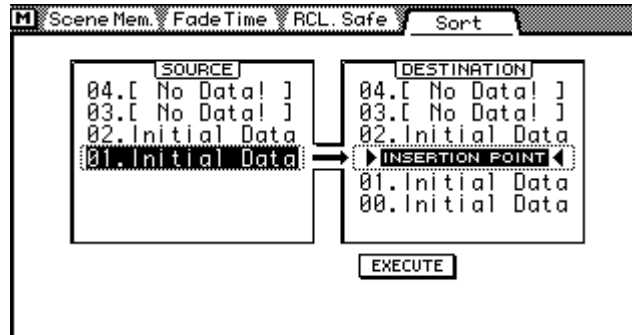

2. Use the PARAMETER wheel or mouse to select a scene memory from the SOURCE list.
3. Use the cursor buttons to move the cursor over to the DESTINATION list.
4. Use the PARAMETER wheel or mouse to select the insertion point.
5. Use the cursor buttons to select the EXECUTE switch.
6. Press the [ENTER] button.

If you are using a mouse, simply click the EXECUTE switch.

The source scene memory is renumbered.

Setting a Fade Time

The Fade Time page can be used to specify a common fade time at which fader levels move to their new positions. This can be used to create cross fades between scenes. The fade time can be applied to faders individually. Once the Fade Time parameters have been set, they must be stored to a scene memory before they can be used. When the scene memory is recalled, its fade time settings are used. When another scene memory is recalled, the fade time settings of that scene memory are used.

1. Use [SCENE MEMORY] button to locate the Fade Time page shown below.

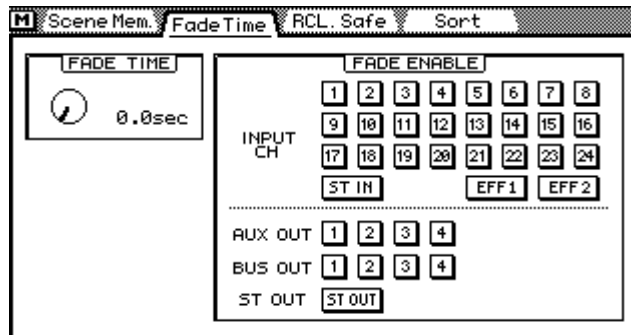

2. Select the FADE TIME control.
3. Use the PARAMETER wheel or mouse to set the FADE TIME.
The FADE TIME can be set from 0.0 to 10.0 seconds in 0.1 second steps.
As the only rotary control on the Fade Time page, the FADE TIME control can be adjusted using the PARAMETER wheel regardless of the cursor position.
4. Use the cursor buttons to select faders and the [ENTER] button to enable them.
If you are using a mouse, simply click the switches.
5. Store the current mix settings to a scene memory.
The fade time parameters are stored along with other mix settings. When this scene memory is recalled, enabled faders move to their new positions at the specified fade time.

Recalling Scene Data Safely

When a mix scene is recalled, mix settings that do not match those in the Edit Buffer are updated. In some situations, you may want to retain the mix settings of certain channels. This is possible using the Recall Safe function on the RCL. Safe page.

1. Use the [SCENE MEMORY] button to locate the RCL. Safe page shown below.

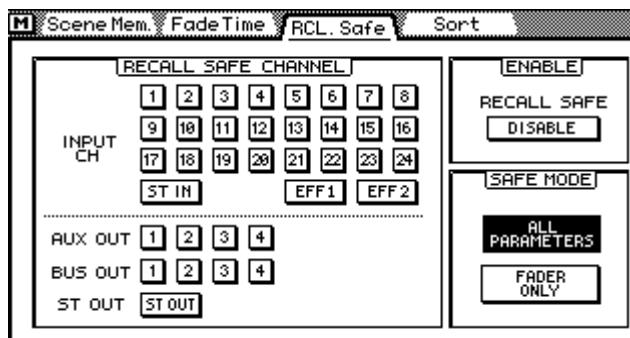

2. Use the cursor buttons to select channels and the [ENTER] button to make them safe.

If you are using a mouse, simply click the switches.

3. Use the cursor buttons to select a SAFE MODE, and the [ENTER] button to activate it.

In ALL PARAMETERS mode, all parameters are safe. In FADERS ONLY mode, just the faders are safe.

4. Use the cursor buttons to select the ENABLE switch and press the [ENTER] button to enable the Recall Safe function.

If you are using a mouse, simply click the ENABLE switch.

The ENABLE switch works as a master Recall Safe on/off switch, so you don't have to turn off individual channels when you want a scene recall to update all channels.

When a mix scene is recalled, providing that the master ENABLE switch is on, mix settings are not applied to safe channels.

The Recall Safe settings are stored as part of the 03D Setup data. They are not stored in scene memories.

If you recall a mix scene that contains stereo pair or group settings, and one of the channels in the stereo pair or group is set as a safe channel, the pair or group is cancelled and the data applied only to the other channel.

If you try recall a mix scene that contains bus or aux pair settings, or surround pan settings, that are different to those in the Edit Buffer, a message appears stating that you cannot recall the mix scene. This is because the mix scene data is incompatible with the Edit Buffer data.

Automix

16

In this chapter...

About Automix	176
Creating a New Automix	180
Enabling Automix	180
Setting the Time Base	181
Setting an Automix Offset	182
Safe Channels	183
Selecting Parameters for Recording	184
Recording an Automix	185
Playing Back an Automix	187
Rerecording Events	188
Automix Punch-In/Punch-Out	189
Editing Fader Moves On-the-fly	190
Editing Events Off-line	193
Extracting Events	198
Undoing Automix Operations	200
Clearing the Undo Buffer	201
Storing Automixes	202
Recalling Automixes	203
Swapping the Current Automix	204
Editing Automix Titles	205
Clearing Automix Memories	206

About Automix

The 03D's Automix function provides dynamic mix automation referenced to an external timecode source. The external timecode can be either MTC or MIDI Clock. The automix start time can be offset relative to the external timecode. Automix can be used to record and playback fader moves, channel mutes, EQ changes, pan, and more. In addition, mix scene, EQ, channel, effects, and dynamics library recalls can be included in an automix, combining snapshot and dynamic automixing. Mix changes recorded in an automix are called events. Recorded events can be edited off-line. Fader moves can be edited on-the-fly, or off-line using the trim function. The undo function can be used to revert to the previous automix after making changes that you do not want to keep. Channels set as safe channels are excluded from automix playback.

What's Recorded in an Automix?

The following mix parameters can be recorded in an automix.

Fader moves	Normal CH faders, CH AUX sends, & CH Effect sends
Channel Mutes	Channel [ON] buttons
EQ	EQ
Pan	Pan, balance, surround pan
Others	Scene memory recalls. Channel, EQ, effects, and dynamics library recalls. Scene recall safe channel settings. Transmitted MIDI Program Changes.

The following parameters are not recorded in an automix: surround mode selection, input attenuators (EQ page), Bus to ST pan and on/off, aux pair pan, and 3+2+1 surround subwoofer trim. To change these parameters in an automix, store the desired setting in a mix scene and use the automix to recall that scene. Input attenuator and aux pair pan settings can also be stored in a channel program, which can be recalled by the automix.

Automix Pages

The Automix function has five display pages: Main, Memory, Fader Edit, Event Edit, and Extract. These are accessed using the [AUTOMIX] button. Common operations are performed on the Main page shown below, which includes transport controls.

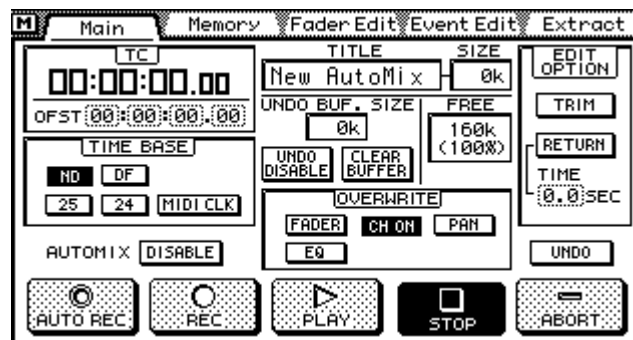

Current Automix

The current automix is the currently active automix. When the current automix is stored, its data is written to the selected automix memory. When an automix is recalled, the contents of the selected automix become the current automix.

The current automix is remembered when the 03D is turned off. So they don't have to store the current automix before the 03D is turned off.

Automix Memory

The automix function has 160 kilobytes of memory, which can store approximately 30,000 to 80,000 events. This memory is shared dynamically between the four automix memories, the current automix, and undo buffer. Automix data can be backed up to an external MIDI device, such as a MIDI data filer, using MIDI Bulk Dump. See Bulk Dump on page 242 for more information.

TITLE	SIZE
New AutoMix	0k

The SIZE window next to the automix title displays the size of the current automix. The TITLE and SIZE boxes shown here appear on the Main and Memory pages.

FREE
159k (99%)

The FREE memory window displays the amount of free memory in kilobytes and as a percentage of total memory. The FREE window shown here appears on the Main and Memory pages.

UNDO BUF. SIZE
0k

The UNDO BUF. SIZE window displays the amount of memory being used by the undo buffer. You can turn the undo buffer on and off, and clear its contents at anytime, freeing up memory for automix recording. See Undoing Automix Operations on page 200 for more information.

NO.	LIBRARY	TITLE	SIZE
03.	[No Data!] 0k
02.	[No Data!] 0k
01.	[No Data!] 0k

The size of each automix memory can be checked on the Memory page.

When an automix is recorded, or MIDI Bulk Dump function used, a portion of the automix memory is used as a temporary buffer. For this reason, the total memory used by the current automix, undo buffer, the four automix memories, and the amount shown by the free memory indicator may not add up to exactly 160K.

Time Counter & Offset Displays

The counter display depends on the selected time base: MTC or MIDI CLK. See Setting the Time Base on page 181 for more information.

TC Counter

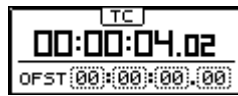

The TC counter displays hour, minute, second, and frame information of the incoming MTC signal. An offset can be specified using the OFST parameter. When an offset is set, events in the current automix are moved by the specified amount. See Setting an Automix Offset on page 182 for more information.

MEAS/BEAT/CLK Counter



The MEAS/BEAT/CLK counter displays measure, beat, and MIDI Clock information of the incoming MIDI Clock signal. The display shows 001.01.01 at the start point. With a 4/4 time signature, one step before this would be -01.04.24. An offset from -99 to 999 measures can be specified using the OFST parameter. A negative offset can be used to advance automix playback by a specific number of measures. A time signature for automix start can be set. See Setting an Automix Offset on page 182 for more information.

Automix Transport Controls

Automix has five transport controls: AUTO REC, REC, PLAY, STOP, and ABORT. Use the cursor buttons to select them and the [ENTER] button to activate them.



AUTO REC—Pressing this switch engages Auto Rec mode, which is indicated by a highlighted AUTO REC switch. In this mode, automix recording can be performed repeatedly. Recording starts as soon as the 03D receives timecode or a MIDI Start or Continue message. You cannot start recording events until you select a channel for automix recording, however, using the [SEL] buttons.

REC—Pressing this switch engages Rec Ready mode, which is indicated by a flashing REC switch. Rec Ready mode can be cancelled by pressing this switch again. The [SEL] buttons are used to select channels for recording. Automix recording starts when the 03D receives timecode or a MIDI Start or Continue message. The REC switch appears highlighted when recording starts. When automix recording is started with the AUTO REC switch, recording can be performed repeatedly. When it is started with the REC switch, however, it is performed only once.

PLAY—If the Automix function is enabled, playback starts automatically when the 03D receives timecode or a MIDI Start or Continue message. This is Auto Play mode. Auto Play can, however, be cancelled by pressing the STOP switch. Pressing the PLAY switch reengages Auto Play mode.

STOP—Pressing this switch stops automix playback or recording. When automix recording is stopped, the newly recorded data becomes the current automix. If the Undo function is enabled, the previous automix data is copied to the undo buffer. Playback or recording also stops when the external timecode source is stopped.

ABORT—Pressing this switch aborts automix playback or recording. When automix recording is aborted, the newly recorded data is discarded. If the Undo function is enabled, the newly recorded data is copied to the undo buffer. You must press the

ABORT switch while recording is in progress. Pressing it when recording has already stopped will not work. If memory is low and the undo buffer is disabled, you may not be able to abort playback or recording. In this case, the ABORT switch appears gray.

First Mix Scene

Each automix starts with a mix scene recall event that recalls the first mix scene. The first mix scene sets the mix settings as required at the beginning of an automix. Without the first mix scene, mix settings would remain the same as when automix playback was stopped.

When a new automix is created, the mix scene last stored or recalled is automatically selected as the first mix scene. You can select another mix scene as the first mix scene on the Event Edit page. See *Editing Events Off-line* on page 193 for more information.

When a mix scene is recalled in an automix, the mix scene recall safe channel settings are effective.

“Midnight Phenomenon” & Offset

The “midnight Phenomenon” refers to the discontinuity that occurs when a timecode passes through midnight. As an automix can be offset, this is not a problem with the 03D. However, the 03D must determine whether a received timecode value refers to a point before the start of an automix or to a point in the middle. For example, an automix runs from 23:00 through midnight. Then, the 03D receives a timecode value of 22:30. That could be interpreted as either 22:30 before the automix start or 22:30 after the start. The 03D uses the following method to determine the correct point: If the received timecode value is within one hour of the automix start (00:00:00.00 or offset value), it is interpreted as being before the automix start, and the first mix scene is recalled. Otherwise, it’s interpreted as being after the start point and the automix is played from that point.

Note: If you start recording at a time before the specified offset, the offset setting is automatically moved to an earlier point so that the mix adjustments can be recorded. The time positions of existing events, however, remain the same.

Creating a New Automix

New automixes are created on the Memory page. When a new automix is created, the contents of the current automix are copied to the undo buffer, presuming that the undo function is turned on. See Undoing Automix Operations on page 200 for more information.

1. Use the [AUTOMIX] button to locate the Memory page.

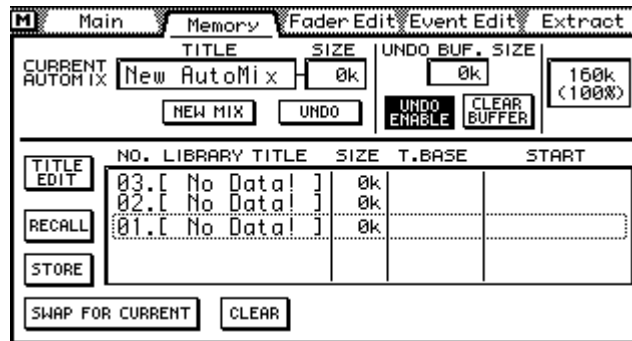

2. Use the cursor button to select the NEW MIX switch.
3. Press the [ENTER] button.
If you are using a mouse, simply click the NEW MIX switch.
The Title Edit dialog box appears.
4. Enter a title for the automix.
See Title Edit Dialog Box on page 33 for more information.
5. Press OK on the Title Edit dialog box.

A new automix is created.

The size of the current automix reverts to 0k. Although the contents of the current automix are discarded, the following settings remain as they were set for the previous automix: time base, title, offset, and the number of the scene last recalled or stored. Scene recall safe channel settings are all turned off.

The mix scene last stored or recalled is selected as the first mix scene. You can select another mix scene as the first mix scene on the Event Edit page. See Editing Events Off-line on page 193 for more information.

Note: The time base must be set before recording events in a new automix. Once events have been recorded, the time base settings cannot be changed.

Enabling Automix

The automix function can be turned on and off using the AUTOMIX ENABLE switch on the Main automix page. When turned off, recording and playback are disabled.

1. Use the cursor button to select the AUTOMIX ENABLE switch.
2. Press the [ENTER] button to toggle automix on and off.

If you are using a mouse, simply click the AUTOMIX ENABLE switch.

AUTOMIX DISABLE Automix OFF.

AUTOMIX ENABLE Automix ON

When automix is enabled, automix starts automatically when MIDI Start or Continue messages or MTC are received.

Setting the Time Base

Automix requires an external timecode source. The 03D does not generate timecode internally. Automix can be used with MTC (MIDI Timecode) or MIDI Clock. Timecode signals are input using the MIDI IN or TO HOST connection. See MIDI Connectors & TO HOST on page 232 for more information. The 03D's time base settings must be set to match the incoming timecode signal. Time base settings are made in the TIME BASE section of the Main automix page.

1. Use the [AUTOMIX] button to locate the Main page.

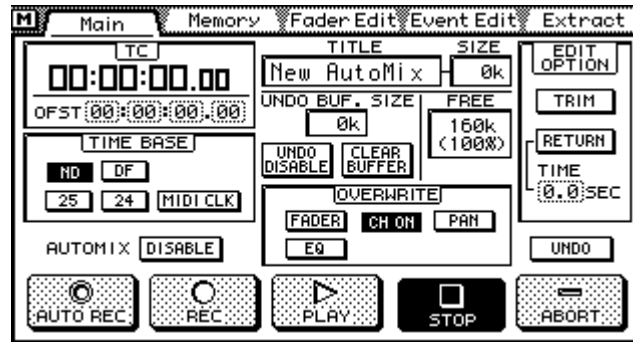

2. Use the cursor buttons to select a time base.

The following time bases are available:

ND—MTC 29.97 frame/sec non-drop or 30 frame/sec non-drop

DF—MTC 29.97 frame/sec drop or 30 frame/sec drop

25—MTC 25 frame/sec

24—MTC 24 frame/sec

MIDI CLK—MIDI Clock



3. Press the [ENTER] button to activate the selected time base.

Note: The time base must be set before recording events in a new automix. Once events have been recorded, the time base settings cannot be changed.

The 03D supports the following MIDI messages: Timing Clock (F8H), Start (FAH), Continue (FBH), Stop (FCH), Song Position Pointers (F3H, **H, **H), and MTC Quarter Frame Messages (F1H, **H).

In Auto Play mode, automix starts automatically when MTC or a MIDI Start or Continue message is received. Likewise, automix stops automatically when the MTC stops or a MIDI Stop message is received.

The maximum recording time for the ND and DF time bases is 19 hours. For the 25 and 24 time bases, it's 23 hours. For MIDI Clock, it's two million MIDI Clocks.

When a timecode of a different frame rate to that set for the current automix is received, a warning message appears. If the frame rate is within ± 2 frames, however, the automix will synchronize to it but will be offset by the difference in rates.

Setting an Automix Offset

By setting an offset, automix events can be moved relative to the incoming timecode or a MIDI Start message. The offset parameters depend on the selected time base. See *Setting the Time Base* on page 181 for information about setting the time base.

1. Use the [AUTOMIX] button to locate the Main page.

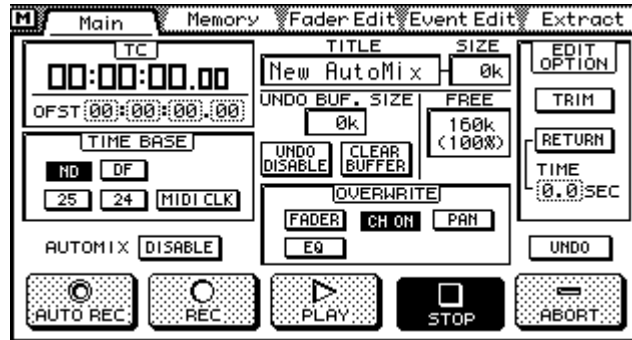

2. Use the cursor buttons to select the OFST fields.
3. Use the PARAMETER wheel to set the OFST fields.

If you are using a mouse, position the mouse cursor over an OFST field, press and hold the left mouse button, and then drag the mouse.

TC Counter

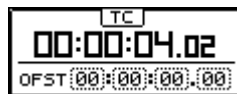

When MTC is used as the time base, the offset is specified in hours, minutes, seconds, and frames. When an offset is set, events in the current automix are moved by the specified amount.

MEAS/BEAT/CLK Counter



When MIDI Clock is used as the time base, the offset is specified in measures. An offset from –99 to 999 measures can be specified using the OFST parameter. A negative offset can be used to advance automix playback by a specific number of measures.

A time signature for automix start can be set. The number of beats can be set from 1 to 16, and the type of beat can be set to 2, 4, 8, or 16.

Safe Channels

Channels set as safe channels are excluded from automix playback. This allows you to perform real-time adjustments to a channel while automix plays, for example, in a live concert or theater situation.

1. Use the [AUTOMIX] button to locate the Fader Edit page.

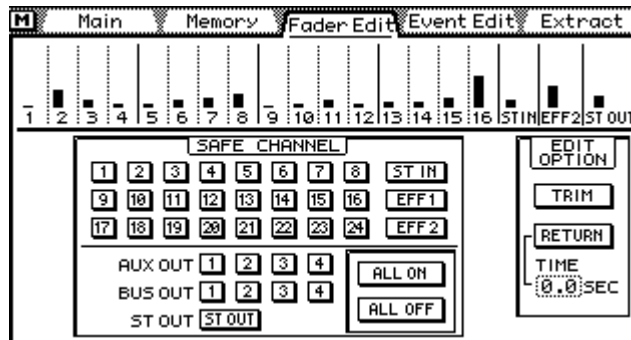

2. Use the cursor buttons to select the SAFE CHANNEL switches, and the [ENTER] button to set them.

If you are using a mouse, simply click the SAFE CHANNEL switches.

- Channel not safe—automix events already recorded for this channel are played back.
- Channel safe—automix events already recorded for this channel are not played back.

ALL ON These two switches are used to turn on and off all channel safe switches.

ALL OFF

Note that the safe settings on the Fader Edit page do not affect mix scene recalls. If a mix scene is recalled by an automix, channel parameters are updated regardless of these safe settings. To protect a channel completely, use the RECALL SAFE CHANNEL function on the scene memory RCL. Safe page. See Recalling Scene Data Safely on page 174 for more information.

Note: During automix recording these settings are ignored, and existing automix data plays as normal.

Selecting Parameters for Recording

You can select parameters for automix recording and rerecording using the OVERWRITE switches on the Main page.

1. Use the [AUTOMIX] button to locate the Main page.

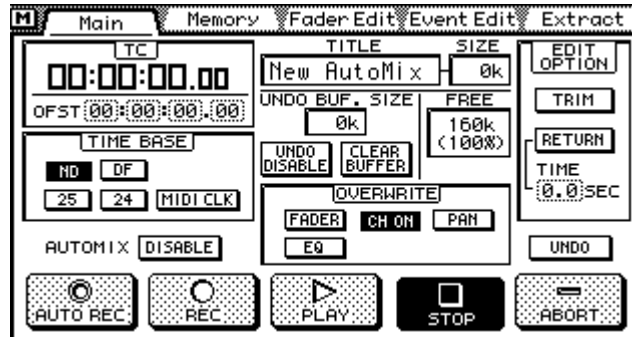

2. Use the cursor buttons to select the OVERWRITE switches, and the [ENTER] button to set them.

If you are using a mouse, simply click the OVERWRITE switches.

Parameters are selected for recording when the corresponding switch is highlighted.

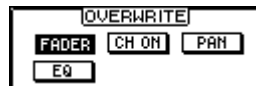

The following table lists the parameters affected by the OVERWRITE switches.

Switch	Parameters
FADER	Normal CH faders, CH AUX sends, & CH Effect sends
CH ON	Channel [ON] buttons
EQ	EQ
Pan	Pan, balance, surround pan

Scene memory recalls, channel, EQ, effects, and dynamics library recalls, scene recall safe channel settings are recorded regardless of the OVERWRITE switch settings.

The following parameters are not recorded in an automix: surround mode selection, input attenuators (EQ page), Bus to ST pan and on/off, aux pair pan, and 3+2+1 surround subwoofer trim. To change these parameters in an automix, store the desired setting in a mix scene and use the automix to recall that scene. Input attenuator and aux pair pan settings can also be stored in a channel program, which can be recalled by the automix.

Recording an Automix

This section explains how to record an automix.

1. Use the [AUTOMIX] button to locate the Memory page.

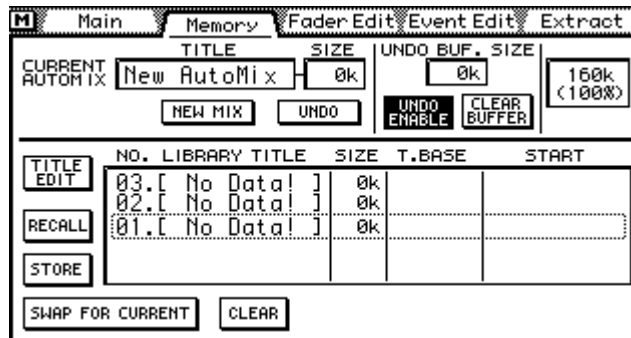

2. Create a new automix. See [Creating a New Automix](#) on page 180 for more information.
3. Use the [AUTOMIX] button to locate the Main page.

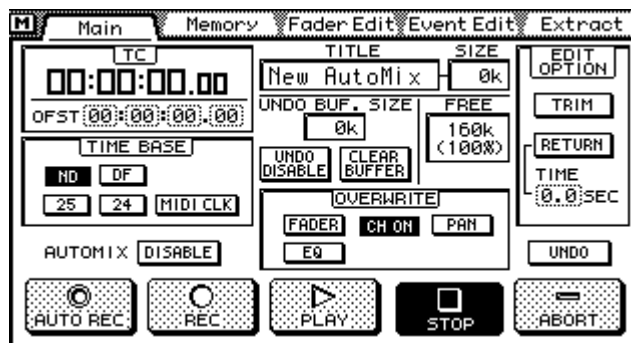

4. Turn on the automix function. See [Enabling Automix](#) on page 180 for more information.
5. Set the time base. This should be set to match the time base of the external device that is providing the timecode. See [Setting the Time Base](#) on page 181 for more information.
6. Use the cursor buttons to select the OVERWRITE switches, and the [ENTER] button to set them. See [Selecting Parameters for Recording](#) on page 184 for more information.
7. Use the cursor button to select the REC switch, and then press the [ENTER] button.

If you are using a mouse, simply click the REC switch.

The 03D engages Rec Ready mode and the REC switch flashes.

The [SEL] button indicator of the selected channel goes off. The [SEL] buttons now function as channel record select buttons.

8. Use the [SEL] and [MIXING LAYER] buttons to select a channel for automix recording. See [Mixing Layer](#) on page 31 for more information.

The indicator of the selected channel's [SEL] button flashes.

When the Mixing Layer is changed, all [SEL] buttons are turned off.

During automix recording, parameter changes, such as EQ, pan, and so on, apply to the channel selected in this step. You can select several channels and record fader moves and mute events for those channels because each channel has its own fader and [ON] button.

Use the [FADER MODE] buttons to select aux and effects send faders for automix recording.

To swap the effect return fader between effects returns 1 and 2, use the [EFFECT 1] and [EFFECT 2] buttons. The effect return [SEL] button, which is normally used to select effects returns, is used to turn effects return editing on and off during automix recording, so it cannot be used to select the effects.

9. Start the external timecode source.

Automix recording starts and the REC switch stops flashing and appears highlighted.

The time counter displays incoming timecode.

To select another channel for EQ, pan, or other adjustments without affecting the channel selected for automix recording, hold down any one of the cursor buttons and press that channel's [SEL] button. With, for example, the EQ page selected, this could be used during automix recording to record EQ events of several channels one after another.

10. Make the required parameter changes.

As automix recording progresses and automix memory is used, the size boxes display the amount of free automix memory.

Use the faders to adjust levels and the [ON] buttons to mute channels. Events for only channels selected for automix recording are recorded.

Use the SETUP, CHANNEL CONTROL, and FADER MODE buttons to select mix parameter pages. The channel selected for automix recording will be the selected channel on these pages. Use the PARAMETER wheel, [ENTER] button, and mouse to adjust parameters.

As well as mix parameter changes, the following can be recalled: mix scenes, EQ programs, effects programs, dynamics programs, and channel programs.

When recording, faders for unselected channels are “frozen” and cannot be moved. To prevent damage, do not force these faders.

11. To stop automix recording, stop the external timecode source, or use the automix STOP switch.

The REC switch returns to normal and the STOP switch appears highlighted.

When the Undo function is enabled, a confirmation dialog box appears asking whether you want to record or abort the recorded events.

Recorded events are added to the current automix.

You can revert to the previous automix, discarding the newly recorded data using the undo function. See *Undoing Automix Operations* on page 200 for more information.

Automix recording can be stopped using the ABORT switch. If automix recording is aborted, the newly recorded data is discarded. If the Undo function is enabled, the newly recorded data is copied to the undo buffer. You must press the ABORT switch while recording is in progress. Pressing it when recording has already stopped will not work. If memory is low and the undo buffer is disabled, you may not be able to abort playback or recording. In this case, the ABORT switch appears gray.

With the first part of the automix completed, you can do one of the following:

- Play back the automix—*Playing Back an Automix* on page 187
- Record parameter changes for other channels—go back to step 6 of this procedure

- Rerecord events—*Rerecording Events* on page 188
- Use automix punch in to replace events—*Automix Punch-In/Punch-Out* on page 189
- Edit fader moves “on the fly”—*Editing Fader Moves On-the-fly* on page 190
- Edit events off-line—*Editing Events Off-line* on page 193
- Extract events—*Extracting Events* on page 198

Playing Back an Automix

If the Automix function is enabled, playback starts automatically when the 03D receives timecode or a MIDI Start or Continue message. This is Auto Play mode. Auto Play can, however, be cancelled by pressing the STOP switch. Pressing the PLAY switch reengages Auto Play mode.

Mix parameters can be adjusted as an automix plays. However, automix playback has priority. So if you move a fader that is already being moved by the automix, your movements will be ignored.

Rerecording Events

You can rerecord automix events. The overwrite switches allow you to choose which events you want to rerecord.

1. Use the [AUTOMIX] button to locate the Main page.

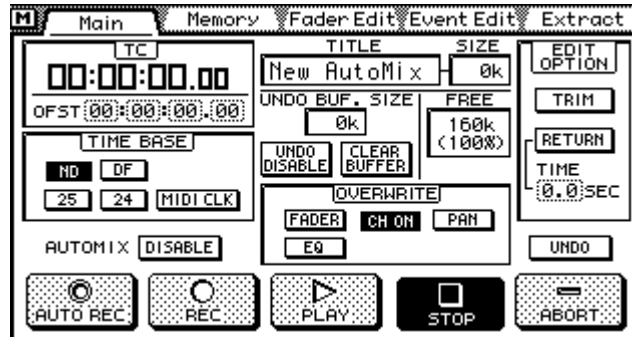

2. Use the cursor buttons to select the OVERWRITE switches, and the [ENTER] button to set them. See [Selecting Parameters for Recording](#) on page 184 for more information.
3. Use the cursor button to select the REC switch, and then press the [ENTER] button.
If you are using a mouse, simply click the REC switch.
The 03D engages Rec Ready mode and the REC switch flashes.
4. Use the [SEL] and [MIXING LAYER] buttons to select the channel you want to rerecord. See [Mixing Layer](#) on page 31 for more information.
The indicator of the selected channel's [SEL] button flashes.
5. Start the external timecode source.
Automix recording starts and the REC switch stops flashing and appears highlighted.
Previously recorded events play back.
6. Make the required parameter changes.
7. To stop automix recording, stop the external timecode source, or use the automix STOP switch.

The REC switch returns to normal and the STOP switch appears highlighted.

When the Undo function is enabled, a confirmation dialog box appears asking whether you want to record or abort the recorded events.

The rerecorded events are added to the current automix.

You can revert to the previous automix, discarding the newly recorded data using the undo function. See [Undoing Automix Operations](#) on page 200 for more information.

Automix recording can be stopped using the ABORT switch. If automix recording is aborted, the newly recorded data is discarded. If the Undo function is enabled, the newly recorded data is copied to the undo buffer. You must press the ABORT switch while recording is in progress. Pressing it when recording has already stopped will not work. If memory is low and the undo buffer is disabled, you may not be able to abort playback or recording. In this case, the ABORT switch appears gray.

Automix Punch-In/Punch-Out

You can punch-in and punch-out-style recording to rerecord events in an automix. The overwrite switches allow you to choose which events you want to rerecord.

1. Use the [AUTOMIX] button to locate the Main page.

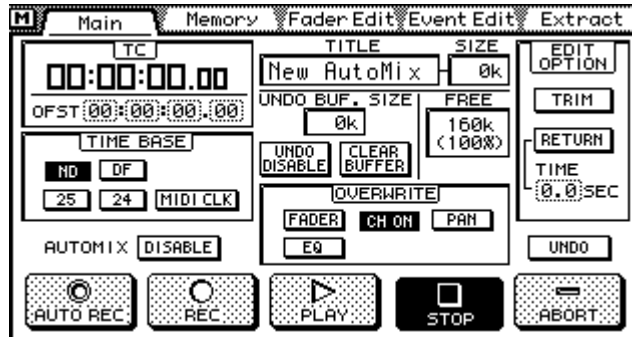

2. Use the cursor buttons to select the OVERWRITE switches, and the [ENTER] button to set them.
If you are using a mouse, simply click the OVERWRITE switches.
See *Recording an Automix* on page 185 for information about the overwrite switches.
3. Use the cursor button to select the REC switch, and then press the [ENTER] button.
If you are using a mouse, simply click the REC switch.
The 03D engages Rec Ready mode and the REC switch flashes.
4. Start the external timecode source.
Automix recording starts and the REC switch stops flashing and appears highlighted.
Previously recorded events play back.
5. To punch-in, press the channel's [SEL] button.
6. Make the required parameter changes.
7. To punch-out, press the channel's [SEL] button again.
8. To stop the automix, stop the external timecode source, or use the automix STOP switch.

When the Undo function is enabled, a confirmation dialog box appears asking whether you want to record or abort the recorded events.

The rerecorded events are added to the current automix.

Punch-in recording can be started during playback by pressing the REC switch. Likewise, punch-in recording can be started while the 03D is in Rec Ready mode by pressing the PLAY switch. In both cases, however, you must use the [SEL] buttons to select channels for automix recording.

You can revert to the previous automix, discarding the newly recorded data using the undo function. See *Undoing Automix Operations* on page 200 for more information.

Automix recording can be stopped using the ABORT switch. If automix recording is aborted, the newly recorded data is discarded. If the Undo function is enabled, the newly recorded data is copied to the undo buffer. You must press the ABORT switch while recording is in progress. Pressing it when recording has already stopped will not work. If memory is low and the undo buffer is disabled, you may not be able to abort playback or recording. In this case, the ABORT switch appears gray.

Editing Fader Moves On-the-fly

Fader moves can be edited on the fly.

1. Use the [AUTOMIX] button to locate the Main page.

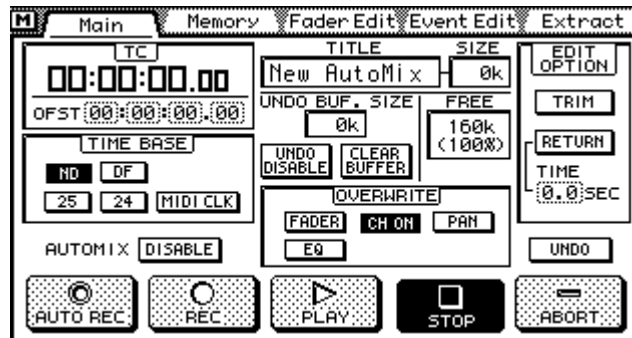

2. Set the FADER overwrite switch to on (i.e., highlighted).
See *Recording an Automix* on page 185 for information about the overwrite switches.
3. Use the [FADER MODE] buttons to select a fader mode. See *Fader Mode on page 13* for more information.
4. Set the EDIT OPTIONS.
The EDIT OPTIONS also appear on the Fader Edit page.

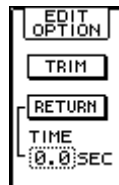

TRIM—When trim is on, fader movements adjust the level during the edit period.

RETURN—When return is on, the level returns to the position specified by the subsequent automix data at a time specified by the TIME parameter.

TIME—This parameter determines the time it takes faders to return to the position specified by subsequent automix data in the return mode. The time can be set from 0.0 to 3.0 seconds in 0.2 second steps. This setting applies only to normal channel faders. Other faders return immediately.

See *Fader Return & Trim Edit Modes* on page 192 for more information.

Faders have a resolution of 128 steps. The relationship between fader steps and signal levels is not linear. Fader steps toward the top of the fader adjust levels finely. While fader steps toward the bottom of the fader adjust levels coarsely. The trim mode uses fader steps not decibel levels to adjust fader levels. So fader response is little different when editing with this trim. The Extract function on the Extract page allows you to specify trim levels in actual decibels. See *Extracting Events* on page 198 for more information.

5. Use the cursor button to select the REC switch, and then press the [ENTER] button.

If you are using a mouse, simply click the REC switch.

The 03D engages Rec Ready mode and the REC switch flashes.

6. Start the external timecode source.

Automix recording starts and the REC switch stops flashing and appears highlighted.

Previously recorded events play back.

7. **At the point where you want to edit the fader moves, press the channel's [SEL] button.**
8. **Adjust the fader as required.**
Use the Fader Edit page to check fader positions relative to previously recorded fader data. See the following Fader Edit page for more information.
When editing in Trim mode, you cannot operate the faders while they are moving.
9. **At the point where you want stop editing, press the channel's [SEL] button again.**
How the fader continues depends on the EDIT OPTIONS.
10. **To stop the automix, stop the external timecode source, or use the automix STOP switch.**
When the Undo function is enabled, a confirmation dialog box appears asking whether you want to record or abort the recorded events.
The new fader moves are added to the current automix.
You can revert to the previous automix, discarding the new fader moves using the undo function. See Undoing Automix Operations on page 200 for more information.
Automix recording can be stopped using the ABORT switch. If automix recording is aborted, the newly recorded data is discarded. If the Undo function is enabled, the newly recorded data is copied to the undo buffer. You must press the ABORT switch while recording is in progress. Pressing it when recording has already stopped will not work. If memory is low and the undo buffer is disabled, you may not be able to abort playback or recording. In this case, the ABORT switch appears gray.

Fader Edit Page

The Fader Edit page shows fader positions relative to previously recorded fader data.

1. **Use the [AUTOMIX] button to locate the Fader Edit page.**

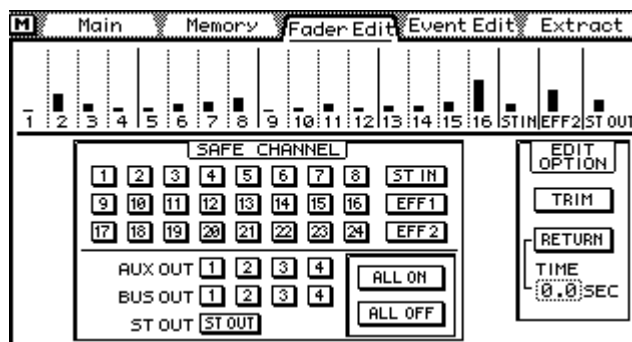

An arrow appears next to the fader being edited, indicating which way it needs to be moved to get back to the fader position previously recorded.



In this example, channel 2 fader has been lowered. The arrow pointing up indicates that the fader needs to be moved up to get back to the fader position previously recorded. Channel fader 4, on the other hand, has been raised, and the arrow pointing down indicates that the fader needs to be moved down to get back to the fader position previously recorded.

Fader Return & Trim Edit Modes

The following illustrations show how the return and trim modes affect levels.

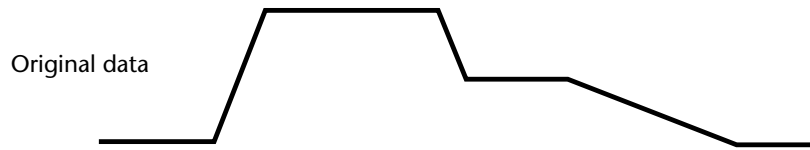

These are the original, or previously recorded level changes.

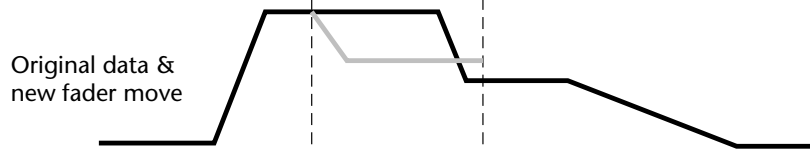

These are the original level changes with the new fader move shown in gray. The two vertical lines indicate the duration of the fader edit.

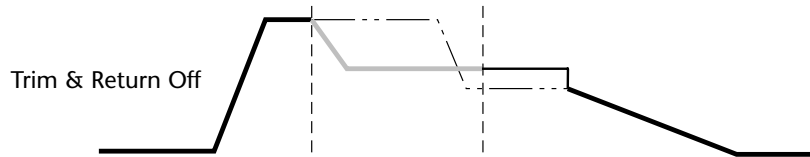

With the fader edit complete, the level changes look like this. The level is lowered and remains the same until the next level change in the previously recorded data occurs.

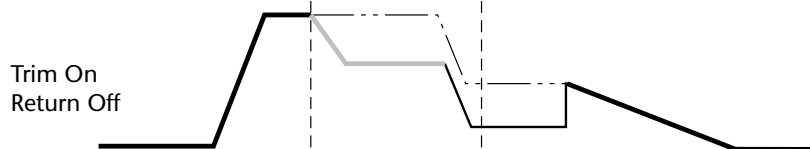

If trim was on, the level would be lowered relative to the number of fader steps (see trim on page 190) and the previously recorded level change occurring within the edit period would still occur.

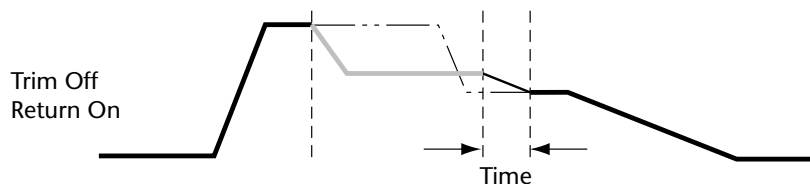

If return was on, the level would be lowered relative to the number of fader steps (see trim on page 190) but then return to the level previously recorded at the end of the fader edit. The TIME parameter determines how long it takes the level to return to the previous value, and affects only the normal channel faders. It's recorded as cross fade data and is listed as XF data on the off-line Event Edit page.

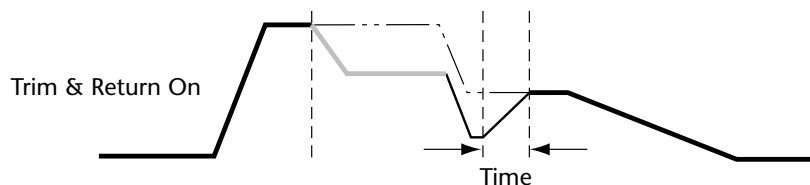

If both trim and return were on, the level would be lowered relative to the number of fader steps (see trim on page 190) and the previously recorded level change occurring within the edit period would still occur. At the end of the edit period, however, the level would return to the level previously recorded, and subsequent level changes would not be affected. The TIME parameter determines how long it takes the level to return to the previous value, and affects only the normal channel faders.

Editing Events Off-line

Events in the current automix can be edited off-line using the Event Edit page (this page cannot be accessed during automix playback or recording).

1. Use the [AUTOMIX] button to locate the Event Edit page.

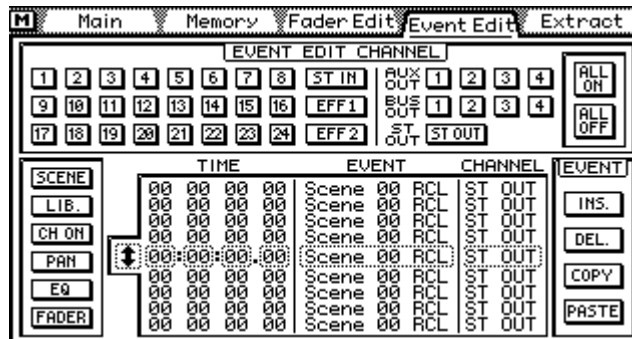

Events are listed chronologically in the event list, which shows the time, event type, and the channel that it applies to.

2. Use the cursor buttons to select an EVENT EDIT CHANNEL switch, and then press the [ENTER] button to activate that channel.

If you are using a mouse, simply click the EVENT EDIT CHANNEL switch.

Events for the selected channel appear in the event list. The EVENT EDIT CHANNEL switches can be used to filter events from the event list. Use the ALL ON and ALL OFF switches to turn on or off all EVENT EDIT CHANNEL switches together.

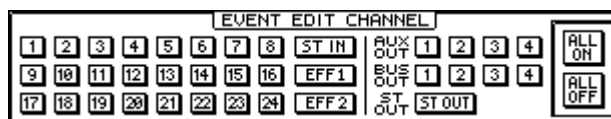

3. Use the cursor buttons to select a parameter type switch, and then press the [ENTER] button to activate it.

If you are using a mouse, simply click a parameter type switch.

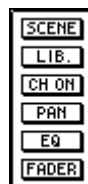

Events containing the selected parameter type appear in the event list. The parameter type switches can be used to filter certain types of events from the list.

Switch	Parameters
SCENE	Mix scene recalls, including transmitted MIDI Program Changes, scene recall safe
LIB.	Channel, EQ, dynamics, and effects library recalls
CH ON	Channel [ON] buttons
PAN	Pan, balance, surround pan
EQ	EQ
FADER	Normal CH faders, cross fades, CH AUX sends, & CH Effect sends

Cross fade events occur when the Return function is used on-line or the Trim function on the Extract page is used for fader editing. Cross fades provide smooth fade ins and fade outs.

4. Use the cursor buttons to select the scroll arrows next to the event list, and the PARAMETER wheel to scroll through the events.

If you are using a mouse, position the mouse cursor over the scroll arrows, press and hold the left mouse button, and then drag the mouse.

5. To edit individual parameters, use the cursor buttons to select the TIME, EVENT, and CHANNEL parameter of the selected event, and the PARAMETER wheel to edit them.

If you are using a mouse, position the mouse cursor over a parameter, press and hold the left mouse button, and then drag the mouse.

When an event's TIME value is changed and the cursor moved to the scroll arrows, events are sorted automatically.

When the time base is set to MIDI Clock, the TIME column shows measure, beat, and MIDI clock. You can specify measures in single steps or in 100-measure steps. Time signature information appears as events. An automix can have up to 12 time signature events.

Time signature (MIDI Clock time base) and MIDI Program Change messages can only be edited using the Event Edit page. These events will not be played back correctly if two or more occur within a single MTC frame or MIDI Clock cycle. MIDI Program Change messages are transmitted from the MIDI OUT and TO HOST. For TO HOST you can select a port from 1 to 7. When the Standard I/F mode is used, however, the port setting is ignored. If two or more events for a channel occur within a single MTC frame or MIDI Clock cycle, only one event can be played correctly.

Events that can be recalled via a mix scene or library program that occur before a mix scene or library program recall, and are in the same timecode frame, have no effect because of the subsequent scene or program recall.

When you record with an automix that has been edited off-line, even if nothing is recorded, the existing data is optimized, and in some cases, events are sorted or invalid events deleted.

6. To insert or delete an event, use the cursor buttons to select an EVENT edit switch, and then press the [ENTER] button to execute the selected function.

If you are using a mouse, simply click an EVENT switch to execute a function.

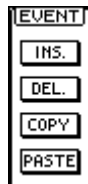

Switch	Function
INS.	Inserts a new event. The new event is assigned the same time value as the preceding event. The time value, event type, and the channel can then be set as required.
DEL.	Deletes the selected event and copies it to the copy/paste buffer.
COPY	Copies the selected event to the copy/paste buffer.
PASTE	Pastes the event from the copy/paste buffer into the event list. The pasted event is assigned the same time value as the preceding event. The time value can be set as required.

MTC Time Base Event List Example

Time	Event	Channel	Description	
--:--:--:--	RCL SAFE	OFF	Ch 1	Channel 1 scene recall safe set to OFF (normally in list)
--:--:--:--	RCL SAFE	OFF	Ch 2	Channel 2 scene recall safe set to OFF (normally in list)
:	:	:	:	
--:--:--:--	RCL SAFE	ON	MasST	Stereo output scene recall safe set to ON (normally in list)
--:--:--:--	SAFE ENA.	DIS		Scene recall safe disable, enable
--:--:--:--	SAFE MODE	ALL		Scane recall all safe or only fader safe
--:--:--:--	SCENE RCL	0		First mix scene (0) recalled (normally in list). Can be set to OFF
Dynamic automix data starts here				
00:00:10.00	FAD CH	0.2	Ch 1	Channel 1 fader level set to 0.2 dB
00:00:10.04	FAD EFF1	-0.5	Ch18	Channel 18 effects 1 send fader level set to -0.5dB
00:00:10.08	FAD AUX4	1.2	Rtn1	Effects return channel 1 aux 4 send fader level set to 1.2 dB
00:00:10.20	CH ON/OFF	OFF	Bus2	Bus 2 ON/OFF set to OFF
00:00:10.21	PAN	L16	Ch 1	Channel 1 pan set to L16
00:00:10.25	BALANCE	C	StIn	Stereo input channel balance set to center
00:00:10.27	SurPAN LR	L16	Ch 1	Channel 1 surround pan left:right set to L16
00:00:11.27	SurPAN FR	R16	Ch 1	Channel 1 surround pan front:rear set to R16
00:00:12.27	EQ ON/OFF	OFF	Ch 1	Channel 1 EQ ON/OFF set to OFF
00:00:12.28	EQ F LOW	4	Ch 1	Channel 1 low EQ frequency set to 4 (see page 196)
00:00:13.10	EQ G L-M	5	Ch 1	Channel 1 low mid EQ gain set to 5 (see page 197)
00:00:13.22	EQ Q H-M	6	Ch 1	Channel 1 high mid EQ set to 6 (see page 197)
00:00:14.04	EQ Q HIGH	7	Ch 1	Channel 1 high EQ Q set to 7 (see page 197)
00:00:14.16	EQ LIB	1	Ch 1	EQ program 1 recalled to channel 1
00:00:14.17	DYNA LIB	1	Ch 1	Dynamics program 1 recalled to channel 1
00:00:14.18	CH LIB	1	Ch 1	Channel program 1 recalled to channel 1
00:00:14.19	RCL SAFE	ON	Ch 1	Channel 1 recall safe set to ON
00:00:14.20	SCENE RCL	10		Mix scene 10 recalled
00:00:14.21	EFF1 LIB	1		Effects program 1 recalled to Effect 1
00:00:14.22	XF t=3.0s	0.2	Ch 1	Channel 1 cross fade of 3.0 seconds with final level of 0.2 dB
00:00:14.22	PGM MIDI	3	1	Program Change 3 message transmitted on MIDI Channel 1
00:00:14.22	PGM HOST1	4	2	Program Change 4 message transmitted on TO HOST port 1

MIDI Clock Time Base Event List Example

Time	Event	Channel	Description	
--:--:--:--	RCL SAFE	OFF	Ch 1	Channel 1 scene recall safe set to OFF (normally in list)
--:--:--:--	RCL SAFE	OFF	Ch 2	Channel 2 scene recall safe set to OFF (normally in list)
:	:	:	:	
--:--:--:--	RCL SAFE	ON	MasST	Stereo output scene recall safe set to ON (normally in list)
--:~:~:~:~	SCENE RCL	0		First mix scene (0) recalled (normally in list). Can be set to OFF
----.---:--	SIG.INI	4/4		Initial time signature set to 4/4 (normally in list)
0017.---:--	SIG. 1	3/4		Time signature set to 3/4 (normally in list). Measure can also be set
:	:	:	:	
----.---:--	SIG.12	----		Time signature change events with no value specified look like this
Dynamic automix data starts here				
0001.01.01	FAD CH	0	Ch 1	Channel 1 fader level set to 0dB
0001.02.01	CH ON/OFF	OFF	Bus2	Bus 2 ON/OFF set to OFF
Same as MTC Time Base Event List Example on page 195				

EQ Frequency Event Value Table

Value	Frequency
0	21 Hz
1	22 Hz
2	23 Hz
3	24 Hz
4	25 Hz
5	26 Hz
6	27 Hz
7	31 Hz
8	33 Hz
9	35 Hz
10	37 Hz
11	39 Hz
12	42 Hz
13	44 Hz
14	47 Hz
15	50 Hz
16	53 Hz
17	56 Hz
18	59 Hz
19	63 Hz
20	66 Hz
21	70 Hz
22	74 Hz
23	79 Hz
24	83 Hz
25	88 Hz
26	94 Hz
27	99 Hz
28	105 Hz
29	111 Hz

Value	Frequency
30	118 Hz
31	125 Hz
32	132 Hz
33	140 Hz
34	149 Hz
35	157 Hz
36	167 Hz
37	177 Hz
38	187 Hz
39	198 Hz
40	210 Hz
41	228 Hz
42	236 Hz
43	250 Hz
44	265 Hz
45	281 Hz
46	297 Hz
47	315 Hz
48	334 Hz
49	354 Hz
50	375 Hz
51	397 Hz
52	420 Hz
53	445 Hz
54	472 Hz
55	500 Hz
56	530 Hz
57	561 Hz
58	595 Hz
59	630 Hz

Value	Frequency
60	667 Hz
61	707 Hz
62	749 Hz
63	794 Hz
64	841 Hz
65	891 Hz
66	944 Hz
67	1.00 kHz
68	1.05 kHz
69	1.12 kHz
70	1.18 kHz
71	1.26 kHz
72	1.33 kHz
73	1.41 kHz
74	1.49 kHz
75	1.58 kHz
76	1.68 kHz
77	1.78 kHz
78	1.88 kHz
79	2.00 kHz
80	2.11 kHz
81	2.24 kHz
82	2.37 kHz
83	2.52 kHz
84	2.67 kHz
85	2.82 kHz
86	2.99 kHz
87	3.17 kHz
88	3.36 kHz
89	3.56 kHz

Value	Frequency
90	3.77 kHz
91	4.00 kHz
92	4.23 kHz
93	4.49 kHz
94	4.75 kHz
95	5.04 kHz
96	5.33 kHz
97	5.65 kHz
98	5.99 kHz
99	6.35 kHz
100	6.72 kHz
101	7.12 kHz
102	7.55 kHz
103	8.00 kHz
104	8.47 kHz
105	8.98 kHz
106	9.51 kHz
107	10.0 kHz
108	10.6 kHz
109	11.3 kHz
110	11.9 kHz
111	12.6 kHz
112	13.4 kHz
113	14.2 kHz
114	15.1 kHz
115	16.0 kHz
116	16.9 kHz
117	17.9 kHz
118	19.0 kHz
119	20.1 kHz

EQ Gain Event Value Table

Value	Gain
0	-18.0 dB
1	-17.5 dB
2	-17.0 dB
3	-16.5 dB
4	-16.0 dB
5	-15.5 dB
6	-15.0 dB
7	-14.5 dB
8	-14.0 dB
9	-13.5 dB
10	-13.0 dB
11	-12.5 dB
12	-12.0 dB
13	-11.5 dB
14	-11.0 dB
15	-10.5 dB
16	-10.0 dB
17	-9.5 dB
18	-9.0 dB

Value	Gain
19	-8.5 dB
20	-8.0 dB
21	-7.5 dB
22	-7.0 dB
23	-6.5 dB
24	-6.0 dB
25	-5.5 dB
26	-5.0 dB
27	-4.5 dB
28	-4.0 dB
29	-3.5 dB
30	-3.0 dB
31	-2.5 dB
32	-2.0 dB
33	-1.5 dB
34	-1.0 dB
35	-0.5 dB
36	0.0 dB
37	+0.5 dB

Value	Gain
38	+1.0 dB
39	+1.5 dB
40	+2.0 dB
41	+2.5 dB
42	+3.0 dB
43	+3.5 dB
44	+4.0 dB
45	+4.5 dB
46	+5.0 dB
47	+5.5 dB
48	+6.0 dB
49	+6.5 dB
50	+7.0 dB
51	+7.5 dB
52	+8.0 dB
53	+8.5 dB
54	+9.0 dB
55	+9.5 dB
56	+10.0 dB

Value	Gain
57	+10.5 dB
58	+11.0 dB
59	+11.5 dB
60	+12.0 dB
61	+12.5 dB
62	+13.0 dB
63	+13.5 dB
64	+14.0 dB
65	+14.5 dB
66	+15.0 dB
67	+15.5 dB
68	+16.0 dB
69	+16.5 dB
70	+17.0 dB
71	+17.5 dB
72	+18.0 dB

EQ HPF & LPF On/Off Value Table

Value	On/Off
0-35	OFF

Value	On/Off
36-72	ON

When Q is set to 43 or 44 (i.e., LPF or HPF), the Gain controls are used to turn the LPF and HPF filters on and off.

EQ Q Event Value Table

Value	Q
0	10.0
1	9.0
2	8.0
3	7.0
4	6.3
5	5.6
6	5.0
7	4.5
8	4.0
9	3.5
10	3.2
11	2.8

Value	Q
12	2.5
13	2.2
14	2.0
15	1.8
16	1.6
17	1.4
18	1.2
19	1.1
20	1.0
21	0.90
22	0.80
23	0.70

Value	Q
24	0.63
25	0.55
26	0.50
27	0.45
28	0.40
29	0.35
30	0.32
31	0.28
32	0.25
33	0.22
34	0.20
35	0.18

Value	Q
36	0.16
37	0.14
38	0.12
39	0.11
40	0.10
41	Low Shelving
42	High Shelving
43	LPF
44	HPF

Extracting Events

Events in the current automix can be deleted or moved and fader levels can be trimmed by a specified amount using the Extract page (this page cannot be accessed during automix playback or recording).

1. Use the [AUTOMIX] button to locate the Extract page.

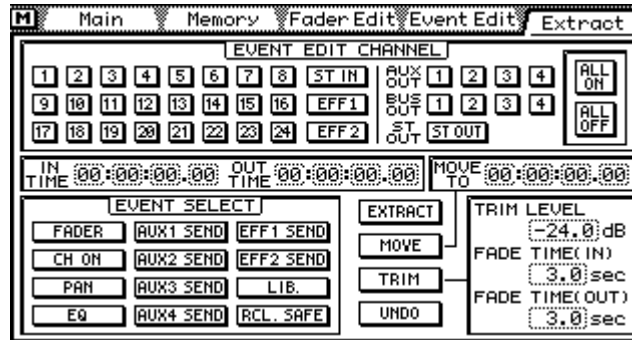

2. Use the cursor buttons to select an EVENT EDIT CHANNEL switch, and then press the [ENTER] button to activate that channel.

If you are using a mouse, simply click the EVENT EDIT CHANNEL switch.

The EVENT EDIT CHANNEL switches are used to select the channel whose event you want to edit. Use the ALL ON and ALL OFF switches to turn on or off all EVENT EDIT CHANNEL switches together.

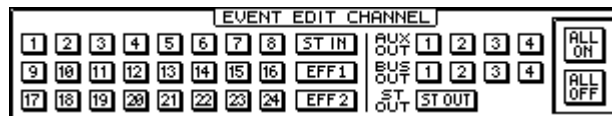

3. Use the cursor buttons to select the IN TIME, OUT TIME, and MOVE TO time values, and the PARAMETER wheel to set them.

If you are using a mouse, position the mouse cursor over the a time value, press and hold the left mouse button, and then drag the mouse.



Events between the IN and OUT times are extracted, moved, or trimmed. The MOVE TO time is used to specify the destination when events are moved.

When the time base is set to MIDI Clock, the IN and OUT times are displayed in measures, beats, and MIDI clocks, as shown below, and you can specify measures in single steps or in 100-measure steps.



If the MOVE TO or OUT TIME is set to a time before the specified offset, the OUT TIME set to a point before the IN TIME, or the IN TIME or OUT TIME set to a point after the last recorded event, the selected function is not executed. Likewise, if the values specified exceed the maximum recording time, the selected function is not executed.

4. Use the cursor buttons to select an EVENT SELECT switch, and then press the [ENTER] button to activate it.

If you are using a mouse, simply click an EVENT SELECT switch.

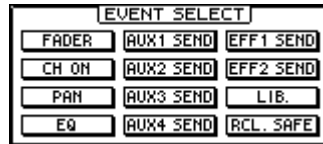

The EVENT SELECT switches are used to select the type of event to be extracted, moved, or trimmed.

Switch	Parameters
FADER	Normal CH faders, cross fades
CH ON	Channel [ON] buttons
PAN	Pan, balance, surround pan
EQ	EQ
AUX 1 SEND	Aux 1 send faders
AUX 2 SEND	Aux 2 send faders
AUX 3 SEND	Aux 3 send faders
AUX 4 SEND	Aux 4 send faders
EFF 1 SEND	Effect 1 send faders
EFF 2 SEND	Effect 2 send faders
LIB.	Channel, EQ, and dynamics library recalls.
RCL. SAFE	Mix scene recall safe channel settings (this does not include the initial recall safe settings)

- If you are using the trim function, set the trim level and fade in and fade out parameters.

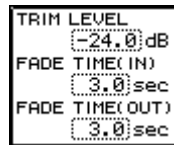

TRIM LEVEL—This is used to set how much levels are trimmed. Levels can be trimmed from -24.0 dB to +24.0 dB in 0.5 dB steps.

FADE TIME (IN)—This determines how long it takes to reach the specified trim level after the IN TIME. It can be set to OFF or from 0.0 to 3.0 seconds in 0.2 second steps.

FADE TIME (OUT)—This determines how long it takes to return to the previous level after the OUT TIME. It can be set to OFF or from 0.0 to 3.0 seconds in 0.2 second steps.

When the TIME is set to OFF, cross fade data is not recorded, and the existing data remains in effect until a change occurs. As the IN TIME determines the start of the fade in and the TIME OUT determines the start of the fade out, be sure to allow enough time for the fade in or fade out to complete.

- Use the cursor buttons to select a function switch, and then press the [ENTER] button to execute the selected function.

If you are using a mouse, simply click a function switch to execute a function.

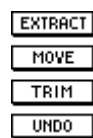

Switch	Function
EXTRACT	Events between the IN and OUT points are deleted.
MOVE	Events between the IN and OUT points are move to the MOVE TO point. Events of the same type at the destination are deleted.
TRIM	Fader events between the IN and OUT points are trimmed by the amount specified.
UNDO	Undo the extract, move, or trim operation. Undo must be turned on to use this function. See Undoing Automix Operations on page 200 for more information.

Events can be moved only when the Undo function is enabled and there is sufficient memory. When events are moved, events of the same type at the specified destination

are overwritten. The trim fade times apply only to normal channel faders. The Trim and Extract functions require at least 1K of free memory. Mix scene recalls, effects library recalls, initial safe channel settings, time signature settings, and transmitted MIDI Program Changes cannot be edited on the Extract page. Use the Event Edit page to edit these events. See *Editing Events Off-line* on page 193 for more information.

Automix data in memory is compressed. So even when events are deleted, the amount of free memory may not, in some cases, increase.

Undoing Automix Operations

The automix undo function allows you to revert to the previous automix after making changes that you do not want to keep. Executing the undo function swaps the contents of the undo buffer and current automix. The undo function can be turned on and off, and the contents of the undo buffer can be cleared at anytime, freeing up memory for automix recording. Normally it's best to work with the Undo function enabled. If you're working on a long automix and automix memory is getting low, however, it should be disabled. Seeing as you cannot undo automix edits with the Undo function disabled, we recommend that you back up your automix data to an external MIDI device via MIDI Bulk Dump. See *Bulk Dump* on page 242 for more information.



The undo controls shown here are available on the Main and Memory pages. Operation is identical on both pages. The main undo switch, however, is available on the Main and Extract pages.

Before automix changes can be undone, the undo function must be turned on (i.e., enabled) before making any changes. Otherwise, there won't be any data in the undo buffer to recall.

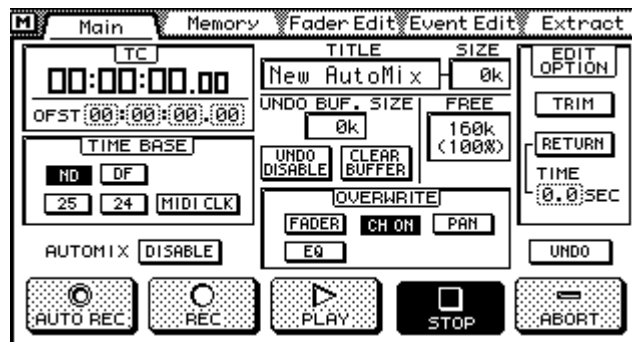
1. Use the [AUTOMIX] button to locate the Main page.



2. Use the cursor buttons to select the UNDO ENABLE switch, and then press the [ENTER] button.
If you are using a mouse, simply click the UNDO ENABLE switch.
A confirmation dialog box appears.
3. Use the cursor buttons to select OK, and then press the [ENTER] button.
If you are using a mouse, simply click OK.

 Undo off (disabled)
 Undo on (enabled)

The previous contents of the current automix are copied to the undo buffer when

- A new automix is created (see *Creating a New Automix* on page 180)
- An automix is recalled (see *Recalling Automixes* on page 203)

- Fader moves are edited “on the fly” (see *Editing Fader Moves On-the-fly* on page 190)
- Automix events are extracted (see *Extracting Events* on page 198)

UNDO BUF. SIZE The UNDO BUF. SIZE window displays the amount of memory being used by the undo buffer.

0k

4. To undo changes to the automix, use the cursor buttons to select the UNDO switch, which is located above the ABORT switch, and then press the [ENTER] button.



If you are using a mouse, simply click the UNDO switch.

A confirmation dialog box appears.

5. Use the cursor buttons to select OK, and then press the [ENTER] button. If you are using a mouse, simply click OK.

The contents of the undo buffer are copied to the current automix.

Clearing the Undo Buffer

The contents of the undo buffer can be cleared at anytime. This can be used to free up memory for further recording, or simply to clear the undo buffer contents that are no longer required.

1. Use the [AUTOMIX] button to locate the Main page.

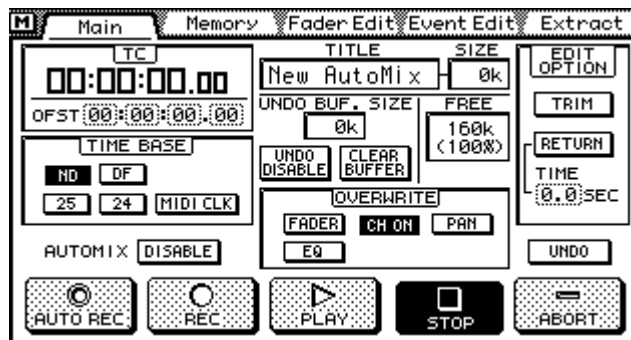

2. Use the cursor buttons to select the CLEAR BUFFER switch, and then press the [ENTER] button.

If you are using a mouse, simply click the CLEAR BUFFER switch.

A confirmation dialog box appears.

3. Use the cursor buttons to select OK, and then press the [ENTER] button. If you are using a mouse, simply click OK.

The contents of the undo buffer are cleared, and the UNDO BUF. SIZE window indicates 0K.

Storing Automixes

Automixes are stored on the Memory page. Up to four automixes can be stored. Automixes and the current automix can be backed up to an external MIDI device, such as a MIDI data file, using MIDI Bulk Dump. See Bulk Dump on page 242 for more information.

1. Use the [AUTOMIX] button to locate the Memory page.

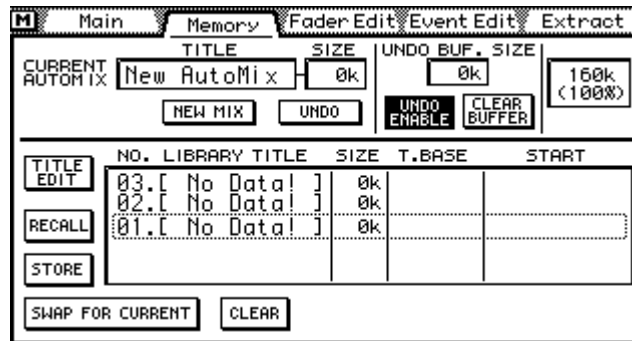

2. Use the PARAMETER wheel to scroll through the list of automixes.
If you are using a mouse, position the mouse cursor over the parameter box, press and hold the left mouse button, and then drag the mouse.
The number, title, size, time base, and start time for each automix is displayed. Automix memories that do not contain data have the title No Data!
3. Use the cursor button to select the STORE switch, and then press the [ENTER] button.
If you are using a mouse, simply click the STORE switch.
The Title Edit dialog box appears.
4. Enter a title for the automix.
See Title Edit Dialog Box on page 33 for more information.
5. Press OK on the Title Edit dialog box.
The contents of the current automix are stored to the selected automix memory.

Recalling Automixes

Automixes are recalled on the Memory page. You can recall any one of the four automixes. When an automix is recalled, the contents of the current automix are replaced by the contents of the automix being recalled. You may want to store the current automix before recalling an automix. See Storing Automixes on page 202 for more information.

1. Use the [AUTOMIX] button to locate the Memory page.

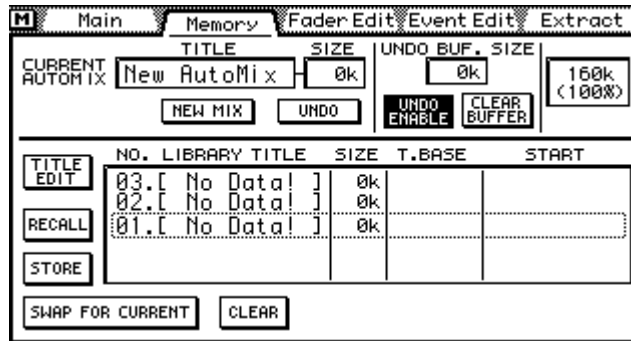

2. Use the PARAMETER wheel to scroll through the list of automixes.

If you are using a mouse, position the mouse cursor over the parameter box, press and hold the left mouse button, and then drag the mouse.

The number, title, size, time base, and start time for each automix is displayed. Automix memories that do not contain data have the title No Data!

3. Use the cursor button to select the RECALL switch, and then press the [ENTER] button.

If you are using a mouse, simply click the RECALL switch.

The contents of the selected automix are recalled and become the current automix.

When an automix is recalled, and the undo function is on, the previous current automix is copied to the undo buffer. If there's not enough memory available to recall an automix and have the current automix copied to the undo buffer, the current automix and automix memory can simply be swapped. See Swapping the Current Automix on page 204 for more information.

Swapping the Current Automix

When an automix is recalled, and the undo function is on, the previous current automix is copied to the undo buffer. If there's not enough memory available to recall an automix and have the current automix copied to the undo buffer, the current automix and automix memory can simply be swapped. Swap can also be used when you attempt to store or recall an automix that is too large for the available memory.

1. Use the [AUTOMIX] button to locate the Memory page.

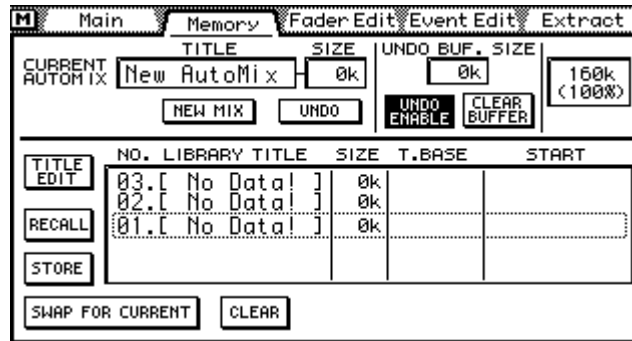

2. Use the PARAMETER wheel to scroll through the list of automixes.
If you are using a mouse, position the mouse cursor over the parameter box, press and hold the left mouse button, and then drag the mouse.
The number, title, size, time base, and start time for each automix is displayed. Automix memories that do not contain data have the title No Data!
3. Use the cursor button to select the SWAP FOR CURRENT switch.
4. Press the [ENTER] button.
If you are using a mouse, simply click the SWAP FOR CURRENT switch.
A confirmation dialog box appears.
5. Use the cursor buttons to select OK, and then press the [ENTER] button.
If you are using a mouse, simply click OK.
The current automix and automix memory are swapped without affecting the undo buffer.

Editing Automix Titles

Automix titles can be edited at anytime. You don't have to recall an automix to edit its title. Only automixes that contain data can have their titles edited. Title editing is performed on the Memory page shown below.

1. Use the [AUTOMIX] button to locate the Memory page.

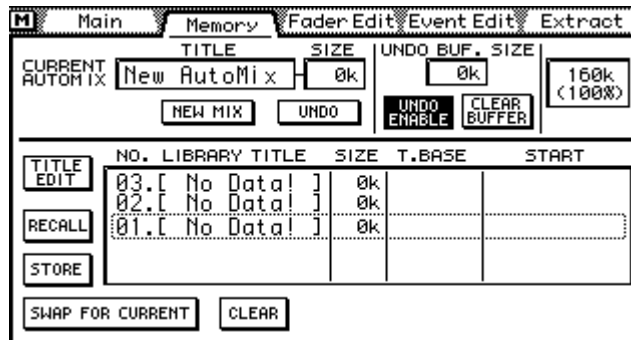

2. Select the automix using the PARAMETER wheel or mouse.
If you are using a mouse, position the mouse cursor over the parameter box, press and hold the left mouse button, and then drag the mouse.
3. Use the cursor buttons to select the TITLE EDIT switch, and then press the [ENTER] button.
If you are using a mouse, simply click the TITLE EDIT switch.
The Title Edit dialog box appears.
4. Edit the automix title.
See Title Edit Dialog Box on page 33 for more information.
5. When you've finished, press OK on the Title Edit dialog box.

Clearing Automix Memories

The contents of the four automix memories can be cleared individually. This can be used to free up memory for further recording, or simply to clear automixes that are no longer required. It can also be used to delete automixes that have been backed up using MIDI Bulk Dump. See Bulk Dump on page 242 for more information. Automix memories are cleared on the Memory page. You don't have to recall an automix to clear it.

1. Use the [AUTOMIX] button to locate the Memory page.

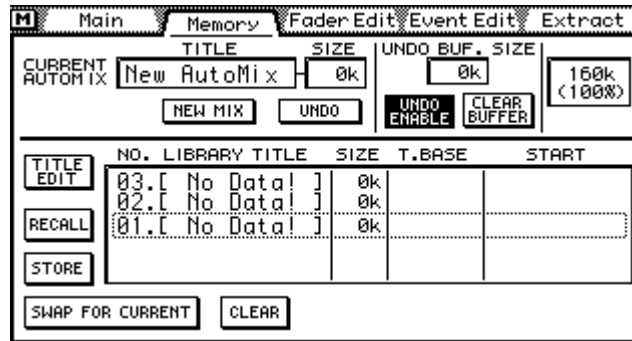

2. Select the automix using the PARAMETER wheel or mouse.
If you are using a mouse, position the mouse cursor over the parameter box, press and hold the left mouse button, and then drag the mouse.
3. Use the cursor buttons to select the CLEAR switch.
4. Press the [ENTER] button.
If you are using a mouse, simply click the CLEAR switch.
A confirmation dialog box appears.
5. Press OK to confirm.
The selected automix memory is cleared, and the title, size, time base, and start values are reset.

Other Functions

17

In this chapter...

User Define Buttons	208
Using the Onboard Oscillator	212
03D Preferences	213
Checking the Battery	214
Initializing the 03D	214
Calibrating the Faders	214

User Define Buttons

The USER DEFINE buttons are user-programmable buttons that can be configured to send specific MIDI or MMC (MIDI Machine Control) commands when pressed. They can also be used to recall frequently used mix scenes or effects programs, adjust mix settings of the selected channel, or control the Automix function.

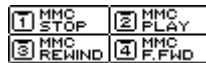
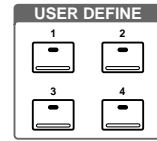

The functions of the USER DEFINE buttons are continuously shown by the four switches at the top-right of the display, as shown here.

Any one of 31 functions can be assigned to a USER DEFINE button. Four banks allow you to configure four individual USER DEFINE button configurations. The USER DEFINE buttons are configured on the User Def. page.

1. Use the [UTILITY] button to locate the User Def. page shown below.

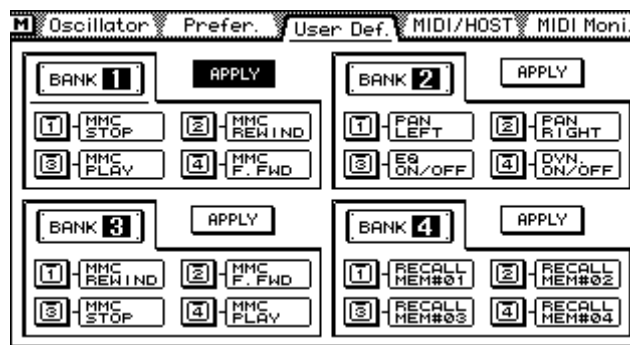

2. Use the cursor buttons to select a button in a bank.
3. Press the [ENTER] button.

If you are using a mouse, simply click a button.

The FUNCTION DEFINE dialog box shown below appears.

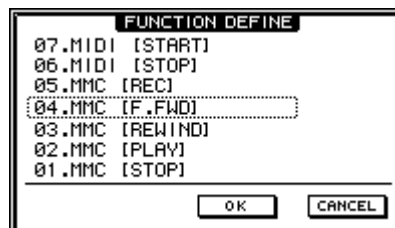

4. Use the PARAMETER wheel to scroll through the available functions. If you are using a mouse, position the mouse cursor over the parameter box, press and hold the left mouse button, and then drag the mouse.
5. Use the cursor buttons to select the OK switch, and then press the [ENTER] button. If you are using a mouse, simply click the OK switch.
6. To make a bank active, select its APPLY switch, and then press the [ENTER] button.

If you are using a mouse, simply click an APPLY switch.

The following functions can be assigned to the USER DEFINE buttons.

MMC Commands

#	Function	Description
00	----- (No assign)	No function
01	MMC [STOP]	Transmit MMC Stop command (F0 7F nn 06 01 F7)
02	MMC [PLAY]	Transmit MMC Deferred Play command (F0 7F nn 06 03 F7)
03	MMC [REWIND]	Transmit MMC Rewind command (F0 7F nn 06 05 F7)
04	MMC [F. FWD]	Transmit MMC Fast Forward command (F0 7F nn 06 04 F7)
05	MMC [REC]	Transmit MMC Record Strobe command (F0 7F nn 06 06 F7)

The “nn” part of each MMC command is the device number of the receiving machine. This is set on the MIDI/HOST page. See MIDI/HOST Setup on page 233 for more information.

MIDI Real-time Messages

#	Function	Description
06	MIDI [STOP]	Transmit MIDI Stop message (FCH)
07	MIDI [START]	Transmit MIDI Start message (FAH)
08	MIDI [CONTINUE]	Transmit MIDI Continue message (FBH)

Scene Memories & Libraries

#	Function	Description
09	Scene +1 Recall	Recall mix scene current+1
10	Scene -1 Recall	Recall mix scene current-1
11	Scene mem. Recall (No.xx)	Recall the specified mix scene
12	Eff1 lib.+1 Recall	Recall effects program current+1 to Effect 1
13	Eff1 lib.-1 Recall	Recall effects program current-1 to Effect 1
14	Eff1 lib. Recall (No.xx)	Recall the specified program to Effect 1
15	Eff2 lib.+1 Recall	Recall effects program current+1 to Effect 2
16	Eff2 lib.-1 Recall	Recall effects program current-1 to Effect 2
17	Eff2 lib. Recall (No.xx)	Recall the specified program to Effect 2

If the current mix scene or effects program is the last in the series, nothing is recalled when a current+1 function is used. Similarly, if the current mix scene or effects program is the first in the series, nothing is recalled when a current-1 function is used.

If the specified mix scene or effects program contains no data, the next scene or program that contains data is recalled.

Automix

#	Function	Description
18	Automix [REC]	Same as REC switch on Main automix page
19	Automix [PLAY]	Same as PLAY switch on Main automix page
20	Automix [STOP]	Same as STOP switch on Main automix page
21	Automix [ABORT]	Same as ABORT switch on Main automix page

Channel Controls

#	Function	Description
22	CH Delay on/off	Turn the selected channel's delay on or off
23	EQ on/off	Turn the selected channel's EQ on or off
24	Dynamics on/off	Turn the selected channel's dynamics processor on or off
25	PAN Left	Pan selected channel one step to the left
26	PAN Right	Pan selected channel one step to the right
27	PAN Front	Pan selected channel one step to the front (surround pan)
28	PAN Rear	Pan selected channel one step to the rear (surround pan)

For the stereo input channel, the effects returns channels, and the stereo output, PAN LEFT and PAN RIGHT set the balance, not pan.

If a pair of USER DEFINE buttons are set to PAN LEFT and PAN RIGHT, or PAN FRONT and PAN REAR, pressing those buttons together sets the pan or balance to center.

Others

#	Function	Description
29	Peak Hold on/off	Turn the meter Peak Hold function on or off
30	Oscillator on/off	Turn the oscillator on or off

User Define Button Indicators

Each USER DEFINE button has a LED indicator built-in. Operation of these indicators depends on the selected function and is explained in the following table.

Function	Type	Indicator Operation
1 to 17, 21	Simple trigger	Lights up momentarily when button is pressed.
19, 20, 22, 23, 24, 29, 30	ON/OFF operation	Lights up when the specified function is on.
18	Automix REC	Flashes in Rec Ready mode. Lights up continuously during recording.
25 to 28	PAN	Lights up when the selected channel's pan control is at center or in the direction of the specified function. For example, the indicator of a button set to PAN LEFT lights up when the pan control is set anywhere from L16 to center.

When a pair of USER DEFINE buttons are set to PAN LEFT and PAN RIGHT, or PAN FRONT and PAN REAR, the indicators make it easy to check the pan position of the

selected channel. In the following examples, the PAN LEFT and PAN RIGHT functions are assigned to USER DEFINE buttons [1] and [2].

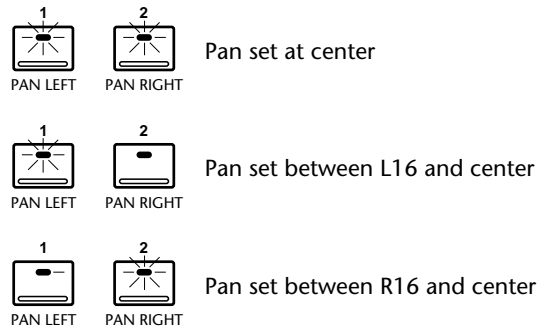

Using the Onboard Oscillator

The 03D features a useful, onboard audio oscillator, which can be assigned to the bus outputs, aux sends, stereo output, and onboard effects. It can be used for calibration or diagnostic purposes. Assigning a burst noise waveform to the onboard effects processors, for example, is a convenient way to audition reverb settings.

1. Use the [UTILITY] button to locate the Oscillator page shown below.

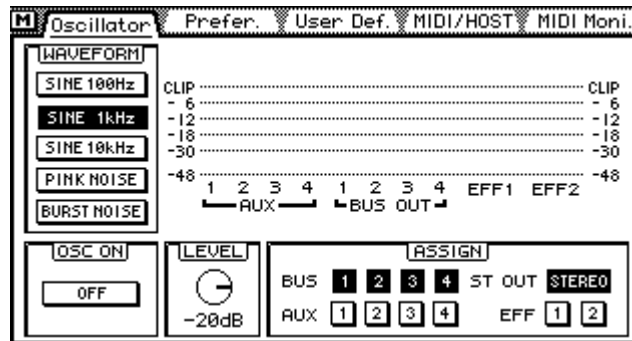

2. Use the cursor button to select parameters and the [ENTER] button to turn them on or off. The PARAMETER wheel can be used to adjust the LEVEL parameter.

WAVEFORM—These switches are used to select the type of waveform generated by the oscillator: SINE 100Hz, SINE 1kHz, SINE 10kHz, PINK NOISE, or BURST NOISE, which consists of 200 ms noise pulses at four second intervals.

OSC ON—This switch is used to turn the oscillator on and off.

Note: To prevent any sudden tone burst surprises in your monitors or headphones, set the oscillator level, stereo output, aux sends, bus outs, or effects returns to a minimal level.

LEVEL—This control is used to adjust the level of the signal generated by the oscillator from 0 dB to -96 dB. This control can be adjusted using the PARAMETER wheel regardless of the cursor position.

ASSIGN—These switches are used to assign the oscillator signal to the: buses, aux sends, stereo output, and onboard effects. When the oscillator is assigned to a bus, the oscillator signal has priority and other signals routed to that bus are muted.

The oscillator remains on even when other display pages are selected. When the 03D is turned on, however, the oscillator is always set to off. Buses that are receiving the oscillator signal cannot receive other signals.

The oscillator signal fed to the Aux buses is delayed by two samples.

03D Preferences

Various 03D preferences can be set on the Prefer. page shown below.

1. Use the [UTILITY] button to locate the Prefer. page shown below.

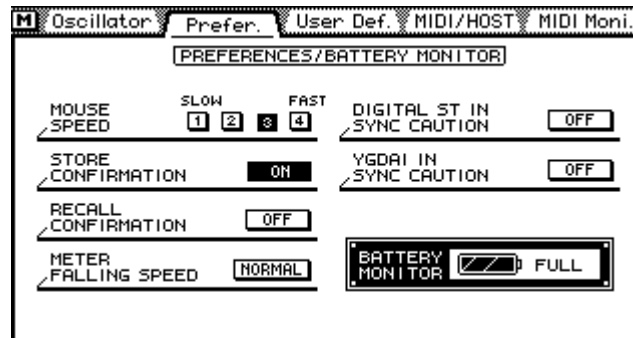

2. Use the cursor buttons to select the parameters and the [ENTER] button to activate them.

The preferences are explained below.

MOUSE SPEED

The mouse speed can be set to one of four speeds. The speed you choose will depend on your personal preference and the amount of physical space available where your mouse is located. Faster speeds allow you to navigate the display quickly with relatively small mouse movements.

STORE CONFIRMATION

When this preference is set to ON, the Title Edit dialog box, which also functions as a confirmation, appears whenever a mix scene or library program is stored. This is useful for preventing mix scenes and library programs from being stored accidentally.

RECALL CONFIRMATION

When this preference is set to ON, the 03D display a confirmation dialog box whenever a mix scene or library program is recalled. This is useful for preventing mix scenes and library programs from being recalled accidentally.

METER FALLING SPEED

The speed at which the level meters fall can be set to one of two speeds: NORMAL or FAST. The initial setting is NORMAL.

DIGITAL ST IN SYNC CAUTION

When this preference is ON, a warning message appears when the DIGITAL STEREO IN signal is not synchronized to the master wordclock source. The initial setting is ON.

YGDAI IN SYNC CAUTION

When this preference is ON, a warning message appears when a YGDAI input signal is not synchronized to the master wordclock source. The initial setting is ON.

Checking the Battery

The 03D uses a long-life battery to maintain its internal memories. The battery should last for up to five years. You can check its condition on the Prefer. page.

1. Use the [UTILITY] button to locate the Prefer. page shown below.

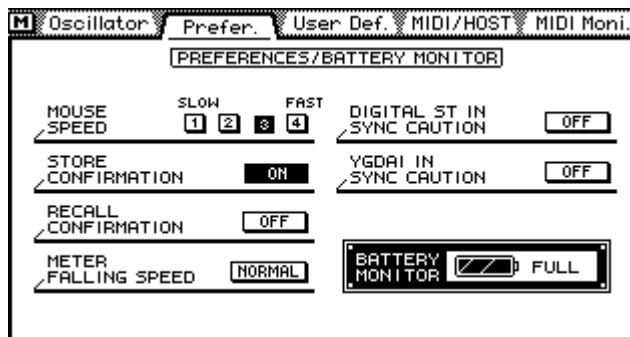

If the battery monitor indicates that the battery is low, contact your Yamaha dealer about having the battery changed. Do not attempt to change the battery yourself.

Note: Failure to change a low battery may result in data loss.

Initializing the 03D

Initialization allows you to reset 03D settings, scene memories, and libraries to their initial values (i.e., the factory settings).

To reset just the mix settings, recall mix scene 00. See Scene Memory 00 on page 165 for more information.

1. Turn off the 03D.
2. While holding down the [STORE] button, turn on the 03D.

A dialog box appears with the following three options. The dialog box appears for about 7 or 8 seconds, so you must make your choice within that time.

 1. Clear Edit Buffer and Setup Memory.
 2. Clear all memories and reset the 03D to its initial settings.
 3. Cancel this dialog box.
3. Release the [STORE] button and select an option.

Calibrating the Faders

If the 03D is not used for a long time, is moved to a new location, or fader movements have been obstructed, the faders may need calibrating. The calibration process calculates the torque required by each fader motor to drive its fader accurately and smoothly.

1. To calibrate the faders, turn off the 03D.
2. While holding down the [ENTER] button, turn on the 03D.

The fader calibration process starts. When the faders return to their original positions, calibration is complete.

Digital I/O

18

In this chapter...

Wordclock Setup	216
Digital Stereo Out	219
Output Dither	220
Digital Stereo In	221
Digital Input Monitor	222
YGDAI Cards	223
Cascading the 03D	227

Wordclock Setup

About Wordclocks

When several digital audio devices are configured in a system, it is essential that they are all synchronized to a single wordclock source. This is not SMPTE or MIDI timecode synchronization. Wordclock synchronization refers to the synchronization of the digital audio processing circuits inside each digital audio device. Typically, one digital audio device acts as wordclock master and other devices work as wordclock slaves. The wordclock frequency is the same as the chosen sampling rate.

Even though some systems appear to work okay with several digital audio devices not sharing a common wordclock (i.e., all devices set to their own internal wordclock), digital audio data is not processed correctly. In some systems this problem will be very audible. In others it may cause subtle distortion. Be aware of this.

In a system where all devices share a common wordclock, it is important that all devices be turned on even when not all of them are being used. Turn on the wordclock master first, and then the slaves. When shutting down the system, turn off the slaves first, and then the master. Before starting a recording session it's a good idea to make sure that all wordclock slaves are locked to the master wordclock source. Most devices have front panel indicators to show whether they are locked to an internal or external wordclock.

Selecting a Wordclock Source

With the 03D's internal wordclock generator, industry-standard sampling rates of 44.1 kHz and 48 kHz are available. When the internal wordclock generator is used, the 03D can be used as wordclock master, with other digital devices working as wordclock slaves. Alternatively, the 03D can be used with external wordclock rates of between 32 kHz -6% and 48 kHz $+6\%$. An external wordclock can be sourced from the DIGITAL STEREO IN, BNC WORD CLOCK IN, or a pair of YGDAI digital inputs.

1. Use the [DIO] button to locate the D.in Setup page shown below.

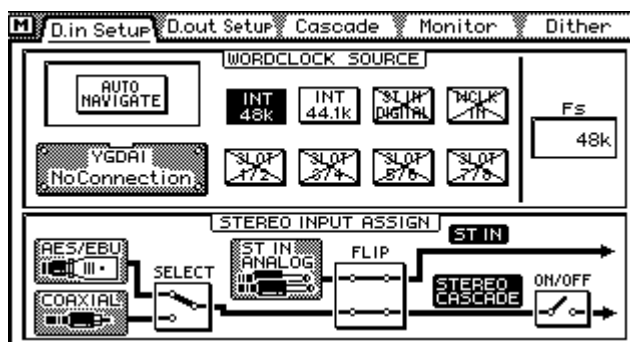

Note: As the wordclock source is being changed, noise may be produced. So before selecting a wordclock source, set the stereo output, aux send, and bus out faders to minimum, turn down your monitor amplifier, and stop all recorders.

2. Use the cursor buttons to select the WORD CLOCK SOURCE options, and the [ENTER] button to set them.

If you are using a mouse, simply click the options.

If the 03D locks correctly to the selected wordclock source, the respective indicator appears highlighted.

AUTO NAVIGATE—This function checks all possible wordclock sources and then displays a dialog box recommending a suitable source. Note, however, that this function is not perfect and in some situations it may not be able to recommend a suitable source. The dialog box shown here appears when this function is selected.



MANUAL—These options allow you to select the wordclock source.



Internal wordclock at 44.1 kHz



Internal wordclock at 48 kHz



External wordclock via the DIGITAL STEREO IN (AES/EBU or Coaxial). The STEREO INPUT ASSIGN FLIP switch on the D.in Setup page must be set so that the AES/EBU or Coaxial signal is assigned to the ST IN.



External wordclock via the BNC WORD CLOCK IN connection



External wordclock via the YGDAI card inputs 1 and 2



External wordclock via the YGDAI card inputs 3 and 4



External wordclock via the YGDAI card inputs 5 and 6



External wordclock via the YGDAI card inputs 7 and 8

The status of these wordclock sources appear as follows.



03D locked to this wordclock source



Usable wordclock present



Wordclock signal present but not synchronized to selected wordclock. If such a signal is connected and the DIGITAL ST IN SYNC CAUTION or YGDAI IN SYNC CAUTION preference is set to ON, a warning message appears. See 03D Preferences on page 213 for more information.



No wordclock signal available.

FS—When the 03D is locked to a wordclock, the sampling rate appears here (48k, 44.1k, or 32k). When it is unlocked, the display shows UNLOCK. If another page is accessed in the unlocked state, UNLOCK appears on that page too.

Wordclock Connections & Termination

For correct operation it is essential that wordclock cabling be terminated correctly. The 03D has a wordclock termination ON/OFF (75Ω) switch on the rear panel. Wordclock is a TTL signal, and IN and OUT connections use BNC connectors. Three wordclock distribution examples are shown below. Note the 75Ω wordclock terminator switch settings.

1. Parallel Distribution with IFU4 Interface Unit

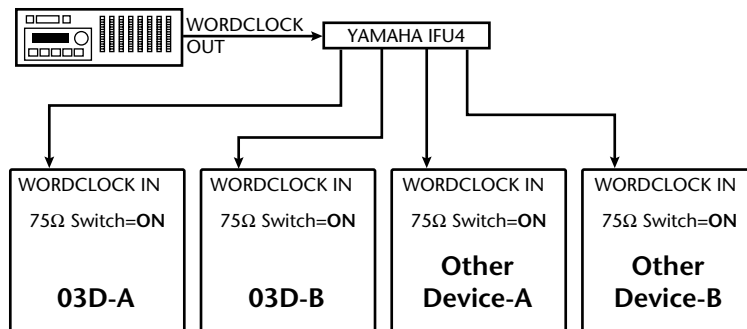

In this example, an Yamaha IFU4 Interface Unit is used to distribute the wordclock signal among devices. All wordclock terminator switches are set to ON.

2. Using BNC T-bar Connectors

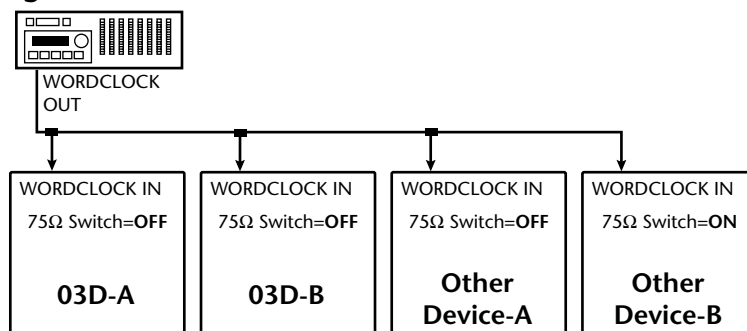

This example is similar to the above except that T-bar connectors are used. In this system, only the last device's wordclock terminator switch is set to ON.

3. Daisy Chain Distribution

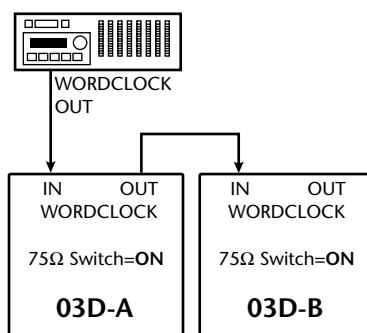

In this example, the wordclock master is a digital multitrack recorder. Both 03D wordclock terminator switches are set to ON. This method of wordclock distribution is not recommended for large systems.

Digital Stereo Out

The 03D features both AES/EBU and COAXIAL-type digital stereo outputs. They output the same digital audio signal but in different formats. The XLR-3-32-type connector outputs AES/EBU format digital audio, while the COAXIAL connector outputs Consumer format digital audio.

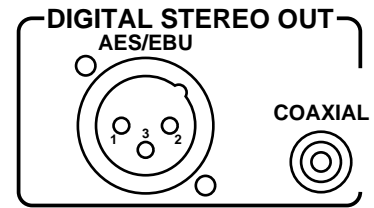

In addition to the stereo output signal, the Stereo bus signals can be selected as the source for these outputs.

1. Use the [DIO] button to locate the D.out Setup page shown below.

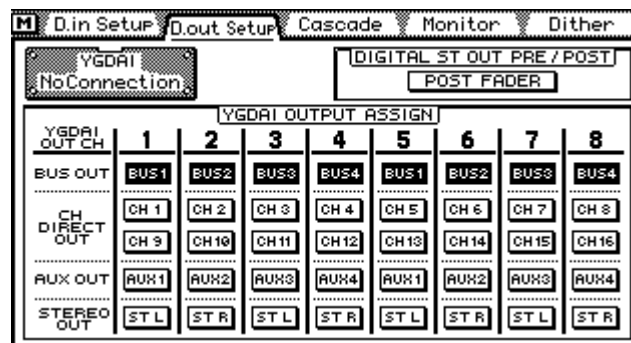

2. Use the cursor buttons to select the DIGITAL ST OUT PRE/POST switch, and the [ENTER] button to select POST FADER or PRE FADER.

POST FADER means that the signal is sourced after the stereo output fader. PRE FADER means that the signal is sourced directly from the Stereo bus.

If you are using a mouse, simply click the DIGITAL ST OUT PRE/POST switch.

The AES/EBU connection outputs digital audio data with a wordlength of 24 bits. The Coaxial connection outputs digital audio data with a wordlength of 20 bits.

Output Dither

The 03D's AES/EBU connection outputs digital audio data with a wordlength of 24 bits. The Coaxial connection outputs digital audio data with a wordlength of 20 bits. When a high-resolution digital audio signal is transferred to a lower-resolution system, some of the least-significant bits (LSB) are ignored by the receiving system. This can make low-level signals sound grainy and step like, similar to the breakup produced by a low-resolution digital reverb processor as a signal fades. The wordlength of a digital audio signal must be shortened to match that supported by the receiving system. The digital dither technique is used to optimize this process. The output of a special pseudorandom number sequence generator is compared with the lowest bit of the shortened data word and those bits below it and is rounded either up or down prior to D/A conversion, thereby optimizing the 03D digital output signals for use with lower-resolution systems. Dither endows digital signals with a noise floor close to the minimum theoretical limit. Whether or not you use dither really depends on your application. If you're unsure, it's best to use dither.

Dither can be set independently for the DIGITAL STEREO OUT and each pair of YGDAI outputs. Set the WORD LENGTH parameters to match the wordlength supported by the digital device connected to the DIGITAL STEREO OUT or YGDAI card. If, for example, you have a 20-bit digital recorder connected to the 03D's DIGITAL STEREO OUT for use as a master recorder, set the wordlength to 20 and turn on dither for the ST OUT DIGITAL.

The ST OUT setting applies to the AES/EBU output and Coaxial output.

1. Use the [DIO] button to locate the Dither page shown below.

OUTPUT DITHER											
	DITHER ON/OFF	WORD LENGTH (BIT)									
ST OUT DIGITAL	OFF	16	17	18	19	20	21	22	23	24	
YGDAI OUT	1-2	OFF	16	17	18	19	20	21	22	23	24
	3-4	OFF	16	17	18	19	20	21	22	23	24
	5-6	OFF	16	17	18	19	20	21	22	23	24
	7-8	OFF	16	17	18	19	20	21	22	23	24

2. Use the cursor buttons to select the dither on/off and wordlength switches, and the [ENTER] button to set them.
If you are using a mouse, simply click the switches.

Digital Stereo In

The 03D features both AES/EBU and COAXIAL-type digital stereo inputs. Only one connection can be used at a time. The XLR-3-31-type connector accepts AES/EBU format digital audio, while the COAXIAL connector accepts Consumer format digital audio. Signals input here can be fed to the stereo input channel or directly to the Stereo bus for stereo cascade operation.

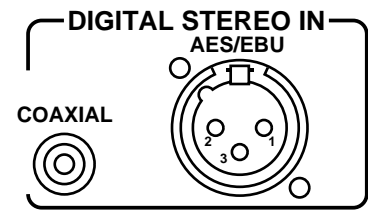

1. Use the [DIO] button to locate the D.in Setup page shown below.

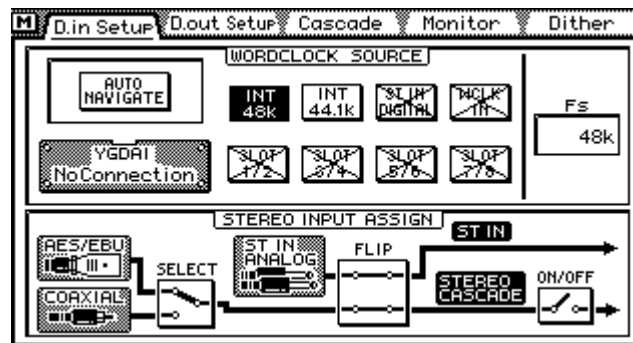

2. Use the cursor buttons to select the STEREO INPUT ASSIGN options, and the [ENTER] button to set them.

If you are using a mouse, simply click the options.

SELECT—This switch is used to select the digital input connection: AES/EBU or COAXIAL. Only one connection can be used at a time.

FLIP—This switch flips the digital stereo input signal to the stereo input channel and the analog stereo input signal to the Stereo bus.

ON/OFF—This switch turns the stereo cascade feed to the Stereo bus on and off. The source of the stereo cascade signal is determined by the SELECT and FLIP options.

Note: When the AES/EBU or Coaxial DIGITAL STEREO IN connection is used, to prevent noise the sending device and 03D must be wordclock synchronized.

Solo

The stereo cascade signal can be monitored using solo. See Monitoring on page 74 for more information.

Emphasis

When a digital audio signal containing emphasis is connected to the digital stereo input, the 03D automatically detects it and de-emphasizes as necessary. Once a signal has been de-emphasized, it's processed and output by the 03D without emphasis. The 03D cannot apply emphasis to digital output signals.

Digital Input Monitor

The DIO Monitor page is used to monitor the channel status of IEC958 digital input signals (AES/EBU or COAXIAL) connected to the DIGITAL STEREO IN and YGDAI card. The DIGITAL STEREO IN can be set to either AES/EBU or COAXIAL on the D.in Setup page. See Digital Stereo In on page 221 for more information. The YGDAI input monitor works only when an AES/EBU CD8-AE-S YGDAI card is installed.

1. Use the [DIO] button to locate the Monitor page shown below.

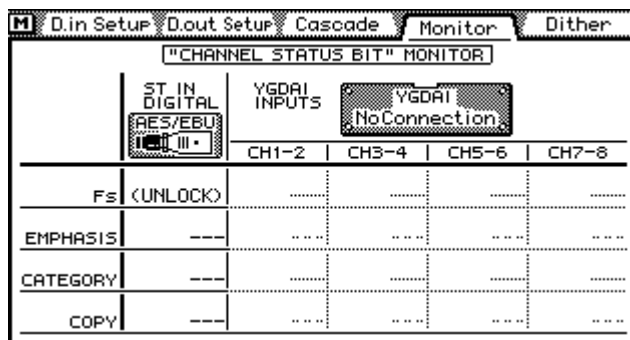

Fs—This field shows the sampling rate of a digital input signal.

32k	32 kHz sampling rate
44.1k	44.1 kHz sampling rate
48k	48 kHz sampling rate
None	Sampling rate unknown
UNLOCK	No signal connected or signal invalid

EMPHASIS—This field shows whether or not a digital input signal contains emphasis.

ON	Emphasis ON
OFF	Emphasis OFF
???	Unknown

CATEGORY—This field shows the category of a digital input signal. Only COAXIAL signals contain category information. When an AES/EBU signal is connected, AES/EBU is shown in this field.

General	Used temporarily
Laser Optical	Laser optical device (CD player, etc)
D/D Conv	Digital-to-digital converter and signal processor
D. Broadcast	Digital broadcast reception
Instruments	Musical instruments and sources that generate the original sound
A/D Conv	A/D converter (without copyright information)
A/D Conv with (C)	A/D converter (with copyright information)
Solid Memory	Solid memory device
Experimental	Experimental device
Unknown	Unknown device

COPY—This field shows the copy status of a digital input signal. Only COAXIAL signals contain copy information.

OK	Copy allowed
Prohibit	Copy prohibited

YGDAI Cards

About the YGDAI System

The YGDAI (Yamaha General Digital Audio Interface) system and optional YGDAI interface cards provide digital I/O support for several industry standard digital audio formats and protocols. Using a YGDAI card, the 03D's bus, aux, and input channel signals 1–16 can be output to other digital audio equipment, including digital multitrack recorders. The following YGDAI cards are available.

CD8-AT ADAT Card

The CD8-AT ADAT interface card is used to connect an 8-track ADAT MultiChannel Optical Interface compatible digital multitrack recorder, such as the Alesis ADAT, Alesis ADATxt, or Fostex RD-8.

CD8-TDII Tascam Card

The CD8-TDII interface card is used to connect an 8-track Tascam Digital Audio Interface (TDIF-1) compatible digital multitrack recorder, such as the Tascam DA-88 or DA-38.

CD8-AE-S AES/EBU Card

The CD8-AE-S interface card is used to connect digital audio equipment with AES/EBU digital I/O. Connection is via a 25-pin D-sub connector.

CD8-Y Yamaha Card

The CD8-Y interface card is used to connect equipment featuring Yamaha format multi-channel connections.

CD8-CS Cascade Card

The CD8-CS Cascade card is used to cascade two 03Ds together to expand the number of inputs. The CD8-CS Kit contains two CD8-CS interface cards and a cascade cable. See Cascading the 03D on page 227 for more information.

Card Specifications

Card	Description	Connectors
CD8-AT	ADAT Digital I/O	Optical x2
CD8-TDII	Tascam TDIF-1 Digital I/O	25-pin D-sub x1
CD8-AE-S ¹	AES/EBU Digital I/O	25-pin D-sub x1
CD8-Y	Yamaha Digital I/O	25-pin D-sub x1
CD8-CS KIT	Digital Cascade Kit ²	25-pin D-sub x1

1. Cable not included.
2. Kit includes two cards, one cable.

YGDAI Digital Inputs

The eight YGDAI digital inputs work as inputs for input channels 17 through 24, and cannot be reconfigured. See Input Channel Overview on page 36 for more information.

Emphasis

When a digital audio signal containing emphasis is connected to a YGDAI digital input, the 03D automatically detects it and de-emphasizes as necessary. Once a signal has been de-emphasized, it's processed and output by the 03D without emphasis. The 03D cannot apply emphasis to digital output signals.

Multitrack Recorders

The 03D's YGDAI slot provides eight digital inputs and outputs, and can be used to connect modular digital multitrack recorders, such as the Alesis ADAT or Tascam DA-88. The digital outputs can be any combination of bus outs, aux sends, and direct outputs from the first 16 input channels. So even though the 03D has only four bus outputs, up to eight tracks can be recorded simultaneously. When the 03D is used with a digital multitrack recorder, input channels 17 to 24 function as tape returns.

Assigning Signals to the YGDAI Outputs

The following table shows which signal sources can be assigned to the eight YGDAI digital outputs. Note that these signals are not sourced directly from the 03D buses. They are sourced from the actual outputs before D/A conversion. So they are affected, for example, by the stereo, bus, and aux send master faders, EQ, and dynamics processors.

Output	Source
1	BUS 1, AUX 1, Direct Out 1, Direct Out 9, or STEREO L
2	BUS 2, AUX 2, Direct Out 2, Direct Out 10, or STEREO R
3	BUS 3, AUX 3, Direct Out 3, Direct Out 11, or STEREO L
4	BUS 4, AUX 4, Direct Out 4, Direct Out 12, or STEREO R
5	BUS 1, AUX 1, Direct Out 5, Direct Out 13, or STEREO L
6	BUS 2, AUX 2, Direct Out 6, Direct Out 14, or STEREO R
7	BUS 3, AUX 3, Direct Out 7, Direct Out 15, or STEREO L
8	BUS 4, AUX 4, Direct Out 8, Direct Out 16, or STEREO R

1. Use the [DIO] button to locate the D.out Setup page shown below.

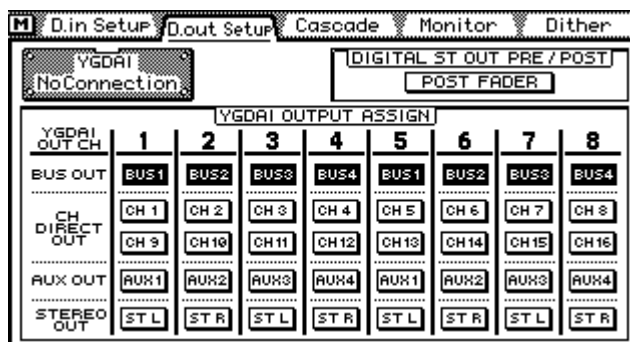

2. Use the cursor buttons to select the YGDAI OUTPUT ASSIGN switches, and the [ENTER] button to set them.

If you are using a mouse, simply click the switches.

The YGDAI card graphic at the top left of the D.out Setup page indicates the type of YGDAI card installed. The following table lists the available card types.

Indicator	Card	Description
No Connection	No card installed	—
adat	CD8-AT	ADAT Digital I/O
TASCAM	CD8-TDII	Tascam TDIF-1 Digital I/O
AES/EBU	CD8-AE-S	AES/EBU Digital I/O
YAMAHA	CD8-Y	Yamaha Digital I/O
CASCADE	CD8-CS KIT	Digital Cascade Kit



As an example, this is what the YGDAI card graphic displays when a CD8-AT ADAT card is installed.

YGDAI Block Diagram

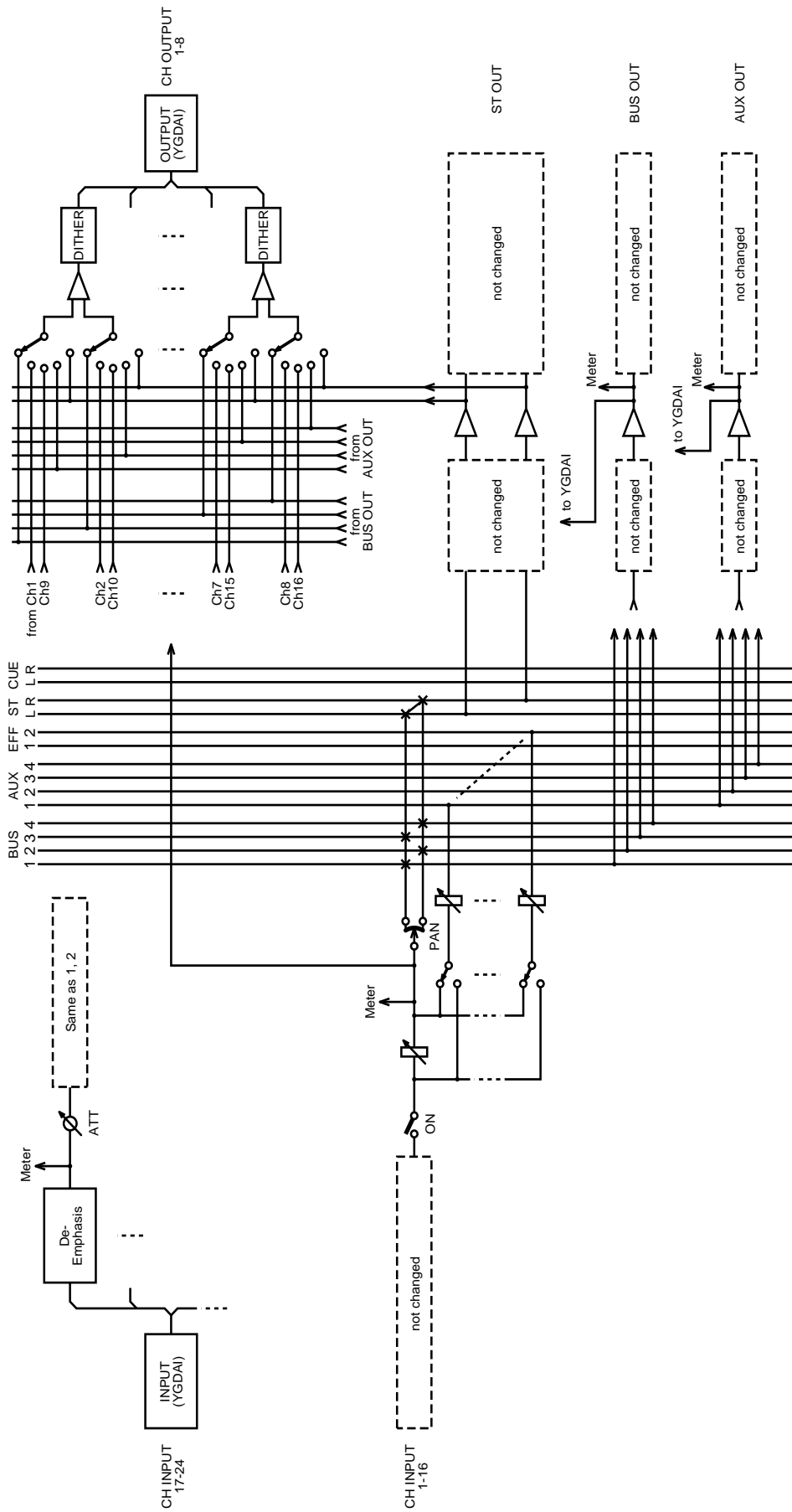

Installing YGDAI Cards

Warning: Turn off the 03D before installing a YGDAI card. Failure to do so is an electrical shock hazard, and may damage the 03D or card.

1. Turn off the 03D.
2. Undo the four fixing screws and remove the slot cover, as shown below.

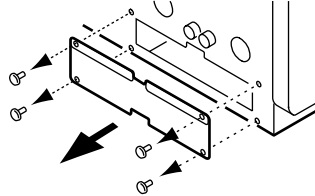

Keep the cover in a safe place for future use.

3. Insert the card into the slot as shown below. Push it in all the way so that the card's connector mates correctly with the internal 03D connector.

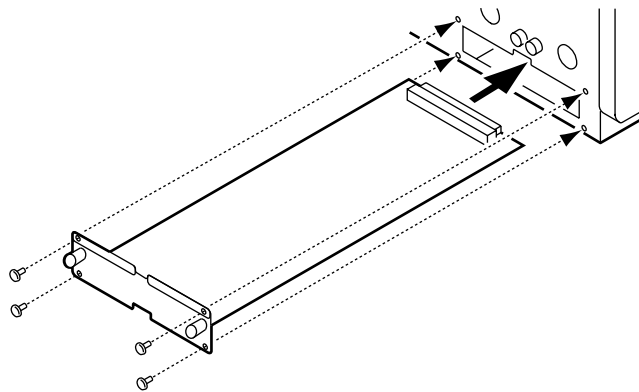

4. Secure the card using the four fixing screws.
5. Turn on the 03D.

The 03D checks to see what type of YGDAI card is installed when it's turned on. If installation is successful and the card is working correctly, the card type appears on the D.out Setup page. See Assigning Signals to the YGDAI Outputs on page 224 for more information.

Cascading the 03D

The CD8-CS Cascade Kit allows two 03Ds to work together as one 32-input mixing console, with both 03Ds sharing a common bus system (inputs 17–24 are not available when a cascade card is installed). The 03D can also be cascaded with the Yamaha 02R Digital Recording Console, which is an 8-bus console. The CD8-CS Cascade Kit contains two cards and one cable. This is all that is required to cascade two 03Ds or a 03D and 02R together.

When two consoles are cascaded together, one acts as master, the other as a slave. The IN/OUT switch on the CD8-CS card installed in the slave console is set to OUT. On the master console this switch is set to IN.

Note: Turn off the 03D before setting CD8-CS IN/OUT switches.

When a CD8-CS Cascade card is installed in the 03D, the cascade signal sources are selected automatically, and are not affected by the YGDAI OUTPUT ASSIGN settings on the D.out Setup page. The cascade signal configurations are explained in the following table.

Signal	Cascade Configuration
Bus	The Bus buses of both consoles are connected directly. The bus out signal levels are controlled using the bus out faders on the master console. Bus out faders on the slave console are essentially redundant.
Aux	The Aux buses of both consoles are connected directly. The aux send signal levels are controlled using the aux send faders on the master console. Aux send master faders on the slave console are essentially redundant.
Effects	The Effects buses of the slave and master consoles are not connected. This means that the onboard effects processors of both consoles can be used independently to process signals of the respective console.
Stereo	The Stereo buses of both consoles are connected directly. The stereo output signal level is controlled using the ST OUT fader on the master console. Two-track mastering and monitoring equipment should be connected to the master console. The ST OUT fader on the slave console is essentially redundant.
Solo	The Solo buses of both consoles are connected directly. Solo mode is engaged using the [SOLO] button on the master console. The [SOLO] button on the slave console is essentially redundant. Solo Status settings must be made on the master console. Listen, Sel mode, and safe channel settings are made on the respective console.

Cascade settings on the master console are made on the Cascade page, which is available only when a CD8-CS Cascade card is installed, and the IN/OUT switch on that card is set to IN. There are no configuration settings for the slave console.

1. Use the [DIO] button to locate the Cascade page shown below.

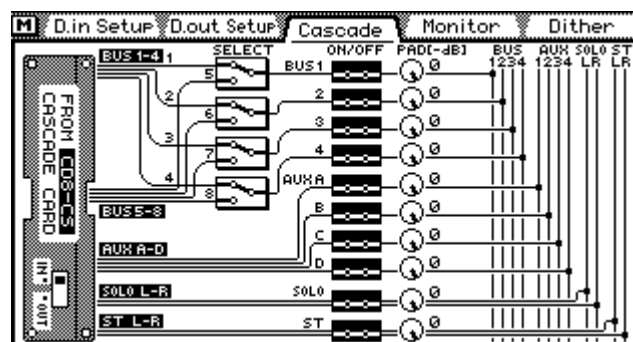

2. Use the cursor buttons to select the switches and controls and the [ENTER] button and PARAMETER wheel to set them.

If you are using a mouse, simply click and drag the parameters.

SELECT—These four switches are used to route the eight bus signals from the cascade card to the 03D’s four buses. If you’re cascading two 03Ds together, these switches should be set so that cascade bus 1 routes to 03D bus 1, cascade bus 2 routes to 03D bus 2, and so on. The 03D does not use buses 5 to 8, so there is no reason to select those buses. If you are cascading a 03D and 02R Digital Recording Console, however, you can use these switches to route four of the 02R’s eight buses to the 03D’s four buses.

ON/OFF—These switches are used to turn on and off the cascade input signals.

ATT—These controls are used to attenuate the cascade input signals from 0 dB to -96 dB.

Cascade Delay

The following illustrations show the amount of signal delay that occurs when 03Ds and 02Rs are cascaded together. The left-channel signal is fed into the first mixer and the right-channel signal is fed into the second mixer. As the left-channel signal passes through both mixers, it’s delayed compared to the right-channel signal, which passes through only one mixer. By delaying the right-channel signal on the second mixer, both signals can be brought into phase. Use the Delay function to correct cascade delay. See Channel Delay on page 40 for more information.

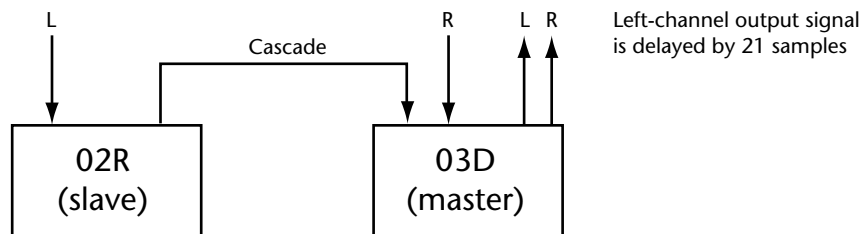
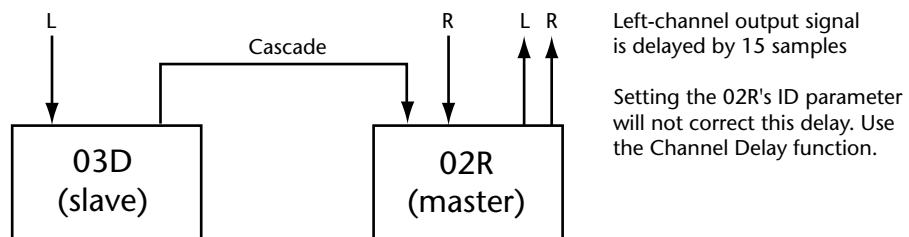
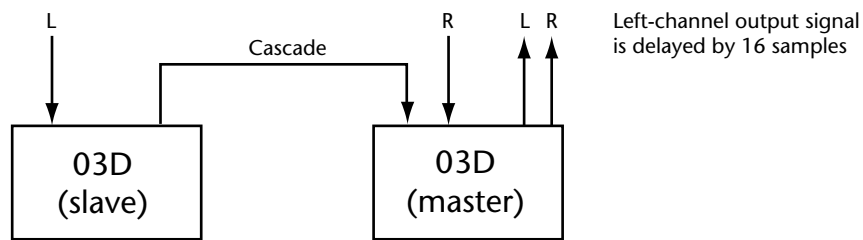

Using Solo with Cascade

When two consoles are cascaded together, the Solo buses of both consoles are connected. Solo mode is engaged using the [SOLO] button on the master console. The [SOLO] button on the slave console is essentially redundant. Also, solo Status settings must be made on the master console. Listen, Sel mode, and safe channel settings, however, are made on the respective console.

1. **Set the Solo Status on the Solo Setup page of the cascade master.**
This setting cannot be made on the cascade slave.
2. **Press the [SOLO] button on the cascade master.**
3. **Use the [SEL] buttons on each mixer to solo channels.**
Solo signals are output through the monitor section of the cascade master.
4. **Press the [SOLO] button on the cascade master to cancel solo.**

Cascade Block Diagram

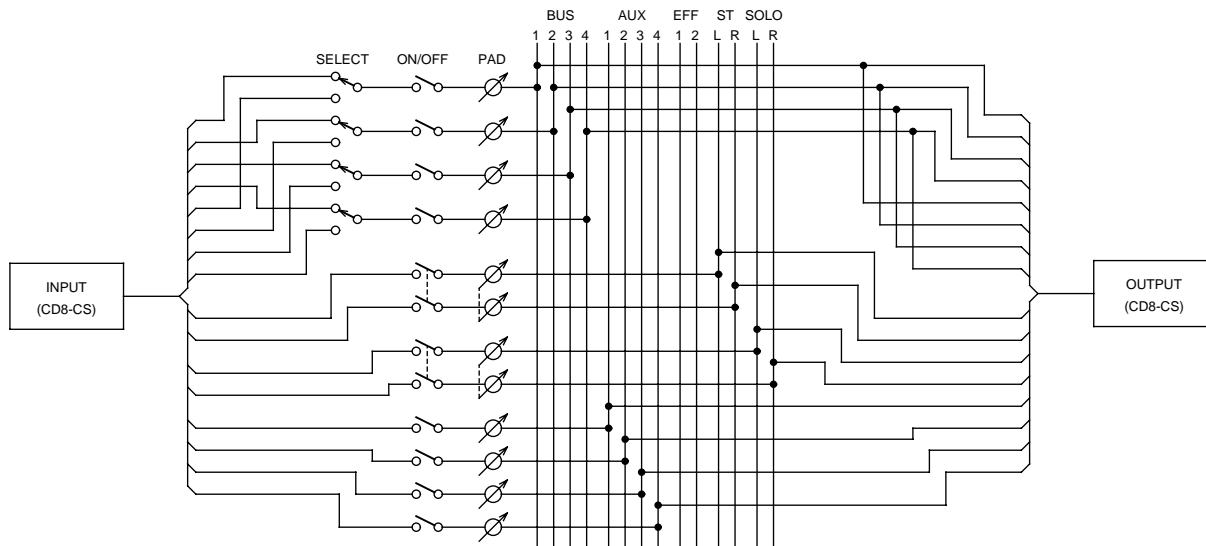

19

In this chapter...

MIDI and the 03D	232
MIDI Connectors & TO HOST	232
MIDI & TO HOST Data Receive Indicators	233
MIDI/HOST Setup	233
MIDI Setup	235
MIDI Monitor	238
Program Change Assign	239
Control Change Assign	240
Bulk Dump	242
MIDI Remote	243

MIDI and the 03D

The 03D works with MIDI in the following ways:

- Program Changes for mix scene recall (see Program Change Assign on page 239)
- Control Changes for real-time mix parameter control (Control Change Assign on page 240)
- System Exclusive for parameter control (*System Exclusive Parameter Control* on page 241)
- Bulk Dump for data backup and transfer between 03Ds (see Bulk Dump on page 242)
- MTC (MIDI Timecode) and MIDI Clock for automix synchronization (see Setting the Time Base on page 181)
- Note On/Off for fader start (MIDI Setup on page 235)
- Note On/Off for freeze effect control (see FREEZE (Effect 2 only) on page 141)
- MMC (MIDI Machine Control and MIDI Real Time Messages) for remote machine control (see User Define Buttons on page 208)
- MIDI Remote (see MIDI Remote on page 243)

MIDI Connectors & TO HOST

In addition to standard MIDI IN, OUT, and THRU connectors, the 03D features a TO HOST connector. This allows the 03D to be connected directly to a personal computer without a MIDI interface. By connecting other MIDI gear to the 03D's standard MIDI connectors, the 03D can be used as MIDI interface for other gear too.

The TO HOST connection is a two-way connection, which means it carries MIDI messages from the 03D and 03D MIDI IN to a controlling computer, and from the controlling computer to the 03D and the 03D's MIDI OUT.

The TO HOST connection can be used in one of two modes: STANDARD I/F or MULTIPORT. TO HOST can be used as a personal computer MIDI interface in either mode. TO HOST modes are selected on the MIDI/HOST page. See MIDI/HOST Setup on page 233 for more information.

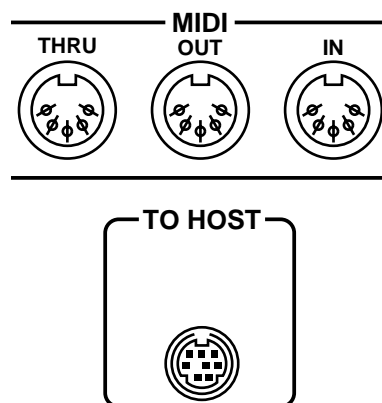

Standard I/F

In STANDARD I/F mode, the TO HOST connection works like an extra MIDI IN and MIDI OUT.

MULTIPORT

In MULTIPORT mode, TO HOST operation is virtually the same as in STANDARD I/F mode except for the addition of MIDI Port Select messages. In this way the 03D functions like it has multiple MIDI ports, although physically it does not have multiple ports. Multiple ports provide multiple MIDI Channels, overcoming the 16 MIDI Channel limit and preventing MIDI Channel conflicts. Your controlling software or MIDI sequencer software must support multiple ports to use this mode.

In MULTIPORT mode, the 03D's general MIDI functions work with MIDI messages received on Port 1. Although you can select different ports for MTC, MIDI Real-Time messages, MMC, Fader Start, and the four MIDI Remote pages. Port 2 data is echoed through to the MIDI OUT for connection to other MIDI gear.

The 03D Multiport mode does not support fast MIDI, which is used by some multiport devices and software.

MIDI & TO HOST Data Receive Indicators

- MIDI** When MIDI data is received at the MIDI IN connection, the MIDI data receive indicator flashes on the display.
- HOST** When data is received at the TO HOST connection, the HOST data receive indicator flashes on the display.

MIDI/HOST Setup

The MIDI/HOST page is used to set the TO HOST mode and port and MIDI Channel settings for MTC, MIDI Real-Time messages, MMC, Fader Start, and MIDI Remote.

1. Use the [UTILITY] button to locate the MIDI/HOST page shown below.

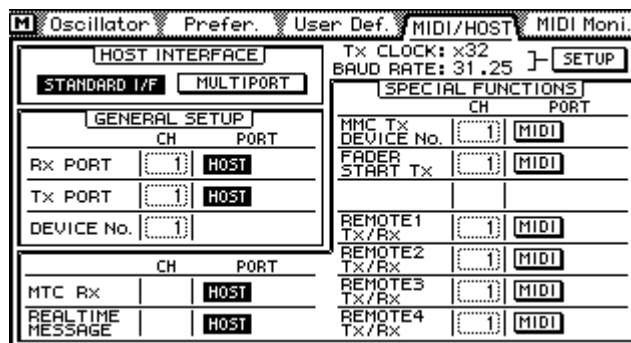

2. Use the cursor buttons to select the parameter switches and the [ENTER] button to set them. Use the PARAMETER wheel to set parameter values. If you are using a mouse, simply click the parameter switches. Position the mouse cursor over parameter values, press and hold the left mouse button, and then drag the mouse to set them.
3. Set the TO HOST mode to either STANDARD I/F or MULTIPORT.

STANDARD I/F Mode

In the GENERAL SETUP window, set the general receive and transmit ports to either MIDI (i.e., standard MIDI connectors) or HOST (i.e., the TO HOST connector). These general settings affect Program Changes, Control Changes, and Note On/Off messages. The receive (Rx PORT), transmit (Tx PORT), and Device No. parameters are duplicated on the MIDI Setup page. See MIDI Setup on page 235 for more information.

Setting the Rx PORT and Tx PORT to different ports (e.g., Rx PORT to MIDI and Tx PORT to HOST) allows you to chain MIDI gear together, as shown below.

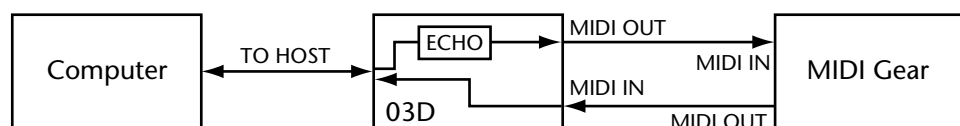

In this case, MIDI messages received at the TO HOST connection are echoed through to the MIDI OUT connector according to the ECHO parameters on the MIDI Setup page. See MIDI Setup on page 235 for more information. While MIDI messages received at the 03D's MIDI IN pass through the 03D to the controlling computer via the TO HOST connection.

The Port can be set independently for the following parameters:

MTC Rx—This port switch determines whether the 03D receives MTC from the MIDI IN or TO HOST.

REAL TIME MESSAGE—This port switch determines whether the 03D receives and transmits MIDI Real-time System messages (MIDI Clock, etc) via the MIDI IN and MIDI OUT or TO HOST.

MMC Tx Device No.—This switch determines which port the 03D uses to transmit MMC messages; MIDI OUT or TO HOST. The device number can be set, beginning from 1. Note that if the device receiving the MMC starts its device numbering scheme from 0, you'll have to set the 03D device number to the next lower number.

FADER START Tx—This port switch determines which port the 03D uses to transmit Note On/Off messages: MIDI OUT or TO HOST. The MIDI Channel can also be set. Fader start can be turned on or off on the MIDI Setup page. See MIDI Setup on page 235 for more information.

REMOTE1–4 Tx/Rx—These four port switches determine which ports the 03D uses to transmit and receive MIDI Remote messages for the four MIDI Remote pages: MIDI OUT or TO HOST. The MIDI Channel can be set for each MIDI Remote page. When the GM, User Define or Pro Tools remote page is used, MIDI Remote data is transmitted and received on all channels regardless of this setting. See MIDI Remote on page 243 for more information.

MULTIPOINT Mode

In MULTIPORT Mode, the PORT parameters in the GENERAL SETUP window are set to HOST–1 FIX, which means Port 1. This setting cannot be changed. These general settings affect Program Changes, Control Changes, and Note On/Off messages. MIDI messages transmitted and received on Port 2 pass between the TO HOST and MIDI connectors in accordance with the OTHER COMMANDS ECHO and REAL TIME MSG. & MTC ECHO settings.

When the MTC Rx or REAL TIME MESSAGE (MIDI Clock, etc) parameter is set to HOST, you can select a port from 1 to 8, 17, or ALL.

Port 17 is normally used in multi-port system for SMPTE timecode or for an additional standard MIDI interface. When ALL is selected, MTC and MIDI Clock are received at all ports. Real Time Messages assigned to the USER DEFINE buttons are output from port 0 when these parameters are set to ALL.

When the MMC Tx Device No., FADER START Tx, and REMOTE1–4 Tx/Rx parameters are set to HOST, you can select a port from 1 to 8. If you set each parameter to a unique port you can use the same MIDI Channel.

TO HOST Baud Rate

The TO HOST baud rate and transmission clock speed is displayed in the top-right corner of the MIDI/HOST page, as shown here. You can change these settings by

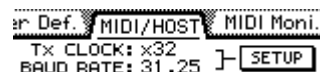

selecting the SETUP switch and then pressing the [ENTER] button. If you are using a mouse, simply click the SETUP switch. The following dialog box appears.

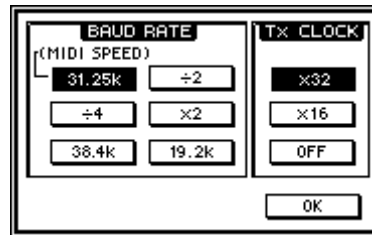

These settings are really intended for those who write their own computer programs to control the 03D. You should not change them unless you know what you are doing. If you are using a standard MIDI sequencer program, use the following settings.

Computer Type	BAUD RATE	Tx CLOCK
Macintosh	31.25K	x32
Windows PC	(Some Windows PC software may need to use 38.4K)	OFF

The x2, +2, and +4 settings apply only to the 31.25K BAUD RATE.

If the 38.4K or 19.2K BAUD RATE is used, Tx CLOCK is fixed at OFF.

MIDI Setup

The MIDI Setup page is used to configure basic 03D MIDI parameters, such as MIDI transmit (Tx) and receive (Rx) Channels, OMNI on/off, echo on/off, and so on.

1. Use the [MIDI] button to locate the MIDI Setup page shown below.

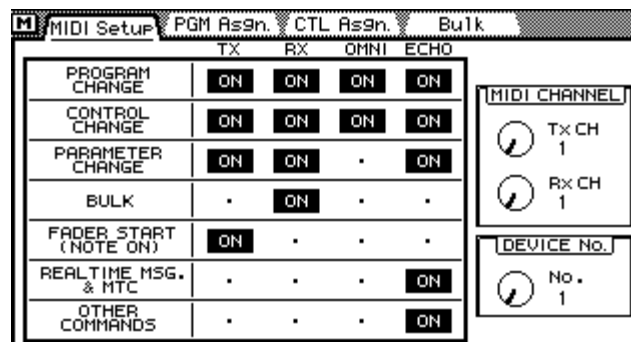

2. Use the cursor buttons to select the parameter switches and the [ENTER] button to set them. Use the PARAMETER wheel to set the rotary controls. If you are using a mouse, simply click the parameter switches and drag the rotary controls.

PROGRAM CHANGE—Program Change messages are used to recall mix scenes. See Program Change Assign on page 239 for more information. The four switches in this group are as follows. Tx determines whether or not the 03D transmits Program Change messages. Rx determines whether or not the 03D receives Program Change messages. OMNI determines whether or not the 03D receives Program Change messages on all 16 MIDI Channels. When OMNI is on, Program Change messages are received regardless of the MIDI CHANNEL Rx parameter settings. ECHO determines whether or not Program Change messages are echoed to the MIDI OUT.

CONTROL CHANGE—Control Change messages are used to control 03D parameters in real time. See Control Change Assign on page 240 for more information. The four switches in this group are as follows. Tx determines whether or not the 03D transmits

Control Change messages. Rx determines whether or not the 03D receives Control Change messages. OMNI determines whether or not the 03D receives Control Change messages on all 16 MIDI Channels. When OMNI is on, Control Change messages are received regardless of the MIDI CHANNEL Rx parameter settings. ECHO determines whether or not Control Change messages received on the specified MIDI Channel (Rx CH) are echoed to the MIDI OUT.

PARAMETER CHANGE—Parameter Change System Exclusive messages are used to control 03D parameters in real time. The three switches in this group are as follows. Tx determines whether or not the 03D transmits Parameter Change System Exclusive messages. Rx determines whether or not the 03D receives Parameter Change System Exclusive messages. ECHO determines whether or not Parameter Change System Exclusive messages received on the specified MIDI Channel (Rx CH) are echoed to the MIDI OUT.

BULK—This switch determines whether or not the 03D receives MIDI Bulk Request messages and MIDI Bulk Dump data.

FADER START (NOTE ON)—When Fader Start is set to ON, a MIDI Note On message is transmitted when the fader of an odd-numbered channel is raised from infinity (∞). This can be used in conjunction with a “MIDI to trigger” interface box to automatically start CD players, tape decks, etc. This function is intended for use with channels configured as a stereo pair. That’s why only the odd-numbered channel causes a MIDI Note On message to be transmitted. When the fader is lowered back to infinity, a corresponding MIDI Note Off message is transmitted, which can be used to stop playback on the CD player or tape deck.

Fader	MIDI Note No.	Note On	Note Off
CH 1	37	9n 25 7f	9n 25 00
CH 3	38	9n 26 7f	9n 26 00
CH 5	39	9n 27 7f	9n 27 00
CH 7	40	9n 28 7f	9n 28 00
CH 9	41	9n 29 7f	9n 29 00
CH 11	42	9n 2a 7f	9n 2a 00
CH 13	43	9n 2b 7f	9n 2b 00
CH 15	44	9n 2c 7f	9n 2c 00

REAL TIME MSG. & MTC—This switch determines whether or not real-time messages and MTC are echoed. This is used when a device connected through the 03D needs to be synchronized. Echoed messages include the following:

MTC Quarter Frame Message (F1h **h)

Song Position Pointer (F2h **h **h)

Song Select (F3h **)

MIDI Clock (F8h)

Start (FAh), Continue (FBh), Stop (FCh)

MTC Message (F0h 7Fh 7Fh 01h...F7h)

Operation of this echo switch depends on the HOST INTERFACE setting on the MIDI/HOST page (MIDI/HOST Setup on page 233). When the HOST INTERFACE is set to STANDARD I/E, this switch affects data echoed from the MIDI IN to the MIDI OUT. When set to MULTIPORT, however, it affects data echoed from PORT 2 to the MIDI OUT.

OTHER COMMANDS—This switch determines whether or not MIDI data other than that set using the PROGRAM CHANGE, CONTROL CHANGE, PARAMETER CHANGE, and REAL TIME MSG. & MTC switches is echoed.

Operation of this echo switch depends on the HOST INTERFACE setting on the MIDI/HOST page (MIDI/HOST Setup on page 233). When the HOST INTERFACE is set to STANDARD I/E, this switch affects data echoed from the MIDI IN to the MIDI OUT. When set to MULTIPORT, however, it affects data echoed from PORT 2 to the MIDI OUT.

MIDI CHANNEL—These controls are used to select the MIDI Channels that the 03D uses to transmit and receive MIDI data. The Tx control sets the transmit MIDI Channel. The Rx control sets the receive MIDI Channel.

The onboard effects processors feature a freeze effect that can be triggered using MIDI Note On and Off messages received on the Rx Channel. See FREEZE (Effect 2 only) on page 141 for more information.

DEVICE No.—This control is used to set the Device No., which is used for MIDI Bulk Dump and Parameter Change System Exclusive messages. When the 03D transmits a Bulk Dump data request message, the receiving device uses the Device No. to transmit the requested Bulk Dump data to that 03D. Other 03Ds ignore the Bulk Dump data. Basically, the Device No. determines the MIDI Channel used for System Exclusive data transfer. If you are using only one 03D, the Device No. can be set at 1. If you are using more than one 03D, however, set each 03D to a different Device No.

MIDI Monitor

The MIDI Moni. page is used to monitor data received at the MIDI IN and TO HOST connections. Data is displayed in a hexadecimal format.

1. Use the [UTILITY] button to locate the MIDI Moni. page shown below.

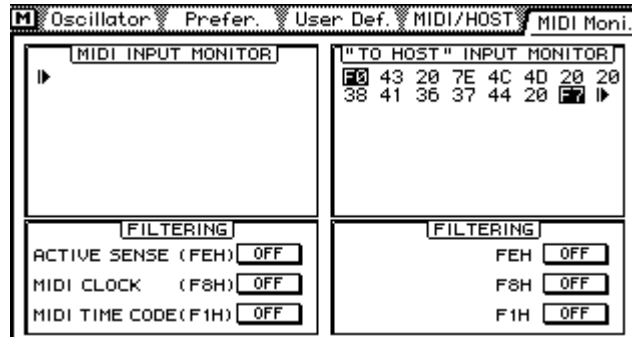

MIDI data received at the MIDI IN connection is monitored in the MIDI INPUT MONITOR window. Data received at the TO HOST connection is monitored in the TO HOST INPUT MONITOR window. Status bytes with an MSB (Most Significant Byte) of 1 are highlighted.

Active Sensing (FEH), MIDI Clock (F8H), and MTC Quarter Frame Messages (F1H **H) can be filtered from the MIDI IN and TO HOST windows independently.

2. Use the cursor buttons to select the filter switches in the Filtering windows and the [ENTER] button to turn them on and off.

If you are using a mouse, simply click the filter switches.

Program Change Assign

The PGM Asgn. page is used to assign 03D scene memories to MIDI Program Changes. Program Change messages can be used to recall 03D mix scenes. See Using MIDI Program Change Messages on page 169 for more information. Scene memories can be assigned to Program Change messages from 1 to 128. Initially, scene memories 1 to 50 are assigned sequentially to Program Changes 1 to 50. Scene memory 00 is assigned to Program Change 51.

When using MIDI Program Change messages to recall mix scenes, be sure to configure the MIDI Setup page. See MIDI Setup on page 235 for more information.

1. Use the [MIDI] button to locate the PGM Asgn. page shown below.

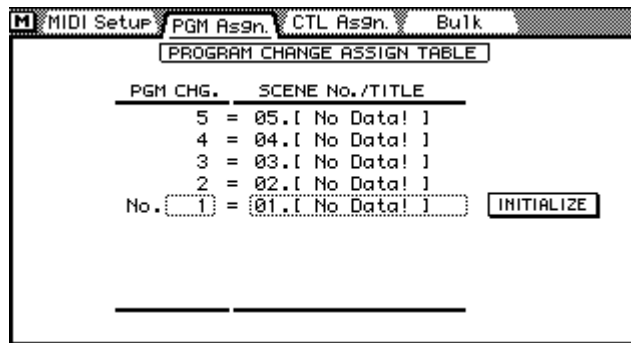

2. Use the cursor buttons to select the PRM CHG. column, and then use the PARAMETER wheel to select a Program Change.

If you are using a mouse, position the mouse cursor over the PRM CHG. parameter box, press and hold the left mouse button, and then drag the mouse.

3. Press the [▶] cursor button to select the SCENE No./TITLE column, and then use the PARAMETER wheel to select a scene memory.

If you are using a mouse, position the mouse cursor over the SCENE No./TITLE parameter box, press and hold the left mouse button, and then drag the mouse.

To reset the Program Change assignments to their initial settings, use the cursor buttons to select the INITIALIZE switch, and then press the [ENTER] button. If you are using a mouse, simply click the INITIALIZE switch. The dialog box shown here appears. Click OK to initialize.



A scene memory to Program Change assignment table is provided on page 267. The scene memory to Program Change assignment table can be backed up to an external MIDI device, such as a MIDI data filer, using MIDI Bulk Dump. See Bulk Dump on page 242 for more information.

Control Change Assign

The CTL Asgn. page is used to assign 03D parameters to MIDI Control Changes. Control Changes can be used to control 03D mix settings in real time. When an 03D mix parameter is adjusted, a Control Change message is transmitted. This message could be recorded to a MIDI sequencer or controlling computer. When the sequence is played back, the 03D parameter is adjusted automatically. Similarly, 03D mix settings can be controlled by transmitting Control Changes from other MIDI devices. For example, a synthesizer with assignable sliders. Up to 114 03D mix parameters can be assigned to Control Changes 0 to 95 and 102 to 119 (Control Changes 96 to 101 cannot be used). See Parameter to Control Change Table on page 268 for more information.

When using MIDI Control Change messages to control mix settings, be sure to configure the MIDI Setup page. See MIDI Setup on page 235 for more information.

1. Use the [MIDI] button to locate the CTL Asgn. page shown below.

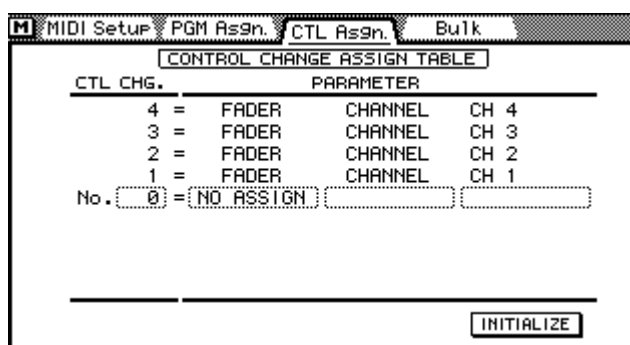

2. Use the cursor buttons to select the CTL CHG. column, and then use the PARAMETER wheel to select a Control Change.

If you are using a mouse, position the mouse cursor over the PRM CHG. parameter box, press and hold the left mouse button, and then drag the mouse.

Control Changes 0 and 32 are used in conjunction with Program Change and Bank Select messages. Some MIDI sequencers may not record these Control Changes from the 03D correctly. If this is a problem, set Control Changes 0 and 32 to NO ASSIGN.

3. Press the [▶] cursor button, and then use the PARAMETER wheel to select a mix parameter.

If you are using a mouse, position the mouse cursor over the parameter box, press and hold the left mouse button, and then drag the mouse.

4. Press the [▶] cursor button, and then use the PARAMETER wheel to select a channel.

If you are using a mouse, position the mouse cursor over the parameter box, press and hold the left mouse button, and then drag the mouse.

5. Press the [▶] cursor button, and then use the PARAMETER wheel to select a channel number.

If you are using a mouse, position the mouse cursor over the parameter box, press and hold the left mouse button, and then drag the mouse.

To reset the Control Change assignments to their initial settings, use the cursor buttons to select the INITIALIZE switch, and then press the [ENTER] button. If you are using a mouse, simply click the INITIALIZE switch. The dialog box shown here appears. Click O3D DEFAULT to

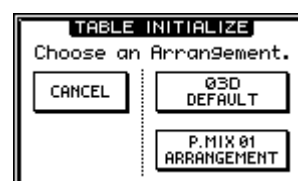

initialize. The P.MIX 01 ARRANGEMENT option is used to configure Control Changes for use with a Yamaha Programmable Mixer 01 Digital Mixer.

A parameter to Control Change assignment table is provided on page 268. The parameter to Control Change assignment table can be backed up to an external MIDI device, such as a MIDI data filer, using MIDI Bulk Dump. See Bulk Dump on page 242 for more information.

Pair, group, library recall parameters, etc., cannot be assigned to Control Changes. They can, however, be controlled using System Exclusive messages.

For parameters that are split into L and H, Control Changes will not be output if H is not assigned. Also, if only H is assigned, the resolution will be less, causing a discrepancy between transmission and reception. Furthermore, the effect parameters for DELAY LCR time and FREEZE point use two parameters consisting of four parameter areas (L, H, L, H). Be aware of this when making adjustments.

The Q parameter of the high and low EQ bands can be set to shelving or filter using System Exclusive messages, but not Control Change messages. This is to prevent accidental changes while using a MIDI controller. Control Changes can, however be used to adjust the Q parameter over its normal range from 10.0 to 0.01.

System Exclusive Parameter Control

Parameters that cannot be assigned to Control Changes can be controlled in real time by transmitting and receiving System Exclusive messages. See MIDI Data Format on page 271 for more information.

Bulk Dump

From the Bulk page, 03D data can be dumped to and from other MIDI devices, such as a MIDI data file, controlling computer, or another 03D. This can be used to backup 03D data, or transfer data between 03Ds.

1. Use the [MIDI] button to locate the Bulk page shown below.

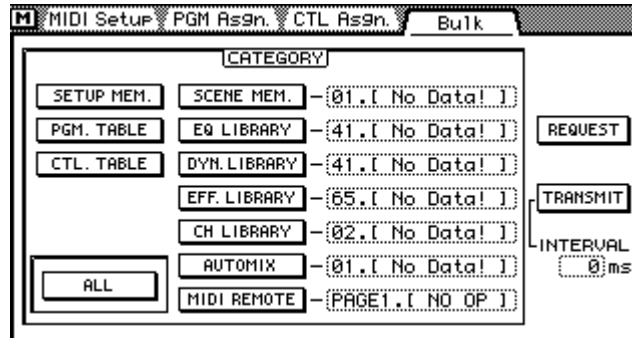

2. Use the cursor buttons to select a data type switch, and then press the [ENTER] button.
If you are using a mouse, simply click the data type switch.
3. Use the cursor buttons to select the parameter box adjacent to the selected data type, and then use the PARAMETER wheel to select individual memories and programs.

Data Type	Range	Description
SETUP MEM.	—	Various settings
PGM. TABLE	—	PGM Asgn. page settings (scene memory to Program Change assignment table)
CTL. TABLE	—	CTL Asgn. page settings (parameter to Control Change assignment table)
SCENE MEM.	1–50, EDIT BUFFER, ALL	Scene memory data
EQ LIBRARY	41–80, ALL	EQ library user programs
DYN. LIBRARY	41–80, ALL	Dynamics library user programs
EFF. LIBRARY	65–96, ALL	Effects library user programs
CH LIBRARY	2–50, ALL	Channel library user programs
AUTOMIX	1–4, CURRENT AUTO, ALL	Automix data
MIDI REMOTE	1–4	MIDI remote data

4. To transmit or request all data, select the ALL switch.
ALL allows you to transmit or request the data of all 10 categories.
5. Use the cursor buttons to select the REQUEST or TRANSMIT switch, and then press the [ENTER] button.

When REQUEST is pressed, the 03D transmits a MIDI Bulk Dump Request message. The receiving device then transmits the requested Bulk Dump data to the 03D. When TRANSMIT is pressed, the 03D transmits the specified data.

TRANSMIT INTERVAL—This parameter specifies the interval between data blocks during Bulk Dump transmission. MIDI devices with a relatively small data buffer can easily be overloaded with MIDI data. Setting an interval of, say, 300 ms allows a slower device to process the received MIDI data correctly. An interval setting of 0 can be used when transferring Bulk Dump data between 03Ds.

MIDI Remote

The MIDI Remote function allows you to control other MIDI equipment from the 03D. Connection can be made using MIDI IN/OUT or the TO HOST connection. Remote equipment can be controlled using the 03D faders, [ON] buttons, cursor buttons, and PARAMETER wheel.

The following MIDI equipment can be controlled from the 03D.

- Digital mixers—Yamaha Programmable Mixer 01, 02R, 03D
- Digital effects processors—Yamaha ProR3, REV500
- GM tone generator
- XG tone generator
- Pro Tools
- User defined (user defined MIDI commands)

Up to four display pages can be configured for use with the above.

Connecting for Remote Control

The following illustration is an example of how equipment can be connected to the 03D for remote control operation.

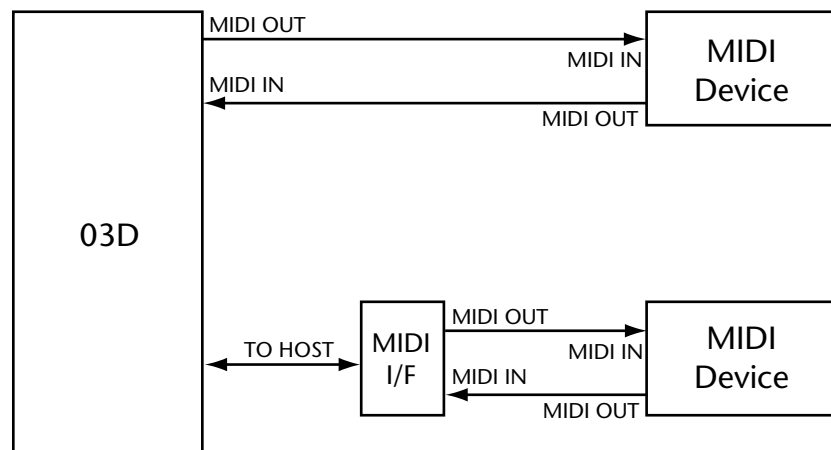

Assigning Devices to MIDI Remote Pages

Four MIDI Remote pages are available and each can be assigned to one device.

1. Use the [MIDI REMOTE] button to locate the Setup page shown below.

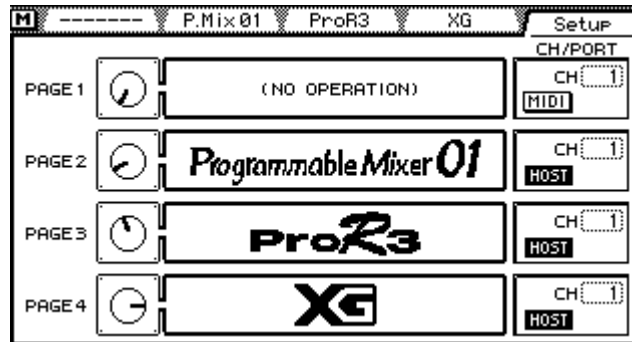

2. Use the cursor buttons to select a page's rotary control, and then use the PARAMETER wheel to select a device.
If you are using a mouse, position the mouse cursor over a rotary control, press and hold the left mouse button, and then drag the mouse.
3. Use the cursor buttons to select the CH/PORT parameters, and then use the [ENTER] button and PARAMETER wheel to set them.

If you are using a mouse, simply click the CH/PORT switches. Position the mouse cursor over the CH parameters, press and hold the left mouse button, and then drag the mouse.

The CH/PORT parameters determine which ports the 03D uses to transmit and receive MIDI Remote messages for the four MIDI Remote pages: MIDI OUT or TO HOST. The MIDI Channel can be set for each MIDI Remote page.

The CH/PORT settings can also be made on the MIDI/HOST page of the Utility function. See MIDI/HOST Setup on page 233 for more information.

Programmable Mixer 01, 02R, 03D Pages

The same remote control functions are available for the Programmable Mixer 01, 02R, and 03D. The following table lists the mixer parameters that can be controlled from the 03D.

03D Control	Programmable Mixer 01, 02R, 03D Parameter
Channel faders	Channel faders
[ON] buttons	Channel ON/OFF
Display functions	Pan
	Mix scene recall

1. Use the [MIDI REMOTE] button to locate the P.Mix01, 02R, or 03D page.

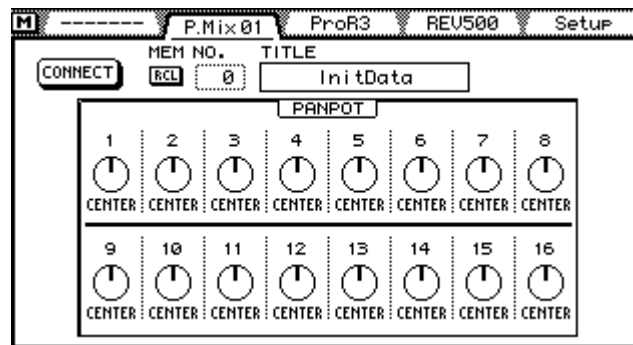

03D channel faders 1 to 16 correspond to faders 1 to 16 on the remote mixer. Adjusting an 03D fader changes the corresponding fader on the remote mixer.

03D [ON] buttons 1 to 16 correspond to [ON] buttons 1 to 16 on the remote mixer. Operating an 03D [ON] button mutes the corresponding channel on the remote mixer.

To adjust the pan on the remote mixer, select a pan control on the display and use the PARAMETER wheel. The corresponding pan control on the remote mixer changes.

To recall a mix scene on the remote mixer, select the MEM NO. parameter and use the PARAMETER wheel to choose a mix scene. The TITLE of the mix scene does not yet appear. Select the RCL switch, and then press the [ENTER] button to recall the mix scene on the remote mixer. The mix scene is recalled and the 03D's fader positions are updated to reflect the remote mixer's new fader positions, and the pan controls on the 03D's display are updated to show the new pan positions. The 03D's [ON] button indicators show the mute status of the remote mixer channels.

The Connect function can be used to update the 03D's fader positions, display pan controls, and [ON] buttons to reflect those of the remote mixer when the remote mixer is first connected or turned on. To execute the Connect function, select the CONNECT switch, and then press the [ENTER] button.

If you are controlling a Programmable Mixer 01, set its Control Change Assign mode to Register.

If you are controlling an 03D, make the following settings on its MIDI Setup page: PROGRAM CHANGE RX= ON, PROGRAM CHANGE ECHO=OFF, CONTROL CHANGE TX=OFF, CONTROL CHANGE ECHO=OFF, PARAMETER CHANGE TX and RX both=ON, PARAMETER CHANGE ECHO=OFF, and BULK RX=ON. The MIDI RX CH, MIDI TX CH and DEVICE NO. should match the Remote MIDI Channel number. So that the remote 03D doesn't affect the mix scene functions on the controlling 03D, set CONTROL CHANGE RX=OFF on the controlling 03D.

ProR3, REV500 Pages

The following table lists the reverb parameters that can be controlled from the 03D.

03D Control	ProR3, REV500 Parameter
Channel faders	Reverb parameters
Display functions	Reverb parameters
	Reverb program recall

03D faders control the same parameters as those on the display.

1. Use the [MIDI REMOTE] button to locate the ProR3 or REV500 page.

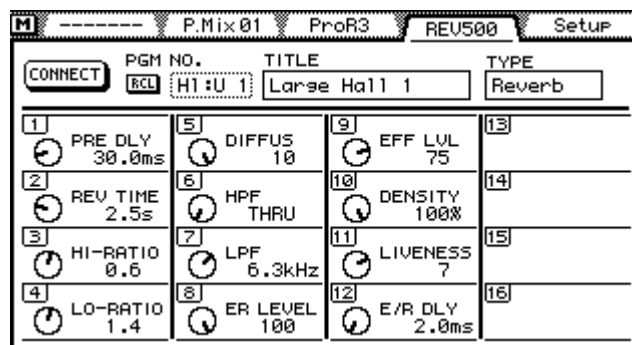
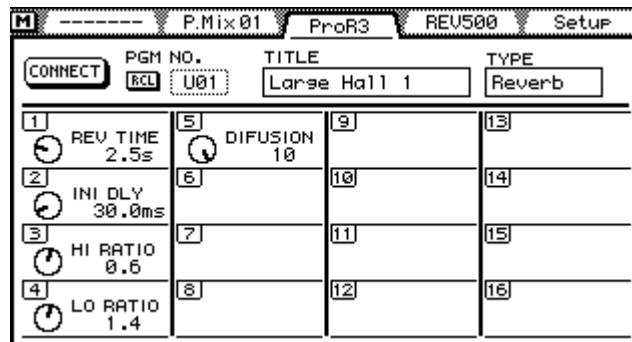

To recall a reverb program, select the PGM NO. parameter and use the PARAMETER wheel to choose a program. The TITLE of the program and TYPE do not yet appear. Select the RCL switch, and then press the [ENTER] button to recall the reverb program on the ProR3 or REV500. The reverb program is recalled and the 03D's faders and display controls are updated to reflect the new parameter positions.

To edit a reverb parameter from the 03D, select the parameter on the display and use the PARAMETER wheel. Alternatively, adjust the corresponding 03D fader.

The Connect function can be used to update the 03D's faders and display controls when the ProR3 or REV500 is first connected, turned on, or a parameter is edited or program is recalled manually. To execute the Connect function, select the CONNECT switch, and then press the [ENTER] button.

GM Tone Generator Page

The following table lists the GM tone generator parameters that can be controlled from the 03D. MIDI Channels do not have to be set.

03D Control	GM Tone Generator Parameter
Channel faders	Channel levels
Display functions	Pan
	Expression
	Two assignable Control Changes

1. Use the [MIDI REMOTE] button to locate the GM page.

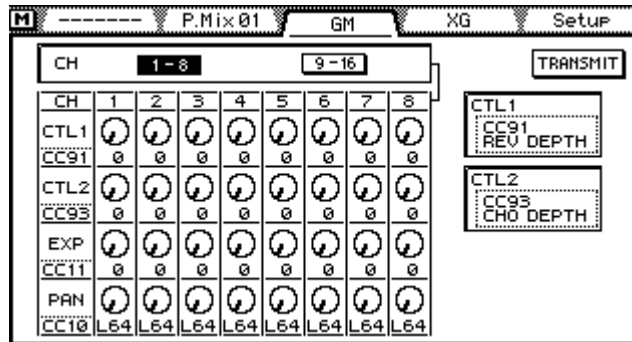

The 03D display shows Control Change 1, Control Change 2, Expression, and Pan controls for channels 1 to 8 or channels 9 to 16. Use the CH switches to select these channel groups. When an 03D fader in group 1 to 8 or group 9 to 16 is operated, the corresponding group is selected on the display.

03D channel faders 1 to 16 correspond to channels 1 to 16 on the GM tone generator. Adjusting an 03D fader changes the corresponding level on the tone generator.

To adjust the pan or expression on the GM tone generator, select a pan or expression control on the display and use the PARAMETER wheel. The corresponding pan or expression control on the tone generator changes.

The Control Change 1 and Control Change 2 controls operate in the same way as the pan and expression controls, however you can assign different Control Changes to them.

The Transmit function can be used to transmit the 03D's faders and display controls to the GM tone generator. To execute the Transmit function, select the TRANSMIT switch, and then press the [ENTER] button.

XG Page

The following table lists the XG tone generator parameters that can be controlled from the 03D.

03D Control	XG Tone Generator Parameter
Channel faders	Part levels
Display functions	Reverb levels
	Chorus levels
	Variation levels or Variation Assign switches
	Pan
	Reverb, Chorus, and Variation return levels
	Master volume

1. Use the [MIDI REMOTE] button to locate the XG page.

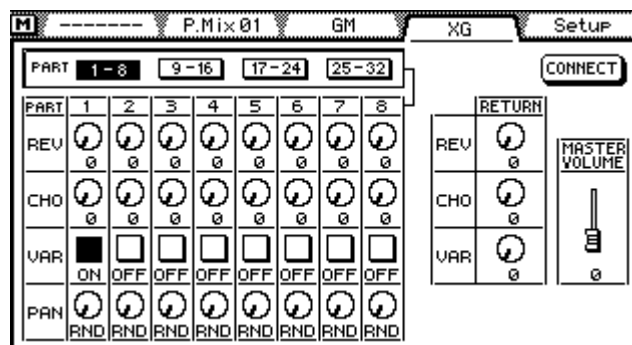

2. Set the MIDI Channel to match the device number of the XG tone generator. See MIDI/HOST Setup on page 233 for more information.

The 03D display shows Reverb, Chorus, Variation, and Pan controls for parts 1 to 8, 9 to 16, 17 to 24, and 25 to 32 in four groups. Use the PART switches to select these groups. When group 1 to 8 or 9 to 16 is selected, 03D faders correspond to parts 1 to 16, and when an 03D fader in group 1 to 8 or group 9 to 16 is operated, the corresponding group is selected on the display. When group 17 to 24 or 25 to 32 is selected, 03D faders correspond to parts 17 to 32, and when an 03D fader in group 17 to 24 or group 25 to 32 is operated, the corresponding group is selected on the display.

To adjust the reverb, chorus, expression, or pan of a part on the XG tone generator, or the reverb return, chorus return, variation return, or Master volume, select a control on the display and use the PARAMETER wheel. The corresponding parameter on the tone generator changes.

The Connect function can be used to update the 03D's faders and display controls when the XG tone generator is first connected, turned on, or a parameter is edited manually. To execute the Connect function, select the CONNECT button, and then press the [ENTER] button.

If the variation effect on the tone generator is set to Insertion, there will be a switch that specifies the part to which it will be assigned.

Pro Tools Page

The following table lists the Pro Tools parameters that can be controlled from the 03D. MIDI Channels do not have to be set.

03D Control	Pro Tools Parameter
Channel faders (1–8)	Track levels
[ON] buttons	Depends on the selected mode
Display functions	Start, Stop, Record, Fast Forward, Rewind
	Locate point recall
	Pan
	Send 1, Send 2

1. Use the [MIDI REMOTE] button to locate the Pro Tools page.

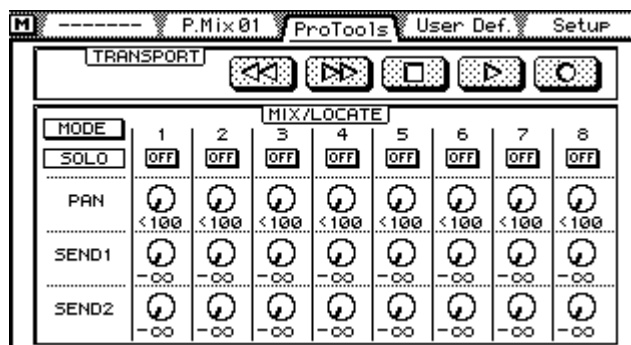

2. In Pro Tools, choose Peripherals from the Setups menu.
3. Turn on DEVICE CS-10.

03D channel faders 1 to 8 correspond to tracks 1 to 8 on Pro Tools. Adjusting an 03D fader changes the corresponding level in Pro Tools.

The Pro Tools transport functions can be controlled using the Rewind, Fast Forward, Stop, Play, and Record switches. For recording, make sure that Pro Tools is set to Record Enable.

Operation of the controls depends on the mode, as explained in the following table.

Mode	Operation
SOLO	ON/OFF switches are used to solo Pro Tools' tracks
MUTE	ON/OFF switches are used to mute Pro Tools' tracks
LOCATE	ON/OFF switches are used to move to the locate points set in Pro Tools
KNOB	The PAN, SEND1, and SEND2 controls can be used (note that these controls can only be operated in KNOB mode)

To adjust the pan, send 1, or send 2 of a Pro Tools track, set the mode to KNOB, select a control, and then use the PARAMETER wheel. The corresponding parameter changes in Pro Tools.

Do not operate the transport controls on both the 03D and Pro Tools.

User Define Page

The following table lists the 03D controls that can be used to control user-defined parameters.

03D Control	Parameter
Channel faders	Output a user-defined command (31 byte)
[ON] buttons (OFF to ON)	Output a user-defined command (16 byte)
[ON] buttons (ON to OFF)	Output a user-defined command (16 byte)

1. Use the [MIDI REMOTE] button to locate the User Def. page.

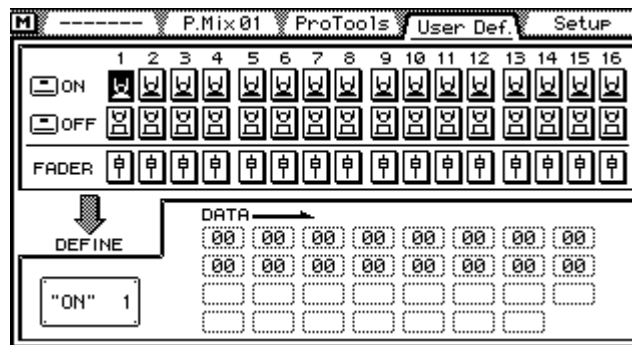

On the User Define page, you define the MIDI commands to be sent when the 03D's faders or [ON] buttons are operated. Two commands can be defined for the [ON] buttons. One for the transition from OFF to ON, and one for ON to OFF.

The following values can be set.

Hex: 00–EE, F0, F1, F2, F3, F6, F7, F8, FA, FB, FC, FF

FAD: Outputs the fader value (00–7F)

END: Completes the command

Troubleshooting

Symptom	Advice
The 03D cannot be turned on!	Make sure that the power cord is connected to a suitable AC wall outlet.
	Make sure that the 03D POWER switch is set to the ON position.
	If you still cannot turn on the 03D, contact your Yamaha dealer.
Input channel signal level is very low!	Make sure that the GAIN control and PAD switch (channels 1 to 8) are set correctly. See Gain and Pad on page 37.
	Use the Meter pages to check the levels. See Metering on page 79 for more information.
The faders do not adjust levels as expected!	Make sure that you have selected the correct fader mode and mixing layer, and that the MIDI Remote function is turned off. See Mixing Layer on page 31 for more information.
[ON] buttons and [SEL] buttons select the wrong channels!	Make sure that you have selected the correct mixing layer. See Mixing Layer on page 31 for more information.
Input signals are present but the display meters show nothing!	Make sure the Meter mode is not set to GAIN REDUCTION, which display the amount of gain reduction by the dynamics processors. See Metering on page 79 for more information.
Input signals are present but the stereo output is dead!	Raise the ST OUT fader and make sure that the ST OUT [ON] button is on. Make sure that the channels are routed to the stereo output. See Stereo Pan, Balance & Routing on page 59 for more information.
Input signals are present but the monitor output is dead!	Make sure that the MONITOR OUT SOLO/2TR IN switch is set to SOLO. See Two-track Input on page 77 for more information.
	Make sure that the MONITOR OUT control is turned up, and that on the Moni.Setup page the MONI TRIM control is turned up and a monitor source is selected. See Monitoring on page 74 for more information.
Solo mode is selected but nothing can be heard!	Make sure that the MONITOR OUT SOLO/2TR IN switch is set to SOLO. See Two-track Input on page 77 for more information.
	Make sure that the MONITOR OUT control is turned up, and that on the Solo Setup page the SOLO TRIM control is turned up. See Using Solo on page 76 for more information.
In Mixdown Solo mode, some channels are heard all the time!	Are these channels set as solo safe channels? See Solo Safe on page 77 for more information.
Signals from input channels 1 and 2 cannot be heard!	Is there an external processor that is turned off connected to the insert jacks?
Channels seem to run out of headroom, especially when EQ boost is applied!	Use the Attenuator function on the EQ page to reduce the level. See Attenuator on page 38 for more information.
A signal is connected to the ST IN analog input jacks but it doesn't appear on the ST IN channel!	Make sure the input source for the ST IN is set to ANALOG on the D.in Setup page. See Digital Stereo In on page 221 for more information.
An AES/EBU signal is connected to the DIGITAL STEREO IN connection but cannot be heard!	Make sure that DIGITAL STEREO IN is set to AES/EBU, and that the DIGITAL STEREO IN signal is routed to either the ST IN channel or STEREO CASCADE, and that the CASCADE is turned ON. All these settings are made on the on the D.in Setup page. See Digital Stereo In on page 221 for more information.
Recordings made via the DIGITAL ST OUT or YGDAI sound grainy!	Make sure that the Dither function is set to match the wordlength of the recording device. See Output Dither on page 220 for more information.
Signals connected via the DIGITAL ST IN or YGDAI sound noisy!	Make sure that the device sending these signals is synchronized to the master wordclock. See Wordclock Setup on page 216 for more information.

Symptom	Advice
Configured a stereo pair but the signal appears to be in mono!	Make sure that the odd channel is panned hard left, and the right channel is panned hard right.
Configured a stereo pair but the signal sounds out of phase!	Make sure that the phase of both input channels in the stereo pair is set the same. Phase settings are not linked when channels are configured as a stereo pair. See Phase on page 39 for more information.
Signals appeared to be delayed!	Make sure that the Channel Delay function is set correctly. See Channel Delay on page 40 for more information.
Added faders to a fader group but grouping does not work!	Make sure that the fader group is enabled. See Fader Groups on page 112 for more information.
Added channels to a mute group but group muting does not work!	Make sure that the mute group is enabled. See Mute Groups on page 113 for more information.
Cannot recall effects programs 43, or 64 to Effect 1!	These effects programs use the HQ. PITCH and FREEZE type effects, and can be recalled only to Effect 2.
Cannot access the Bus To ST page!	Make sure the Pan mode is set to Stereo. When a surround pan mode is selected this page cannot be accessed. See Selecting a Pan Mode on page 58 for more information.
Cannot recall a channel program!	Does the program contain data that corresponds to the selected channel? See Recalling Channel Programs on page 106 for more information.
Cannot store a mix scene!	Is the selected scene memory protected? See Write Protecting Scene Memories on page 170 for more information.
Recalling a mix scene doesn't update some channels!	Are those channels set as safe channels? See Recalling Scene Data Safely on page 174 for more information.
Cannot recall mix scenes using MIDI Program Change messages!	Make sure that the 03D is configured to receive Program Change messages and the MIDI Channels match. See MIDI Setup on page 235 for more information.
	Check the mix scene to Program Change assign table. See Program Change Assign on page 239 for more information.
Cannot control mix parameters using MIDI Control Change messages!	Make sure that the 03D is configured to receive Control Change messages and that the MIDI Channels match. See MIDI Setup on page 235 for more information.
	Check the parameter to Control Change assign table. See Control Change Assign on page 240 for more information.
Automix cannot record!	Make sure that the Automix function is enabled. See Enabling Automix on page 180 for more information.
Some channels do not respond to automix recording and playback!	Are these channels set as safe channels? See Safe Channels on page 183 for more information.
Fader movement is not consistent!	Calibrate the faders. See Calibrating the Faders on page 214 for more information.

Appendix A: General

03D Level Diagram

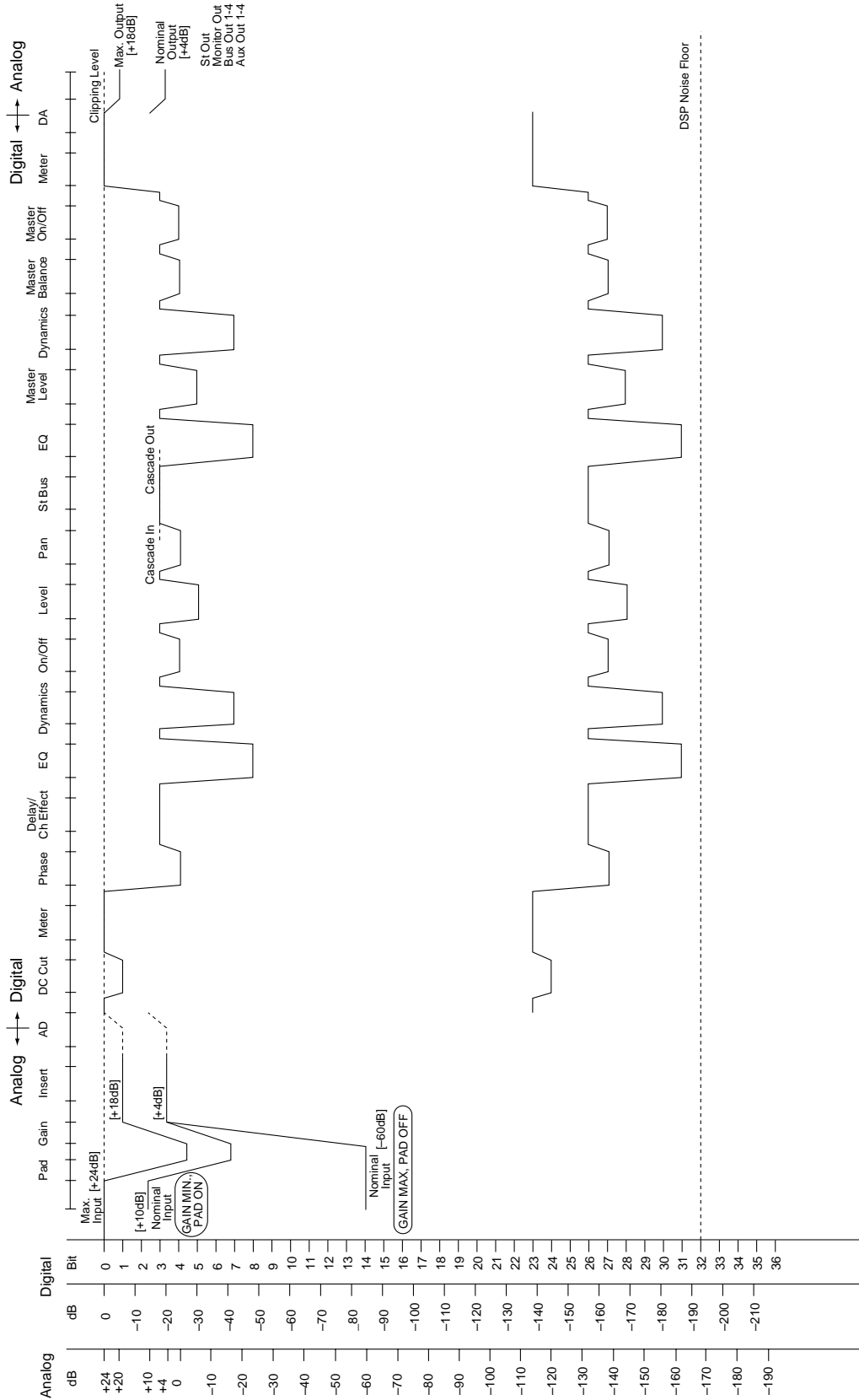

Display Messages

Message	Meaning
AUTOMIX MEMORY FULL!	The automix memory is full. Delete some unnecessary data or back up your data to a MIDI data filer.
AUTOMIX REC ABORTED.	Automix recording was aborted and the data was discarded. If the automix undo buffer is set to ENABLE, you can undo the operation.
AUTOMIX REC STOPPED!	Automix recording was stopped.
AUTOMIX REC TIME EXCEEDED!	The total recording time for automix has been exceeded.
AUTOMIX RUNNING.	Cannot operate while automix is recording or playing.
BULK: AUTOMIX MEMORY FULL!	The received Bulk Dump data cannot be stored because the automix memory is full.
BULK: BYTE COUNT MISMATCH!	The byte count of the received Bulk Dump data is not correct.
BULK: CHECK SUM MISMATCH!	The check sum of the received Bulk Dump data is not correct.
BULK: MEMORY PROTECTED!	The Bulk Dump data cannot be stored because the destination is write-protected.
CANNOT CONNECT!	Connection could not be made with the device selected on the MIDI REMOTE page. Check the port setting and connections.
CANNOT EXECUTE (NO DATA).	Cannot execute as no data has been stored.
CH17–24 ARE DISABLED!	When a CD8-CS cascade card is installed in the YGDAI slot, input channels 17–24 are disabled.
DIGITAL ST IN SYNC ERROR!	The digital audio signal connected via the DIGITAL ST IN connector is not synchronized with the wordclock master. This may cause noise. Make sure that the device feeding the DIGITAL ST IN is synchronized to the master wordclock or make the DIGITAL ST IN the wordclock source. This message can be disabled by setting the DIGITAL ST IN SYNC CAUTION preference to OFF on the Prefer. page of the UTILITY function.
FOR EFFECT1 ONLY.	The selected effect program can be recalled only to Effect 1.
LOW BATTERY!!	The internal battery voltage is getting very low. Back up the setup data (<i>Bulk Dump</i> on page 242), and ask your dealer to replace the battery.
MIDI IN: DATA FRAMING ERROR!	An incorrect signal may have been input to the MIDI IN.
MIDI IN: DATA OVERRUN!	An incorrect signal may have been input to the MIDI IN.
MIDI: Rx BUFFER FULL!	The 03D is probably receiving too much MIDI data.
MIDI: Tx BUFFER FULL!	The 03D is probably transmitting too much MIDI data.
NO DATA TO RECALL.	Cannot recall as no data has been stored.
RECALL SAFE DATA CONFLICT!	Some channels are protected by the scene memory recall safe function. However, the memory you are trying to recall has different bus and aux pair settings and pan mode (stereo/surround) settings, so the scene recall could not be executed.
SOLO READY.	Solo mode is active. Use the [SEL] buttons to solo channels.
SOLO SLAVE.	When the 03D is configured as cascade slave, you cannot change the solo status. Use the [SOLO] button on the cascade master.
TC FRAME JUMP!	The timecode being received is jumping and dropping frames. Check the device outputting the timecode.

Message	Meaning
TC TYPE MISMATCH!	Timecode that is different from the automix Time Base setting has been input. The automix may not play back correctly. Review and correct the setting.
TO HOST: DATA FRAMING ERROR!	An incorrect signal may have been input to the TO HOST connector.
TO HOST: DATA OVERRUN!	An incorrect signal may have been input to the TO HOST connector.
TO HOST: DATA PARITY ERROR!	An incorrect signal may have been input to the TO HOST connector.
TO HOST: RX BUFFER FULL!	The 03D is probably receiving too much MIDI data at the TO HOST connector.
TO HOST: TX BUFFER FULL!	The 03D is probably transmitting too much MIDI data from the TO HOST connector.
WRONG WORD CLOCK!	The received wordclock is not correct and the 03D cannot synchronize correctly. Select an appropriate wordclock by reviewing the system connections, or use the AUTO NAVIGATE function on the D.in Setup page of the DIO function.
YGDAL INPUT SYNC ERROR!	The digital audio signal connected via the YGDAL card is not synchronized with the wordclock master. This may cause noise. Make sure that the device feeding the YGDAL card inputs is synchronized to the master wordclock. Even if the sync system is correctly configured, the wordclock may become unstable until the digital MTR enters chase mode, and this message may appear. This message can be disabled by setting the YGDAL IN SYNC CAUTION preference to OFF on the Prefer. page of the UTILITY function.

Security Cover

In some situations you may want to fit a protective cover over the analog controls across the top of the 03D. Although Yamaha do not make a cover, the 03D has four fixing holes to secure a user-made cover. If you fit such a cover, make sure that the fixing screws do not protrude inside the 03D by more than 12 mm. The fixing holes accept M3-size machine screws, and are spaced 40.0 mm vertically, 411.6 mm horizontally.

Rack-mounting Kit

The 03D can be rack mounted using the optional RK124 Rack Mount Kit. See your Yamaha dealer for details.

Fitting Instructions

1. **Undo the screws shown here and remove the side panels.**

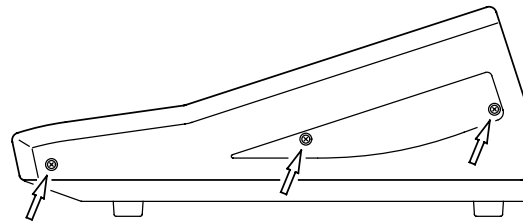

2. **Attach the rack-mount brackets as shown here.**

Here the bracket is fitted so that the 03D's display and buttons are flush with the front of the rack.

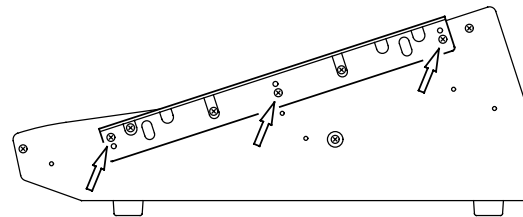

Here the bracket is fitted so that the 03D's faders are flush with the front of the rack.

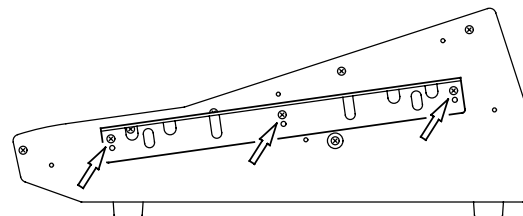

03D VEK (Video Edit Suite Software)

With support for the ESAM II editor protocol, the optional 03D Video Edit Suite software turns the 03D Digital Mixing Console into a full-feature digital audio mixer for video post-pro. With the Video Edit Suite Software installed and enabled, audio signals can be mixed and edited along with video. ESAM II support means that the 03D works like a video switcher for audio, allowing remote transition previews from a video editor. Several extended functions of the ESAM II protocol including remote fader level control have been employed. 03D data can be downloaded or uploaded to a video editor for centralized data management. The 03D's motorized faders allow for accurate level adjustments, and precisely reflect input level settings. In FROM-TO mode, faders reflect transition levels. The 03D does not require extra hardware to the Video Edit Suite Software. A video editor can be connected directly to the 03D's TO EDITOR port.

Appendix B: Specifications

General Specs

Sampling rate	Internal: 48 kHz/44.1 kHz External: 32 kHz (–6%) to 48 kHz (+6%)
Signal delay	Less than 2.5 ms $f_s=48$ kHz, CH IN to ST OUT
Dither	16 to 24 bit
Fader	60 mm stroke motorized fader \times 19
Fader resolution	128 steps ST OUT: +6 to –90 dB, $-\infty$ dB others: +6 to –72 dB, $-\infty$ dB
Total harmonic distortion (THD)	Less than 0.1% 20 Hz to 20 kHz, +14 dB 600 Ω , ST IN to ST OUT Less than 0.02% 1 kHz, +18 dB 600 Ω , ST IN to ST OUT
Frequency response	20 Hz to 20 kHz +1, –3 dB, +4 dB 600 Ω
Dynamic range	110 dB typical DA (ST OUT) 105 dB typical AD+DA (ST IN to ST OUT)
Hum & Noise	
20 Hz to 20 kHz, $R_s=150\Omega$, GAIN: Max, PAD: off, Input sensitivity=–60 dB LPF (Measured with a –6 dB/octave filter @12.7 kHz; equivalent to a 20 kHz filter with an infinite dB/octave attenuation.)	–128 dB Equivalent input noise –94 dB Residual noise ST OUT, ST OUT ON switch: off –94 dB 98 dB S/N all channel faders: $-\infty$ dB ST OUT fader: 0 dB –64 dB 68 dB S/N 1 channel fader: 0 dB ST OUT fader: 0 dB
Maximum voltage gain	76 dB CH IN to ST OUT/BUS OUT 76 dB CH IN (Pre-fader) to AUX OUT 36 dB ST IN to ST OUT 76 dB CH IN to MONITOR OUT (ST OUT via pre-fader)
Crosstalk (1 kHz)	–70 dB adjacent input channels –60 dB adjacent ST IN –70 dB CH IN to output
Controls	
Analog section	
PAD switch	26 dB input channels 1 to 8
GAIN control	44 dB (–16 to –60 dB) input channels 1 to 8 30 dB (+10 to –20 dB) input channels 9 to 16, ST IN
PHANTOM switch	+48V input channels 1 to 8
Monitor output switch	SOLO/2TR IN
LEVEL controls	MONITOR OUT, PHONES
Digital section	
ON button, SEL button, fader	channels 1 to 16 (17 to 24, AUX 1 to 4, BUS 1 to 4), ST IN, RETURN 1/2, ST OUT
MIXING LAYER button	channel 1 to 16 (17 to 24/MASTER)
MIDI REMOTE button	Remote/Local off
FADER MODE button	AUX1, AUX2, AUX3, AUX4, FADER-METER, EFFECT1, EFFECT2

CHANNEL CONTROL button	EQ LOW, LO-MID, HI-MID, HIGH, DELAY/Ø, DYNAMICS, PAN/ROUTING, VIEW
SET UP button	UTILITY, MIDI, SCENE MEMORY, DIO, GROUP/PAIR, SOLO SETUP, AUTOMIX
SOLO button	
SCENE MEMORY button	STORE, RECALL, INC+, DEC-, UNDO/REDO
USER DEFINE button	1, 2, 3, 4
CURSOR button	LEFT, RIGHT, UP, DOWN
PARAMETER wheel	24-click rotary encoder
ENTER button	
Display	
LCD	Graphical LCD, 320 × 240 dots with backlight and contrast control
Meters	STEREO OUT meter, 2 × 12 segment LED bargraphs
LED indicators	MIXING LAYER 1–16/(17–24/MASTER) EFFECT RETURN 1/2
Power Requirements	
	U.S.A. & Canada 120 V AC, 60 Hz European 230 V AC, 50 Hz
Power Consumption	85 W
Dimensions (W × H × D)	460 × 210.5 × 516.5 mm (18.1" × 8.3" × 20.3")
Weight	16 kg (35.3 lbs)
Free-air operating temperature range	10°C to 35°C (50°F to 95°F)
Security cover	Four M3 fixing holes for user-made cover
Options	YGDAL cards, RK124 Rack Mount Kit, 03D VEK (Video Edit Suit Software)

Channel Specs

Mono input channel	channels 1 to 24 (channels 17 to 24: YGDAI card)
Analog section	
PHANTOM switch	+48 V, CH 1 to 8
GAIN control	44 dB (–16 to –60 dB), channel 1 to 8 30 dB (+10 to –20 dB), channel 9 to 16
PAD switch	26 dB, channels 1 to 8
INSERT	channel 1 & 2
AD convertor	20-bit linear 64-times oversampling
Digital section	
Attenuator	0 to –96 dB 1 dB step
Delay	Delay/Slap/Echo (Delay time: 0 to 200 ms, fs=48 kHz)
Pre/Post	AUX1, AUX2, AUX3, AUX4, EFFECT1, EFFECT2
Phase	Normal/Reverse
Equalizer	4-band parametric equalizer
Dynamics	
ON button	ON/OFF CH 1 to 16
Fader	60 mm stroke motorized fader CH 1 to 16
Solo	ON/OFF AFL/PFL
Pan	
Bus assign	BUS1, BUS2, BUS3, BUS4, STL-R Direct out (channel 1 to 16: YGDAI)
Meter	LCD
Stereo input channel L-R	
Analog section	
GAIN control	30 dB (+10 to –20 dB)
AD convertor	20-bit linear 64-times oversampling
Digital section	
FLIP switch	Normal (ST IN: Analog) FLIP (DIGITAL STEREO IN: Digital)
Attenuator	0 to –96 dB 1 dB step
Delay	Delay/Slap/Echo (Delay time: 0 to 200 ms, fs=48 kHz)
Equalizer	4-band parametric equalizer
Dynamics	
ON button	ON/OFF
Fader	60 mm stroke motorized fader
Solo	ON/OFF AFL/PFL
Balance	
Dual pan	Individual/Gang/Inverted Gang
Bus assign	BUS 1, BUS 2, BUS 3, BUS 4, ST L-R
Meter	LCD
Pre/Post	AUX1, AUX2, AUX3, AUX4, EFFECT1, EFFECT2

Stereo digital input channel

De-emphasis	Auto de-emphasis filter (15 μ s/50 μ s)
FLIP switch	Normal (ST IN: analog) FLIP (DIGITAL STEREO IN: digital) DIGITAL STEREO IN: AES/EBU, COAXIAL
Cascade	ON/OFF, ON: assign to ST bus

Effect return channel 1,2

Equalizer	4-band parametric equalizer
Dynamics	
ON button	ON/OFF EFFECT1, EFFECT2
Fader	60 mm stroke motorized fader
Solo	ON/OFF AFL/PFL
Balance	
Dual pan	Individual/Gang/Inverted Gang
Bus assign	BUS1, BUS2, BUS3, BUS4, ST L-R
Meter	LCD
Pre/Post	AUX1, AUX2, AUX3, AUX4

Stereo output channel L-R**Digital section**

Equalizer	4-band parametric equalizer
Fader	60 mm stroke motorized fader
Balance	
Dynamics	
ON button	ON/OFF
Delay	Delay time: 0 to 41.7 ms, fs=48 kHz
Monitor	ON/OFF AFL/PFL
Meter	12-element LED Meter \times 2 (Post-fader)

Analog section

DA convertor	20-bit linear 8-times oversampling
--------------	------------------------------------

BUS Output channel BUS OUT 1 to 4**Digital section**

Equalizer	4-band parametric equalizer
Pan (to ST BUS)	
Fader	60 mm stroke motorized fader
Monitor	ON/OFF AFL/PFL
Meter	LED
Delay	Delay time: 0 to 41.7 ms, fs=48 kHz

Analog section

DA convertor	18-bit linear 8-times oversampling
--------------	------------------------------------

AUX output channel AUX OUT 1 to 4**Digital section**

Equalizer	4-band parametric equalizer
Fader	60 mm stroke motorized fader
Dynamics	
ON/OFF	
Monitor	ON/OFF AFL/PFL
Meter	LCD

Analog section

DA convertor	18-bit linear 8-times oversampling
--------------	------------------------------------

Monitor output channel**Digital section**

MONI TRIM control/SOLO TRIM control (SOLO ON)	
MONO switch	ON/OFF

Analog section

DA convertor	20-bit linear 8-times oversampling
Output select switch	SOLO/2TR IN
LEVEL control	MONITOR OUT PHONES

REC OUT channel

SOURCE SELECT switch	ST OUT/BUS 1-2
----------------------	----------------

Digital stereo output channel

Dither	Word length: 16 to 24 bit
--------	---------------------------

Digital output channel (YGDAI cards)

Output select	BUS 1/CH 1/CH 9/AUX 1/ST OUT L to YGDAI OUTPUT 1 BUS 2/CH 2/CH 10/AUX 2/ST OUT R to YGDAI OUTPUT 2 BUS 3/CH 3/CH 11/AUX 3/ST OUT L to YGDAI OUTPUT 3 BUS 4/CH 4/CH 12/AUX 4/ST OUT R to YGDAI OUTPUT 4 BUS 1/CH 5/CH 13/AUX 1/ST OUT L to YGDAI OUTPUT 5 BUS 2/CH 6/CH 14/AUX 2/ST OUT R to YGDAI OUTPUT 6 BUS 3/CH 7/CH 15/AUX 3/ST OUT L to YGDAI OUTPUT 7 BUS 4/CH 8/CH 16/AUX 4/ST OUT R to YGDAI OUTPUT 8
Dither	Word length: 16 to 24 bit

Memory/Library Specs

Type	Total	Preset	User
Scene Memories	51	1	50
Channel Library	51	2	49
Effects Library	96	64	32
Dynamics Library	80	40	40
EQ Library	80	40	40

EQ Specs

Band	(G)ain	(F)requency ¹	(Q)
High	±18 dB	21 Hz–20.1 kHz	LPF, 10–0.1, shelving
High-Mid	±18 dB	21 Hz–20.1 kHz	10–0.1
Lo-Mid	±18 dB	21 Hz–20.1 kHz	10–0.1
Low	±18 dB	21 Hz–20.1 kHz	HPF, 10–0.1, shelving

1. Frequency at 48 kHz or 44.1 kHz sampling rate. At a sampling rate of 32 kHz the frequency range is 21 Hz–15.1 kHz.

Analog Inputs Specs

Connection	PAD Switch	GAIN Control	Actual Load Impedance	For Use With Nominal	Sensitivity ¹	Input level		Connector
						Nominal	Maximum Before Clipping	
Input Channels 1–8	OFF	–60	3 k Ω	50–600 Ω Mics & 600 Ω Lines	–72 dB (194 μ V)	–60 dB (775 μ V)	–46 dB (3.88 mV)	XLR-3-31 type (balanced) ² & TRS phone jack (balanced) ³
	OFF	–16			–28 dB (30.9 mV)	–16 dB (123 mV)	–2 dB (616 mV)	
	ON				–2 dB (616 mV)	+10 dB (2.45 V)	+24 dB (12.3 V)	
Input Channels 9–16	—	–20	10 k Ω	600 Ω Lines	–32 dB (19.4 mV)	–20 dB (77.5 mV)	–6 dB (388 mV)	TRS phone jack (balanced) ³
		+10			–2 dB (616 mV)	+10 dB (2.45 V)	+24 dB (12.3 V)	
ST IN (L, R)	—	–20	10 k Ω	600 Ω Lines	–32 dB (19.4 mV)	–20 dB (77.5 mV)	–6 dB (388 mV)	TRS phone jack (balanced) ³
		+10			–2 dB (616 mV)	+10 dB (2.45 V)	+24 dB (12.3 V)	
Insert In (CH1, 2)	—	—	10 k Ω	600 Ω Lines	–8 dB (309 mV)	+4 dB (1.23 V)	+18 dB (6.16 V)	TRS phone jack (unbalanced) ⁴
2TR IN (L, R)	—	—	10 k Ω	600 Ω Lines	–10 dBV (316 mV)	–10 dBV (316 mV)	+4 dBV (1.58 V)	Phono (unbalanced)

1. Sensitivity is the lowest level that will produce an output of +4 dB (1.23 V) or the nominal output level when the 03D is set to maximum gain (all faders and level controls at maximum positions).
2. Input channel XLR-type connectors are balanced (pin 1 = ground, pin 2 = hot, pin 3 = cold).
3. Input channel and ST input TRS phone jacks are balanced (tip = hot, ring = cold, sleeve = ground).
4. Input channel insert connections are unbalanced (tip = send, ring = return, sleeve = ground).
5. When dB represents a specific voltage, 0 dB is referenced to 0.775 V rms.
6. For 2TR IN levels, 0 dBV is referenced to 1.00 V rms.
7. Input channels 1–16 and ST IN use linear 20-bit 64-times oversampling A/D converters.
8. Individually switched +48 V phantom power is available on input channels 1–8.

Analog Outputs Specs

Connection	Actual Source Impedance	For Use With Nominal	Output Level		Connector
			Nominal	Maximum Before Clipping	
STEREO OUT (L, R)	150 Ω	600 Ω Lines	+4 dB (1.23 V)	+18 dB (6.16 V)	XLR-3-32 type (balanced) ¹
BUS OUT (1–4)	150 Ω	10 k Ω Lines	+4 dB (1.23 V)	+18 dB (6.16 V)	TRS phone jack (balanced) ²
AUX OUT (1–4)	150 Ω	10 k Ω Lines	+4 dB (1.23 V)	+18 dB (6.16 V)	TRS phone jack (balanced) ²
Insert Out (CH1, 2)	600 Ω	10 k Ω Lines	+4 dB (1.23 V)	+18 dB (6.16 V)	TRS phone jack (unbalanced) ³
REC OUT (L, R)	600 Ω	10 k Ω Lines	–10 dBV (316 mV)	+4 dBV (1.58 V)	Phono (unbalanced)
MONITOR OUT (L, R)	150 Ω	10 k Ω Lines	+4 dB (1.23 V)	+18 dB (6.16 V)	TRS phone jack (balanced) ²
Phones	100 Ω	8 Ω phones	1 mW	25 mW	Stereo phone jack (unbalanced) ⁴
		40 Ω phones	3 mW	75 mW	

1. STEREO OUT XLR-type connectors are balanced (pin 1 = ground, pin 2 = hot, pin 3 = cold).
2. BUS, AUX, and MONITOR OUT TRS phone jacks are balanced (tip = hot, ring = cold, sleeve = ground).
3. Input channel insert connections are unbalanced (tip = send, ring = return, sleeve = ground).
4. The PHONES stereo phone jack is unbalanced (tip = left, ring = right, sleeve = ground).
5. When dB represents a specific voltage, 0 dB is referenced to 0.775 V rms.
6. For REC OUT levels, 0 dBV is referenced to 1.00 V rms.
7. STEREO OUT and MONITOR OUT use 20-bit 8-times oversampling D/A converters.
8. BUS and AUX outputs use 18-bit 8-times oversampling D/A converters.

Digital Inputs Specs

Connection		Format	Data Length	Level	Connector
DIGITAL STEREO IN ¹	AES/EBU	AES/EBU	24 bit	RS-422	XLR-3-31 type
	COAXIAL	IEC-958 Consumer Use	24 bit	0.5 Vpp (75Ω)	Phono

1. De-emphasis is applied automatically if the input signal has been emphasized.

Digital Outputs Specs

Connection		Format	Data Length	Level	Connector
DIGITAL STEREO OUT	AES/EBU	AES/EBU ¹	24 bit ³	RS-422	XLR-3-32 type
	COAXIAL	IEC-958 ² Consumer Use	20 bit ³	0.5 Vpp (75Ω)	Phono

1. Channel status
Type: 2 channel audio signal
Emphasis: No
Sampling rate: depends on internal configuration
2. Channel status
Type: 2 channel audio signal
Category code: 2 channel PCM encoder/decoder
Copy prohibit: No
Emphasis: No
Clock accuracy: Level II (1,000 ppm)
Sampling rate: depends on internal configuration
3. Dither: wordlength 16–24 bit

YGDAI Interface Card Specs

Card	Format	Inputs	Outputs
CD8-AT	ADAT	8 inputs (CH17–24)	8 outputs (BUS, AUX, ST, CH direct)
CD8-TDII	TASCAM	8 inputs (CH17–24)	8 outputs (BUS, AUX, ST, CH direct)
CD8-AE-S	AES/EBU	8 inputs (CH17–24)	8 outputs (BUS, AUX, ST, CH direct)
CD8-Y	Yamaha	8 inputs (CH17–24)	8 outputs (BUS, AUX, ST, CH direct)
CD8-CS	Cascade	Cascade inputs	Cascade outputs

Control I/O Specs

Connection	Format	Level	Connector
TO HOST ¹	—	—	8-pin mini DIN
MIDI IN (MTC)	MIDI	—	5-pin DIN
MIDI THRU	MIDI	—	5-pin DIN
MIDI OUT	MIDI	—	5-pin DIN
MOUSE	—	—	9-pin D-sub (male)
TO EDITOR ¹	—	RS-422	9-pin D-sub (female)
WORD CLOCK IN	—	TTL (75Ω ON/OFF)	BNC
WORD CLOCK OUT	—	TTL (75Ω)	BNC

1. TO HOST and TO EDITOR cannot be used at the same time.

03D Dimensions

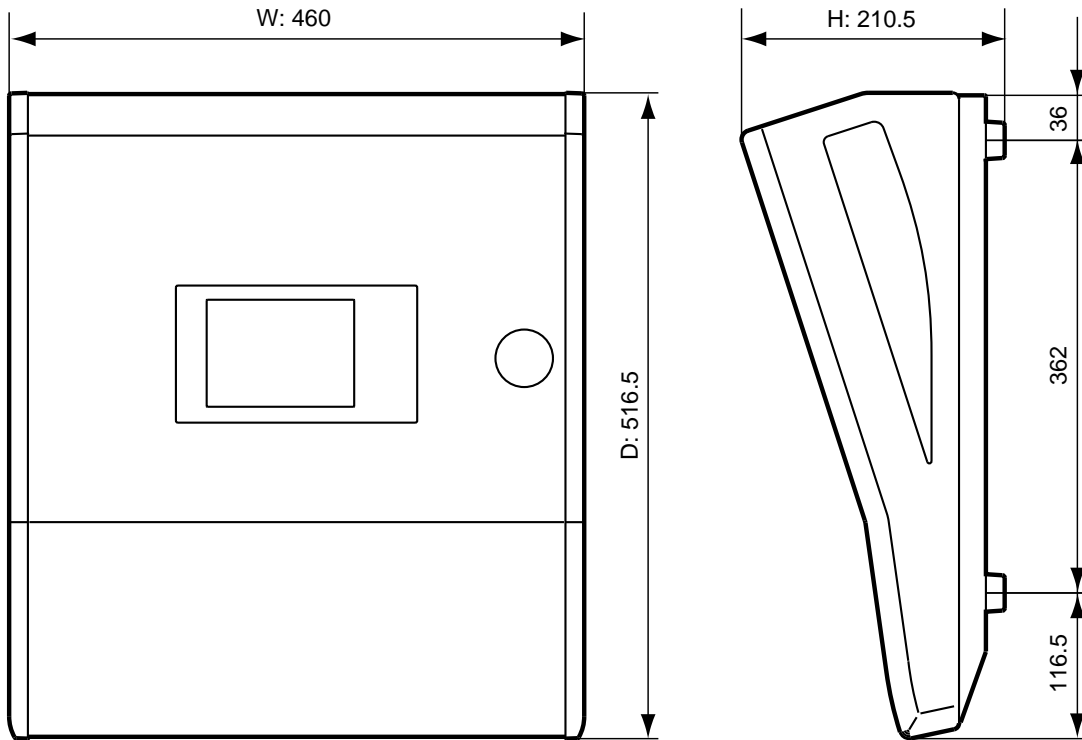

Specifications and external appearance are subject to change without notice.

For European Model

Purchaser/User information specified in EN55103-1 and EN55103-2.

Inrush Current: 5A

Conformed Environment: E1, E2, E3 and E4.

Appendix C: MIDI

Scene Memory to Program Change Table

Program Change #	Initial Scene #	User Scene #
1	01	
2	02	
3	03	
4	04	
5	05	
6	06	
7	07	
8	08	
9	09	
10	10	
11	11	
12	12	
13	13	
14	14	
15	15	
16	16	
17	17	
18	18	
19	19	
20	20	
21	21	
22	22	
23	23	
24	24	
25	25	
26	26	
27	27	
28	28	
29	29	
30	30	
31	31	
32	32	
33	33	
34	34	
35	35	
36	36	
37	37	
38	38	
39	39	
40	40	
41	41	
42	42	
43	43	

Program Change #	Initial Scene #	User Scene #
44	44	
45	45	
46	46	
47	47	
48	48	
49	49	
50	50	
51	00	
52	—	
53	—	
54	—	
55	—	
56	—	
57	—	
58	—	
59	—	
60	—	
61	—	
62	—	
63	—	
64	—	
65	—	
66	—	
67	—	
68	—	
69	—	
70	—	
71	—	
72	—	
73	—	
74	—	
75	—	
76	—	
77	—	
78	—	
79	—	
80	—	
81	—	
82	—	
83	—	
84	—	
85	—	
86	—	

Program Change#	Initial Scene #	User Scene #
87	—	
88	—	
89	—	
90	—	
91	—	
92	—	
93	—	
94	—	
95	—	
96	—	
97	—	
98	—	
99	—	
100	—	
101	—	
102	—	
103	—	
104	—	
105	—	
106	—	
107	—	
108	—	
109	—	
110	—	
111	—	
112	—	
113	—	
114	—	
115	—	
116	—	
117	—	
118	—	
119	—	
120	—	
121	—	
122	—	
123	—	
124	—	
125	—	
126	—	
127	—	
128	—	

Parameter to Control Change Table

Control Change #	Parameter						
	03D Default			Programmable Mixer 01 Arrangement			User
0	NO ASSIGN			FADER	CHANNEL	CH 1	
1	FADER	CHANNEL	CH 1	FADER	CHANNEL	CH 2	
2	FADER	CHANNEL	CH 2	FADER	CHANNEL	CH 3	
3	FADER	CHANNEL	CH 3	FADER	CHANNEL	CH 4	
4	FADER	CHANNEL	CH 4	FADER	CHANNEL	CH 5	
5	FADER	CHANNEL	CH 5	FADER	CHANNEL	CH 6	
6	FADER	CHANNEL	CH 6	FADER	CHANNEL	CH 7	
7	FADER	CHANNEL	CH 7	FADER	CHANNEL	CH 8	
8	FADER	CHANNEL	CH 8	FADER	CHANNEL	CH 9	
9	FADER	CHANNEL	CH 9	FADER	CHANNEL	CH10	
10	FADER	CHANNEL	CH10	FADER	CHANNEL	CH11	
11	FADER	CHANNEL	CH11	FADER	CHANNEL	CH12	
12	FADER	CHANNEL	CH12	FADER	CHANNEL	CH13	
13	FADER	CHANNEL	CH13	FADER	CHANNEL	CH14	
14	FADER	CHANNEL	CH14	FADER	CHANNEL	CH15	
15	FADER	CHANNEL	CH15	FADER	CHANNEL	CH16	
16	FADER	CHANNEL	CH16	FADER	CHANNEL	ST IN	
17	FADER	CHANNEL	CH17	FADER	CHANNEL	RETURN1	
18	FADER	CHANNEL	CH18	FADER	CHANNEL	RETURN2	
19	FADER	CHANNEL	CH19	FADER	CHANNEL	MAS AUX1	
20	FADER	CHANNEL	CH20	FADER	CHANNEL	MAS AUX2	
21	FADER	CHANNEL	CH21	FADER	CHANNEL	MAS ST	
22	FADER	CHANNEL	CH22	ON	CHANNEL	CH 1	
23	FADER	CHANNEL	CH23	ON	CHANNEL	CH 2	
24	FADER	CHANNEL	CH24	ON	CHANNEL	CH 3	
25	FADER	CHANNEL	ST IN	ON	CHANNEL	CH 4	
26	FADER	CHANNEL	RETURN1	ON	CHANNEL	CH 5	
27	FADER	CHANNEL	RETURN2	ON	CHANNEL	CH 6	
28	FADER	CHANNEL	MAS AUX1	ON	CHANNEL	CH 7	
29	FADER	CHANNEL	MAS AUX2	ON	CHANNEL	CH 8	
30	FADER	CHANNEL	MAS AUX3	ON	CHANNEL	CH 9	
31	FADER	CHANNEL	MAS AUX4	ON	CHANNEL	CH10	
32	—			ON	CHANNEL	CH11	
33	FADER	CHANNEL	MAS BUS1	ON	CHANNEL	CH12	
34	FADER	CHANNEL	MAS BUS2	ON	CHANNEL	CH13	
35	FADER	CHANNEL	MAS BUS3	ON	CHANNEL	CH14	
36	FADER	CHANNEL	MAS BUS4	ON	CHANNEL	CH15	
37	FADER	CHANNEL	MAS ST	ON	CHANNEL	CH16	

Control Change #	Parameter						User		
	03D Default			Programmable Mixer 01 Arrangement					
38	PAN	CHANNEL	CH 1	ON	CHANNEL	ST IN			
39	PAN	CHANNEL	CH 2	ON	CHANNEL	RETURN1			
40	PAN	CHANNEL	CH 3	ON	CHANNEL	RETURN2			
41	PAN	CHANNEL	CH 4	ON	CHANNEL	MAS AUX1			
42	PAN	CHANNEL	CH 5	ON	CHANNEL	MAS AUX2			
43	PAN	CHANNEL	CH 6	ON	CHANNEL	MAS ST			
44	PAN	CHANNEL	CH 7	PAN	CHANNEL	CH 1			
45	PAN	CHANNEL	CH 8	PAN	CHANNEL	CH 2			
46	PAN	CHANNEL	CH 9	PAN	CHANNEL	CH 3			
47	PAN	CHANNEL	CH10	PAN	CHANNEL	CH 4			
48	PAN	CHANNEL	CH11	PAN	CHANNEL	CH 5			
49	PAN	CHANNEL	CH12	PAN	CHANNEL	CH 6			
50	PAN	CHANNEL	CH13	PAN	CHANNEL	CH 7			
51	PAN	CHANNEL	CH14	PAN	CHANNEL	CH 8			
52	PAN	CHANNEL	CH15	PAN	CHANNEL	CH 9			
53	PAN	CHANNEL	CH16	PAN	CHANNEL	CH10			
54	PAN	CHANNEL	CH17	PAN	CHANNEL	CH11			
55	PAN	CHANNEL	CH18	PAN	CHANNEL	CH12			
56	PAN	CHANNEL	CH19	PAN	CHANNEL	CH13			
57	PAN	CHANNEL	CH20	PAN	CHANNEL	CH14			
58	PAN	CHANNEL	CH21	PAN	CHANNEL	CH15			
59	PAN	CHANNEL	CH22	PAN	CHANNEL	CH16			
60	PAN	CHANNEL	CH23	PAN	CHANNEL	ST IN L			
61	PAN	CHANNEL	CH24	PAN	CHANNEL	ST IN R			
62	PAN	CHANNEL	ST IN L	PAN	CHANNEL	RETURN1L			
63	PAN	CHANNEL	ST IN R	PAN	CHANNEL	RETURN1R			
64	ON	CHANNEL	CH 1	PAN	CHANNEL	RETURN2L			
65	ON	CHANNEL	CH 2	PAN	CHANNEL	RETURN2R			
66	ON	CHANNEL	CH 3	NO ASSIGN					
67	ON	CHANNEL	CH 4	BALANCE		MAS ST			
68	ON	CHANNEL	CH 5	FADER	EFF1 SEND	CH 1			
69	ON	CHANNEL	CH 6	FADER	EFF1 SEND	CH 2			
70	ON	CHANNEL	CH 7	FADER	EFF1 SEND	CH 3			
71	ON	CHANNEL	CH 8	FADER	EFF1 SEND	CH 4			
72	ON	CHANNEL	CH 9	FADER	EFF1 SEND	CH 5			
73	ON	CHANNEL	CH10	FADER	EFF1 SEND	CH 6			
74	ON	CHANNEL	CH11	FADER	EFF1 SEND	CH 7			
75	ON	CHANNEL	CH12	FADER	EFF1 SEND	CH 8			
76	ON	CHANNEL	CH13	FADER	EFF1 SEND	CH 9			
77	ON	CHANNEL	CH14	FADER	EFF1 SEND	CH10			
78	ON	CHANNEL	CH15	FADER	EFF1 SEND	CH11			
79	ON	CHANNEL	CH16	FADER	EFF1 SEND	CH12			

Control Change #	Parameter									
	03D Default			Programmable Mixer 01 Arrangement			User			
80	ON	CHANNEL	CH17	FADER	EFF1 SEND	CH13				
81	ON	CHANNEL	CH18	FADER	EFF1 SEND	CH14				
82	ON	CHANNEL	CH19	FADER	EFF1 SEND	CH15				
83	ON	CHANNEL	CH20	FADER	EFF1 SEND	CH16				
84	ON	CHANNEL	CH21	FADER	EFF1 SEND	ST IN				
85	ON	CHANNEL	CH22	FADER	EFF2 SEND	CH 1				
86	ON	CHANNEL	CH23	FADER	EFF2 SEND	CH 2				
87	ON	CHANNEL	CH24	FADER	EFF2 SEND	CH 3				
88	ON	CHANNEL	ST IN	FADER	EFF2 SEND	CH 4				
89	ON	CHANNEL	RETURN1	FADER	EFF2 SEND	CH 5				
90	ON	CHANNEL	RETURN2	FADER	EFF2 SEND	CH 6				
91	ON	CHANNEL	MAS AUX1	FADER	EFF2 SEND	CH 7				
92	ON	CHANNEL	MAS AUX2	FADER	EFF2 SEND	CH 8				
93	ON	CHANNEL	MAS AUX3	FADER	EFF2 SEND	CH 9				
94	ON	CHANNEL	MAS AUX4	FADER	EFF2 SEND	CH10				
95	ON	CHANNEL	MAS ST	FADER	EFF2 SEND	CH11				
102	FADER	EFF1 SEND	CH 1							
103	FADER	EFF1 SEND	CH 2							
104	FADER	EFF1 SEND	CH 3							
105	FADER	EFF1 SEND	CH 4							
106	FADER	EFF1 SEND	CH 5							
107	FADER	EFF1 SEND	CH 6							
108	FADER	EFF1 SEND	CH 7							
109	FADER	EFF1 SEND	CH 8							
110	FADER	EFF1 SEND	CH 9		—					
111	FADER	EFF1 SEND	CH10							
112	FADER	EFF1 SEND	CH11							
113	FADER	EFF1 SEND	CH12							
114	FADER	EFF1 SEND	CH13							
115	FADER	EFF1 SEND	CH14							
116	FADER	EFF1 SEND	CH15							
117	FADER	EFF1 SEND	CH16							
118	FADER	EFF1 SEND	ST IN							
119	FADER	EFF1 SEND	MAS ST							

MIDI Data Format

1 Transmit/Receive Data

1.1 Channel Messages

1.1.1 Note On/ Note Off

When FADER START is on, Note-on messages will be transmitted when odd numbered faders from 1 through 15 are raised from -infinity (velocity 127) or lowered to -infinity (velocity 0).

CH	Note No.
1	37 (25h)
3	38 (26h)
5	39 (27h)
7	40 (28h)
9	41 (29h)
11	42 (2Ah)
13	43 (2Bh)
15	44 (2Ch)

Also, Note-on/off messages are received when the Effect is being frozen and MIDI TRG is not set to OFF. In this case, the velocity is ignored.

1.1.2 Control Changes

Control change messages will be transmitted or received when transmission or reception are respectively turned on.

With a setting of OMNI, all channels will be received.

The 114 control numbers 0 through 95 and 102 through 119 can be freely assigned to mixer parameters.

Note: 0 and 32 are Bank Change messages, and in the case of a device which cannot transmit or receive these correctly unless they are used in conjunction with a Program Change message, it is possible that there will be problems with operation. In this case, do not assign 0 or 32.

Data values for transmission and reception are calculated as follows. Given the following:

$(128 \text{ or in the case of two-byte data } 16384) / (\text{number of parameter steps}) = X \dots Y$

$\text{INT}((Y+1) / 2) = Z$

Reception

If $(\text{MIDI DATA} - Z) < 0$, then $\text{INTERNAL} = 0$

If $((\text{MIDI DATA} - Z) / X) > \text{MAX}$, then $\text{INTERNAL} = \text{MAX}$

Else, $\text{INT}((\text{MIDI DATA} - Z) / X) = \text{INTERNAL}$

Transmission

If $\text{INTERNAL} = 0$, then $\text{MIDI DATA} = 0$

If $\text{INTERNAL} = \text{MAX}$ then $\text{MIDI DATA} = (127 \text{ or in the case of two-byte data } 16384)$

Else, $(X \times \text{INTERNAL}) + \text{INT}(X / 2) + Z = \text{MIDI DATA}$

1.1.3 Program Changes

Transmission/reception of these messages can be turned on/off in the MIDI page.

When a memory recall is executed, the program change message corresponding to that memory number will be transmitted on the specified MIDI channel.

If a program change message is received on the specified MIDI channel or in OMNI, the memory corresponding to that program number will be recalled.

The user is free to create the program change assign table.

1.2 System Exclusive Messages

1.2.1 Bulk Dump/Request

Transmission is always on. Reception can be specified.

Bulk Request messages can be transmitted on the specified MIDI channel by operations in the MIDI page.

Bulk Dumps can be transmitted by operations in the MIDI page, or in response to an incoming Bulk Request that is received on the specified DEVICE channel. The contents of the corresponding memory will be transmitted on the specified DEVICE channel.

When a Bulk Dump is received, the contents of the corresponding memory will be rewritten.

1.2.2 Parameter Change/Request

Transmission / reception can be turned on/off in the MIDI page.

When a parameter of this unit is edited, a parameter change message will be transmitted on the specified DEVICE channel if Parameter Change Transmission is on.

If Parameter Change Reception is on, receiving a Parameter Request on the specified DEVICE channel will cause the content of the corresponding parameter to be transmitted, regardless of whether transmission is on or off.

When Parameter Change Reception is on, and a Parameter Change is received on the specified DEVICE channel, the contents of the corresponding parameter will be modified.

1.2.3 MMC (MIDI Machine Control)

These messages can be transmitted according to the User Define settings.

1.3 System Common Messages

1.3.1 MTC Quarter Frame Messages

Received by Automix for synchronization.

1.3.2 Song Position Pointer

When Automix is set to MIDI Clock Base, these messages are received, and a following Continue command will cause synchronization to begin from the middle of the song.

1.4 System Real Time Messages

1.4.1 Timing Clock

These are received for synchronization when Automix is set to MIDI Clock Base.

1.4.2 Start, Continue, Stop

These are received when Automix is set to MIDI Clock Base, and will start/stop the automix.

These can also be transmitted according to the User Define settings.

1.4.3 Active Sensing

This is transmitted at intervals of less than 300 ms.

If after this message is received, no message is received for an interval longer than 300 ms, Running Status will be cleared.

1.4.4 System Reset

When this is received, Running Status will be cleared.

1.5 MIDI Remote

MIDI Remote settings allow all MIDI commands to be transmitted on the specified channel.

Control Change, Program Change, and Exclusive messages will be received in the format determined for the specified model.

1.6 Echo Back

This setting allows each received command to be re-transmitted.

2. Transmission Condition

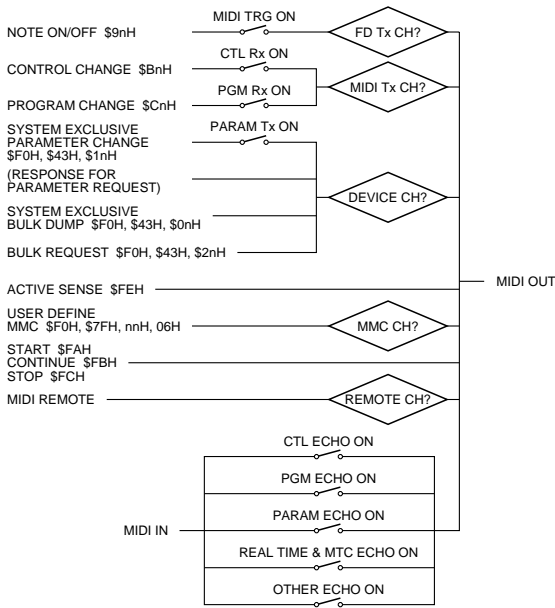

3. Receive Condition

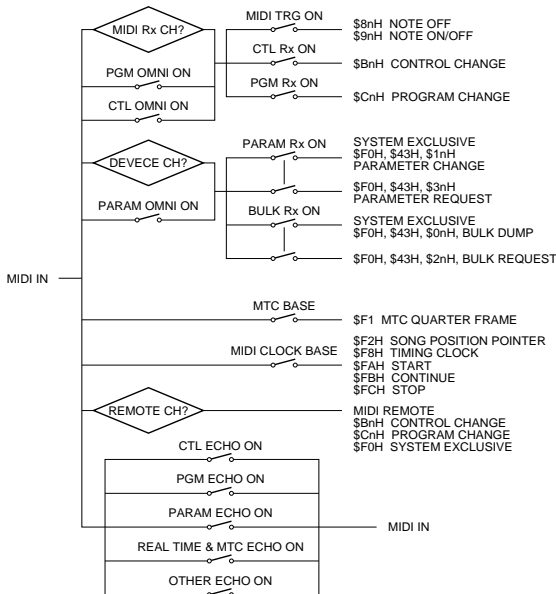

4. Parameter Change & Request Format

Parameter Change & Request (basic format)

STATUS	11110000	F0	System Exclusive Message
ID No.	01000011	43	Manufacturer's ID No. (YAMAHA)
SUB STATUS	0ppppnnn	1n	p=mode 1:parameter change or response for request, 3:parameter request n=0-15 (Device Channel No.1-16)
MODEL ID	00111101	3d	MODEL ID
PARAM TYPE	0ttttttt	tt	(type)
DATA	0ddddd	dd0	data 0
	:	:	:
	0ddddd	ddn	data n (max 33)
EOX	11110111	F7	End Of Exclusive

type:

0x08	edit buffer (byte operation format)
0x09	system memory (byte operation format)
0x0a	function call
0x0b	reserved
0x48	edit buffer (bit operation format)
0x49	system memory (bit operation format)
0x4a	reserved
0x4b	controller (key) (bit operation format)

Parameter Change (byte operation for type 0x08:edit buffer)

continuous address mode

STATUS	11110000	F0	System Exclusive Message
ID No.	01000011	43	Manufacturer's ID No.(YAMAHA)
SUB STATUS	0001nnnn	1n	parameter change or response n=0-15 (Device Channel No.1-16)
MODEL ID	00111101	3d	MODEL ID
PARAM TYPE	00001000	08	byte operation for edit bufer (type)
DATA	00vvaaaa	aa0	bit6:0 continuous address mode v:valid data 0:1st means, 1:0-3bit, 2:4-6bit, 3:2nd means address (H) high 4 bits of 11 bits address address (L) low 7 bits of 11 bits address data
	:	:	: continuous address data
EOX	11110111	F7	End Of Exclusive

individual address mode

STATUS	11110000	F0	System Exclusive Message
ID No.	01000011	43	Manufacturer's ID No. (YAMAHA)
SUB STATUS	0001nnnn	1n	parameter change or response n=0-15 (Device Channel No.1-16)
MODEL ID	00111101	3d	MODEL ID
PARAM TYPE	00001000	08	byte operation for edit buffer (type)
DATA	01vvaaaa	aa0	bit6:1 individual address mode v:valid data 0:ALL, 1:0-3bit, 2:4-6bit, 3:2nd means address (H) high 4 bits of 11 bits address address (L) low 7 bits of 11 bits address data
	0aaaaaaa	aa1	address (H) high 4 bits of 11 bits address
	0ddddd	dd1	address (L) low 7 bits of 11 bits address
	01vvaaaa	aa2	data
	01vvaaaa	aa2	bit6:1 individual address mode v:valid data 0:ALL, 1:0-3bit, 2:4-6bit, 3:2nd means address (H) high 4 bits of 11 bits address address (L) low 7 bits of 11 bits address data
	0aaaaaaa	aa3	address (H) high 4 bits of 11 bits address
	0ddddd	dd2	address (L) low 7 bits of 11 bits address
	:	:	data
EOX	11110111	F7	End Of Exclusive

Parameter Change (bit operation for type 0x48:edit buffer)

```

STATUS      11110000 F0 System Exclusive Message
ID No.      01000011 43 Manufacturer's ID No. (YAMAHA)
SUB STATUS  0001nnnn 1n parameter change n=0-15 (Device Channel No.1-16)

MODEL ID    00111101 3d MODEL ID
PARAM TYPE  01001000 48 bit operation for edit buffer (type)
DATA        0000aaaa aa0 address (H) high 4 bits of 11 bits address
            0aaaaaaa aa1 address (L) low 7 bits of 11 bits address
            0ddddd dd data (bit 0-2:address offset, bit3:0=reset
                    1=set, bit4-6:change bit0-6)
            : :
EOX         11110111 F7 End Of Exclusive

```

Used to change on/off, etc., in bits.

Parameter Change (byte operation for type 0x09:system memory)

```

STATUS      11110000 F0 System Exclusive Message
ID No.      01000011 43 Manufacturer's ID No. (YAMAHA)
SUB STATUS  0001nnnn 1n parameter change or response n=0-15 (Device Channel No.1-16)

MODEL ID    00111101 3d MODEL ID
PARAM TYPE  00001000 09 byte operation for system memory (type)
DATA        0000aaaa aa0 address (H) high 4 bits of 11 bits address
            0aaaaaaa aa1 address (L) low 7 bits of 11 bits address
            0ddddd dd data
            : : : continuous address data
EOX         11110111 F7 End Of Exclusive

```

Parameter Change (bit operation for type 0x49:system memory)

```

STATUS      11110000 F0 System Exclusive Message
ID No.      01000011 43 Manufacturer's ID No. (YAMAHA)
SUB STATUS  0001nnnn 1n parameter change n=0-15 (Device Channel No.1-16)

MODEL ID    00111101 3d MODEL ID
PARAM TYPE  01001000 48 bit operation for system memory (type)
DATA        0000aaaa aa0 address (H) high 4 bits of 11 bits address
            0aaaaaaa aa1 address (L) low 7 bits of 11 bits address
            0ddddd dd data (bit 0-2:address offset, bit3:0=reset
                    1=set, bit4-6:change bit0-6)
            : :
EOX         11110111 F7 End Of Exclusive

```

Used to change the recall safe, etc., in bits.

Parameter Request (type 0x08:edit buffer, 0x09:system memory)

```

STATUS      11110000 F0 System Exclusive Message
ID No.      01000011 43 Manufacturer's ID No. (YAMAHA)
SUB STATUS  0011nnnn 3n parameter request n=0-15 (Device Channel No.1-16)

MODEL ID    00111101 3d MODEL ID
PARAM TYPE  00tttttt tt 08:edit buffer, 09:system memory (type)
DATA        0000aaaa aa0 address (H) high 4 bits of 11 bits address
            0aaaaaaa aa1 address (L) low 7 bits of 11 bits address
            000ddddd dd count (max 0x1f)
EOX         11110111 F7 End Of Exclusive

```

Parameter Change (type 0x0a:function call)**library recall**

```

STATUS      11110000 F0 System Exclusive Message
ID No.      01000011 43 Manufacturer's ID No. (YAMAHA)
SUB STATUS  0001nnnn 1n parameter change n=0-15 (Device Channel No.1-16)

MODEL ID    00111101 3d MODEL ID
PARAM TYPE  00001010 0a function call (type)
DATA        0ddddd dd0 function
            0ddddd dd1 number
            : : channel
EOX         11110111 F7 End Of Exclusive

```

Parameter Request (type 0x0a:function call)

```

STATUS      11110000 F0 System Exclusive Message
ID No.      01000011 43 Manufacturer's ID No. (YAMAHA)
SUB STATUS  0011nnnn 3n parameter request n=0-15 (Device Channel No.1-16)

MODEL ID    00111101 3d MODEL ID
PARAM TYPE  00001010 0a function call (type)
DATA        0ddddd dd0 function
            0ddddd dd1 number
EOX         11110111 F7 End Of Exclusive

```

Parameter Change (type 0x4b:bit operation for controller (key))

```

STATUS      11110000 F0 System Exclusive Message
ID No.      01000011 43 Manufacturer's ID No. (YAMAHA)
SUB STATUS  0001nnnn 1n parameter change n=0-15 (Device Channel No.1-16)

MODEL ID    00111101 3d MODEL ID
PARAM TYPE  01001011 4b controller (type)
DATA        0000ddddd dd0 No. 0-9:key 1-10
            0ddddd dd1 data (bit 0-2:address offset, bit3:0=release
                    1=push, bit4-6:change bit0-7)
            : :
EOX         11110111 F7 End Of Exclusive

```

key number table

	bit0	bit1	bit2	bit3	bit4	bit5	bit6	bit7
key1	ON1	ON2	ON3	ON4	ON5	ON6	ON7	ON8
key2	ON9	ON10	ON11	ON12	ON13	ON14	ON15	ON16
key3	SEL1	SEL2	SEL3	SEL4	SEL5	SEL6	SEL7	SEL8
key4	SEL9	SEL10	SEL11	SEL12	SEL13	SEL14	SEL15	SEL16
key5	STI SEL	RTN SEL	STO SEL	STI ON	RTN ON	STO ON	-----	-----
key6	FADER	EFF1	EFF2	AUX1	AUX2	AUX3	AUX4	LAYER
key7	USER1	USER2	USER3	USER4	-----	SOLO	AUTOMIX	REMOTE
key8	MEM UP	STORE	RECALL	MEM DOWN	UNDO	SCENE	UTIL	MIDI
key9	UP	LEFT	RIGHT	DOWN	ENTER	DIO	GROUP	CUE
key10	EQ L	EQ LM	EQ HM	EQ H	DELAY	DYNA	PAN	VIEW

5. Bulk Dump & Request Format

How to get check sum, adding data from BYTE COUNT (LOW) to just before the CHECK SUM, multiplying -1 (2's complement), resetting MSB (bit7).
check sum =(-sum) & 0x7F

Scene Memory Bulk Dump Format

```

STATUS          11110000 F0 System Exclusive Message
ID No.          01000011 43 Manufacturer's ID No. (YAMAHA)
SUB STATUS      0000nnnn 0n n=0-15 (Device Channel No.1-16)
FORMAT No.     01111110 7E Universal Bulk Dump
BYTE COUNT (HIGH) 00001011 0B 1498 (1488+10)bytes
BYTE COUNT (LOW) 01011010 5A
                01001100 4C 'L'
                01001101 4D 'M'
                00100000 20 ''
                00100000 20 ''
                00111000 38 '8'
                01000010 42 'B'
                00110000 30 '0'
                00110011 33 '3'
DATA NAME      01001101 4D 'M'
                0mmmmmmm mm m=0-50, 127 (Scene Memory No.0-50,
                edit buffer)
                Receive is effective 1-50, 127
DATA          0ddddd ds Scene Memory (1488bytes)
                :
                :
                0ddddd de
CHECK SUM     0eeeeeee ee ee=(-('L'+M'+...+ds+...+de)) AND 7Fh
EOX          11110111 F7 End Of Exclusive

```

Scene Memory Bulk Dump Request Format

```

STATUS          11110000 F0 System Exclusive Message
ID No.          01000011 43 Manufacturer's ID (YAMAHA)
SUB STATUS      0010nnnn 2n n=0-15 (Device Channel No.1-16)
FORMAT No.     01111110 7E Universal Bulk Dump
                01001100 4C 'L'
                01001101 4D 'M'
                00100000 20 ''
                00100000 20 ''
                00111000 38 '8'
                01000010 42 'B'
                00110000 30 '0'
                00110011 33 '3'
DATA NAME      01001101 4D 'M'
                0mmmmmmm mm m=0-50, 127 (Scene Memory No.0-50,
                edit buffer)
EOX          11110111 F7 End Of Exclusive

```

Equalizer Library Bulk Dump Format

```

STATUS          11110000 F0 System Exclusive Message
ID No.          01000011 43 Manufacturer's ID No. (YAMAHA)
SUB STATUS      0000nnnn 0n n=0-15 (Device Channel No.1-16)
FORMAT No.     01111110 7E Universal Bulk Dump
BYTE COUNT (HIGH) 00000000 00 34 (24+10)bytes
BYTE COUNT (LOW) 00100010 22
                01001100 4C 'L'
                01001101 4D 'M'
                00100000 20 ''
                00100000 20 ''
                00111000 38 '8'
                01000010 42 'B'
                00110000 30 '0'
                00110011 33 '3'
DATA NAME      01010001 51 'Q'
                0mmmmmmm mm m=0-79 (Equalizer Library No.1-80)
                Receive is effective 40-79
DATA          0ddddd ds Equalizer Library Memory (24bytes)
                :
                :
                0ddddd de
CHECK SUM     0eeeeeee ee ee=(-('L'+M'+...+ds+...+de)) AND 7Fh
EOX          11110111 F7 End Of Exclusive

```

Equalizer Library Bulk Dump Request Format

```

STATUS          11110000 F0 System Exclusive Message
ID No.          01000011 43 Manufacturer's ID (YAMAHA)
SUB STATUS      0010nnnn 2n n=0-15 (Device Channel No.1-16)
FORMAT No.     01111110 7E Universal Bulk Dump
                01001100 4C 'L'
                01001101 4D 'M'
                00100000 20 ''
                00100000 20 ''
                00111000 38 '8'
                01000010 42 'B'
                00110000 30 '0'
                00110011 33 '3'
DATA NAME      01010001 51 'Q'
                0mmmmmmm mm m=0-79 (Equalizer Library No.1-80)
EOX          11110111 F7 End Of Exclusive

```

Dynamics Library Bulk Dump Format

```

STATUS          11110000 F0 System Exclusive Message
ID No.          01000011 43 Manufacturer's ID No. (YAMAHA)
SUB STATUS      0000nnnn 0n n=0-15 (Device Channel No.1-16)
FORMAT No.     01111110 7E Universal Bulk Dump
BYTE COUNT (HIGH) 00000000 00 30 (20+10)bytes
BYTE COUNT (LOW) 00011110 1e
                01001100 4C 'L'
                01001101 4D 'M'
                00100000 20 ''
                00100000 20 ''
                00111000 38 '8'
                01000010 42 'B'
                00110000 30 '0'
                00110011 33 '3'
DATA NAME      01011001 59 'Y'
                0mmmmmmm mm m=0-79 (Dynamics Library No.1-80)
                Receive is effective 40-79
DATA          0ddddd ds Dynamics Library Memory (20bytes)
                :
                :
                0ddddd de
CHECK SUM     0eeeeeee ee ee=(-('L'+M'+...+ds+...+de)) AND 7Fh
EOX          11110111 F7 End Of Exclusive

```

Dynamics Library Bulk Dump Request Format

```

STATUS          11110000 F0 System Exclusive Message
ID No.          01000011 43 Manufacturer's ID (YAMAHA)
SUB STATUS      0010nnnn 2n n=0-15 (Device Channel No.1-16)
FORMAT No.     01111110 7E Universal Bulk Dump
                01001100 4C 'L'
                01001101 4D 'M'
                00100000 20 ''
                00100000 20 ''
                00111000 38 '8'
                01000010 42 'B'
                00110000 30 '0'
                00110011 33 '3'
DATA NAME      01011001 59 'Y'
                0mmmmmmm mm m=0-79 (Dynamics Library No.1-80)
EOX          11110111 F7 End Of Exclusive

```

Effect Library Bulk Dump Format

```

STATUS          11110000 F0 System Exclusive Message
ID No.          01000011 43 Manufacturer's ID No. (YAMAHA)
SUB STATUS      0000nnnn 0n n=0-15 (Device Channel No.1-16)
FORMAT No.     01111110 7E Universal Bulk Dump
BYTE COUNT (HIGH) 00000000 00 55 (45+10)bytes
BYTE COUNT (LOW) 00110111 37
                01001100 4C 'L'
                01001101 4D 'M'
                00100000 20 ''
                00100000 20 ''
                00111000 38 '8'
                01000010 42 'B'
                00110000 30 '0'
                00110011 33 '3'
DATA NAME      01000101 45 'E'
                0mmmmmmm mm m=0-95 (Effect Library No.1-96)
                Receive is effective 64-95
DATA          0ddddd ds Effect Library Memory (45bytes)
                :
                :
                0ddddd de
CHECK SUM     0eeeeeee ee ee=(-('L'+M'+...+ds+...+de)) AND 7Fh
EOX          11110111 F7 End Of Exclusive

```

Effect Library Bulk Dump Request Format

```

STATUS          11110000 F0 System Exclusive Message
ID No.          01000011 43 Manufacturer's ID (YAMAHA)
SUB STATUS      0010nnnn 2n n=0-15 (Device Channel No.1-16)
FORMAT No.      01111110 7E Universal Bulk Dump
                01001100 4C 'L'
                01001101 4D 'M'
                00100000 20 ''
                00100000 20 ''
                00111000 38 '8'
                01000010 42 'B'
                00110000 30 '0'
                00110011 33 '3'
DATA NAME       01000101 45 'E'
                0mmmmmmmm mm m=0-95 (Effect Library No.1-96)
EOX             11110111 F7 End Of Exclusive

```

CH Library Bulk Dump Format

```

STATUS          11110000 F0 System Exclusive Message
ID No.          01000011 43 Manufacturer's ID No. (YAMAHA)
SUB STATUS      0000nnnn 0n n=0-15 (Device Channel No.1-16)
FORMAT No.      01111110 7E Universal Bulk Dump
BYTE COUNT (HIGH) 00000000 00 80 (70+10)bytes
BYTE COUNT (LOW) 01010000 50
                01001100 4C 'L'
                01001101 4D 'M'
                00100000 20 ''
                00100000 20 ''
                00111000 38 '8'
                01000010 42 'B'
                00110000 30 '0'
                00110011 33 '3'
DATA NAME       01001000 48 'H'
                0mmmmmmmm mm m=0-50 (CH Library No.0-50)
                Receive is effective 2-50
DATA            0dsdsdsds ds CH Library Memory (70 bytes)
                :
                :
CHECK SUM       0eeeeeee ee ee=-( 'L'+ 'M'+...+ds+...+de) AND 7Fh
EOX            11110111 F7 End Of Exclusive

```

CH Library Bulk Dump Request Format

```

STATUS          11110000 F0 System Exclusive Message
ID No.          01000011 43 Manufacturer's ID (YAMAHA)
SUB STATUS      0010nnnn 2n n=0-15 (Device Channel No.1-16)
FORMAT No.      01111110 7E Universal Bulk Dump
                01001100 4C 'L'
                01001101 4D 'M'
                00100000 20 ''
                00100000 20 ''
                00111000 38 '8'
                01000010 42 'B'
                00110000 30 '0'
                00110011 33 '3'
DATA NAME       01001000 48 'H'
                0mmmmmmmm mm m=0-50 (CH Library No.1-50)
EOX            11110111 F7 End Of Exclusive

```

Program Change Assignment Table Bulk Dump Format

```

STATUS          11110000 F0 System Exclusive Message
ID No.          01000011 43 Manufacturer's ID No. (YAMAHA)
SUB STATUS      0000nnnn 0n n=0-15 (Device Channel No.1-16)
FORMAT No.      01111110 7E Universal Bulk Dump
BYTE COUNT (HIGH) 00000001 01 138 (128+10)bytes
BYTE COUNT (LOW) 00001010 0A
                01001100 4C 'L'
                01001101 4D 'M'
                00100000 20 ''
                00100000 20 ''
                00111000 38 '8'
                01000010 42 'B'
                00110000 30 '0'
                00110011 33 '3'
DATA NAME       01010000 50 'P'
                00100000 20 ''
DATA            0dsdsdsds ds Program Change Table (128bytes)
                :
                :
CHECK SUM       0eeeeeee ee ee=-( 'L'+ 'M'+...+ds+...+de) AND 7Fh
EOX            11110111 F7 End Of Exclusive

```

Program Change Assignment Table Bulk Dump Request Format

```

STATUS          11110000 F0 System Exclusive Message
ID No.          01000011 43 Manufacturer's ID (YAMAHA)
SUB STATUS      0010nnnn 2n n=0-15 (Device Channel No.1-16)
FORMAT No.      01111110 7E Universal Bulk Dump
                01001100 4C 'L'
                01001101 4D 'M'
                00100000 20 ''
                00100000 20 ''
                00111000 38 '8'
                01000010 42 'B'
                00110000 30 '0'
                00110011 33 '3'
DATA NAME       01010000 50 'P'
                00100000 20 ''
EOX            11110111 F7 End Of Exclusive

```

Control Change Assignment Table Bulk Dump Format

```

STATUS          11110000 F0 System Exclusive Message
ID No.          01000011 43 Manufacturer's ID No. (YAMAHA)
SUB STATUS      0000nnnn 0n n=0-15 (Device Channel No.1-16)
FORMAT No.      01111110 7E Universal Bulk Dump
BYTE COUNT (HIGH) 00000001 01 238 (228+10)bytes
BYTE COUNT (LOW) 01101110 6e
                01001100 4C 'L'
                01001101 4D 'M'
                00100000 20 ''
                00100000 20 ''
                00111000 38 '8'
                01000010 42 'B'
                00110000 30 '0'
                00110011 33 '3'
DATA NAME       01000011 43 'C'
                00100000 20 ''
DATA            0dsdsdsds ds Control Change Table (114x2bytes)
                :
                :
CHECK SUM       0eeeeeee ee ee=-( 'L'+ 'M'+...+ds+...+de) AND 7Fh
EOX            11110111 F7 End Of Exclusive

```

Control Change Assignment Table Bulk Dump Request Format

```

STATUS          11110000 F0 System Exclusive Message
ID No.          01000011 43 Manufacturer's ID (YAMAHA)
SUB STATUS      0010nnnn 2n n=0-15 (Device Channel No.1-16)
FORMAT No.      01111110 7E Universal Bulk Dump
                01001100 4C 'L'
                01001101 4D 'M'
                00100000 20 ''
                00100000 20 ''
                00111000 38 '8'
                01000010 42 'B'
                00110000 30 '0'
                00110011 33 '3'
DATA NAME       01000011 43 'C'
                00100000 20 ''
EOX            11110111 F7 End Of Exclusive

```

Setup Memory Bulk Dump Format

```

STATUS          11110000 F0 System Exclusive Message
ID No.          01000011 43 Manufacturer's ID No. (YAMAHA)
SUB STATUS      0000nnnn 0n n=0-15 (Device Channel No.1-16)
FORMAT No.     01111110 7E Universal Bulk Dump
BYTE           368
COUNT(HIGH)000000 (358+10)bytes
10 02
BYTE COUNT(LOW) 01110000 70
                01001100 4C 'L'
                01001101 4D 'M'
                00100000 20 ''
                00100000 20 ''
                00111000 38 '8'
                01000010 42 'B'
                00110000 30 '0'
                00110011 33 '3'
DATA NAME       01010011 53 'S'
                00100000 20 ''
DATA            0ddddd ds Setup Memory (358bytes)
                :
                0ddddd de
CHECK SUM       0eeeeeee ee ee=-(('L'+M'+...+ds+...+de)) AND 7Fh
EOX            11110111 F7 End Of Exclusive

```

Setup Memory Bulk Dump Request Format

```

STATUS          11110000 F0 System Exclusive Message
ID No.          01000011 43 Manufacturer's ID (YAMAHA)
SUB STATUS      0010nnnn 2n n=0-15 (Device Channel No.1-16)
FORMAT No.     01111110 7E Universal Bulk Dump
                01001100 4C 'L'
                01001101 4D 'M'
                00100000 20 ''
                00100000 20 ''
                00111000 38 '8'
                01000010 42 'B'
                00110000 30 '0'
                00110011 33 '3'
DATA NAME       01010011 53 'S'
                00100000 20 ''
EOX            11110111 F7 End Of Exclusive

```

Automix Memory Bulk Dump Format

(One bulk out is transmitted by each 1K block)

```

STATUS          11110000 F0 System Exclusive Message
ID No.          01000011 43 Manufacturer's ID No. (YAMAHA)
SUB STATUS      0000nnnn 0n n=0-15 (Device Channel No.1-16)
FORMAT No.     01111110 7E Universal Bulk Dump
BYTE COUNT(HIGH) 00001010 0A 1290 (1280+10)bytes
BYTE COUNT(LOW) 00001010 0A
                01001100 4C 'L'
                01001101 4D 'M'
                00100000 20 ''
                00100000 20 ''
                00111000 38 '8'
                01000010 42 'B'
                00110000 30 '0'
                00110011 33 '3'
DATA NAME       01000001 41 'A'
                0mmmmmm mm m=0-3, 127 (Automix Memory No.1-4,
                current)
DATA            0ddddd ds Automix Memory (1280bytes)
                :
                0ddddd de
CHECK SUM       0eeeeeee ee ee=-(('L'+M'+...+ds+...+de)) AND 7Fh
EOX            11110111 F7 End Of Exclusive

```

Automix Memory Bulk Dump Request Format

```

STATUS          11110000 F0 System Exclusive Message
ID No.          01000011 43 Manufacturer's ID (YAMAHA)
SUB STATUS      0010nnnn 2n n=0-15 (Device Channel No.1-16)
FORMAT No.     01111110 7E Universal Bulk Dump
                01001100 4C 'L'
                01001101 4D 'M'
                00100000 20 ''
                00100000 20 ''
                00111000 38 '8'
                01000010 42 'B'
                00110000 30 '0'
                00110011 33 '3'
DATA NAME       01000001 41 'A'
                0mmmmmm mm m=0-3, 127 (Automix Memory No.1-4,
                current)
EOX            11110111 F7 End Of Exclusive

```

MIDI Remote Bulk Dump Format

```

STATUS          11110000 F0 System Exclusive Message
ID No.          01000011 43 Manufacturer's ID No. (YAMAHA)
SUB STATUS      0000nnnn 0n n=0-15 (Device Channel No.1-16)
FORMAT No.     01111110 7E Universal Bulk Dump
BYTE COUNT(HIGH) 00001010 0A 1320 (1310+10)bytes
BYTE COUNT(LOW) 00101000 28
                01001100 4C 'L'
                01001101 4D 'M'
                00100000 20 ''
                00100000 20 ''
                00111000 38 '8'
                01000010 42 'B'
                00110000 30 '0'
                00110011 33 '3'
DATA NAME       01010010 52 'R'
                0mmmmmm mm m=0-3 (MIDI Remote No.1-4)
DATA            0ddddd ds MIDI Remote (1310bytes)
                :
                0ddddd de
CHECK SUM       0eeeeeee ee ee=-(('L'+M'+...+ds+...+de)) AND 7Fh
EOX            11110111 F7 End Of Exclusive

```

MIDI Remote Bulk Dump Request Format

```

STATUS          11110000 F0 System Exclusive Message
ID No.          01000011 43 Manufacturer's ID (YAMAHA)
SUB STATUS      0010nnnn 2n n=0-15 (Device Channel No.1-16)
FORMAT No.     01111110 7E Universal Bulk Dump
                01001100 4C 'L'
                01001101 4D 'M'
                00100000 20 ''
                00100000 20 ''
                00111000 38 '8'
                01000010 42 'B'
                00110000 30 '0'
                00110011 33 '3'
DATA NAME       01010010 52 'R'
                0mmmmmm mm m=0-3 (MIDI Remote No.1-4)
EOX            11110111 F7 End Of Exclusive

```

6. Parameter List For Control Change Assign

FADER

CHANNEL	CH1-24, ST IN, RETURN1, RETURN2, MAS AUX1-4, MAS BUS1-4, MAS ST
EFF1 SEND	CH1-24, ST IN
EFF2 SEND	CH1-24, ST IN
AUX1 SEND	CH1-24, ST IN, RETURN1, RETURN2
AUX2 SEND	CH1-24, ST IN, RETURN1, RETURN2
AUX3 SEND	CH1-24, ST IN, RETURN1, RETURN2
AUX4 SEND	CH1-24, ST IN, RETURN1, RETURN2
BUS TO ST	1-4

ON

CHANNEL	CH1-24, ST IN, RETURN1, RETURN2, MAS AUX1-4, MAS BUS1-4, MAS ST
BUS TO ST	1-4

PAN

CHANNEL	CH1-24, ST IN L,R, RETURN1 L,R, RETURN2 L,R
AUX1, 2	CH1-24, ST IN L,R, RETURN1 L,R, RETURN2 L,R
AUX3,4	CH1-24, ST IN L,R, RETURN1 L,R, RETURN2 L,R
BUS TO ST	1-4

BALANCE

ST IN, RETURN1, RETURN2, MAS ST

SURROUND

LR (LEFT,RIGHT)	CH1-24, ST IN L,R, RETURN1 L,R, RETURN2 L,R
FR (FRONT,REAR)	CH1-24, ST IN L,R, RETURN1 L,R, RETURN2 L,R

PHASE

CH1-24, ST IN L,R

PRE/POST

EFF1 SEND	CH1-24, ST IN
EFF2 SEND	CH1-24, ST IN
AUX1 SEND	CH1-24, ST IN, RETURN1, RETURN2
AUX2 SEND	CH1-24, ST IN, RETURN1, RETURN2
AUX3 SEND	CH1-24, ST IN, RETURN1, RETURN2
AUX4 SEND	CH1-24, ST IN, RETURN1, RETURN2
BUS TO ST	1-4

ROUTING

BUS1	CH1-24, ST IN, RETURN1, RETURN2
BUS2	CH1-24, ST IN, RETURN1, RETURN2
BUS3	CH1-24, ST IN, RETURN1, RETURN2
BUS4	CH1-24, ST IN, RETURN1, RETURN2
MAS ST	CH1-24, ST IN, RETURN1, RETURN2
YGDAL	1-8

DELAY

ON	CH1-24, ST IN, MAS BUS1-4, MAS ST L,R
TYPE	CH1-24, ST IN
TIME HIGH	CH1-24, ST IN, MAS BUS1-4, MAS ST L,R
TIME LOW	CH1-24, ST IN, MAS BUS1-4, MAS ST L,R
MIX HIGH	CH1-24, ST IN
MIX LOW	CH1-24, ST IN
FB GAIN H	CH1-24, ST IN
FB GAIN L	CH1-24, ST IN

EQ

ON	CH1-24, ST IN, RETURN1, RETURN2, MAS AUX1-4, MAS BUS1-4, MAS ST
F LOW	CH1-24, ST IN, RETURN1, RETURN2, MAS AUX1-4, MAS BUS1-4, MAS ST
G LOW	CH1-24, ST IN, RETURN1, RETURN2, MAS AUX1-4, MAS BUS1-4, MAS ST
Q LOW	CH1-24, ST IN, RETURN1, RETURN2, MAS AUX1-4, MAS BUS1-4, MAS ST
F L-MID	CH1-24, ST IN, RETURN1, RETURN2, MAS AUX1-4, MAS BUS1-4, MAS ST
G L-MID	CH1-24, ST IN, RETURN1, RETURN2, MAS AUX1-4, MAS BUS1-4, MAS ST
Q L-MID	CH1-24, ST IN, RETURN1, RETURN2, MAS AUX1-4, MAS BUS1-4, MAS ST
F H-MID	CH1-24, ST IN, RETURN1, RETURN2, MAS AUX1-4, MAS BUS1-4, MAS ST
G H-MID	CH1-24, ST IN, RETURN1, RETURN2, MAS AUX1-4, MAS BUS1-4, MAS ST
Q H-MID	CH1-24, ST IN, RETURN1, RETURN2, MAS AUX1-4, MAS BUS1-4, MAS ST
F HIGH	CH1-24, ST IN, RETURN1, RETURN2, MAS AUX1-4, MAS BUS1-4, MAS ST
G HIGH	CH1-24, ST IN, RETURN1, RETURN2, MAS AUX1-4, MAS BUS1-4, MAS ST
Q HIGH	CH1-24, ST IN, RETURN1, RETURN2, MAS AUX1-4, MAS BUS1-4, MAS ST
ATT	CH1-24, ST IN

DYNAMICS

ON	CH1-24, ST IN, RETURN1, RETURN2, MAS AUX1-4, MAS BUS1-4, MAS ST
KEYIN	CH1-24, ST IN, RETURN1, RETURN2, MAS AUX1-4, MAS BUS1-4, MAS ST
RATIO/H_H(HOLD HIGH)	CH1-24, ST IN, RETURN1, RETURN2, MAS AUX1-4, MAS BUS1-4, MAS ST
KNE/H_L/W(KNEE/HOLD LOW/WIDTH)	CH1-24, ST IN, RETURN1, RETURN2, MAS AUX1-4, MAS BUS1-4, MAS ST
THRESHOLD	CH1-24, ST IN, RETURN1, RETURN2, MAS AUX1-4, MAS BUS1-4, MAS ST
ATTACK	CH1-24, ST IN, RETURN1, RETURN2, MAS AUX1-4, MAS BUS1-4, MAS ST
G/RANGE(GAIN/RANGE)	CH1-24, ST IN, RETURN1, RETURN2, MAS AUX1-4, MAS BUS1-4, MAS ST
REL/DCY H(RELEASE/DECAY HIGH)	CH1-24, ST IN, RETURN1, RETURN2, MAS AUX1-4, MAS BUS1-4, MAS ST
REL/DCY L(RELEASE/DECAY LOW)	CH1-24, ST IN, RETURN1, RETURN2, MAS AUX1-4, MAS BUS1-4, MAS ST

EFFECT

1 PARAM H	1-16
1 PARAM L	1-16
2 PARAM H	1-16
2 PARAM L	1-16

NO ASSIGN

MIDI Implementation Chart

Function...		Transmitted	Recognized	Remarks
Basic Channel	Default Changed	1-16 1-16	1-16 1-16	Memorized
Mode	Default Messages Altered	X X *****	OMNI off/OMNI on X X	Memorized
Note Number	True Voice	37-44 *****	36-96 X	
Velocity	Note On Note Off	x9nH, v=127 x9nH, v=0	X X	
After Touch	Keys Ch's	X X	X X	
Pitch bend		X	X	
Control Change	0-95, 102-119	0	0	Assignable
Prog Change	:True#	0-127 *****	0-127 0-50	Assignable
System Exclusive		0	0	*1
System Common	:Song Pos :Song Sel :Tune	X X X	0 X X	
System Real Time	:Clock :Commands	X 0	0 0	
Aux Messages	:Local ON/OFF :All Notes OFF :Active Sense :Reset	X X 0 X	X X X X	
Notes	MTC quarter frame message is recognized *1: Bulk Dump/Request, Parameter Change/Request, and MMC. For MIDI Remote, ALL messages can be transmitted.			

Appendix D: Resources

Books

- *Introducing Digital Audio*, Ian R Sinclair, second edition, PC Publishing, 1992. A good all-round introduction to digital audio. Second edition explains oversampling and bitstream techniques.
- *Principles of Digital Audio*, Ken C. Pohlmann, Howard W.Sams & Co, 1989. Covering all aspects of digital audio, this book is ideal for the newcomer who wants to know the basics—plus a bit more.
- *The Art of digital Audio*, John Watkinson, Focal Press (Butterworth Group), 1990. An essential read for digital audio professionals—but only for the serious!
- *The MIDI Ins, Outs & Thrus*, Jeff Rona, Hal Leonard Publishing, 1992. An excellent introduction to MIDI with many illustrations for easy understanding.
- *MIDI Systems & Control*, Francis Rumsey, second edition, Focal Press, 1994. Covers all MIDI topics in detail and looks at how MIDI can be used to control systems (i.e., digital mixers, synths).
- *THE MIDI BOOK*, Steve DeFuria with Joe Scacciaferro, Hal Leonard Books. A good introduction for anyone new to MIDI.
- *THE MIDI RESOURCE BOOK*, Steve DeFuria with Joe Scacciaferro, Hal Leonard Books, 1988. Following on from THE MIDI BOOK, this one looks at the real nuts and bolts of MIDI including the MIDI specification and how to read MIDI Implementation Charts.
- *Yamaha Sound Reinforcement Handbook*, Gary Davis and Ralph Jones, second edition, Hal Leonard Publishing Corporation, 1990. Although primarily concerned with sound reinforcement, many of the subjects covered also apply to studio audio applications. The second edition also includes a comprehensive section on MIDI.

Yamaha Web Site

<http://www.yamaha.co.jp/product/proaudio/homeenglish/index.html>

Glossary

A/D converter—An electronic device that converts analog signals into digital signals.

AES/EBU format—The digital audio format established by the AES (Audio Engineering Society) and EBU (European Broadcasting Union) that is used to transfer digital audio data between professional equipment. Two channels of digital audio (left/odd and right/even) are carried in one connection, usually an XLR-type connection.

AFL (After Fader Listen)—A mixer function that allows monitoring of a signal after the channel fader. *Contrast with PFL.*

Aliasing—A type of signal distortion that occurs during A/D conversion if the sampling rate is less than twice that of the highest audio frequency. A/D converters employ aliasing filters to remove audio frequencies higher than half the sampling rate. *See also Nyquist Sampling Theorem.*

Anti-aliasing—In digital audio, a technique used to prevent aliasing in the form of an anti-aliasing filter before A/D conversion. This filter removes audio frequencies that are higher than half the sampling frequency (e.g., for a 32 kHz sampling rate, audio frequencies above 16 kHz are filtered).

Bulk Dump—A MIDI function that allows data transfer between MIDI devices. Data is transmitted as MIDI System Exclusive.

Bus—A common conductor used to collect and distribute audio signals.

CH—Abbreviation for channel.

Clipping—The unwanted distortion effect of overloading an audio circuit with a signal that is too large.

Coaxial format—The consumer digital audio format developed by Sony and Philips that is used to transfer digital audio data between consumer-type digital audio equipment, such as CD players, consumer DAT decks, DCC, and MiniDisc decks. Two channels of digital audio (left & right) are carried in one connection, usually a phono connection. This format is also referred to as IEC958 and S/PDIF.

Control Change—A type of MIDI message that offers real-time control. Typical Control Changes include Modulation, Volume, Pan, and Portamento.

D/A converter—An electronic device that converts digital signals into analog signals.

De-emphasis—*See Emphasis.*

DIO—Abbreviation of digital input and output.

Dither—The process of adding low-level random noise to audio signals in order to reduce quantization noise in A/D converters. Dither is also applied during digital audio wordlength reduction (e.g., 20 to 16 bit conversion).

DSP (Digital Signal Processor)—A chip designed specifically for processing large amounts of data at high speed and in real time. This type of processor is ideal for handling digital audio data.

Dynamic mix automation—Mixdown automation where mix settings are adjusted in real time.

Dynamic range—The difference between the loudest and quietest signal levels in a system. In an audio device, usually the difference between the maximum output level and the residual noise floor. In a digital system, the available dynamic range is determined by the data resolution, about 6 dB per digital bit. Hence, a 16-bit system theoretically provides a 96 dB dynamic range.

Edit buffer—The internal RAM area that stores the current mix settings (i.e. the current mix scene). When a mix scene is stored, the Edit Buffer data is copied to the selected scene memory. When a mix scene is recalled, the data of the selected scene memory is copied back to the Edit Buffer.

EFF—Abbreviation for effect.

Emphasis—A technique that was used to improve the noise performance of the first generation of AD/DA converters. Although not used today, it is often provided for compatibility with older recordings. The emphasis technique consisted of boosting signals above 3.5 kHz by 6 dB/octave before A/D conversion. The playback device sensed the Emphasis flag in the digital audio signal and de-emphasised the signal after D/A conversion.

EQ snapshot—A set of EQ settings.

Fade time—The time it takes a fader to move to its new position when a mix scene is recalled. Used for cross fade.

General MIDI—An extension to the MIDI Standard that, among other things, states that a GM compatible tone generator must be at least 24-note polyphonic, have 16 parts, and 128 specific preset voices.

GR—Abbreviation for gain reduction.

Initial settings—The settings used when a device is first turned on after leaving the factory. Also referred to as the default or factory settings.

LCD (Liquid Crystal Display)—A type of display device that uses liquid crystal to generate characters and graphics.

LED (Light Emitting Diode)—A type of diode that lights up when an electric current is applied.

Line-Level Signal—A signal in the range from -20 dB to $+20$ dB. These are essentially high-level signals. Most audio equipment outputs signals at line level. *Contrast with* Low-Level Signal.

Low-Level Signal—A signal in the range from -100 dB to -20 dB. Microphone and electric guitar signals are in this range. *Contrast with* Line-Level Signal.

LSB (Least Significant Byte)—The byte of a digital word that represents the lowest value. *Contrast with* MSB.

MIDI (Musical Instrument Digital Interface)—An internationally agreed protocol that allows electronic musical instruments and audio equipment to communicate.

MIDI Clock—A clock signal transmitted as MIDI data. MIDI Clock refers to a timing signal and Start, Continue, and Stop commands.

MIDI Device Numbers—Identity numbers assigned to MIDI devices for transmitting System Exclusive data.

MIDI Song Position Pointer—A type of MIDI message that is used to derive position information from a MIDI Clock signal. So no matter where you start playback in a song, your MIDI sequencer will locate to that point and then play along in synchronization.

MIDI timecode—*See* MTC.

Mix scene—A set of mixer settings at a particular point in a song. Just like a play, a piece of music consists of various scenes, each requiring different mixer settings. Mix scenes are stored in scene memories, and can be recalled using front panel buttons or MIDI Program Change messages. These messages can be sent from a computer, MIDI footswitch, keyboard, or sequencer. *See also* Scene memories.

MMC (MIDI Machine Control)—A set of MIDI messages that can be used to control audio and video tape machines, disk recorders, and other studio equipment. Typical MMC commands include Stop, Play, Rewind, and Pause.

Modulation—In general audio, using an LFO (low frequency oscillator) to control a signal's frequency (pitch) or amplitude (level). The LFO frequency is set using modulation frequency parameters and the amount of LFO control is set using modulation depth parameters. Delay time and auto-pan speed parameters are also modulated.

MSB (Most Significant Byte)—The byte of a digital word that represents the highest value. *Contrast with* LSB

MTC (MIDI Timecode)—An addition to the MIDI Standard that allows audio equipment to be synchronized. MIDI Timecode contains clock and position information.

Noise gate—An electronic switch that opens when a trigger signal falls below a set threshold point and closes when the trigger signal exceeds that same threshold point. Used to shut off unwanted hiss and noise.

Nominal level—*See* Operating Level.

Nyquist theorem—The Nyquist theorem states that the sampling rate of a digital audio system must be at least twice that of the highest audio frequency, otherwise waveform distortion called aliasing will occur. *See also* Aliasing.

OMNI—The MIDI mode in which a device responds to MIDI data on all 16 channels.

Operating level—This is the signal level at which a piece of audio equipment is designed to operate. The two most common operating levels are -10 dBV (316 mV), which is used by semiprofessional equipment, and $+4$ dBu (1.23 V), which is used by professional equipment.

Oversampling—Sampling an audio signal at a rate higher than the normal sampling rate. The net effect is that noise caused by quantization errors is reduced.

PAM (Pulse Amplitude Modulation)—In the first part of the A/D conversion, pulses occurring at the sampling rate are modulated by an analog audio signal. *See also* PCM.

PC—Originally, the abbreviation for personal computer. Although today it's used as the generic name for an IBM compatible personal computer, usually running a version of the Microsoft Windows operating system.

PCM (Pulse Code Modulation)—In the second part of the A/D conversion, the pulses derived using PAM are converted into binary data words using PCM. *See also* PAM.

Peaking—A type of EQ circuit used to cut and boost a band of frequencies. It produces a mountain-peak type curve. The width of the frequency band is controlled by the Q parameter. Midband EQ is usually of the peaking type. *Compare with* Shelving.

PFL (Pre Fader Listen)—A mixer function that allows monitoring of a signal before it's fed to the channel fader. *Contrast with* AFL.

Pink noise—A type of random noise that contains an equal amount of energy per octave. The bands 100–200, 800–1600, and 3000–6000 all contain the same amount of energy. White noise, on the other hand, has an equal amount of energy per frequency band. That is, 100–200, 800–900, and 3000–3100.

Post fader—A point in the signal path after a fader. Aux send controls are often configured as post-fader sends, which means the signal for the aux send is sourced after the channel fader. The advantage of this is that the aux send signal can be controlled at the same time as the main channel signal using the channel fader. Post-fader aux sends are often used to feed effects processors. *See also* AFL.

Pre fader—A point in the signal path before a fader. Aux send controls are often configured as pre-fader sends, which means the signal for the aux send is sourced before the channel fader. The advantage of this is that the aux send signal can be controlled independently of the main channel signal. Pre-fader aux sends are often used for fold-back mixes. *See also* PFL.

Program Change—A type of MIDI message that is used to recall programs or patches.

Q—The unit used to measure an EQ circuit's selectivity. For high values the frequency band is narrow. For low values, it is wide.

Quantization—The PCM process where PAM pulses are approximated to the nearest binary value available.

S/PDIF format—*See* Coaxial format.

Sampling rate — The number of times per second that an analog audio signal is sampled (measured) during A/D conversion. The value of each sample is stored as a data word. Standard sampling rates are 32 kHz, 44.1 kHz, and 48 kHz.

Scene memories—Memory locations used to store mix scenes. *See also* Mix scene.

Serial mouse—A type of computer mouse that connects to a computer's serial port.

Shelving—A type of EQ circuit used to cut and boost frequencies above or below a set frequency. It produces a shelf-looking response curve. High and low EQs are usually of the shelving type. *Contrast with* Peaking.

Signal to Noise Ratio (S/N)—In an audio system, the difference between the operating signal level and the residual noise floor, usually expressed as a ratio in decibels. It's used as a measure of an audio system's noise performance.

SMPTE timecode—Pronounced "simply", SMPTE timecode is the timecode format used for television recorders by the SMPTE (Society of Motion Pictures and Television Engineers) in the United States and the EBU (European Broadcast Union) in Europe.

Snapshot—*See* Mix scene.

ST IN—03D stereo input channel.

ST OUT—03D stereo output.

System Exclusive—A type of MIDI message that is used to transmit data between MIDI devices exclusively. *See also* Bulk Dump.

THD (Total Harmonic Distortion)—The amount of distortion introduced by an audio system, usually expressed as a percentage of the actual signal. Compared to third-harmonic distortion, which is the measure of a single harmonic, total harmonic distortion is the sum of the distortions produced at all harmonics.

Unity gain—A gain of one.

Wordclock—A clock signal used to synchronize the data processing circuits of all devices connected in a digital audio system. The wordclock frequency is the same as the sampling rate. *See also* Bit clock.

YGDAI (Yamaha General Digital Audio Interface)—The YGDAI interface system allows Yamaha digital audio equipment to be connected directly to modular digital multitrack recorders, digital workstations, and other digital equipment, using a variety of industry standard digital audio formats and protocols.

Index

Symbols

+48 V phantom 37

Numerics

02R

cascade with 03D 227
MIDI Remote 245

03D

benefits 4
block diagram 21
configuration 4
dimensions 266
features 3
initializing 214
level diagram 253
MIDI 232
MIDI Remote 245
preferences 213
rear panel 16
sonic performance 4
top panel 10

2+2 surround pan 63

2TR IN

connector 16
using 77

3+1 surround pan 63

3+2+1 surround pan 64

44.1 kHz 216

48 kHz 216

A

A/D converter, definition 281

Aborting an automix 178

Active sensing filter 238

ADAT YGDAI card 223

AES/EBU

definition 281
dither 220
emphasis 221
input select 221
input status 222
output 219
wordclock source 216
YGDAI card 223

AFL, definition 281

Aliasing, definition 281

Amp simulator 139

Analog controls 11

Analog inputs specs 263

Analog outputs specs 264

Anti-aliasing, definition 281

Assign. *See* Routing

Attenuator 38

Audio books 279

Auto navigate, wordclock 217

Automix

ABORT 178
about 176
AUTO REC 178
Bulk Dump 242
clearing memories 206
controls 178
creating new 180
current automix 177
deleting 206
editing fader moves 190
enabling 180
extracting events 198
fader return 190
fader trim 190
first mix scene 179
memory 177
midnight phenomenon 179
off-line editing 193
offset 182
overwrite 184
PLAY 178
playing 187
punch-in/out 189
REC 178
recalling 203
recording 185
rerecording 188
safe channels 183
selecting parameters 184
STOP 178
storing 202
summary 7
swapping the current 204
time base setting 181
time counter 178
titling 205
undo 200
undo buffer 201
user define buttons 210
what's recorded 176

Autopan 132

AUX OUT connector 18

Aux Pan page 94

Aux sends

analog outputs 90
block diagram 95
channel view 110
dynamics processors 93
EQ 93
input channels 43
level setting 93
metering 90
monitoring 90

muting 93

pre/post 92

stereo pairs 94

using 91

YGDAI outputs 90

B

Backup battery 214

Balance 59

effects returns 59

stereo input channel 59

stereo output 85

Battery check 214

Baud rate, TO HOST 234

Benefits of a digital mixer 4

Block diagram

aux sends 95
bus outs 102
cascade 229
effects 142
input channels 44
main 21
monitor 82
stereo output 87
YGDAI 225

BNC, wordclock 218

Books 279

Bulk Dump

definition 281
using 242

Bulk page 242

Burst noise 212

BUS OUT connector 17

Bus outs

analog outputs 98
block diagram 102
channel view 110
delay 100
dynamics processors 99
EQ 99
fader setting 99
metering 98
monitoring 98
muting 99
rec out 98
routing 98
routing to stereo 101
stereo pairs 101
YGDAI outputs 98
Bus to ST page 101
Bus, definition 281
Bypassing the EQ 47

C

Calibrating the faders 214

Cans 73

- Cascade
 - block diagram 229
 - configuring 227
 - delay compensation 228
 - digital stereo input 221
 - Cascade page 227
 - Cascade YGDAI card 223
 - CH 1-16 page, meters 79
 - CH 17-24 page, meters 80
 - CH Delay page 40, 86, 100
 - CH View page 108
 - CH, definition 281
 - Channel control buttons 13
 - Channel delay
 - using 40
 - viewing settings 41
 - Channel library
 - about 104
 - Bulk Dump 242
 - recalling programs 106
 - storing programs 105
 - titling programs 107
 - Channel specs 259
 - Channel status, digital inputs 222
 - Channel view 108
 - Checking levels 79
 - Chorus 130
 - Clipping, definition 281
 - Coaxial
 - definition 281
 - dither 220
 - emphasis 221
 - input select 221
 - input status 222
 - output 219
 - wordclock source 216
 - Compander 155
 - Compressor 151
 - Configuration, summary 4
 - Conflict, channel programs 106
 - Connectors
 - 2TR IN 16
 - AUX OUT 18
 - BUS OUT 17
 - DIGITAL STEREO IN 19
 - input channel overview 36
 - inputs 1-8 16
 - inputs 9-16 17
 - inserts 17
 - MIDI 20
 - MONITOR OUT 17
 - MOUSE 19
 - PHONES 16
 - REC OUT 18
 - ST IN 17
 - ST OUT 18
 - TO EDITOR 19
 - TO HOST 19
 - WORDCLOCK 19
 - Contrast control 12
 - Control Change
 - definition 281
 - echo 235
 - omni 235
 - receive 235
 - scene memory assign 240
 - table dump 242
 - transmit 235
 - Control I/O specs 265
 - Creating a new automix 180
 - Crossfade 173
 - CSR, surround pan 69
 - CTL Asgn. page 240
 - Current automix 177
 - Cursor buttons 29
- D**
- D.in Setup page 216, 221
 - D.out Setup page 219, 224
 - D/A converter, definition 281
 - De-emphasis 221
 - Delay
 - bus outs 100
 - cascade compensation 228
 - input channels 40
 - stereo output 86
 - Delay LCR 130
 - Delay+ER 137
 - Delay+rev 138
 - Delay->ER 137
 - Delay->rev 138
 - Deleting automixes 206
 - Device number
 - Bulk Dump 237
 - MMC 234
 - Dial 29
 - Digital I/O, summary 6
 - Digital inputs specs 265
 - Digital mixer benefits 4
 - Digital outputs specs 265
 - DIGITAL STEREO IN connector 19
 - Digital stereo input
 - channel status 222
 - emphasis 221
 - sync caution message 213
 - using 221
 - Digital stereo output
 - dither 220
 - using 219
 - Dimensions 266
 - DIO, definition 281
 - Direct outputs
 - routing channels 43
 - Disabling automix 180
 - Display
 - about 12
 - channel control pages 13
 - contrast 12
 - elements 28
 - explained 24
 - fader mode pages 13
 - fader status indicators 26
 - faders 28
 - parameter boxes 29
 - peak indicators 25
 - rotary controls 28
 - scene memory area 165
 - setup pages 12
 - signal indicators 25
 - switches 28
 - Display messages 254
 - Dither 220
 - Dither page 220
 - Dly 1-16 page 41
 - Dly 17-24 page 41
 - Dolby AC-3 surround 64
 - Dolby surround 63
 - Drop frame 181
 - DSP, definition 281
 - Dual pitch 133
 - Ducking 153
 - Dump, MIDI 242
 - Dyn. Edit page 145, 146
 - Dyna.filter 140
 - Dyna.flange 140
 - Dyna.phase 141
 - Dynamic automation, definition 281
 - Dynamic range, definition 281
 - Dynamics library
 - about 147
 - Bulk Dump 242
 - preset programs 144
 - recalling programs 149
 - storing programs 148
 - titling 150
 - Dynamics Library page 147, 148, 149, 150
 - Dynamics processors
 - about 144
 - key in 145
 - parameters 157
 - summary 6
 - types 151
 - using 146
- E**
- Early ref. 129
 - Echo
 - channel effect 40
 - effects 130

- MIDI 235
 - Edit buffer
 - about 164
 - definition 282
 - Editing
 - extracting events 198
 - off-line 193
 - EFF, definition 282
 - Eff. Edit page 118, 122, 123
 - Effects
 - about 118
 - block diagram 142
 - parameters 129
 - pre/post fader sends 123
 - summary 5
 - using 122
 - Effects library
 - about 125
 - Bulk Dump 242
 - preset programs 118
 - recalling programs 127
 - storing programs 126
 - titling 128
 - Effects Library page 125, 126, 127, 128
 - Effects returns
 - balance 59, 124
 - channel view 109
 - dynamics processors 124
 - EQ 123
 - level setting 124
 - metering 79
 - muting 124
 - pan 124
 - routing 59, 124
 - using 123
 - Emphasis
 - definition 282
 - digital stereo input 221
 - YGDAI 223
 - Enabling automix 180
 - Encoder 29
 - ENTER button 29
 - EQ
 - about 46
 - bypassing 47
 - library 48
 - Q 47
 - resetting 47
 - specs 262
 - summary 5
 - using 47
 - EQ library
 - Bulk Dump 242
 - preset programs 52
 - recalling programs 50
 - storing programs 49
 - titling programs 51
 - EQ library page 48, 49, 50, 51
 - EQ page 38, 47
 - Error messages 254
 - Event Edit page 193
 - Events
 - extracting 198
 - off-line editing 193
 - rerecording 188
 - Expander 154
 - Extract page 198
 - Extracting events 198
- F**
- Fade time
 - definition 282
 - mix scenes 173
 - Fade Time page 173
 - Fader Edit page 183, 191
 - Fader groups
 - disabling 112
 - making 112
 - Fader mode buttons 13
 - Fader start
 - operation 236
 - transmit 234
 - Faders
 - about 15
 - automix editing 190
 - aux sends 93
 - bus outs 99
 - calibrating 214
 - effects returns 124
 - grouping 112
 - input channels 42
 - mixing layer 32
 - mode indicators 26
 - stereo output 85
 - summary 5
 - trim and return modes 192
 - using display faders 28
 - Falling speed, meters 213
 - Features 3
 - Fitting YGDAI cards 226
 - Flange 131
 - Freeze 141
 - Function display 25
 - Function menu 30
 - Further reading 279
- G**
- GAIN control
 - about 11
 - using 37
 - Gain reduction, meters 79
 - Gang mode, pan 59
 - Gate 152
 - Gate reverb 129
 - General MIDI
 - definition 282
 - MIDI Remote 247
 - General specs 257
 - GR, definition 282
 - Group page 112, 113
 - Grouping
 - faders 112
 - mutes 113
 - GUI interface, summary 6
- H**
- Headphones 73
 - High EQ 47
 - High pass filter (EQ) 47
 - Hi-mid EQ 47
 - Home page 279
 - Host indicator 24
 - HPF 47
 - HQ.Pitch 132
- I**
- IFU4 Interface Unit 218
 - Implementation chart, MIDI 278
 - Initial settings, definition 282
 - Initializing the 03D 214
 - Input attenuator 38
 - Input channels
 - 1 & 2 36
 - 17 to 24 36
 - 3 to 8 36
 - 9 to 16 36
 - channel view 108
 - dynamics processors 42
 - EQ 42
 - fader setting 42
 - metering 79
 - overview 36
 - pan 59
 - routing 59
 - stereo input channel 36
 - user define buttons 210
 - Input connectors 1-8 16
 - Input connectors 9-16 17
 - Input delay 40
 - Inserts 17
 - Installing YGDAI cards 226
 - Interface, summary 6
 - Internal dynamics. *See* dynamics processors
 - Internal effects. *See* Effects
 - Internal wordclock 216
 - Inverted gang mode, pan 59

K

Key in, dynamics 145

L

LCD

- about 12
- definition 282

LED, definition 282

Level diagram 253

Library

- channel 104
- dynamics processors 147
- effects 125
- EQ 48
- user define buttons 209

Library page, channels 104, 105, 106, 107

Library specs 262

Line-level signal, definition 282

Lo-mid EQ 47

Low EQ 47

Low pass filter (EQ) 47

Low-level signal, definition 282

LPF 47

LSB, definition 282

M

M button 30

Macintosh, TO HOST 235

Main page 176, 181, 182, 184, 185, 188, 189, 190, 200, 201

Memory page 180, 185, 202, 203, 204, 205, 206

Memory specs 262

Memory, automix 177

Metering 79

- aux sends 90
- bus outs 98
- falling speed 213
- gain reduction 79
- peak hold 79
- pre/post 79
- stereo output 84

MIDI

- about 232
- Bulk Dump 242
- connectors 20, 232
- data format 271
- definition 282
- display indicator 24
- implementation chart 278
- input monitor 238
- multiport 234
- port setup 233
- receive channel 235

scene memory to Program

Change table 267

setup 235

Song Position Pointers 181

standard I/F 233

summary 7

transmit channel 235

MIDI Clock

counter 178

definition 282

echo setting 236

input monitor 238

receive port/channel 234

setting 181

user define buttons 209

MIDI Moni. page 238

MIDI Remote

about 243

Bulk Dump 242

button 14

channels/ports 234

connection 243

GM tone generator 247

Pro Tools 249

Programmable Mixer 01 245

ProR3 246

REV500 246

setup 244

user define page 250

XG tone generator 248

MIDI Setup page 235

MIDI/HOST page 233

Midnight phenomenon 179

Mix scenes

- Bulk Dump 242
- Control Change assign 240
- definition 282
- fade time 173
- first in automix 179
- Program Change assign 239
- protecting 170
- recall undo 169
- recalling 168
- safe channels 174
- sorting 172
- storing 166
- titling 171
- user define buttons 209

Mixdown solo mode 75

Mixing layer

- about 15
- fader mode indicators 26
- faders 32
- ON buttons 31
- SEL buttons 31
- using 31

MMC

definition 283

device number 234

user define buttons 209

Modular multitrack recorders 224

Modulation, definition 283

Moni. Setup page 72, 74

MONITOR OUT

connector 17

LEVEL control 11

switch 11

Monitor page 222

Monitoring

- about 72
- aux sends 90
- block diagram 82
- bus outs 98
- MIDI data 238
- outputs 73
- phones 73
- stereo output 84
- TRIM 74
- using 74

Monodelay->rev 139

Motorized faders 5

Mouse

- connector 19
- function menu 30
- speed setting 213
- type 30
- using 30

MOUSE connector 19

MSB, definition 283

MTC

- counter 178
- definition 283
- input monitor 238
- receive port/channel 234

Multiport 234

Multiport MIDI setup 233

Multitrack recorders 224

Mute groups

- disabling 113
- making 113

Muting

- aux sends 93
- bus outs 99
- effects returns 124
- grouping 113
- input channels 42
- stereo output 85

N

Naming. *See* Titling

Noise gate 152

Noise gate, definition 283

Nominal Level, definition 283

Non-drop frame 181

Normal phase 39

Nyquist theorem, definition 283

O

Off-line editing, automix 193

Offset

automix 182

display 178

Omni

definition 283

MIDI 235

ON buttons

about 15

aux sends 93

bus outs 99

input channels 42

mixing layer 31

stereo output 85

Onboard dynamics. *See* Dynamics

processors

Onboard effects. *See* Effects

Onboard oscillator 212

On-the-fly fader editing 190

Operating level, definition 283

Oscillator

page 212

user define buttons 210

using 212

Output Dly page 86, 100

Oversampling, definition 283

Overwrite, automix 184

P

PAD switch

about 11

using 37

Pair page 114

PAM, definition 283

Pan

gang mode 59

inverted gang mode 59

modes 58

using 59

Pan 1-16 page 43, 59

Pan 17-24 page 59, 85

PARAMETER wheel 29

Parameters

dynamics processors 157

effects 129

selecting for automix 184

Parametric EQ 46

PCM, definition 283

Peak hold

user define buttons 210

using 79

Peak indicators 25

Peaking, definition 283

PFL, definition 283

PGM Asgn. page 239

Phantom power 37

Phase

effects 131

input channels 39

Phase page 39

PHONES connector 16

PHONES LEVEL control

about 11

Pink noise

definition 283

oscillator 212

Playing an automix 187

Port setup 233

Post fader, definition 283

POWER switch 19

pre fader, definition 284

Pre/post

aux sends 92

digital stereo out 219

effects sends 123

metering 79

Pre/post page, aux sends 92

Pre/post page, effects 123

Pre/Post page, meters 81

Prefer. page 213

Preferences 213

Presets

dynamics programs 157

effects programs 118

EQ 52

Pro Tools, MIDI Remote 249

Problems 251

Processors

dynamics 144

effects 118

Program Change

definition 284

echo 235

omni 235

recalling mix scenes 169

receive 235

scene memory assign 239

scene memory to Program

Change table 267

table dump 242

transmit 235

Programmable Mixer 01

Control Change assignments
240

MIDI Remote 245

Programs

channel 104

dynamics 144

effects 118, 125

EQ 52

ProR3, MIDI Remote 246

Protecting scene memories 170

Punch-in/out, automix 189

Q

Q

adjusting 47

definition 284

Quantization, definition 284

Quarter frame messages 181

R

Rack-mount kit 256

RCL. Safe page 174

Rear panel 16

Rec out

bus outs 98

stereo output 84

REC OUT connector 18

Recalling

automixes 203

channel programs 106

confirmation message 213

dynamics programs 149

effects programs 127

EQ programs 50

mix scenes 168

mix scenes safely 174

Receive channel, MIDI 235

Recording an automix 185

Recording solo mode 75

Rerecording automix events 188

Resetting the EQ 47

Return modes 192

Return, fader edit 190

Rev+Chorus 133

Rev+flange 134

Rev+sympho 135

Rev->chorus 134

Rev->flange 135

Rev->pan 136

Rev->sympho 136

REV500, MIDI Remote 246

Reverb hall 129

Reverb plate 129

Reverb room 129

Reverb stage 129

Reverse gate 129

Reverse phase 39

Rotary encoder 29

Routing

bus to stereo 101

effects returns 59

input channels 59

S

- Safe channels
 - automix 183
 - scene memories 174
 - solo 77
- Sample delay 40
- Sampling rate
 - definition 284
 - display 217
 - setting 217
 - synchronization 216
- Scene Mem. page 166, 168, 170, 171
- Scene memories
 - about 164
 - Bulk Dump 242
 - buttons 13, 165
 - Control Change assign 240
 - definition 284
 - display 24, 165
 - edit buffer 164
 - fade time 173
 - first in automix 179
 - memory 00 165
 - Program Change assign 239
 - protecting 170
 - recall undo 169
 - recalling 168
 - safe channels 174
 - scene memory to Program Change Table 267
 - sorting 172
 - storing 166
 - summary 7
 - titling 171
 - user define buttons 209
 - what's stored 164
- Schematic 21
- Scrolling parameter boxes 29
- Security cover 256
- SEL buttons
 - about 15
 - mixing layer 31
- Selected channel display 25
- Sending aux signals 91
- Serial mouse, definition 284
- Setup buttons 12
- Shelving, definition 284
- Signal indicators 25
- Signal to noise ratio, definition 284
- Slap, channel effect 40
- SMPTE timecode, definition 284
- Snapshot, definition 284
- Solo
 - about 72
 - button 14
 - display indicator 24
 - safe channels 77
 - setting up 75
 - TRIM 76
 - using 76
- Solo in place mode 75
- Solo Setup page 72, 75, 77
- Song Position Pointers
 - automix 181
 - definition 282
- Sonic performance 4
- Sort page 172
- Sorting scene memories 172
- Specifications
 - analog inputs 263
 - analog outputs 264
 - channel 259
 - control I/O 265
 - digital inputs 265
 - digital outputs 265
 - EQ 262
 - general 257
 - library 262
 - memory 262
 - YGDAI 265
- ST IN connector 17
- ST OUT connector 18
- Standard I/F 233
- Stereo input channel
 - balance 59
 - channel view 109
 - digital input 221
 - metering 79
 - routing 59
- Stereo link, surround pan 69
- Stereo meters
 - about 12
 - using 81
- Stereo output
 - analog outputs 84
 - balance 85
 - block diagram 87
 - channel view 110
 - delay 86
 - digital output 84
 - dynamics processors 85
 - EQ 85
 - fader setting 85
 - metering 81, 84
 - monitoring 84
 - muting 85
 - rec out 84
 - routing 84
 - YGDAI output 84
- Stereo pairs
 - aux send pan 94
 - bus outs 101
 - configuring 114
 - input channels 43
 - pan 61
 - routing 61
- Stopping automix recording 186
- Storing
 - automixes 202
 - channel programs 105
 - confirmation message 213
 - dynamics programs 148
 - effects programs 126
 - EQ programs 49
 - mix scenes 166
- Surr. 1-16 page 65
- Surr. 17-24 page 65
- Surround page 58
- Surround pan
 - 2+2 mode 63
 - 3+1 mode 63
 - 3+2+1 mode 64
 - about 62
 - CSR 69
 - outputs 62
 - selecting modes 58
 - stereo link 69
 - summary 6
 - trajectories 67
 - trajectory window 66
 - using 65
- Swapping current automix 204
- Symphonic 131
- System clock connections 218
- System Exclusive
 - definition 284
 - parameter control 241
 - setup 236
- System synchronization 216

T

- Tascam YGDAI card 223
- Termination, wordclock 218
- THD, definition 284
- Time base, automix 181
- Time counter, automix 178
- Title edit dialog box 33
- Titling
 - automixes 205
 - channel programs 107
 - dynamics programs 150
 - effects programs 128
 - EQ programs 51
 - how to 33
 - scene memories 171
- TO EDITOR connector 19
- TO HOST 235
 - baud rate 234
 - connector 19
 - data indicator 233
 - input monitor 238

Macintosh 235
 multiport 234
 operation 232
 port setup 233
 standard I/F 233
 Top panel 10
 Trajectory window, surround pan
 66
 Transmit channel, MIDI 235
 Transmit interval 242
 Transport controls, automix 178
 Tremolo 132
 Trim
 fader edit 190
 modes 192
 Troubleshooting 251

U

Undo
 automix 200
 automix buffer 201
 mix scene recalls 169
 Unity gain, definition 284
 User Def. page 208
 User define 208
 buttons 14
 display indicators 24
 User interface 24
 Using
 cursor buttons 29
 display faders 28
 display rotary controls 28
 display switches 28
 dynamics processors 146
 effects 122
 ENTER button 29
 EQ 47
 mixing layer 31
 mouse 30
 pan 59
 parameter boxes 29
 PARAMETER wheel 29
 solo 76
 surround pan 65
 title edit dialog box 33

V

Viewing channel settings 108

W

Warning messages 254
 Web site 279
 Windows PC, To HOST 235
 Wiring diagram
 2TR IN 16

AUX OUT 18
 BUS OUT 17
 inputs 1-8 16
 inputs 9-16 17
 inserts 17
 MONITOR OUT 17
 PHONES 16
 REC OUT 18
 ST IN 17
 ST OUT 18
 Wordclock
 about 216
 auto navigate 217
 distribution 218
 selecting 216
 termination 218
 WORDCLOCK connector 19
 Wordclock, definition 284
 Wordlength 220
 Write protecting scene memories
 170

X

XG tone generator, MIDI Remote
 248
 XLR inputs 16

Y

Yamaha
 web site 279
 YGDAI card 223
 YGDAI
 about 223
 block diagram 225
 bus outs 98
 card specs 223
 definition 284
 emphasis 223
 installing cards 226
 multitrack recorders 224
 output configuration 224
 output dither 220
 slot 20
 specs 265
 stereo output 84
 summary 6
 sync caution message 213
 wordclock source 216
 YGDAI Out page, meters 80



YAMAHA CORPORATION
Pro Audio & Digital Musical Instrument Division
P.O. Box 3, Hamamatsu, 430-8651, Japan