

MO802/MO1202/MO1602

OPERATING MANUAL

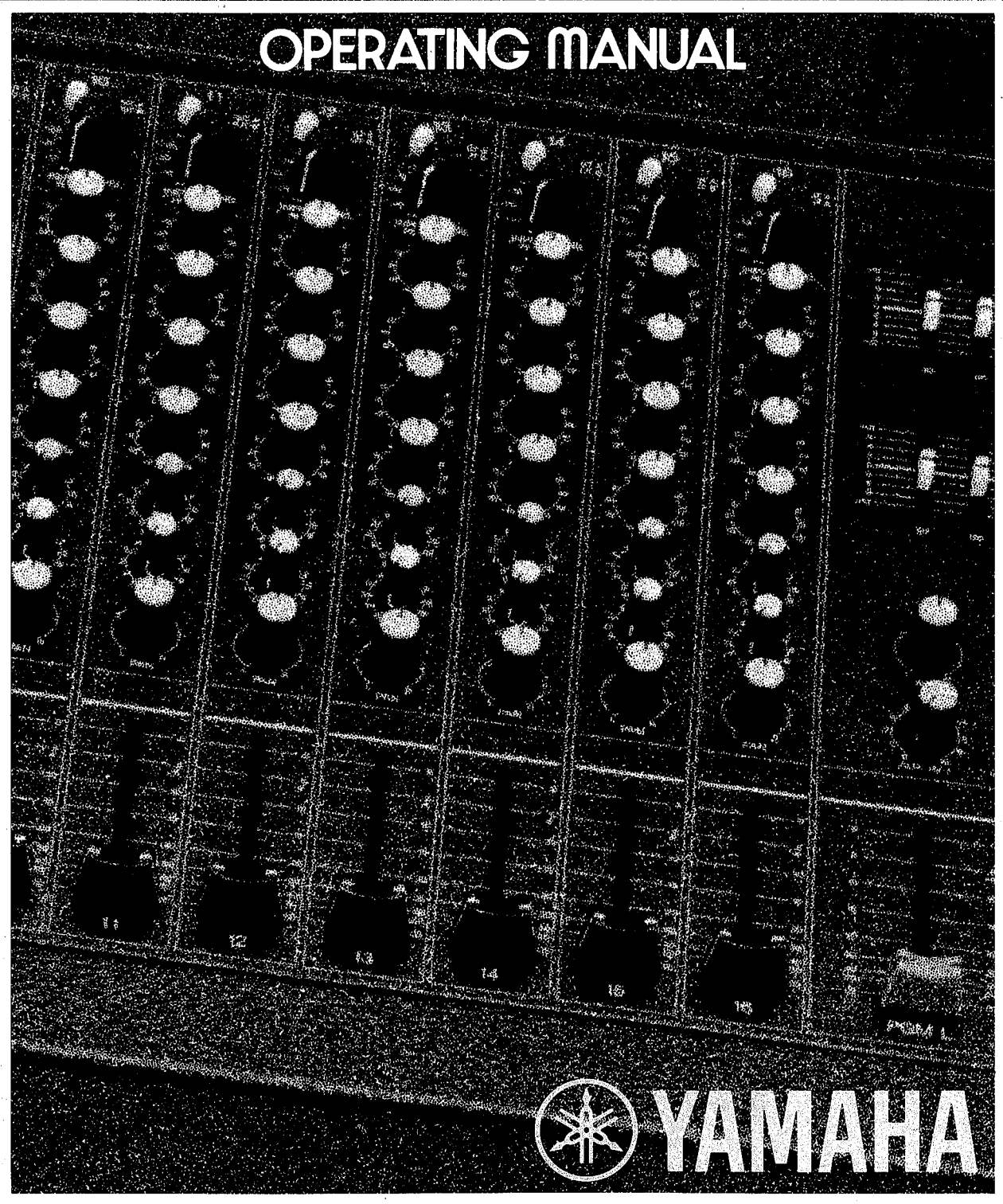

YAMAHA

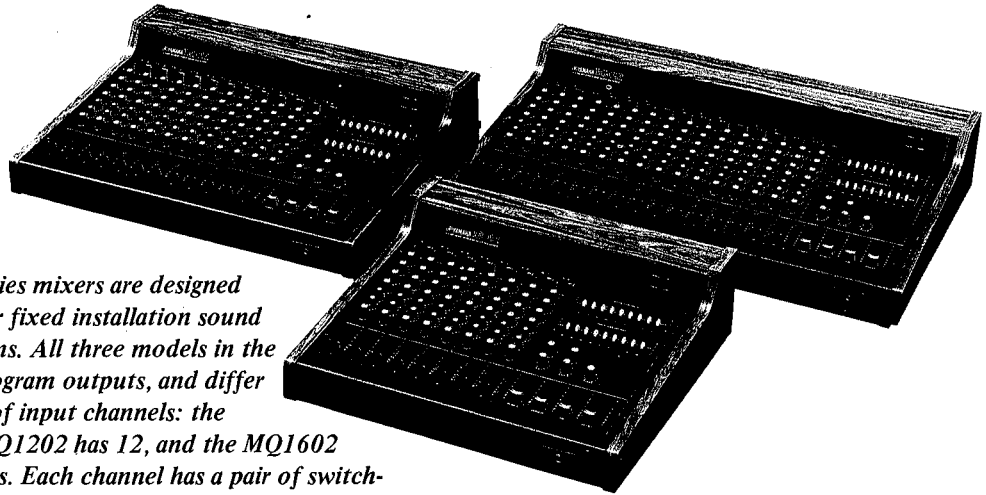

The Yamaha MQ-Series mixers are designed for use in portable or fixed installation sound reinforcement systems. All three models in the series have stereo program outputs, and differ only in the number of input channels: the MQ802 has 8, the MQ1202 has 12, and the MQ1602 has 16 input channels. Each channel has a pair of switch-selectable inputs, one XLR-type connector and one phone jack, either of which is usable with mic or line level sources. There are 4 mixing busses: program left and right, echo, and foldback. The program outputs are both equipped with 9-band graphic equalizers, useful for increasing the available sound system gain before feedback, and for making overall tonal adjustments to the program. MQ-Series mixers are ideal for use in cabarets or nightclubs, as well as for concerts, school productions, trade shows, and small theatrical productions. Because the mixing busses all have sub-inputs, two or more mixers can be linked to obtain more input channels and sub-group capability. The mixers are designed for easy interface with other equipment. Each channel input has both a low impedance XLR-type connector and a high impedance phone jack, each of which is switchable for nominal levels from -60 to $+4\text{dB}$ (0dB ref. 0.775V rms). The program outputs are brought to both balanced XLR-type connectors and unbalanced phone jacks, with $+18\text{dB}$ maximum level. And the echo/effects output is brought to two phone jacks, providing a choice of $+4\text{dB}$ and -20dB nominal levels. Auxiliary inputs are able to accept nominal levels from -32dB to $+4\text{dB}$. Thanks to this added flexibility built into the mixers, external pads and transformers are seldom required. Other features include dB -calibrated faders, bar graph style peak-indicating meters on the outputs, and peak LEDs on the inputs. Each input channel also has 4-band equalization. Internally the mixers offer the convenience of modular plug-in circuitry, and outside a solid front panel adds to strength and durability. To take full advantage of your MQ-Series mixer, please read this manual carefully.

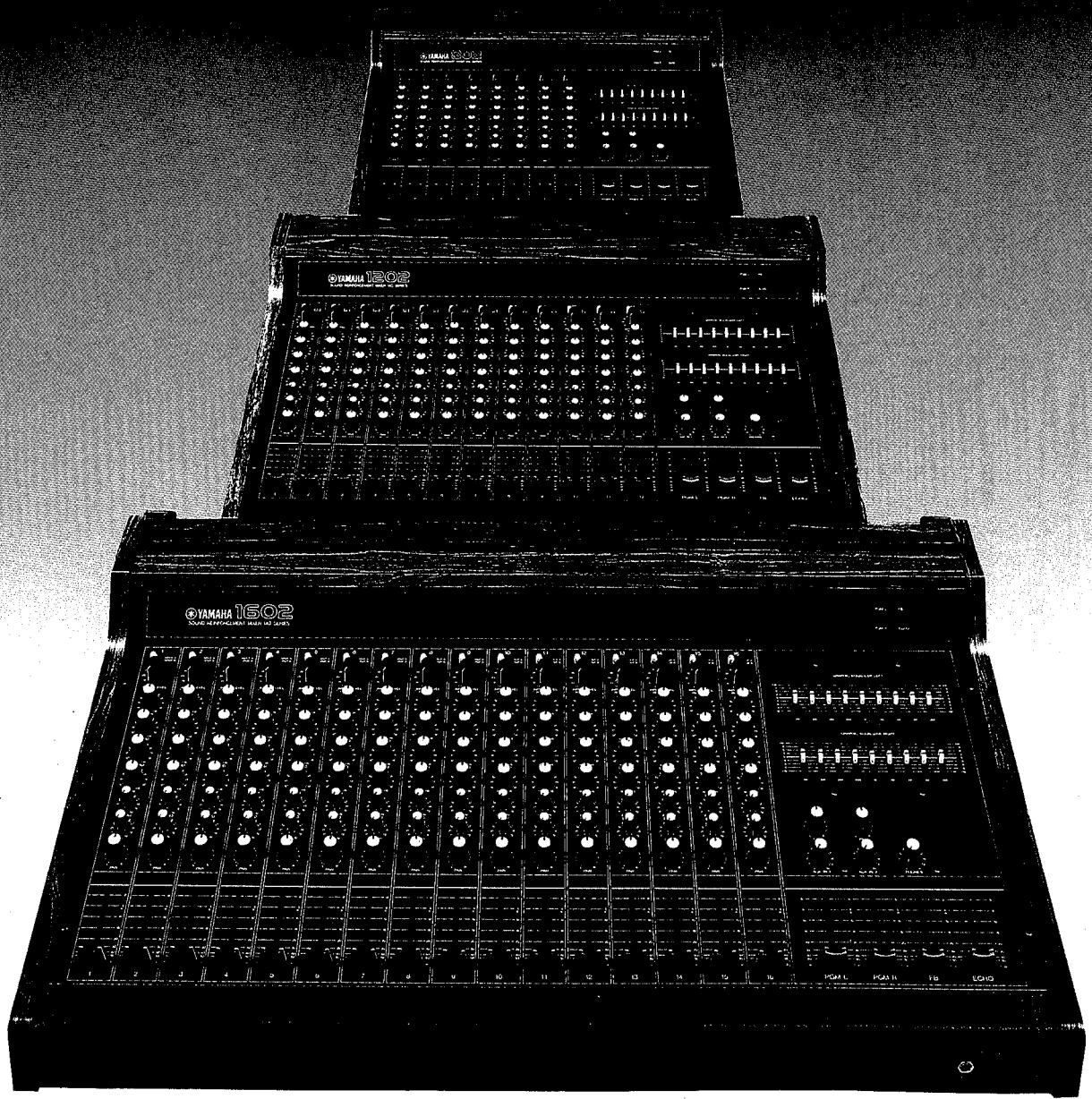

CONTENTS

OPERATING INSTRUCTIONS-FRONT PANEL

Input Channels	1
Output Section	3
Auxiliary Input Section	4
Meters	4

INSTALLATION AND REAR PANEL FEATURES

Rear Panel Features	5
Hook-up Cables and Hum Avoidance	6
More About the Theory of Grounding	7
Mixer Placement	7

APPLICATIONS

The MQ1602 as the Main Mixer in a Club/Cabaret Sound System	8
Linking the MQ802 and MQ1202 to Obtain 20 Input Channels	9
Using the MQ802 as a Keyboard Mixer	10
Using an MQ-Series Mixer for Occasional Mult-Track Recording	11
More About the Graphic Equalizers	12

SPECIFICATIONS

General Specifications	13
Input/Output Specifications	14
Equalizer Characteristics	14
Block Diagram	15
Level Diagram	16

HOW TO CONNECT MULTI-CONNECTOR (ACCESSORY) & CABLE

MAINTENANCE & SERVICE

WARNING: TO REDUCE THE RISK OF FIRE OR ELECTRIC SHOCK, DO NOT EXPOSE THIS APPLIANCE TO RAIN OR MOISTURE. THERE ARE NO USER-SERVICEABLE PARTS INSIDE. REFER SERVICING TO A QUALIFIED SOUND EQUIPMENT TECHNICIAN.

OPERATING INSTRUCTIONS-FRONT PANEL

INPUT CHANNELS

NOTE: It is not necessary that you be able to read a block diagram in order to understand and use this mixer. However, the block diagram on page 15 can be thought of as a "road map" to the mixer, one that can give you an overview as you read the following descriptions.

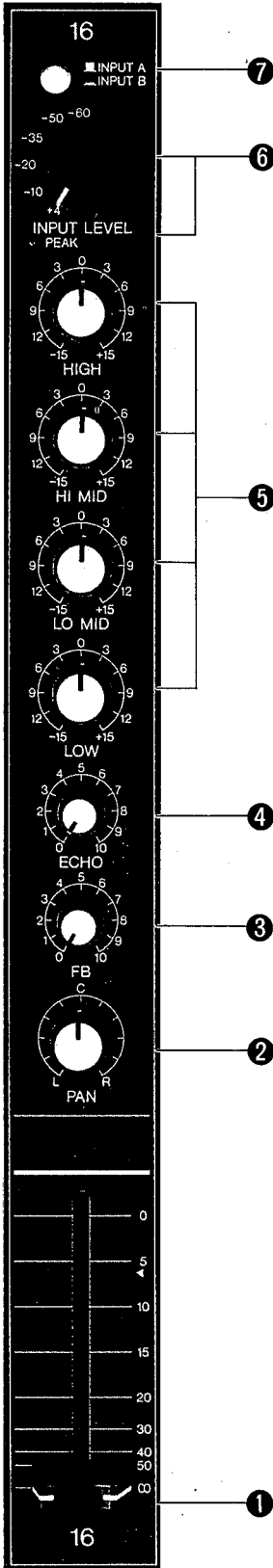

1 CHANNEL FADER

The Fader continuously varies the channel output level to the Left and Right program mixing busses. It also affects the channel's Echo bus send, but not Foldback. The nominal setting is "-6" position, as indicated by an arrow on the dB-calibrated scale. When the input signal is equal to the level set with the Input Level switch, setting the Fader at nominal position applies the optimum signal level to the mixing busses; if the Master Fader is also at nominal, the program output level will be +4dB.

2 PAN POT

This rotary control assigns the channel Fader output to the stereo program mix busses, anywhere from all the way Left to all the way Right. Centering the Pan pot places the signal equally in both busses (the acoustic "image" is centered); at this point, each bus is fed a signal 3dB below the maximum full-Left or full-Right panned level. This ensures that the combined stereo output power remains constant in any Pan pot position.

3 FOLDBACK MIX LEVEL CONTROL (FOLDBACK SEND LEVEL)

The channel's FB control adjusts the amount of signal applied from the channel to the Foldback mixing bus. Since the FB send is pre-Fader and pre-Equalizer, Fader and EQ adjustments do not affect the foldback mix. FB is useful for driving stage monitor amplifiers and speakers, but may be used for effects, remote feeds, etc. Nominal setting is approximately 8 to 9 on the control scale, although lower settings are often used, as required by the mix.

4 ECHO MIX LEVEL CONTROL (ECHO SEND LEVEL)

The channel's Echo control adjusts the amount of signal applied from the channel to the Echo mixing bus. Since the Echo send is post-Fader and post-Equalizer, Fader and EQ adjustments also affect the echo mix. The echo mix can be used to drive a variety of external time delay units, including echo chambers, reverb, and analog or digital delay lines. It also may be used to drive special effects devices such as phasers and flangers. Nominal setting is approximately 8 to 9 on the control scale, although lower settings are often used, as required by the mix.

5 EQUALIZER (EQ)

Each input channel Equalizer can be adjusted for up to 15dB of boost or cut at four different frequency ranges. The controls are calibrated in dB, centering them at the "0" position establishes flat audio response.

The LOW control provides shelving type equalization with a knee at 100Hz.

The LO MID control provides peaking type equalization centered at 500Hz.

The HI MID control provides peaking type equalization centered at 3kHz.

The HIGH control provides shelving type equalization with a knee at 10kHz.

In many mixes, EQ is used to modify tonal characteristics for better separation (i.e., given similar-sounding instruments on two channels, you might boost one channel's HI MID control and boost the other's HIGH control). EQ can be used to correct certain acoustic imbalances, such as using HIGH boost to liven up a "dead" room, or LOW cut to avoid the boominess in some rooms. Another use of EQ is to avoid leakage and excess noise without significantly changing the sound. For example, if a bass drum is the only sound on a given channel, you might wish to cut the HIGH control and thus eliminate background hiss as well as leakage from high frequency instruments such as strings; since bass drums don't produce much high frequency sound, the EQ will not drastically change the instrument's sound.

⑥ INPUT LEVEL SWITCH AND LED PEAK INDICATOR

The Input Level switch changes the input sensitivity to accommodate nominal input levels of -60 , -50 , -35 , -20 , -10 or $+4$ dB. Respectively, these levels correspond to low level dynamic or ribbon mics, medium and high level condenser mics, preamplified electric instruments, and low or high line level audio processing or mixing equipment.

Adjacent to the switch is a red LED indicator that helps the operator determine the proper Input Level setting. The LED turns On before the preamplified input signal is high enough to cause overdrive distortion (i.e., whenever the level exceeds 3dB below clipping).

To establish the Input Level switch setting that yields the best combination of maximum headroom and minimum noise characteristics, first set the switch to $+4$ dB position. Then apply a typical input signal to that channel (e.g., talk or sing into the microphone, play the instrument to which the channel is connected, etc.). Turn the Input Level switch to more sensitive settings (toward the -60 " end of the scale) until the red LED flashes only occasionally. If the red LED flashes often or stays On, reduce the Input Level switch sensitivity (turn it up toward the $+4$ " end of the scale).

NOTE: The input Fader has no effect on this LED. The LED monitors the level after the Input Level switch, but before the Fader.

⑦ INPUT SELECTOR PUSHBUTTON (A-B)

Two separate inputs are provided for each channel, a low-impedance XLR-type connector (input "A") and a high impedance phone jack (input "B"). The Input Selector pushbutton determines which of the channel's two XLR-type connectors, A or B, actually supplies the audio signal to the channel. (The Input Level switch sets the sensitivity of both inputs.)

To select the XLR-type connector, the button should be up; to select the phone jack, press the button down.

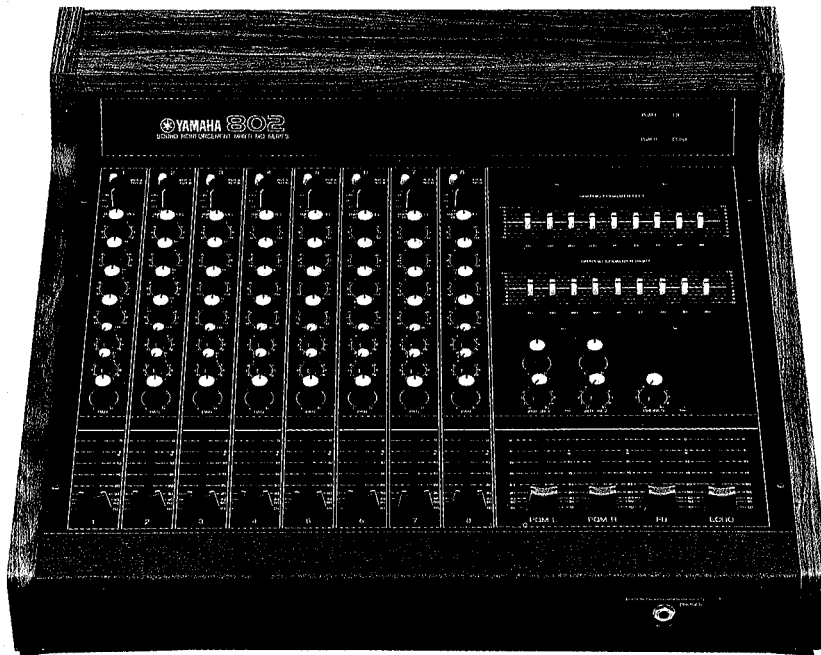

OUTPUT SECTION

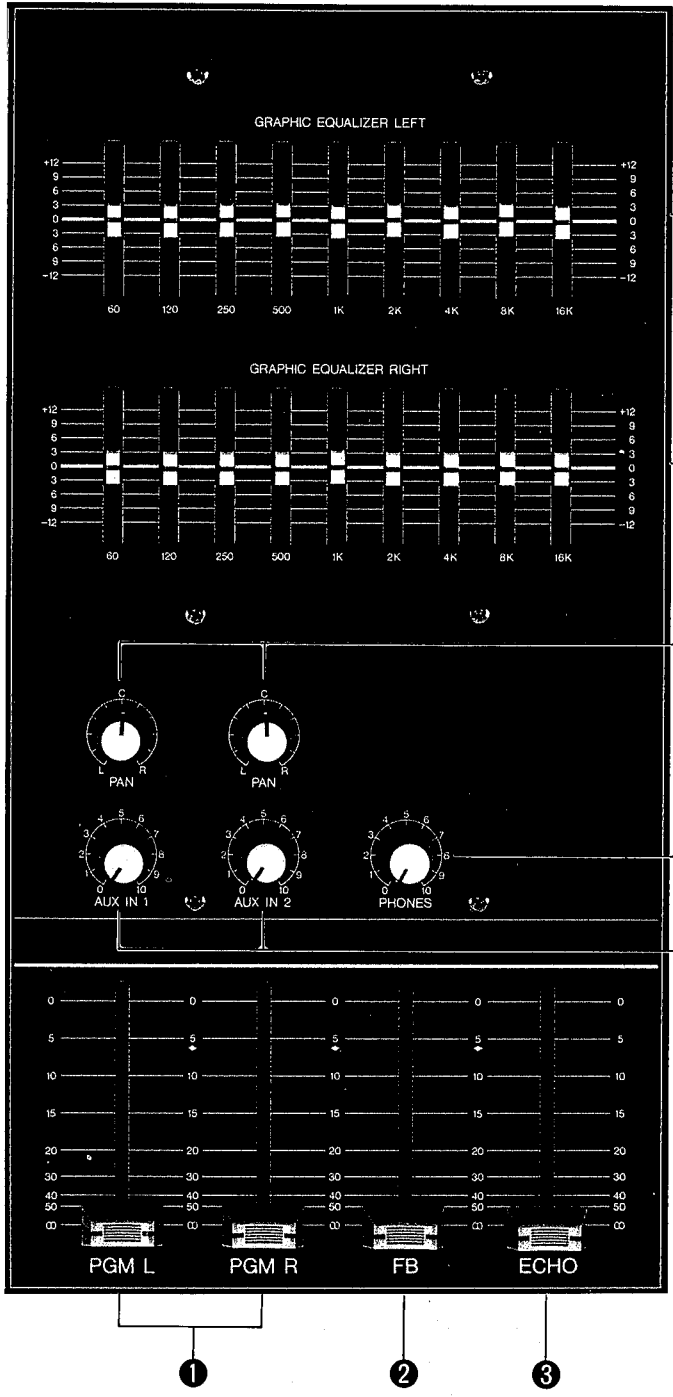

1 PGM L AND PGM R MASTER FADERS

These Master Faders adjust the overall level of their respective Left and Right Program mixing busses prior to feeding the Program outputs. The Master Faders control all signals assigned by the channel Pan controls, Aux In Pan controls and Program Sub Inputs. The nominal Fader setting is “-6dB”, as indicated by an arrow on the control scale.

2 FOLDBACK MASTER FADER

This Master Fader adjusts the overall level of the Foldback mix bus, including all signals from the channel FB mix controls and FB Sub Inputs, prior to feeding the Foldback output. The nominal Fader setting is “-6dB”, as indicated by an arrow on the control scale.

3 ECHO MASTER FADER

This Master Fader adjusts the overall level of the Echo mix bus, including all signals from the channel Echo send controls and Echo Sub Inputs, prior to feeding the Echo output. The nominal Fader setting is “-6dB”, as indicated by an arrow on the control scale.

4 HEADPHONE LEVEL CONTROL

This rotary control simultaneously adjusts the volume in the left and right earpieces of any stereo headphones which are plugged into the Headphone jack. The phones are fed the stereo program, although headphone volume is independent of the level set with the PGM Master Faders.

NOTE: The Headphone output, not illustrated here, is a standard 1/4" (6.3 mm) stereo phone jack on the right front edge of the mixer. It will drive conventional 8Ω or higher impedance stereo phones. This jack also can be used to drive a power amplifier and monitor speakers (a splitter cable would be necessary to drive the left and right amplifiers from the stereo jack).

5 GRAPHIC EQUALIZERS

The program outputs each have a 9-band graphic equalizer with slider-type controls whose position visually approximates the frequency response curve that is being created (hence, the term "graphic"). These sliders function much like the LO MID and HI MID channel EQ, except they operate over narrower bands centered at 60, 120, 250, 500, 1k, 2k, 4k, 8k, and 16kHz. The sliders provide up to 12dB of boost or cut, and have a detent at "0" position so they are easier to set for "flat" response.

Graphic equalization can be used to control acoustic feedback, thus increasing the available gain in a sound system, or to add desired tonal color to the program. At extreme settings, graphic EQ can produce unusual effects. The FB and Echo outputs are not affected, so EQ corrections on the "house" sound will not change the sound fed to the stage monitors or effects devices. The graphic equalization can be heard in the Headphone output.

AUXILIARY INPUT SECTION

The two Auxiliary Inputs may be used as line inputs for a stereo program or two different mono sources. Alternately, they may be used to "return" to the program mix any echo/reverb or other effects that were "sent" out of the mixer's echo or foldback outputs. Each Aux Input (1 and 2) is provided with a set of Aux In Level and Aux In Pan controls.

6 AUX IN LEVEL (1 & 2) CONTROLS

These rotary controls adjust the level of the incoming signal from their corresponding Aux Input jacks.

NOTE: The nominal sensitivity of each Aux Input is -20dB . However, turning down this control permits higher level sources to be accommodated ($+4\text{dB}$ nominal); conversely, turning up the control increases sensitivity for lower level sources (-32dB nominal).

7 AUX PAN (1 & 2) CONTROLS

These two controls adjust the assignment of their respective Aux Inputs to the Left and Right PGM mixing busses. If the two inputs are used to accept a stereo program, pan one control fully clockwise (CW) and the other fully counter-clockwise (CCW).

METERS



1 PEAK-INDICATING BAR GRAPH METERS

A pair of horizontal fluorescent meters display the peak output level. Levels from -20dB to -1dB are indicated in blue-green color, and levels of 0dB to $+8\text{dB}$ are indicated in red, ensuring good visibility; a gradual decay allows operator to clearly detect very brief peaks. The mix level should be set so the meters occasionally reach full scale, with typical peaks from 0dB to $+5\text{dB}$.

2 PGM L/FB OUTPUT METER SWITCH

This switch determines whether the upper meter displays the Left Program output or the Foldback output level.

3 PGM R/ECHO OUTPUT METER SWITCH

This switch determines whether the lower meter displays the Right Program output or the Echo output level.

INSTALLATION AND REAR PANEL FEATURES

REAR PANEL FEATURES

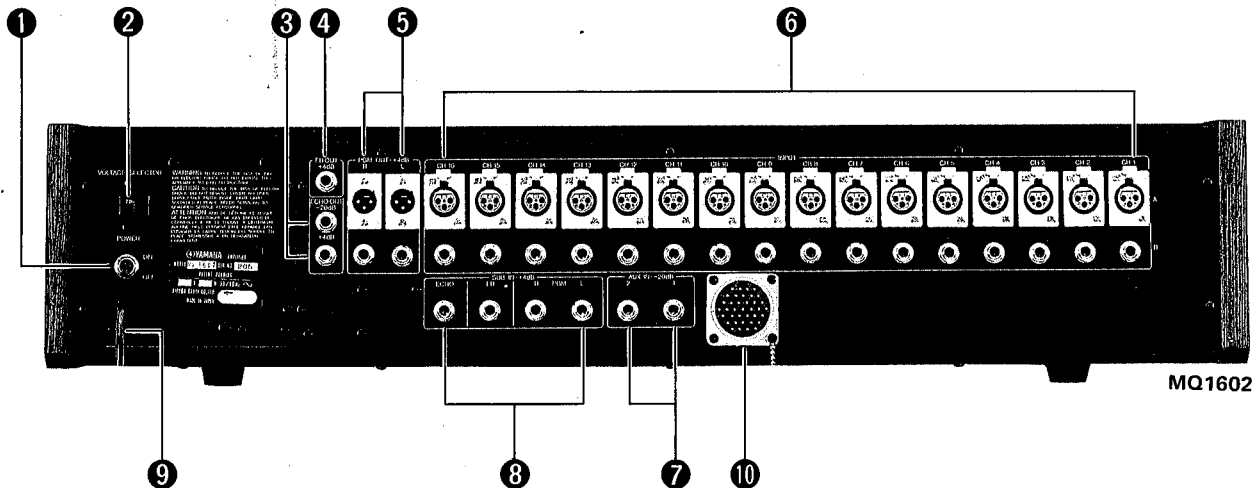

NOTE: All XLR-type connectors are wired as follows: pin 2 = signal high, pin 3 = signal low, pin 1 = shield. The MQ802 and MQ1202 are nearly identical, except for the number of input connectors and multi-pin connectors.

1 AC POWER SWITCH

2 AC VOLTAGE SELECTOR

These switches select the appropriate AC power line voltage (100, 120, 220 or 240V) according to the area where the mixer is being used. Be sure to set the selector to your local line voltage before switching on power to the mixer.

3 ECHO OUTPUTS (-20 and +4)

These post Echo Fader outputs are unbalanced 1/4" (6.3 mm) standard phone jacks, both carrying the same signal. The difference is that the lower jack has a +4dB (1.23V rms) nominal level, and the upper jack is -20dB (78mV rms). The actual source impedance of both jacks is 130Ω, so they will drive 600Ω or higher impedance loads, including almost all echo and reverb units (except those units meant for connection to a guitar pickup). If echo or other effects are not required, Echo Out may be used for foldback to stage or dressing rooms, or for making a mono tape recording.

4 FB OUTPUT

This post Foldback Master Fader output is an unbalanced 1/4" (6.3 mm) standard phone jack with +4dB (1.23V rms) nominal level. The actual source impedance is 130Ω, so the output will drive 600Ω or higher impedance loads, including virtually all professional graphic equalizers, electronic cross-overs, and power amplifiers.

5 PGM OUT L & R OUTPUTS

The Left and Right Program outputs each have two connectors, a male XLR-type connector and a standard phone jack. The post PGM L and PGM R Master Fader signal is fed to the XLR-type connectors via transformers, so the outputs are balanced (actually floating); the phone jacks are unbalanced. The nominal level of all PGM outputs is +4dB (1.23V rms), and the actual source impedance is 130Ω, which means these outputs will drive 600Ω or higher impedance loads, including virtually all professional graphic equalizers, electronic cross-overs, power amplifiers, and tape recorders.

6 CHANNEL INPUTS (x 8, 12 or 16)

Each channel is equipped with both an unbalanced standard 1/4" (6.3 mm) phone jack and a balanced, transformer-isolated female XLR-type connector. The active connector, XLR-type connector or phone jack, is determined with the channel's front panel Input Selector switch. The active input applies nominal -60dB (0.78 mV rms) to +4dB (1.23V rms) signals to the respective input channels; nominal level is set with the Input Level switch.

The XLR-type connectors are low impedance (actual load varies with Input Level setting from 800Ω to 2.6kΩ). The XLR-type connectors therefore accommodate nominal 50 to 250Ω (low impedance) professional microphones as well as 600Ω line level sources. The phone jacks are high impedance (actual load varies from 25kΩ to 54kΩ), and thus accommodate nominal 50Ω to 50kΩ microphones as well as 600Ω or higher impedance lines.

⑦ AUX INPUTS (1 and 2)

These standard 1/4" (6.3 mm) phone jacks are unbalanced inputs that apply signal to the Left and/or Right Program mixing busses via the respective Aux 1 & 2 Level controls and Pan Pots. Actual input impedance is 25k Ω , and nominal level is -20dB (78mV rms), although the Aux Level control can be adjusted for nominal levels as low as -32dB or as high as +4dB. The inputs are intended for nominal 600 Ω or higher impedance sources, such as the return from echo or reverb devices, the output of a tape recorder, or the line output of another mixer.

⑧ SUB IN JACKS (PGM L, PGM R, FB, ECHO)

NOTE: While the Sub Inputs feed different busses (PGM L, PGM R, FB, and ECHO), the functions are essentially identical for all Sub In jacks.

These standard 1/4" (6.3 mm) phone jacks are unbalanced inputs that apply a nominal +4dB (1.23V rms) signal to the respective Program, Foldback and Echo mix busses via internal isolation/attenuation pads. Actual input impedance is 1k Ω , and the inputs are intended for nominal 600 Ω sources.

Sub Inputs may be used for linking the program, foldback and/or echo outputs of another mixer to this MQ mixer for expansion of the mixing system, or for applying any suitable line-level source(s) to the mixer subject only to the mixer's Master Faders. A common use of the PGM Sub Inputs, for example, is to play back a stereo program from a tape recorder (for set up or during intermission) without "using up" input channels.

⑨ AC POWER CORD

This AC power cord (grounded type) connects to suitable 50 or 60Hz AC mains. Refer to the mixer specifications (page 13), or the label on the mixer's rear panel, for specific line voltage and power requirements.

The mixer should be AC grounded for safety and for optimum shielding against noise; a 3-conductor power cable is provided for this purpose. If a 3-wire AC outlet is not available, or if there is any chance the AC outlet may not be grounded, a separate jumper wire must be connected from the mixer chassis to an earth ground. Cold water pipes generally provide good grounds unless they are insulated by a length of PVC (plastic) pipe or a water meter. (An electrical wire bypasses some water meters, supplying ground continuity for the cold water pipes.) Avoid hot water pipes and gas pipes. When in doubt, use a length of copper pipe driven into moist, salted earth, burying at least 1.5 meters (5 feet) of pipe; alternately, use a chemical type ground rod.

⑩ MULTI-PIN "SNAKE" CONNECTOR

This connector (available only on the MQ1602) permits convenient input of multiple microphone and line sources from the stage via a "snake": a compound cable that carries multiple transmission lines from a multi-input junction box on stage. This capability eliminates the mess and inconvenience of having to run individual lines from each source to the mixer inputs.

Hook-up Cables and Hum Avoidance

The mixer's primary input and output circuits are equipped with transformer-isolated XLR-type connectors and phone jacks. When the XLR-type connectors are used with the appropriate 2-conductor shielded cables (e.g., standard microphone cables), these circuits afford the optimum protection against hum, buzz, and other noise pick-up.

The XLR-type connectors are wired with pin 2 as "audio high" and pin 3 as "audio low", in accordance with DIN and JIS standards. Some professional equipment and microphones are wired with pins 2 and 3 reversed; generally this will cause no problem, other than a polarity reversal. However, if such a piece of equipment uses an XLR-type connector for an unbalanced input, or if an MQ-Series mixer's XLR-type connector is connected, via an adapter cable to an unbalanced phone jack, the "high" side of the audio circuit could be grounded. In this case, invert the wiring of pins 2 and 3 in one XLR-type connector of the interconnecting cable (or use a suitable polarity-reversal adapter). Regardless of XLR-type connector polarity, if hum is encountered try cutting the shield connection at one end of the cable.

All phone jacks (except the stereo headphone jack) are intended for use with standard tip/sleeve 1/4" (6.3 mm) phone plugs and single-conductor shielded cable. Hum reduction should not be attempted by cutting the shield on these cables. Instead, restrict unbalanced cables to about 10 feet (3 meters), and try to set up the system so that either (a) the equipment involved is all connected to the same AC circuit, or (b) the third-wire AC mains ground is used on only one piece of equipment, typically the mixer. Remember, breaking a ground path can create a shock hazard.

When routing any cables, especially unbalanced cables, avoid strong sources of electro-magnetic interference (EMI) or radio frequency interference (RFI) such as electric motors, fluorescent lights, dimmer panels, and so forth. To avoid crosstalk-induced feedback, never bundle microphone input cables with mixer output cables; these cables should cross at right angles where practical.

More About the Theory of Grounding

Careful grounding procedures are essential for proper operation, not only of the mixer, but of the entire audio system. Many grounding techniques exist, and certainly there are several ways to achieve a satisfactorily grounded audio system. Several books have been written on the subject. For further information, consult the following sources: **THE AUDIO CYCLOPEDIA** by Howard M. Tremaine (Pub. Howard W. Sams); **SOUND SYSTEM ENGINEERING** by Don and Carolyn Davis (Pub. Howard W. Sams); **GROUNDING AND SHIELDING IN INSTRUMENTATION** by Ralph Morrison (Pub. John Wiley & Sons).

Ground loops (also called "hum loops"), are often caused by multiple paths from equipment grounds to the AC main ground (or "earth" ground). Ground loops tend to induce hum and allow noise to develop in an audio system. In severe instances, equipment may begin to oscillate due to ground loops. This oscillation can cause distortion and even damage to amplifiers and loudspeakers. One way to avoid ground loops is to make sure that there is just one path to the AC ground (earth ground) for the entire audio system. One popular method, though not necessarily the best or only one, is to cut the shield ground of XLR-type connector cables at the input side of the cable. Another technique is to ground all shields at one piece of equipment, typically the mixer, and to cut the shields at the other ends of the cables. (With unbalanced phone jack cables, the shield must be connected at both ends.)

Connect the mixer to the power mains **ONLY AFTER CONFIRMING THAT THE VOLTAGE AND LINE FREQUENCY ARE CORRECT.** (By all means, **USE A VOLTMETER** . . . it can save your equipment and the show.) It is also a good idea to check for proper polarity in the AC outlet. The Power switch on the mixer should be Off before connecting the mixer to the mains. As a further precaution, disconnect the mixer from the mains while audio cables are being installed.

Mixer Placement

The MQ-Series are fully portable, self-contained mixers built in a hard, attractive case. Your mixer may be placed on a table top or a shelf at any convenient working height, or it can be recessed for permanent, low profile mounting. Whether recessed, or table top mounted, the mixer should be on a level surface, with sufficient rear panel clearance for the input and output cables.

For touring, a sturdy travel case should be constructed, with adequate padding to prevent damage to the mixer in the event it is dropped or handled roughly.



WARNING

In any audio system installation, governmental and insurance underwriters' electrical codes must be observed. These codes are based on safety, and may vary in different localities; in all cases, local codes take precedence over any suggestions contained in this manual. For this reason, Nippon-Gakki (Yamaha), or its agents cannot accept liability for incidental or consequential damages, including injury to persons or property, resulting from improper, unsafe or illegal installation or use of the MQ-Series mixer or of any related equipment. Neither can the aforementioned parties accept liability for any such damages arising from defects or damage resulting from accident, neglect, misuse, modification, mistreatment, tampering or any act of nature.

APPLICATIONS

The following are but a few of the many ways the MQ-Series mixers can be used. While we have illustrated the MQ802, MQ1202 and MQ1602 in specific sound systems, any of these mixers may be interchanged. As you become familiar with your mixer, you will undoubtedly devise your own unique setups and operating techniques.

The MQ1602 as the Main Mixer in a Club/Cabaret Sound System

Microphones and preamplified electric instrument outputs can be connected to the channel inputs. A direct box is inserted between an instrument amplifier's speaker-level output and the mixer's channel input. In situations where a high impedance source (mic or line) is used by one performer, and a low impedance source by a subsequent performer, the two sources can both be connected to a single channel's inputs; the Input Selector switch can then be used for rapid changeover between the sources. This extends the input capacity and avoids the need to unplug and reconnect cables.

The system illustrated uses a single channel of foldback (with optional external graphic EQ), and has both a reverb and a delay line; only one effect at a time is used, with the unused effect being turned off via its Aux In level control. If echo/reverb needs are minimal, the Echo bus

can be used for an additional foldback mix.

The sound system illustrated is stereo, with Left and Right program outputs driving identical amplifiers and speakers. In a monaural sound system, the two program outputs can be used differently. For example, PGM L can be used for the house feed, while PGM R is used for a second foldback or echo/effects mix. In larger monaural sound systems, one program output can be used for the "near stage" amplifier cluster, and the other for a more distant speaker cluster (the distant speakers would include a delay line between the mixer and amplifier to keep the acoustic image located on stage).

Note that the Program Sub Inputs can be used as auxiliary line inputs for playing a stereo tape recording (or a preamplified record). This setup does not detract from the available input channels, and is useful during setup, or for playing background music during an intermission.

Using the MQ1602 as a main mixer for a club/cabaret sound system.

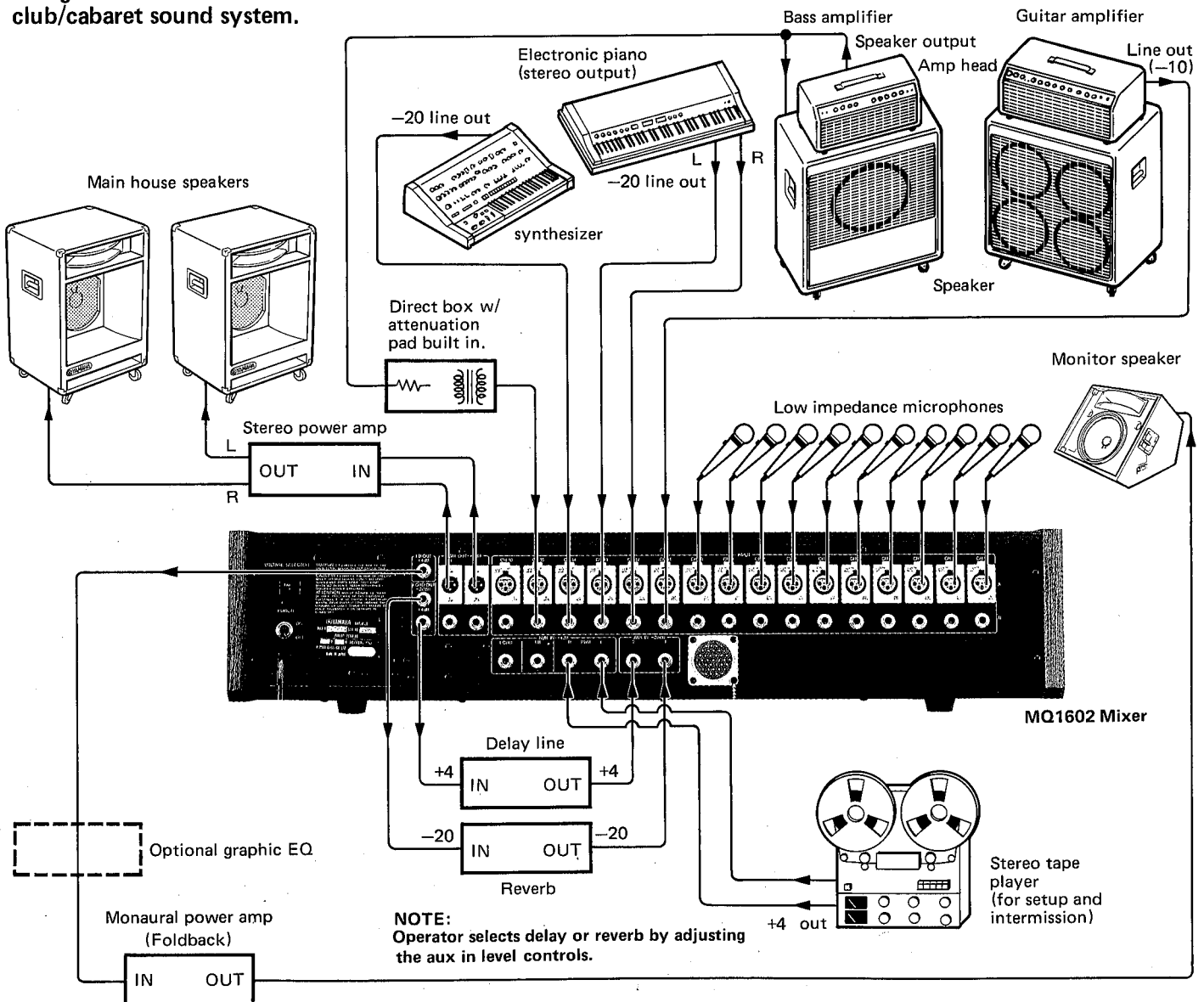

Linking the MQ802 and MQ1202 to Obtain 20 Input Channels

As in the preceding application, microphones and preamplified electric instrument outputs can be connected to the channel inputs. The advantage to this setup is that more total inputs are available. For example, the MQ802 and MQ1202 shown provide a total of 20 input channels; two MQ1602s would provide 32 inputs, and so forth. More than two mixers can be linked, although noise is cumulative, and thus may become objectionable.

There are a few ways to link the mixers. The approach illustrated connects the PGM outputs of the MQ802 to the PGM sub inputs of the MQ1202. Reversing the signal flow, the MQ1202's Echo and FB Outputs are connected to the respective MQ802 Sub Inputs. Cross-linking in this manner establishes the MQ802's Echo and FB Master

Faders as the Grand Echo and FB Masters, while the MQ1202's PGM Master Faders serve as the Grand PGM Masters. In this case, the MQ802's output Meters are switched to Echo and FB, while the MQ1202's Meters are switched to PGM L and PGM R, so all four outputs are simultaneously metered.

If desired, the mixers can be linked in one direction; e.g., the MQ802's PGM, Echo and FB Outputs are connected to the MQ1202's Sub Inputs. Simultaneous metering capability is lost, but all Grand Master Faders are now located together on the MQ1202. At the same time, the Master Faders on the MQ802 can function as sub-group masters, provided that a group of related inputs is connected to that mixer.

Linking two MQ-series mixers to create a larger mixing system.

NOTE:

The program, FB and Echo outputs of one mixer can be connected to the respective sub inputs of the other mixer. This prevents simultaneous metering of all four outputs, but permits the one mixer's master faders to serve as sub masters for convenient sub grouping.

NOTE:

Switch these meters to FB and ECHO. FB and ECHO master faders control respective outputs.

NOTE:

Switch these meters to PGM L and R. PGM L and R master faders control respective outputs.

NOTE:

Set PGM master faders at nominal level and use other mixer's PGM master faders for mixing.

NOTE:

Set FB and ECHO master faders at nominal and use other mixer's ECHO and FB faders for mixing.

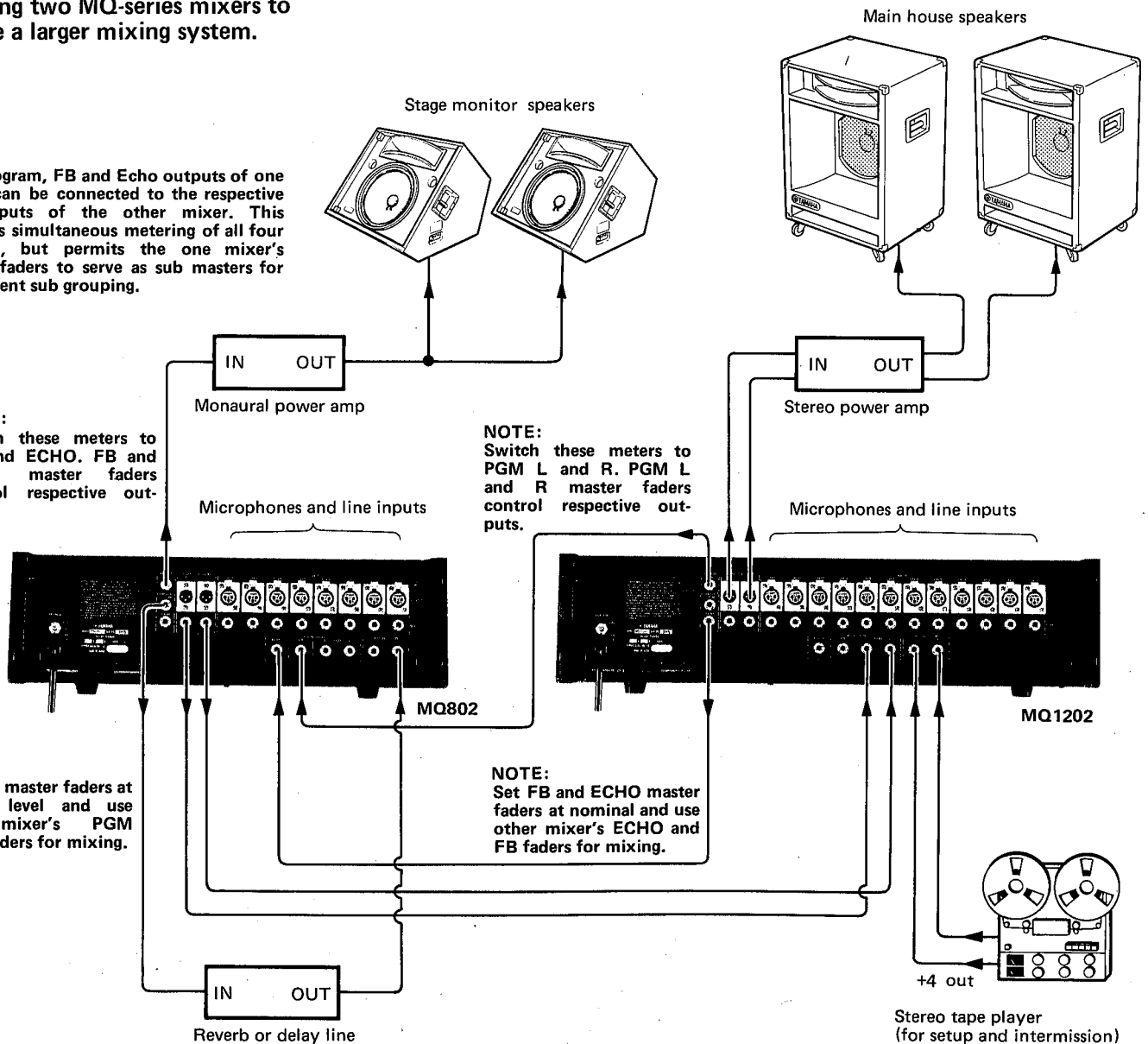

Using the MQ802 as a Keyboard Mixer

Today's keyboard performers often use as many as half a dozen instruments for a single performance. Many such performers insist on the added control they obtain by setting their own mix levels and EQ; this keyboard sub-mix drives local monitor speakers for the keyboard performer, and is also fed to the main house sound system. Many electric keyboard instruments have high impedance unbalanced inputs. These would tend to suffer high frequency losses and

increased noise when feeding a distant house mixer, unless a balancing and impedance lowering transformer were used. However, when the MQ mixer is used as an on-stage keyboard mixer, the unbalanced instruments' outputs are converted to balanced, low impedance lines at the MQ mixer's XLR-type connector PGM outputs, saving the cost and complexity of individual direct boxes. (The MQ mixer's phone jack outputs are used to drive the monitor amplifier, which is located nearby.)

Using the MQ802 as a keyboard mixer.

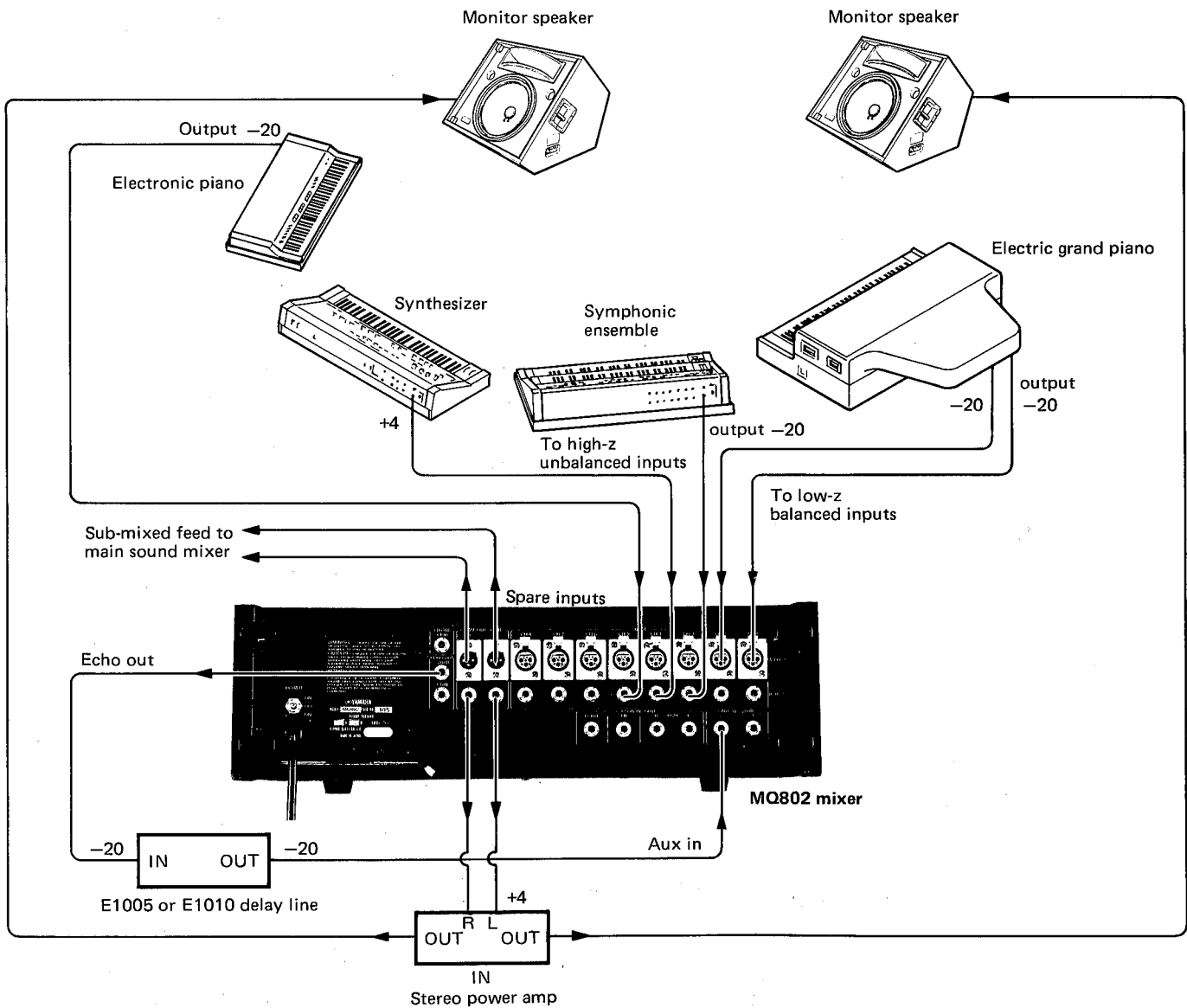

Using an MQ-Series Mixer for Occasional Multi-Track Recording

The MQ-Series mixers are intended for use in sound reinforcement systems, and are not equipped with many of the essential features of a true recording mixer. However, if you already own the MQ mixer, you may wish to use it for informal recording work (such as laying down synthesizer parts on a multi-track recorder). The setup illustrated shows an MQ802 with its Left and Right PGM Outputs being patched into pairs of tracks on an 8-track recorder. The line outputs from all 8 tracks are patched into the MQ input channel phone jacks, while one or more of the mixer's XLR-type connector inputs accept the live instrument(s) or microphone(s).

Initially, two tracks are recorded; subsequently, the mixer channels corresponding to the recorded tracks are switched to the phone jack inputs to pick up synchronous playback, and the PGM Outputs are

patched into another two tracks of the recorder. This process continues until the multi-track tape is completed (track-to-track transfers can be done in a similar fashion).

Finally, the multi-track tape is played with all mixer inputs switched to the phone jacks, and the PGM Outputs are plugged into a stereo master recorder; the mixdown is thus completed.

In this system, the Foldback bus can be used to do a mono mix of all previously recorded tracks, and the FB output is then fed to an amplifier and either a speaker or headphone distribution system. This provides monitoring for a performer(s) during overdubs. The recordist or mixer operator can monitor the program with either headphones plugged into the mixer front edge, or with a stereo amplifier and speakers.

Using MQ mixer for occasional multi-track recording.

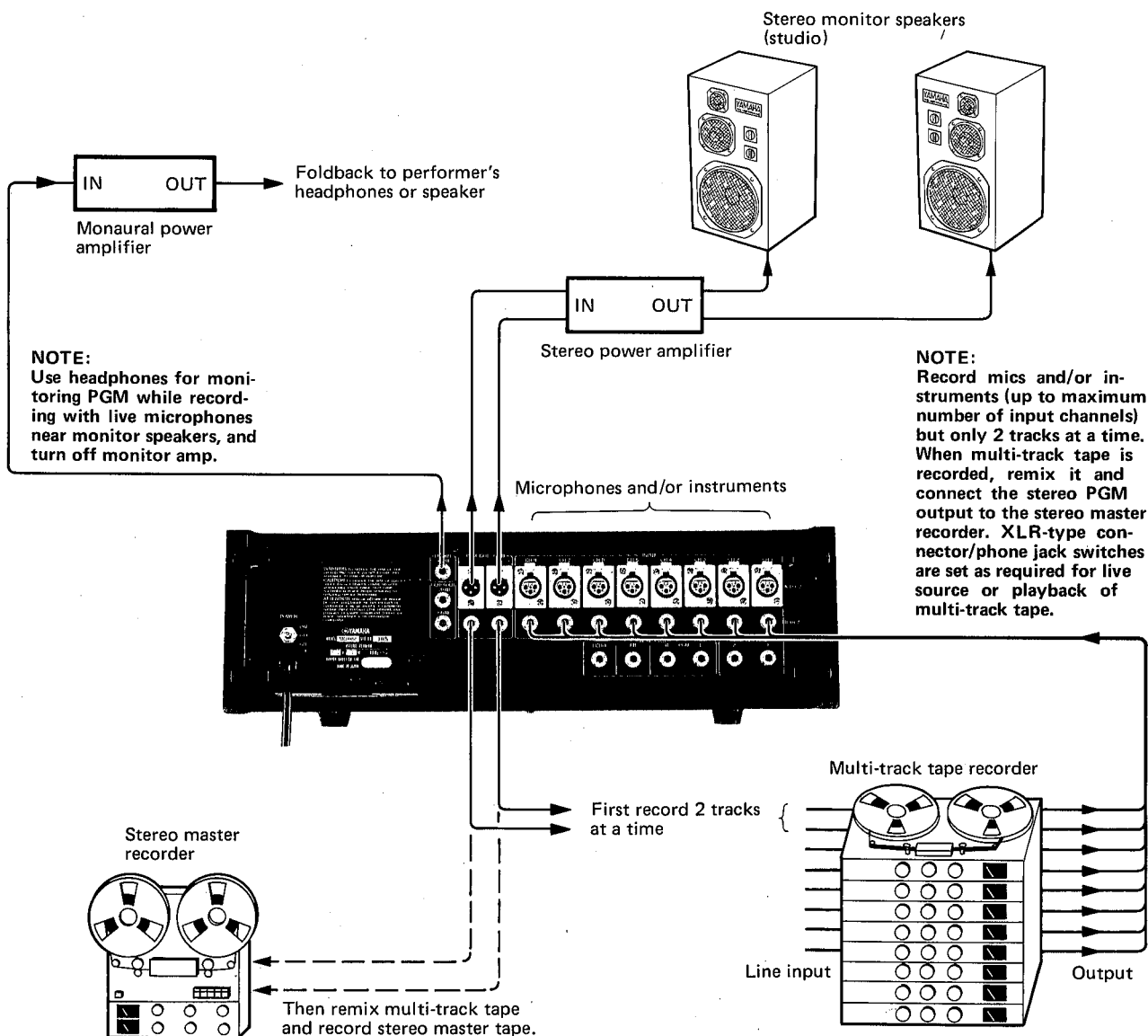

More About the Graphic Equalizers

Each slider is detented so it "clicks" at the center ("flat") point of its boost/cut range. These equalizers provide far more flexibility than typical tone controls. Acoustic feedback can be reduced by lowering the slider which covers the frequency range where the feedback occurs. Feedback frequencies can be estimated by comparing them to notes on a piano or other instrument ("middle C" is 256Hz, one octave above is approximately 512Hz, etc.).

Feedback control is actually a minor application for the Graphic Equalizers. Judicious use of the Equalizers can help the PA system sound more natural in troublesome acoustic environments, and can add desired color, warmth or penetration even in good acoustic environments. For example, some clubs have large amounts of sound-absorbing carpeting, drapery, furniture, etc. Since absorptive materials affect mostly the high-frequencies, the sound may be too mellow or

bassy. Other rooms with very hard walls and ceilings, or hard surfaced dance floors, may sound too bright. Or perhaps the speaker system is deficient in one frequency band yet is peaky in another band. Adjusting the Graphic Equalizer can compensate partially for these problems in a way that would be difficult to achieve with input channel EQ controls.

The Graphic Equalizers may also be used for many special effects. As with any equalizer, greater amounts of boost or cut cause greater phase shift. Therefore, use graphic equalization sparingly; extreme settings should be reserved for solving severe problems or for special effects. To keep distortion at a minimum, avoid excessive boost at a single frequency. Since removing feedback frequencies with the Graphic Equalizers can also remove portions of desirable program material, you should first attempt to solve feedback problems by careful speaker and microphone placement.

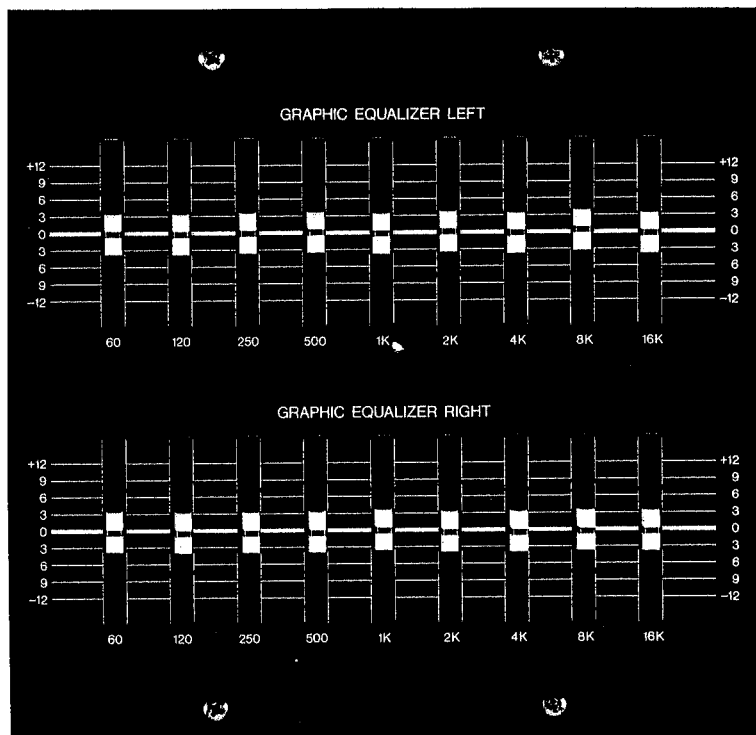

GENERAL SPECIFICATIONS

(Applies to all models, except as noted)

FREQUENCY RESPONSE (Channel In to PGM Out, 600Ω lines, +4dB nominal level)	+1, -3dB; 20Hz to 20kHz +0, -0.5dB; 70Hz to 10kHz.	
TOTAL HARMONIC DISTORTION (THD)* (Channel In to PGM Out, 600Ω lines)	Less than 0.5%, +4dB**, 20Hz to 20kHz; Less than 0.2%, +14dB, 70Hz to 15kHz;	
HUM AND NOISE* (20Hz to 20kHz, with 150Ω source Input Level switch set at "-60")	INPUT A (XLR INPUT) -126dBm Equivalent Input Noise (EIN); INPUT B (-122dBm Equivalent Input Noise (EIN); -94dB residual output noise with all Faders down.	
(")	-65dB PROGRAM OUT; Master Fader at nominal level & all Input Faders down.***	
(")	-62dB PROGRAM OUT (66dB S/N); Master Fader and one Input Fader at nominal level.***	
(")	-62dB FB or ECHO OUT (66dB S/N); Master Fader and one FB or ECHO mix control at nominal level.***	
MAXIMUM VOLTAGE GAIN (Input Level Switches set at "-60"dB, where applicable)	PGM	76dB; Channel In to PGM Out.
	FB	76dB; Channel In to FB Out.
	ECHO	82dB; Channel In to ECHO +4 Out. 58dB; Channel In to ECHO -20 Out.
	AUX IN	36dB; Aux In to PGM Out.
	SUB IN	6dB; Sub In to PGM, FB, or ECHO +4 Out.
MAXIMUM OUTPUT LEVEL	+18dB, @1% T.H.D., PGM, FB & ECHO Out.	
CROSSTALK	-60dB, @1kHz; adjacent inputs, or input to PGM, FB or ECHO output.	
INPUT CHANNEL EQUALIZATION	LOW	± 15dB at 100Hz, shelving.
	LOW-MID	± 15dB at 500Hz, peaking.
	HI-MID	± 15dB at 3kHz, peaking.
	HIGH	± 15dB at 10kHz, shelving.
PROGRAM L & R OUTPUT GRAPHIC EQUALIZATION	9 bands (X2, L+R), ± 12dB at 60, 120, 250, 500, 1k, 2k, 4k, 8k & 16kHz.	
PEAK LEVEL METERS	Fluorescent bar graph peak level meters; upper bar switchable for PGM L or FB, lower bar switch- able for PGM R or ECHO. "0"dB display = +4dB at mixer output..	
PEAK INDICATORS	1 LED built into each input channel turns on RED when the signal after the input level selec- tor reaches or exceeds 3dB below clipping.	
FINISH	Black painted front panels with gold lettering, rosewood veneer cabinet, color coded knobs.	
DIMENSIONS: (W x D x H)	MQ802	528 x 546 x 171mm (20-7/8 x 21-1/2 x 6-3/4")
	MQ1202	668 x 546 x 171mm (26-5/16 x 21-1/2 x 6-3/4")
	MQ1602	808 x 546 x 171mm (31-3/4 x 21-1/2 x 6-3/4")
NET WEIGHT	MQ802	13kg (28.6 lbs)
	MQ1202	16kg (35.2 lbs)
	MQ1602	19kg (41.8 lbs)
POWER SUPPLY	Self-contained module inside the console, fused and fully regulated.	
AC MAINS REQUIRE- MENTS: (MQ802, MQ1202 & MQ1602)	100/120/220/240V (± 10%) 50 or 60Hz	
POWER CONSUMPTION	MQ802	24W
	MQ1202	27W
	MQ1602	30W

* Measured with a 6dB/octave filter @12.47kHz; equivalent to a 20kHz filter with infinite dB/octave attenuation.

** In these specifications, 0dB is referenced to 0.775V RMS (0dBm at 600Ω).

*** Nominal level is 6dB below maximum setting.

INPUT/OUTPUT SPECIFICATIONS, EQUALIZER CHARACTERISTICS

INPUT SPECIFICATIONS

CONNECTION	INPUT LEVEL SWITCH	ACTUAL LOAD IMPEDANCE	FOR USE WITH NOMINAL	SENSITIVITY** (at MAX. GAIN)	INPUT LEVEL		CONNECTOR***	
					NOMINAL	MAX. before CLIP		
INPUTS MQ802 CH1 ~ 8 MQ1202 CH1 ~ 12 MQ1602 CH1 ~ 16	A (Lo-Z)	-60dB*	800Ω	50 ~ 250Ω microphones or 600Ω line level sources	-72dB (0.19mV)	-60dB (0.78mV)	-30dB (24.5mV)	XLR-3-31 type {MQ1602 General Model XLR-3-31 type + Multi Connector (FK-37-32S)}
		-50dB	800Ω		-62dB (0.62mV)	-50dB (2.5mV)	-20dB (78mV)	
		-35dB	800Ω		-47dB (3.5mV)	-35dB (13.8mV)	-5dB (436mV)	
		-20dB	1.2kΩ		-32dB (19.5mV)	-20dB (78mV)	+10dB (2.45V)	
		-10dB	2.3kΩ		-22dB (61.5mV)	-10dB (245mV)	+20dB (7.75V)	
		+4dB	2.6kΩ		-8dB (309mV)	+4dB (1.23V)	+24dB (12.3V)	
	B (Hi-Z)	-60dB	25kΩ	50 ~ 50kΩ microphones or 600Ω line level sources	-72dB (0.19mV)	-60dB (0.78mV)	-30dB (24.5mV)	Phone jack
		-50dB	25kΩ		-62dB (0.52mV)	-50dB (2.5mV)	-20dB (78mV)	
		-35dB	25kΩ		-47dB (3.5mV)	-35dB (13.8mV)	-5dB (436mV)	
		-20dB	27kΩ		-32dB (19.5mV)	-20dB (78mV)	+10dB (2.45V)	
		-10dB	49kΩ		-22dB (61.5mV)	-10dB (245mV)	+20dB (7.75V)	
		+4dB	54kΩ		-8dB (309mV)	+4dB (1.23V)	+24dB (12.3V)	
	AUX IN (1, 2)		25kΩ	600Ω lines	-32dB (19.5mV)	-20dB (78mV)	+24dB (12.3V)	Phone jack
	SUB IN PGM (L, R) FB, ECHO		1kΩ	600Ω lines	-2dB (616mV)	+4dB (1.23V)	+24dB (12.3V)	Phone jack

OUTPUT SPECIFICATIONS

CONNECTOR	ACTUAL SOURCE IMPEDANCE	FOR USE WITH NOMINAL	OUTPUT LEVEL		CONNECTOR***
			NOMINAL	MAX. before CLIP	
PGM. OUT (L, R)	130Ω	600Ω lines	+4dB (1.23V)	+18dB (6.2V)	XLR 3-32 type & Phone jack
FB OUT ECHO OUT (+4) ECHO OUT (-20)	130Ω	600Ω lines	+4dB (1.23V) +4dB (1.23V) -20dB (78mV)	+18dB (6.2V) +18dB (6.2V) -6dB (388mV)	Phone jack
PHONES	33Ω	8Ω phones	-6dB (388mV)	+2dB (976mV)	STEREO phone jack

* 0dB is referenced to 0.775V RMS.

** Sensitivity is the lowest level that will produce an output of +4dB (1.23V), or the nominal input level when the unit is set to maximum gain.

*** All XLR-type connectors are floating ("balanced") and transformer-isolated. Phone jacks are unbalanced. (TRS)

All specifications subject to change without notice or obligation.

EQUALIZER CHARACTERISTICS

Input channel

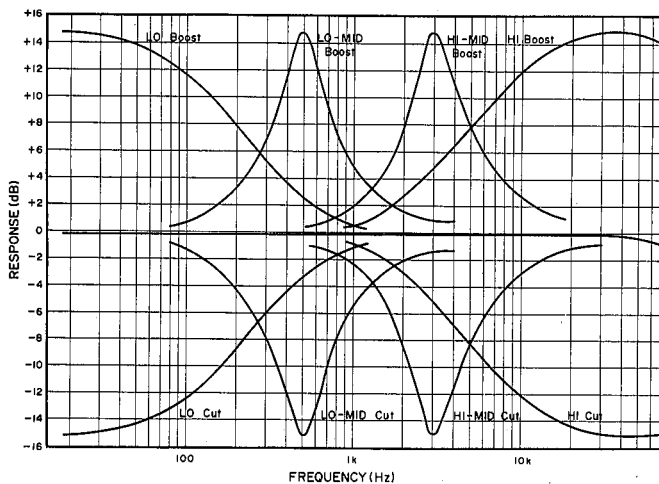

Graphic

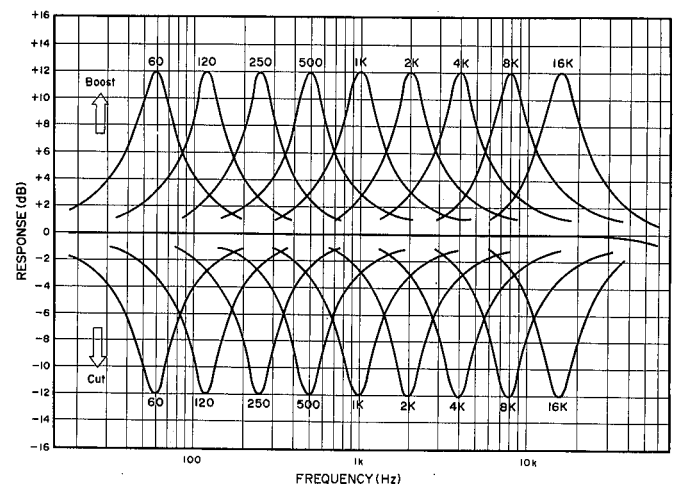

LEVEL DIAGRAM

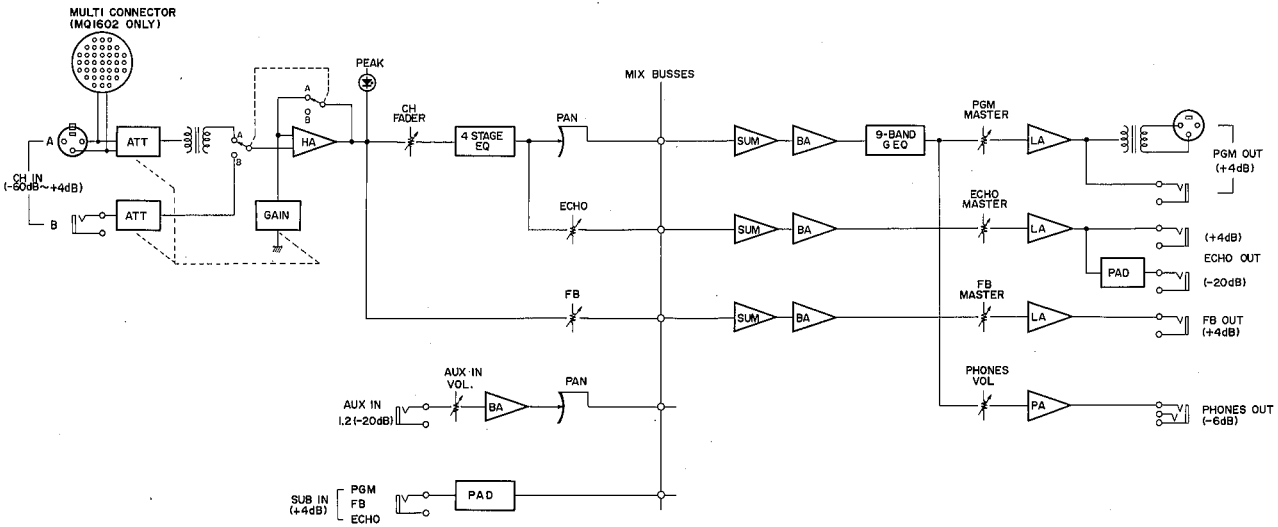
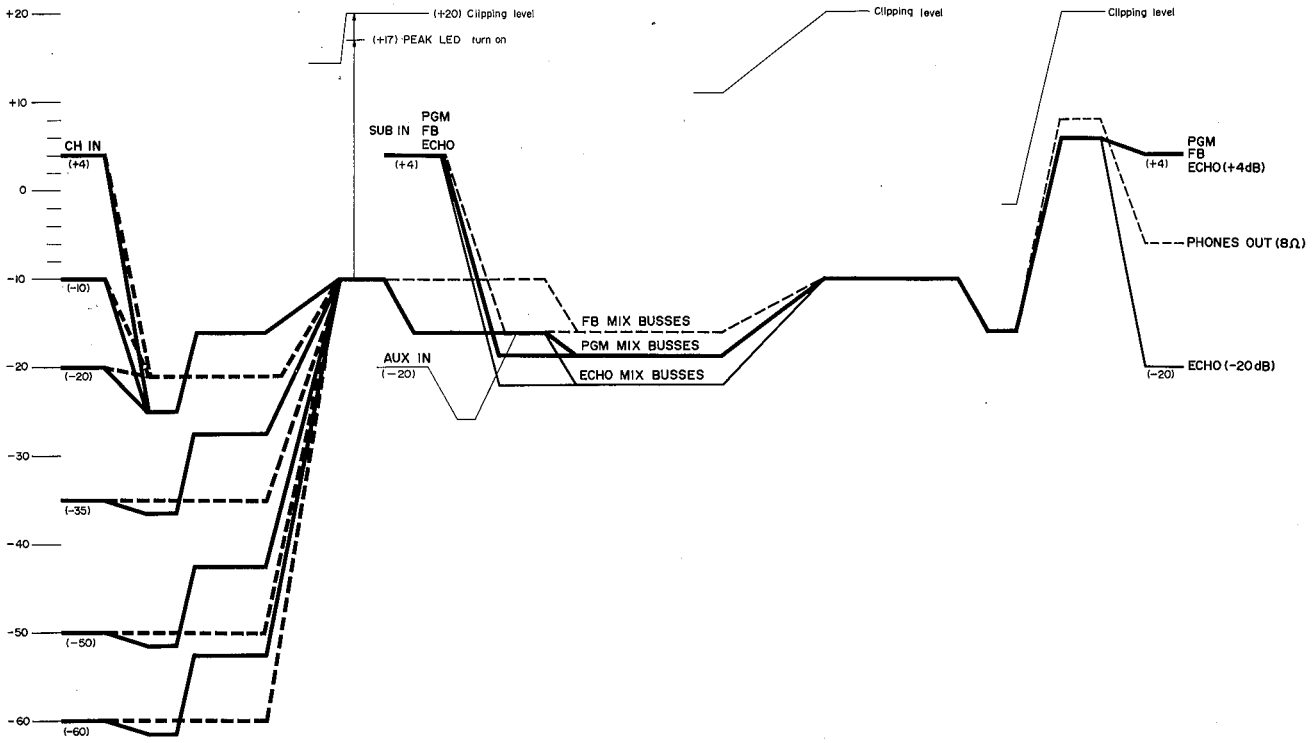

HOW TO CONNECT MULTI-CONNECTOR (ACCESSORY) & CABLE

MQ1602 general model is provided with a multi-connector as an accessory.

Connect the multi-connector and the cable referring to the following figure and steps of procedure.

1. Put the cable through the end bell. If the clamp is found loose, use a sleeve.
2. Strip the cover off the wire 6 ~ 8mm from its end and solder it to the contact. Solder is already provided in the hole of the contact to facilitate the work which must be carried out within a short time not to allow extra flux or solder to flow out of the hole.
3. Fit the end bell on to the contact and secure it with four screws.
4. Fix the cable by tightening the clamp screw.

Pin connection

MULTI CONNECTOR PIN NO.	CH NO.	XLR PIN NO.	MULTI CONNECTOR PIN NO.	CH NO.	XLR PIN NO.
1	CH1	2	20	COMMON SHIELD	
2	CH1	3	21	CH9	2
3	CH2	2	22	CH9	3
4	CH2	3	23	CH10	2
5	CH3	2	24	CH10	3
6	CH3	3	25	CH11	2
7			26	CH11	3
8	CH4	2	27	CH12	2
9	CH4	3	28	CH12	3
10	CH5	2	29	CH13	2
11	CH5	3	30	CH13	3
12	CH6	2	31		
13	CH6	3	32	CH14	2
14	CH7	2	33	CH14	3
15	CH7	3	34	CH15	2
16	CH8	2	35	CH15	3
17	CH8	3	36	CH16	2
18	COMMON SHIELD		37	CH16	3
19	COMMON SHIELD				

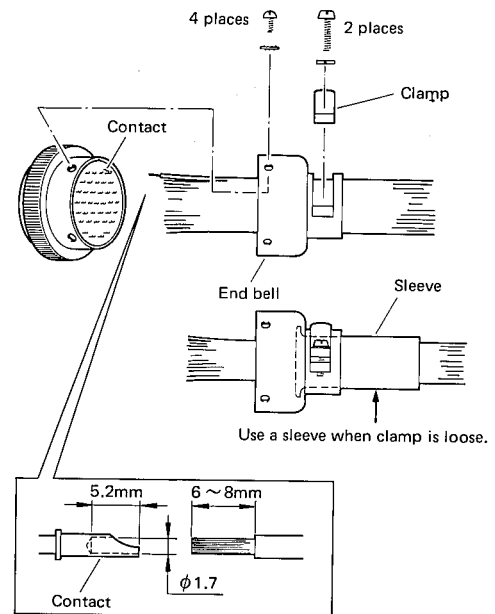

Multi-connector (MQ1602 only)

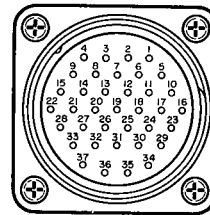

MAINTENANCE & SERVICE

Panel and Cabinet Cleaning

The black panels should be cleaned with a damp sponge. Stubborn soil can be removed with a mild detergent solution, such as dishwashing detergent. Strong detergents and chemical solvents may damage the plastic fittings.

The wood veneer cabinet will retain its beautiful finish with very little care. When it looks dull or soiled, apply any liquid or paste furniture polish and buff with a soft cloth; aerosols should be avoided because the solvents may damage adjacent portions of the mixer, especially the meter face.

Inside the Mixer

WARNING: There are no user-serviceable parts inside the mixer. Only qualified service personnel should attempt to open the unit for any purpose. Lethal voltages are present inside the mixer, and the AC line cord should be DISCONNECTED PRIOR TO OPENING IT.

To qualified service personnel: Each input channel's components are mounted on a separate printed circuit board with metal shielded enclosure. This module can be removed for repair or exchange in 4 easy steps: (a) pull off the control knobs and unscrew the nuts on 2 control shafts, (b) remove the mixer's bottom cover and stand the mixer on its back edge, (c) unplug the ribbon cable from the channel module, and (d) swing the module away from the chassis and remove it. This modular design allows the mixer to be operated normally while a channel has been removed for repair. The MQ's graphic equalizers and output circuits are similarly arranged on quick-change modules. As a further convenience, the hinged power supply chassis swings down onto the work bench so the mixer remains operable without using special jumper cables.

SERVICE

The IMQ mixers are supported by a worldwide network of factory trained and qualified dealer service personnel. In the event of a problem, contact your nearest IMQ mixer dealer, or distributor.

YAMAHA 1602
MULTI-PURPOSE COPY MACHINE

