

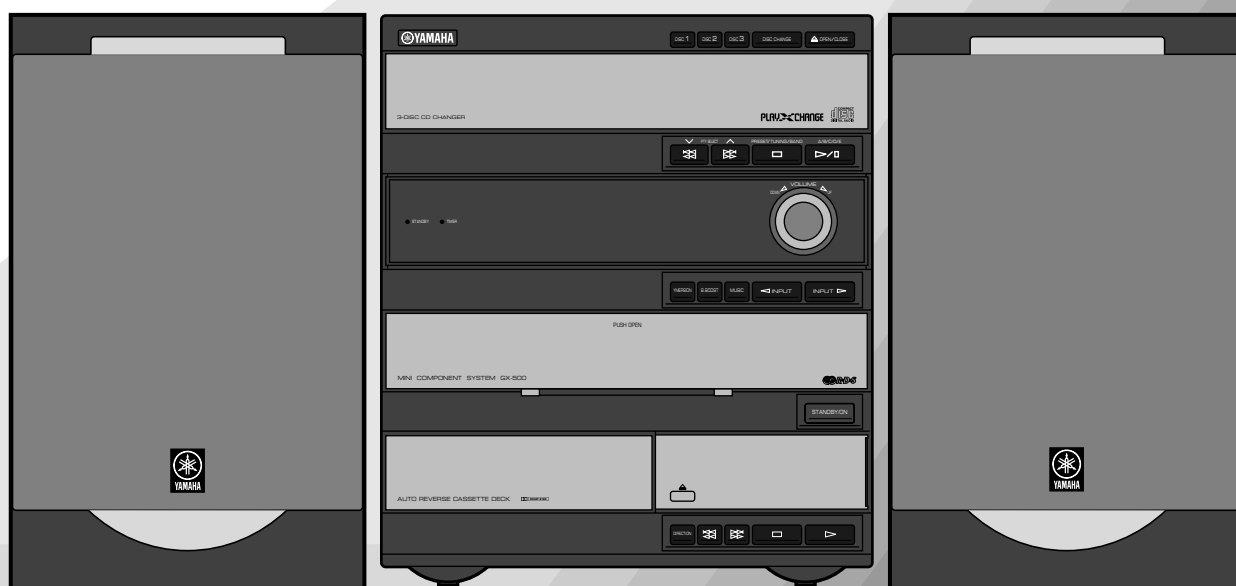

# GX-500

*MINI COMPONENT SYSTEM  
CHAÎNE COMPACTE*



**OWNER'S MANUAL  
MODE D'EMPLOI  
BEDIENUNGSANLEITUNG  
BRUKSANVISNING  
MANUALE DI ISTRUZIONI  
MANUAL DE INSTRUCCIONES  
GEBRUIKSAANWIJZING**

**Unpacking**  
**Déballage**  
**Auspacken**  
**Uppackning**  
**Disimballaggio**  
**Desembalaje**  
**Uitpakken**

- After unpacking, check that the following parts are contained.
- Après le déballage, vérifiez que les pièces suivantes sont incluses.
- Nach dem Auspacken überprüfen, ob die folgenden Teile vorhanden sind.
- Kontrollera efter det apparaten packats upp att följande delar finns med.
- Verificare che tutte le parti seguenti siano contenute nell'imballaggio dell'apparecchio.
- Desembale el aparato y verifique que los siguientes accesorios están en la caja.
- Controleer na het uitpakken of de volgende onderdelen voorhanden zijn.

- Main unit
- Appareil principal
- Gerät
- Huvudapparat
- Apparecchio principale
- Aparato principal
- Hoofdeenheid

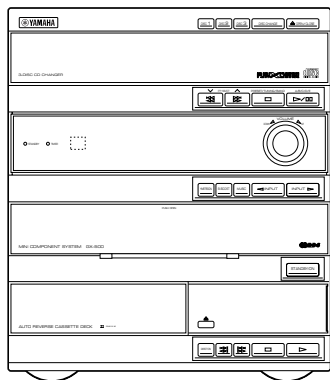

- Speakers
- Enceintes
- Lautsprecher
- Högtalare
- Altoparlanti
- Altavoces
- Luidsprekers

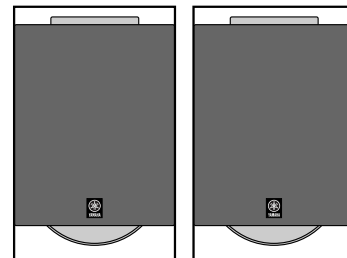

- Remote control
- Télécommande
- Fernbedienung
- Fjärrkontroll
- Telecomando
- Control remoto
- Afstandbediening

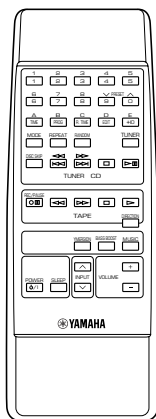

- Speaker cords
- Câbles d'enceintes
- Lautsprecherkabel
- Högtalarledning
- Cavi per gli altoparlanti
- Cables de los altavoces
- Luidsprekerdraden

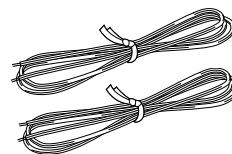

- AM loop antenna
- Antenne-cadre AM
- AM-Rahmenantenne
- AM ramantenn
- Antenna ad anello per AM
- Antena de cuadro AM
- AM lusantenne

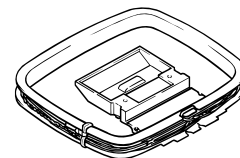

- Batteries (size AA, UM/SUM-3, R6, HP-7)
- Piles (format AA, UM/SUM-3, R6, HP-7)
- Batterien (Größe AA, UM/SUM-3, R6, HP-7)
- Batterier (Storl. AA, UM/SUM-3, R6, HP-7)
- Batterie (dimensioni AA, o UM/SUM-3, o R6, o HP-7)
- Pilas (tamaño AA, tipo UM/SUM-3, R6, HP-7)
- Batterijen (maat AA, UM/SUM-3, R6, HP-7)

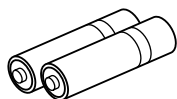

- Indoor FM antenna
- Antenne intérieure FM
- UKW-Innenantenne
- FM inomhusantenn
- Antenna FM per interni
- Antena interior de FM
- FM binnenantenne

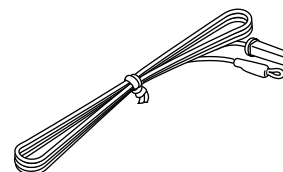

- Setting this system
- Installation de ce système
- Aufstellen des Systems
- Iordningsställande av denna anläggning
- Installazione del sistema
- Instalación del sistema
- Opstelling van dit systeem

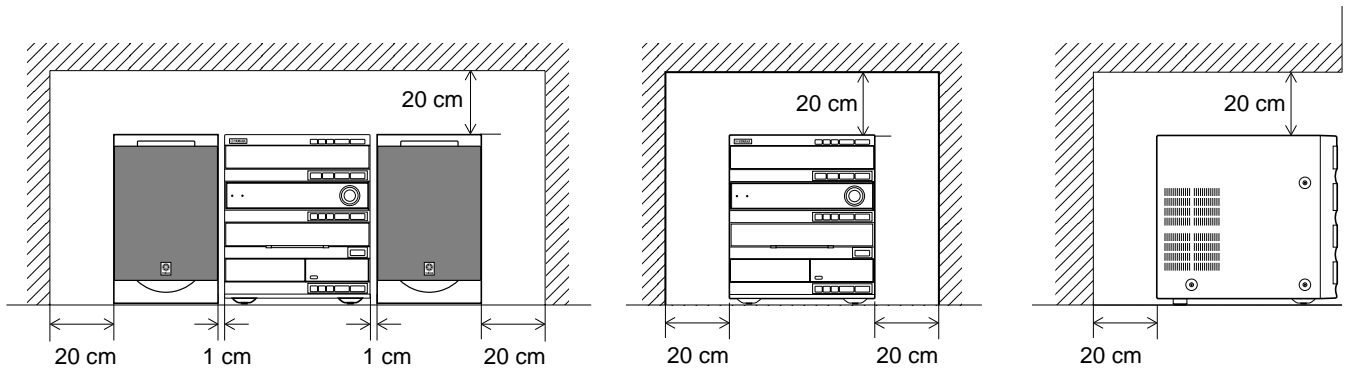

### English

Set this system allowing enough spaces around and behind the main unit to assure good ventilation. Be sure not to place another unit or any object on top of the main unit to prevent the ventilation holes from being obstructed. Otherwise, it may cause fire or damage to the main unit.

**Note:** When placing the speakers apart from the main unit, be sure to allow a space of at least 20 cm above, behind and on both sides of the main unit. If the main unit is put in a rack, the front of it must be fully opened.

### Français

Installer ce système en laissant assez d'espace autour et derrière l'appareil principal pour assurer une bonne ventilation. Veiller à ne pas empiler un autre appareil ou un autre objet sur l'appareil principal afin de ne pas boucher les orifices de ventilation. Sinon, on risquerait de provoquer un incendie ou d'endommager l'appareil principal.

**Remarque:** Lorsqu'on place les enceintes à une certaine distance de l'appareil principal, veiller à laisser un espace d'au moins 20 cm au-dessus, derrière et sur les deux côtés de l'appareil principal. Si l'on place l'appareil principal dans un meuble, veiller à ce que le côté avant du meuble soit grand ouvert.

### Deutsch

Stellen Sie das System so auf, daß um und hinter dem Gerät genügend freier Raum vorhanden ist, um eine ausreichende Belüftung zu gewährleisten. Es dürfen keine anderen Geräte oder Gegenstände auf das Gerät gestellt werden, weil die Belüftungsschlitze nicht abgedeckt werden dürfen. Bei abgedeckten Belüftungsöffnungen kann ein Brand verursacht werden oder das Gerät kann beschädigt werden.

**Hinweis:** Wenn die Lautsprecher vom Gerät entfernt aufgestellt werden, muß ein freier Abstand von mindestens 20 cm über, hinter und auf beiden Seiten des Gerätes vorhanden sein. Wenn das Gerät in einem Regal oder Schrank aufgestellt wird, so muß die Vorderseite vollständig geöffnet sein.

### Svenska

Vid placeringen av anläggningen, skall du se till att det finns tillräckligt med fritt utrymme runt om samt bakom huvudapparaten, för att tillförsäkra en bra ventilation. Var noga med att inte ställa någon annan apparat eller något föremål ovanpå huvudapparaten för att förhindra att ventilationshålen blir blockerade. Annars kan huvudapparaten utsättas för brand eller skadas på annat sätt.

**Anmärkning:** När högtalarna ställs separat från huvudapparaten, skall du förvissa dig om att det finns ett fritt utrymme på minst 20 cm ovanför, bakom och på huvudapparatens båda sidor. Om huvudapparaten placeras i en stereomöbel, måste möbelns framsida lämnas helt öppen.

### Italiano

Installare il sistema lasciando sufficiente spazio intorno e dietro all'apparecchio centrale per garantire una ventilazione sufficiente. Evitare assolutamente di posizionare altri dispositivi o oggetti sulla parte superiore dell'apparecchio centrale onde evitare di ostruirne le aperture per la ventilazione presenti. In caso contrario possono verificarsi incendi, o l'apparecchio può subire danni.

**Nota:** Se si installano gli altoparlanti lontano dall'apparecchio principale, quest'ultimo deve essere posizionato in modo da avere almeno 20 cm di spazio libero sopra, dietro e sui due lati. Se si installa l'apparecchio principale in uno scaffale, il lato anteriore dello scaffale deve essere completamente aperto.

### Español

Instale el sistema dejando suficiente espacio alrededor y detrás de la unidad principal para garantizar una buena circulación de aire. No instale otro aparato o un objeto encima de la unidad principal porque obstruirá los orificios de salida de aire. Puede provocar un fuego o dañar la unidad principal.

**Nota:** Cuando instale los altavoces alejados de la unidad principal, asegúrese de dejar un espacio de por lo menos 20 cm encima, detrás y a ambos lados de la unidad principal. Si se coloca la unidad principal dentro de un mueble, no debe cerrar la tapa delantera.

### Nederlands

Zorg ervoor bij de opstelling van dit systeem dat er voldoende ruimte rondom en aan de achterzijde van de hoofdeenheid is voor het verkrijgen van een goede ventilatie. Plaats geen andere apparatuur of voorwerpen bovenop de hoofdeenheid om te voorkomen dat de ventilatieopeningen geblokkeerd raken. Anders kan dit brandgevaar en beschadiging van de hoofdeenheid veroorzaken.

**Opmerking:** Bij het opstellen van de luidsprekers op afstand van de hoofdeenheid, een ruimte van tenminste 20 cm aan de bovenzijde, achterzijde en aan de linker en rechter zijde van de hoofdeenheid open laten. Als de hoofdeenheid in een rek wordt geplaatst, dient de voorzijde ervan volledig open te zijn.

● Front panel  
● Frampanelen  
● Voorpaneel

● Panneau avant  
● Pannelo anteriore

● Frontseite  
● Panel delantero

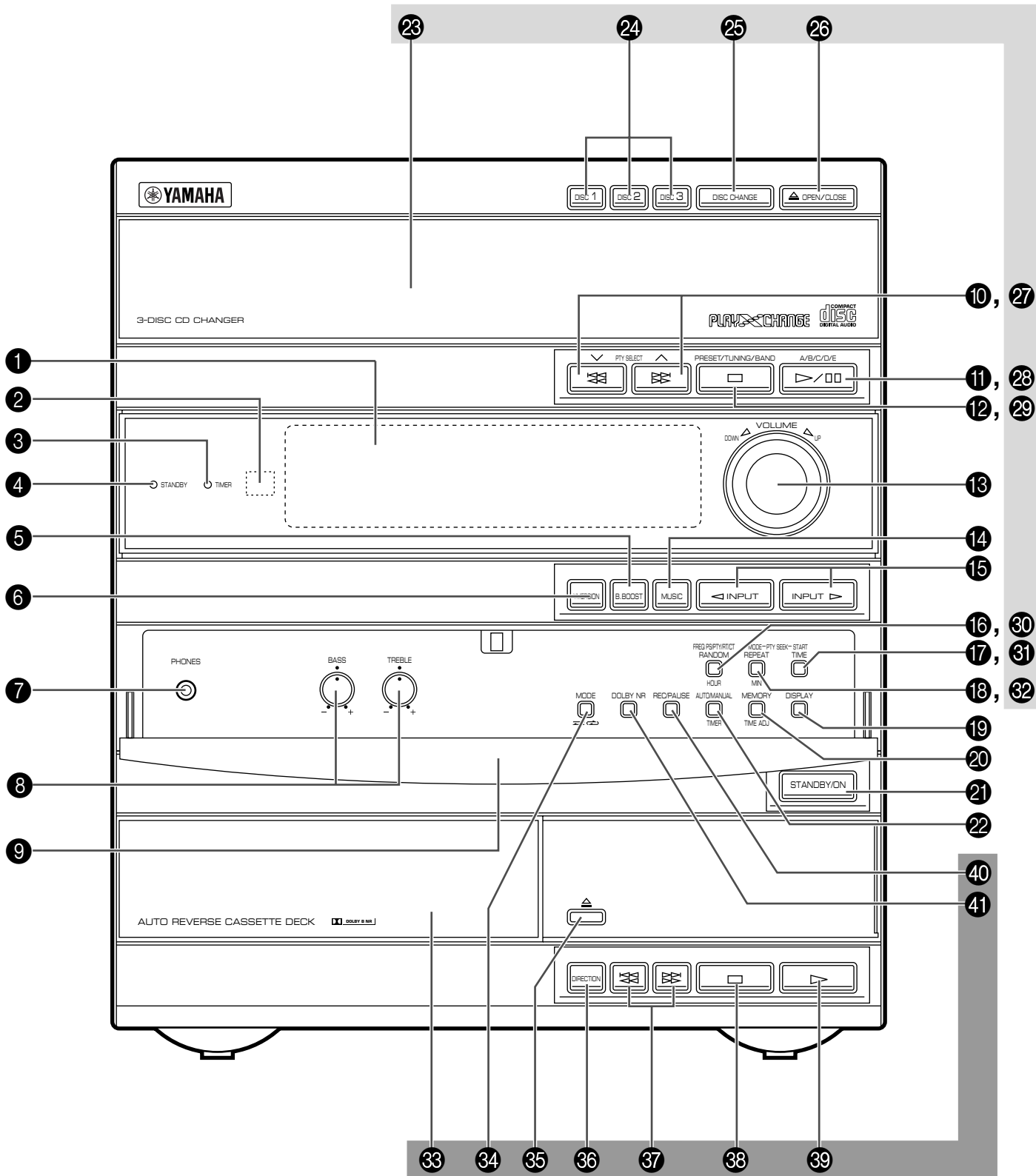

Amplifier/tuner Förstärkare/tuner Versterker/tuner	Amplificateur/tuner Amplificatore/sintonizzatore	Verstärker/Tuner Amplificador/sintonizador
--	---	---

- ① Display panel  
Panneau d'affichage  
Anzeigefeld  
Display  
Quadrante delle indicazioni  
Visualizador  
Displaypaneel
- ② Remote control sensor  
Capteur de télécommande  
Fernbedienungssensor  
Fjärrkontrollsensor  
Sensore del telecomando  
Sensor del control remoto  
Afstandbedieningsensor
- ③ TIMER
- ④ STANDBY [p. 9]
- ⑤ B. BOOST [p. 32]

- ⑥ YMERSION [p. 32]
- ⑦ PHONES [p. 32]
- ⑧ BASS/TREBLE [p. 32]
- ⑨ Front cover  
Couvercle avant  
Reglerfachabdeckung  
Frontluckan  
Sportello anteriore  
Cubierta delantera  
Voorklepje
- ⑩ ^/∨ [p. 15, 16]  
PTY SELECT [p. 20]
- ⑪ A/B/C/D/E [p. 16]
- ⑫ PRESET/TUNING/BAND  
[p. 15]

- ⑬ VOLUME [p. 31]
- ⑭ MUSIC [p. 31]
- ⑮ INPUT (</>) [p. 9, 15, 23, 30]  
TUNER → TAPE → CD → AUX/MD  
↑
- ⑯ FREQ PS/PTY/RT/CT [p. 18]  
HOUR [p. 7, 33]
- ⑰ PTY SEEK START [p. 20]
- ⑱ PTY SEEK MODE [p. 7, 9]  
MIN [p. 7, 33]
- ⑲ DISPLAY [p. 7, 33]
- ⑳ MEMORY [p. 16, 17]  
TIME ADJ [p. 7]
- ㉑ STANDBY/ON [p. 9]
- ㉒ AUTO/MANUAL [p. 15]  
TIMER [p. 33]

CD player CD-spelare Compact disc speler	Lecteur de disque compact Lettore CD	CD-Spieler Tocadiscos de discos compactos
--	---	--

- ⑳ Disc tray  
Plateau de disque  
CD-Lade  
Skivfack  
Piatto portadischi  
Plato del disco  
Disc-lade  
[p. 9]

- ㉔ DISC (1, 2, 3) [p. 10]
- ㉕ DISC CHANGE [p. 10]
- ㉖ OPEN/CLOSE [p. 9]
- ㉗ <<< (<<<)/>>> (>>>) [p. 10]
- ㉘ >/∞ [p. 9]

- ㉙ □ [p. 9]
- ㉚ RANDOM [p. 12]
- ㉛ TIME [p. 13]
- ㉜ REPEAT [p. 12]

Tape deck Kassettdäck Tapedeck	Platine cassette Registratore	Kassetendeck Platina
--------------------------------------	----------------------------------	-------------------------

- ㉛ Tray  
Plateau  
Cassettenlade  
Kassettfack  
Vano portacassette  
Bandeja  
Lade  
[p. 23]

- ㉜ MODE [p. 23]
- ㉝ △ [p. 23]
- ㉞ DIRECTION [p. 23]
- ㉟ <<< (<<<)/>>> (>>>) [p. 24]

- ㉜ □ [p. 23]
- ㉝ ▷ [p. 23]
- ㉞ REC/PAUSE [p. 25]
- ㉟ DOLBY NR [p. 22, 25]

- Remote control
- Fjärrkontrollen
- Afstandbediening

- Telecommande
- Telecomando

- Fernbedienung
- Control remoto

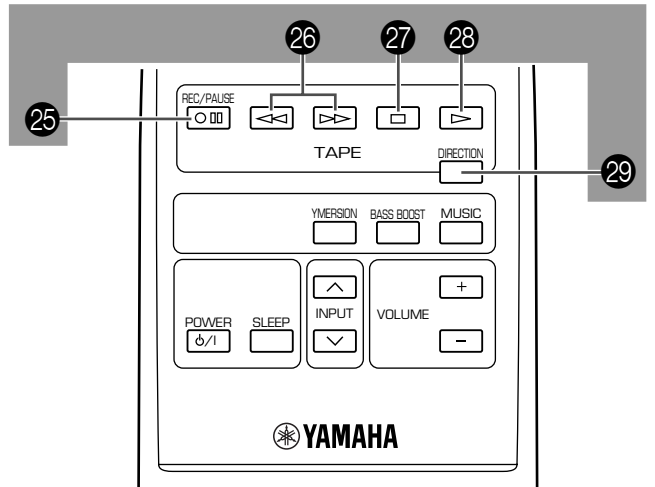
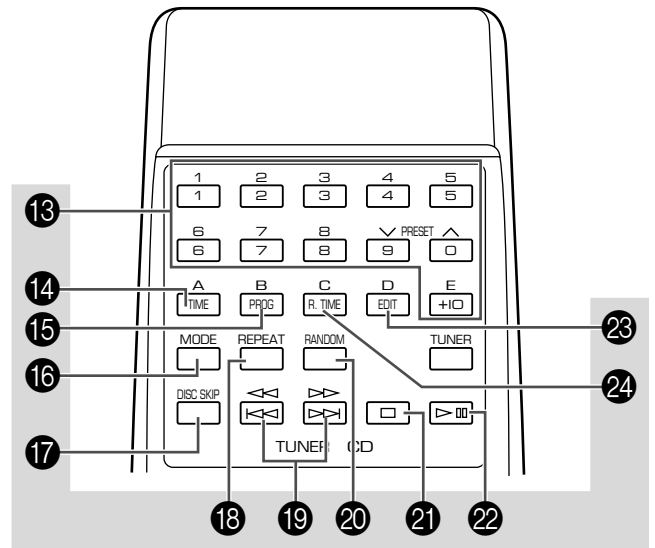
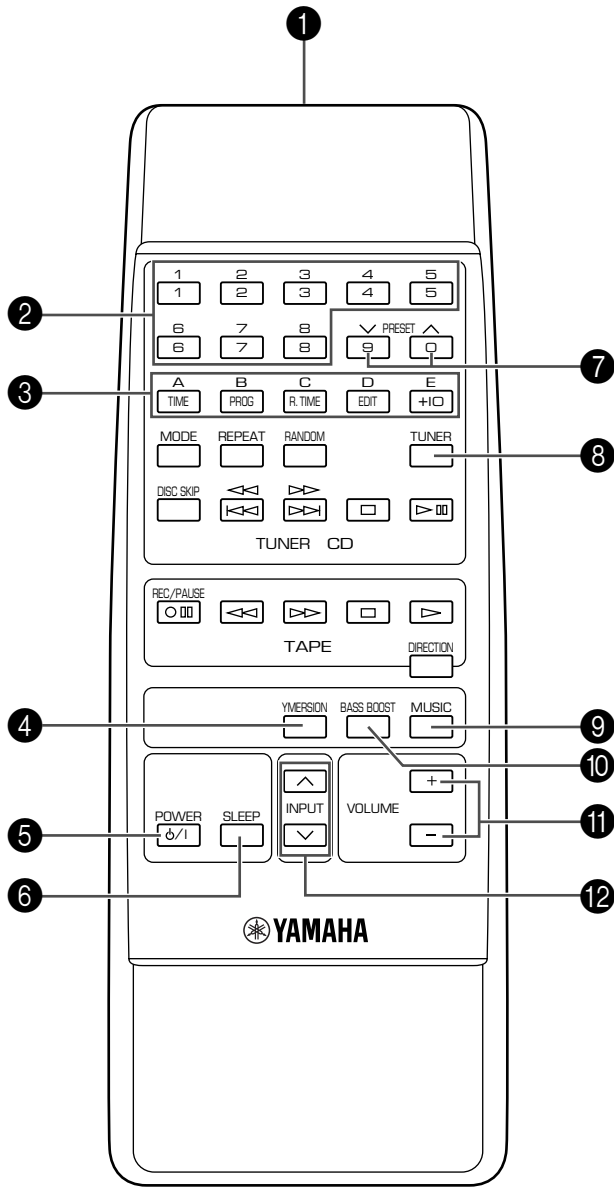

Amplifier/tuner Förstärkare/tuner Versterker/tuner	Amplificateur/tuner Amplificatore/sintonizzatore	Verstärker/Tuner Amplificador/sintonizador
--	---	---

- |  |  |  |
|--|--|--|
| <p>① Transmission window<br/>Fenêtre de transmission<br/>Übertragungsfenster<br/>Fjärrkontrollsändare<br/>Apertura di emissione dei raggi infrarossi<br/>Ventanilla de transmisión<br/>Signaalvenster<br/>[p. 4]</p> <p>② Numeric buttons<br/>Touches numériques<br/>Zahlentasten<br/>Sifferknappar<br/>Tasti numerici<br/>Botones numéricos<br/>Cijfertoetsen<br/>[p. 16]</p> | <p>③ A, B, C, D, E [p. 16]</p> <p>④ YMERSION [p. 32]</p> <p>⑤ POWER [p. 9]</p> <p>⑥ SLEEP [p. 34]</p> <p>⑦ PRESET ( ^ / v )<br/>[p. 16]</p> <p>⑧ TUNER [p. 15]</p> | <p>⑨ MUSIC [p. 31]</p> <p>⑩ BASS BOOST<br/>[p. 32]</p> <p>⑪ VOLUME (+/-)<br/>[p. 31]</p> <p>⑫ INPUT ( ^ / v )<br/>[p. 9, 15, 23, 30]</p> <p style="text-align: center;">TUNER → TAPE<br/>↑ ↓<br/>AUX/MD ← CD</p> |
|--|--|--|

CD player CD-spelare Compact disc speler	Lecteur de disque compact Lettore CD	CD-Spieler Tocadiscos de discos compactos
--	---	--

- |   |  |  |
|---|--|--|
| <p>⑬ Numeric buttons<br/>Touches numériques<br/>Zahlentasten<br/>Sifferknappar<br/>Tasti numerici<br/>Botones numéricos<br/>Cijfertoetsen<br/>[p. 10]</p> <p>⑭ TIME [p. 13]</p> | <p>⑮ PROG [p. 11]</p> <p>⑯ MODE [p. 9]</p> <p>⑰ DISC SKIP [p. 10]</p> <p>⑱ REPEAT [p. 12]</p> <p>⑲ &lt;&lt;&lt; ( &lt;&lt;&lt; ) / &gt;&gt;&gt; ( &gt;&gt;&gt; ) [p. 10]</p> | <p>⑳ RANDOM [p. 12]</p> <p>㉑ □ [p. 9]</p> <p>㉒ ▷ ■ [p. 9]</p> <p>㉓ EDIT [p. 27]</p> <p>㉔ R. TIME [p. 27]</p> |
|---|--|--|

Tape deck Kassettdäck Tapedeck	Platine cassette registratore	Kassettdeck Platina
--------------------------------------	----------------------------------	------------------------

- |   |                                       |                            |
|---|---------------------------------------|----------------------------|
| <p>⑳ REC/PAUSE [p. 25]</p> <p>㉑ &lt;&lt;&lt;/&gt;&gt;&gt; [p. 24]</p> | <p>㉒ □ [p. 23]</p> <p>㉓ ▷ [p. 23]</p> | <p>㉔ DIRECTION [p. 23]</p> |
|---|---------------------------------------|----------------------------|

# English

Thank you for purchasing this YAMAHA product. We hope it will give you many years of trouble-free enjoyment.  
For the best performance, read this manual carefully. It will guide you in operating your YAMAHA product.

## Contents

	Page		Page
<b>Precautions</b> .....	<b>1</b>	<b>Playing back a tape</b> .....	<b>22</b>
<b>Features</b> .....	<b>3</b>	General information .....	22
<b>Preparations and connections</b> .....	<b>4</b>	Basic operation .....	23
Installing batteries in the remote control .....	4	Winding the tape .....	24
Remote control operation range .....	4	Searching for the beginning of the desired selection .....	24
Connections .....	5	<b>Recording</b> .....	<b>25</b>
Setting the clock .....	7	Basic recording .....	25
Adjusting brightness of the display .....	7	Recording from CDs utilizing the EDIT function .....	27
<b>Compact disc player operation</b> .....	<b>8</b>	<b>Operating the external unit connected with this system</b> .....	<b>30</b>
Basic play .....	9	<b>Various sound control</b> .....	<b>31</b>
To change the disc play mode .....	9	<b>Using the built-in timer</b> .....	<b>33</b>
To select another disc .....	10	Timer play .....	33
To select the desired track directly .....	10	Timer recording .....	34
To play the desired track (Skip) .....	10	Sleep timer operation .....	34
To advance or reverse play rapidly (Search) .....	10	<b>Appendix</b> .....	<b>35</b>
To exchange a disc (or discs) while playing (PLAYXCHANGE) .....	10	Troubleshooting .....	35
Program play .....	11	Specifications .....	37
Random play .....	12		
Repeat play .....	12		
Switching the time display .....	13		
<b>Tuning operation</b> .....	<b>14</b>		
Automatic tuning .....	15		
Manual tuning .....	15		
Manual preset tuning .....	16		
Automatic preset tuning .....	17		
Receiving RDS stations .....	18		

For basic source play, the following illustrations on top of pages will help you to look for the section you need.



.....CD play



.....Tuning



.....Tape playback/recording



# Precautions: Read this before operating your system

- To assure the finest performance, please read this manual carefully. Keep it in a safe place for future reference.
- Choose the installation location of this system carefully. Avoid placing it in direct sunlight or close to a source of heat. Also avoid locations subject to vibration and excessive dust, heat, cold or moisture. Keep it away from sources of hum such as transformers and electric motors.
- Do not operate this system upside-down. It may overheat, possibly causing damage.
- Never open the cabinet. If something drops into the set, contact your dealer.
- The openings on the main unit cover assure proper ventilation of the main unit. If these openings are obstructed, the temperature inside the unit will rise rapidly. Therefore, avoid placing objects against these openings, and install the main unit in a well-ventilated area to prevent fire and damage.
- Always set the VOLUME control to minimum before starting an audio source play: increase the volume gradually to an appropriate level after play has started.
- When not planning to use this system for long periods of time (ie., vacation, etc.), disconnect the AC power plug from the wall outlet.
- Grounding or polarization – Precautions should be taken so that the grounding or polarization of this system is not defeated.
- Do not use force on switches, controls or connection wires. When moving the main unit, first disconnect the power plug and the wires connected to other equipment. Never pull the wire itself.
- If an external appliance (TV, radio, etc.) interferes with this system operation, move the main unit away from such an appliance.
- Do not attempt to clean this system with chemical solvents; this might damage the finish. Use a clean, dry cloth.
- Be sure to read the “Troubleshooting” section regarding common operating errors before concluding that this system is faulty.
- To prevent lightning damage, disconnect the AC power plug and the antenna cable when there is an electrical storm.
- Do not plug the AC power plug to the wall socket before you finish all connections.
- Never allow metallic items (e.g. screwdrivers, tools, etc.) to come near the tape deck’s record/playback head assembly. Doing so may not only scratch or damage the head’s mirror-smooth finish, it may change the magnetic characteristics of the heads, causing a deterioration in reproduction performance quality.
- Although the tape deck’s record/playback heads are high quality heads with outstanding reproduction characteristics, they can become dirty through the use of old tapes or from dust accumulation over time. This can have a serious effect on reproduction quality. Clean the heads regularly with one of the commonly available head cleaners or with cleaning solutions.
- The voltage to be used must be the same as that specified on this system. Using this system with a higher voltage than specified is dangerous and may result in a fire or other types of accidents causing damage. YAMAHA will not be held responsible for any damage resulting from use of this system with a voltage other than specified.
- The sound level at a given volume setting depends on speaker location and other factors. Care should be taken to avoid exposure to sudden high levels of sound, which may occur when turning on this system with the volume control setting at high, and to continuous high levels of sound.
- Sudden temperature changes and storage or operation in an extremely humid environment may cause condensation inside the cabinet. Condensation can cause this system to malfunction.

To eliminate condensation:

  - **CD pickup**  
Leave the power on with no disc loaded until normal play becomes possible (about 1 hour).
  - **Tape head**  
Leave the power on with no tape loaded until normal playback becomes possible (about 1 hour).  
**Note**  
If condensation forms on the tape head, dirt or dust may accumulate during use.
  - **Remote control**  
Wipe off condensation on the transmission window with a soft cloth before operating this system.
- To prevent a malfunction of this system:
  - Do not use any non standard shaped disc (heart etc.) available on the market, because it may damage this system.
  - Do not use a disc with tape, seals, or paste on it, because damage to this system may result.

This system is not disconnected from the AC power source as long as it is connected to the wall outlet, even if this system itself is turned off. This state is called the standby mode. In this state, this system is designed to consume a certain level of power.

**Note**  
Please check the copyright laws in your country to record from records, compact discs, radio, etc. Recording of copyright material may infringe copyright laws.

## Precautions: Read this before operating your system

### CAUTION FOR CARRYING THE MAIN UNIT

Be sure not to carry or tip the main unit with discs remaining in it.

### CAUTION FOR MOVING THE MAIN UNIT

Before moving the main unit, first remove all discs from the disc tray and close the tray by pressing the **OPEN/CLOSE** button. After you confirm that "NO DISC" lights up on the display, turn this system into the standby mode by pressing the **STANDBY/ON** switch, and then disconnect the power plug from the AC outlet.

### For U.K. customers

If the socket outlets in the home are not suitable for the plug supplied with this appliance, it should be cut off and an appropriate 3 pin plug fitted. For details, refer to the instructions described below.

**Note:** The plug severed from the mains lead must be destroyed, as a plug with bared flexible cord is hazardous if engaged in a live socket outlet.

### SPECIAL INSTRUCTIONS FOR U.K. MODEL

#### IMPORTANT:

THE WIRES IN MAINS LEAD ARE COLOURED IN ACCORDANCE WITH THE FOLLOWING CODE:

Blue: NEUTRAL  
Brown: LIVE

As the colours of the wires in the mains lead of this apparatus may not correspond with the coloured markings identifying the terminals in your plug, proceed as follows: The wire which is coloured BLUE must be connected to the terminal which is marked with the letter N or coloured BLACK. The wire which is coloured BROWN must be connected to the terminal which is marked with the letter L or coloured RED. Making sure that neither core is connected to the earth terminal of the three pin plug.

### IMPORTANT

Please record the serial number of this system in the space below.

Model:

Serial No.:

The serial number is located on the rear of the main unit. Retain this Owner's Manual in a safe place for future reference.

### WARNING

TO REDUCE THE RISK OF FIRE OR ELECTRIC SHOCK, DO NOT EXPOSE THIS APPLIANCE TO RAIN OR MOISTURE.

### WARNING

To reduce the risk of fire or electric shock, do not expose this system to rain or moisture.

To avoid electrical shock, do not open the cabinet. Refer servicing to qualified personnel only.

### CAUTION

Use of controls or adjustments or performance of procedures other than those specified herein may result in hazardous radiation exposure.

As the laser beam used in this system is harmful to the eyes, do not attempt to disassemble the cabinet. Refer servicing to qualified personnel only.

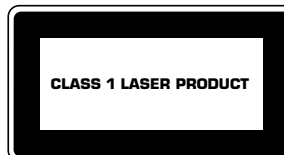

This system is classified as a CLASS 1 LASER product. The CLASS 1 LASER PRODUCT label is located on the rear exterior.

Laser component in this product is capable of emitting radiation exceeding the limit for Class 1.

## General

- High Power Output  
80W + 80W (6Ω) RMS, 0.9% THD, 1 kHz
- Multi-use Timer/Sleep Timer
- SUBWOOFER Output for Low Frequency Expansion
- Remote Control Capability
- YMERSION
- BASS BOOST
- 5-Band Spectrum Analyzer
- 3 Preset Graphic Equalizer Modes (ROCK, POPS and JAZZ)

## Compact Disc Player

- 3-Disc Carousel Type CD Changer
- PLAYXCHANGE  
Disc changing while playing
- 20-Track Random Access Programming
- Repeat Play for Single Track/Entire Disc/ All Discs
- Random Sequence Play

## Tape Deck

- Automatic Synchronized Recording with CD
- EDIT Function Useful for Recording CD(s)
- Automatic Reverse
- Dolby B Type Noise Reduction System

## Tuner

- 40 Station Preset Tuning
- Automatic Preset Tuning
- Multi-Function RDS Reception

# Preparations and connections

## Installing batteries in the remote control

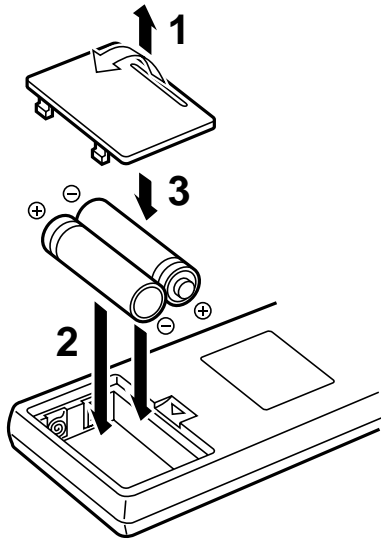

1. Turn the remote control over and remove the battery compartment cover by pulling it up while pressing the edge of the cover in the direction of the  $\nabla$  mark.
2. Insert the batteries (AA, R6, UM-3 type) according to the polarity markings on the inside of the battery compartment.
3. Attach the battery compartment cover.

### Notes

- Remove the batteries if the remote control is not used for an extended period of time.
- If batteries leak, dispose of them immediately. Avoid touching the leaked material and contact with clothing, etc. Clean the battery compartment thoroughly before installing new batteries.
- Be sure to use the same type of batteries together.
- Do not use a new battery and an old battery together.

## Remote control operation range

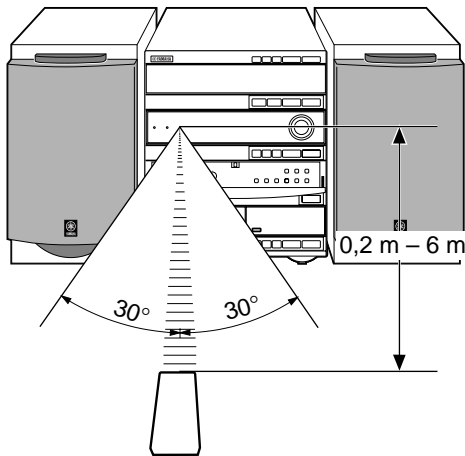

### Notes

- The area between the remote control and the main unit must be clear of large obstacles.
- Do not expose the remote control sensor to strong lighting, in particular, an inverter type fluorescent lamp. Otherwise, the remote control may not work properly. If necessary, position the main unit away from direct lighting.

### Battery replacement

If you find that the remote control must be used closer to the main unit, the batteries are weak. Replace both batteries with new ones.

## Connections

Never plug the AC supply lead of this system into the AC outlet until all connections are completed.

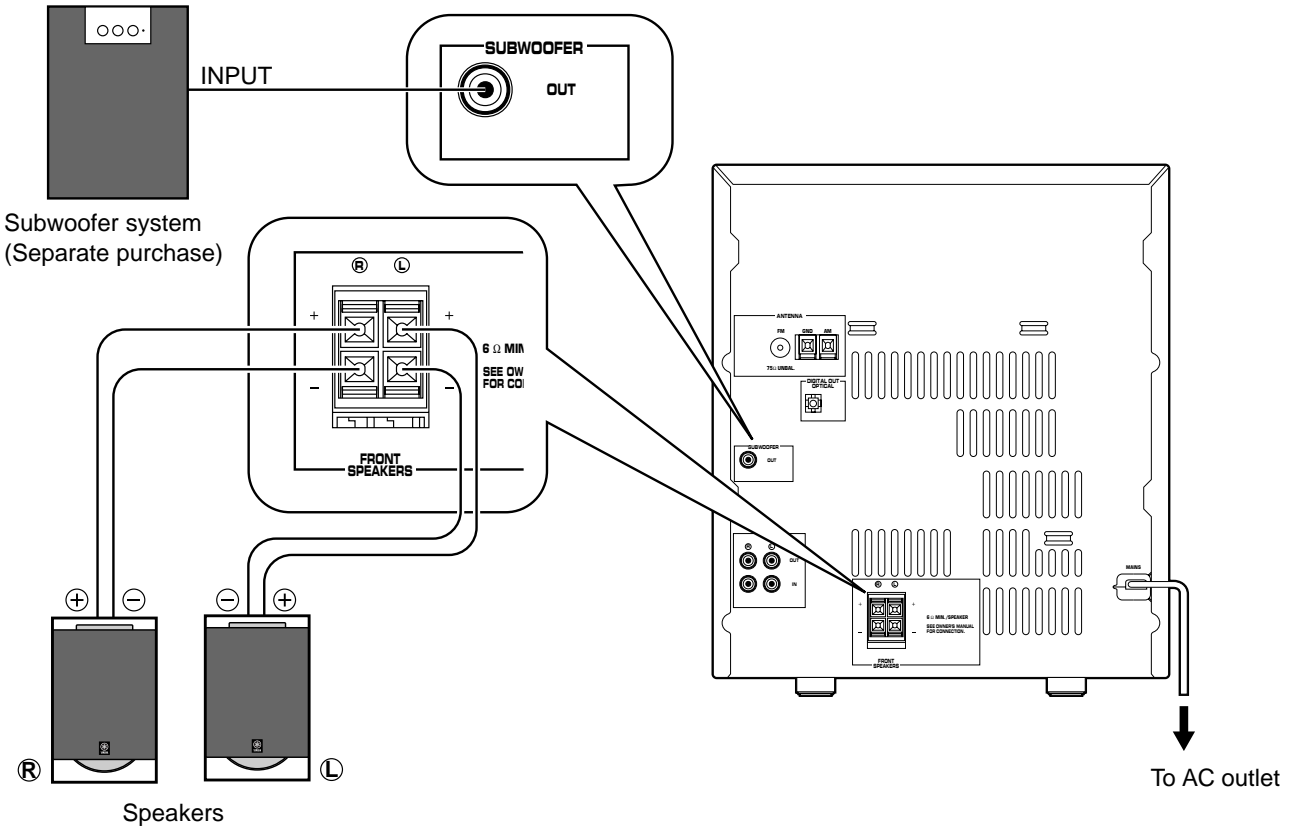

### ■ Connecting speakers

Connect the speakers to the corresponding speaker terminals on the rear of the main unit respectively by using the speaker cords. Make sure that the polarity of the speaker cords is correct, that is the + and – markings are observed. If these cords are reversed, the sound will be unnatural and lack bass.

#### On the speakers

Red: positive (+)  
Black: negative (–)

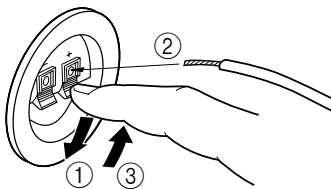

- ① Press the tab
- ② Insert the bare wire.  
[Remove approx. 5mm (1/4") insulation from the speaker wires.]
- ③ Release the tab and secure the wire.

#### On the main unit

Red: positive (+)  
Black: negative (–)

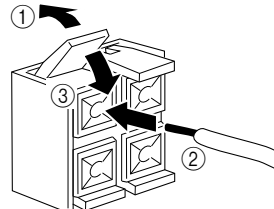

- ① Press up the tab.
- ② Insert the bare wire.  
[Remove approx. 5mm (1/4") insulation from the speaker wires.]
- ③ Press down the tab and secure the wire.

#### Caution

Do not let the bare speaker wires touch each other as this could damage the amplifier and/or speakers.

#### When connecting a subwoofer (separate purchase)

You may wish to add a subwoofer to reinforce the bass frequencies.

When connecting a subwoofer to this system, connect the SUBWOOFER OUT terminal of this system to the INPUT terminal of the subwoofer.

\* Ordinary subwoofers, including the Yamaha Active Servo Processing Subwoofer System, are designed so that the amplifier and subwoofer are in the same unit.

\* The SUBWOOFER OUT terminal outputs low frequencies from both left and right channels.  
(The cut-off frequency of this terminal is 200 Hz.)

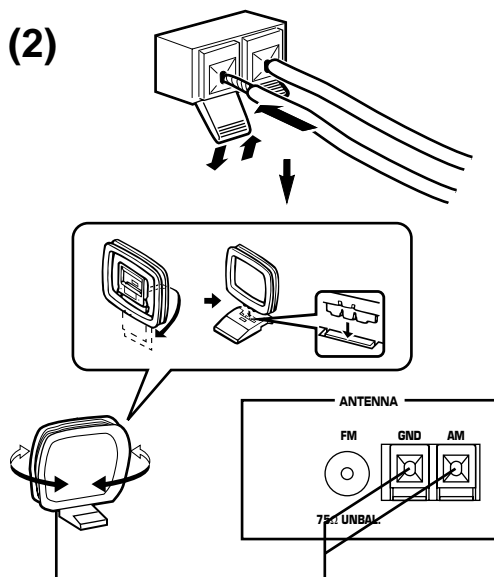
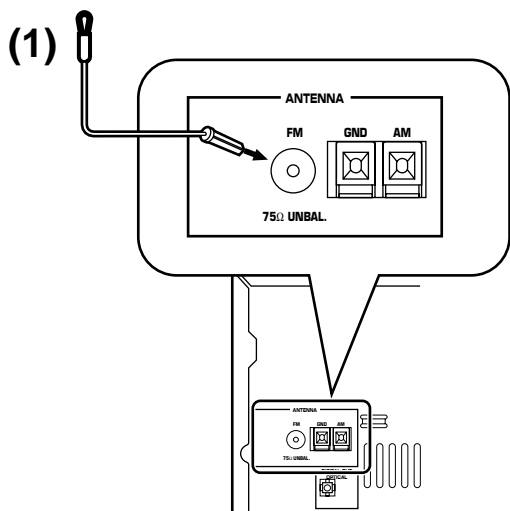

## Antenna connection

### (1) Supplied FM antenna

Connect the FM antenna wire to the corresponding terminal and direct the FM antenna wire to the direction where the strongest signal can be received.

### (2) Supplied AM loop antenna

Connect the AM loop antenna wires to the corresponding terminals. Position the AM loop antenna for optimum reception.

#### Notes

- When static is still heard even after adjusting the position of the AM loop antenna, try reversing the wire connections (from the right terminal to the left one, and vice versa).
- The AM loop antenna should be placed apart from the main unit. The antenna may be hung on a wall.

### Using an external antenna

- Use an external FM antenna instead of an indoor FM antenna if you need better reception. Consult your dealer.
- Use an external AM antenna if you need better reception. Consult your dealer.

## Connecting an external component

This system can be connected with an external audio component. Make connections between this system and the component using RCA pin plug connector cables correctly, that is to say L (left) to L and R (right) to R. Also, refer to the owner's manual for the component to be connected to this system.

- \* A digital-to-digital recording is possible from a CD played on the built-in CD player to an MD (or tape) on an external MD recorder (or DAT) by connecting the DIGITAL OUT (OPTICAL) terminal on the rear of the main unit to the MD recorder (or DAT).

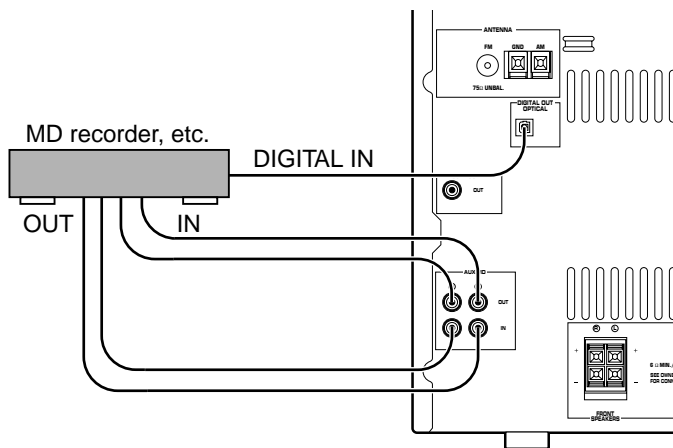

## Setting the clock

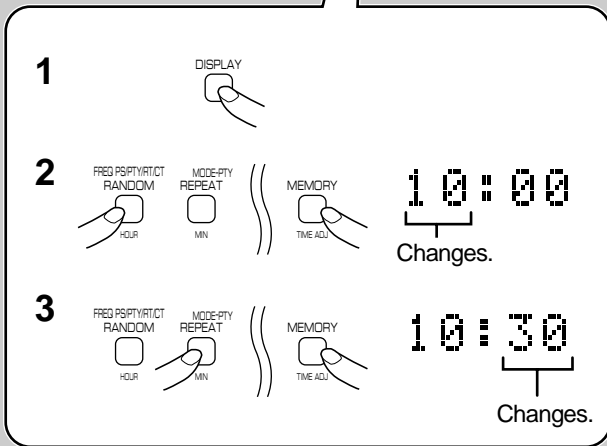
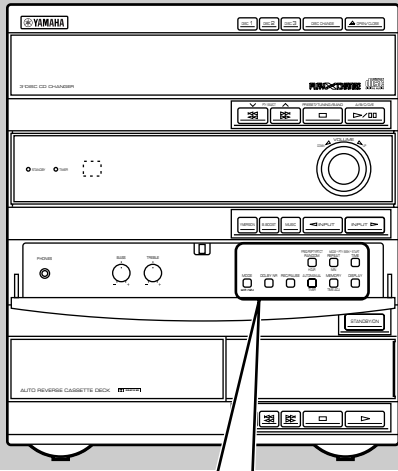

- 1** While the power is on, press **DISPLAY** to display the time.
- 2** While holding **TIME ADJ** pressed, press **HOUR** and set the hour.
  - \* Press **HOUR** once to advance the time by 1 hour. Press and hold to advance continuously.
- 3** While holding **TIME ADJ** pressed, press **MIN** and set the minute.
  - \* Press **MIN** once to advance the time by 1 minute. Press and hold to advance continuously.
  - \* The hour setting will not advance even if minute is advanced from "59" to "00".

### Note

In the event of a power failure or when the AC supply lead is disconnected, the time display will go out, however, the clock will function for about 5 minutes without any power supply. Otherwise, the time display will flash on and off to indicate that the time must be reset.

## Adjusting brightness of the display

If desired, you can adjust the brightness of the display.

Press and hold **DISPLAY** for more than 2 seconds so that "DIMMER ±0" appears on the display. While holding **DISPLAY** pressed, turn **VOLUME** clockwise to increase or counterclockwise to decrease brightness.

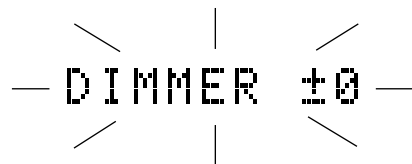

**Control range:** ±0 to -6 (Preset value: ±0)

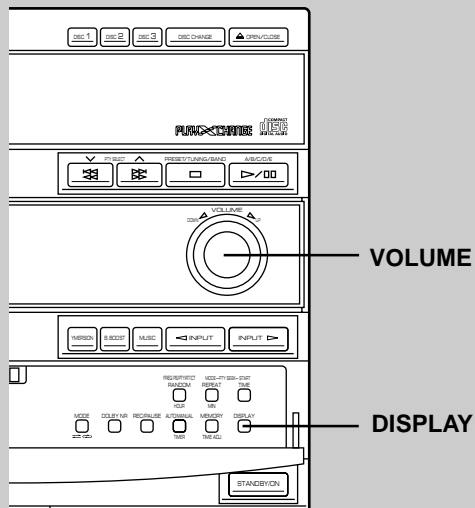

# Compact disc player operation

## Display information

Each indicator mentioned with a number on pages 9 –13 corresponds to the indicator with the same number on this page.

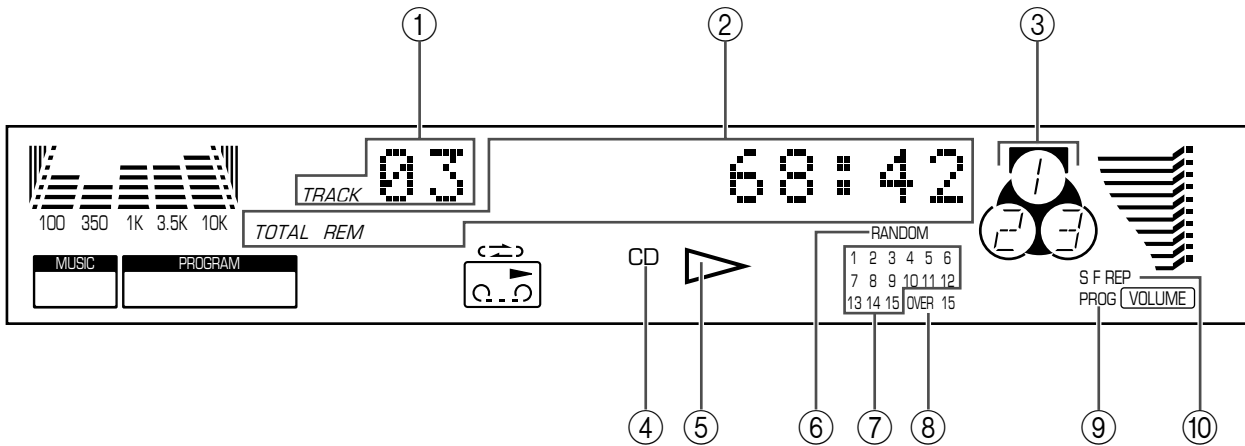

① **TRACK (track number)**

② **Time display**

③ **Disc indicator**

The disc of the number located on the top of this indicator is now being selected.

④ **CD (input source indicator)**

⑤ **▷ (play)**

⑥ **RANDOM**

⑦ **Music calendar**

Track numbers on the currently selected disc will be illuminated (up to the number 15).

⑧ **OVER 15**

This indicator will be illuminated when the currently selected disc has more than 15 tracks.

⑨ **PROG (program)**

⑩ **(S, F) REP [(single, full) repeat]**



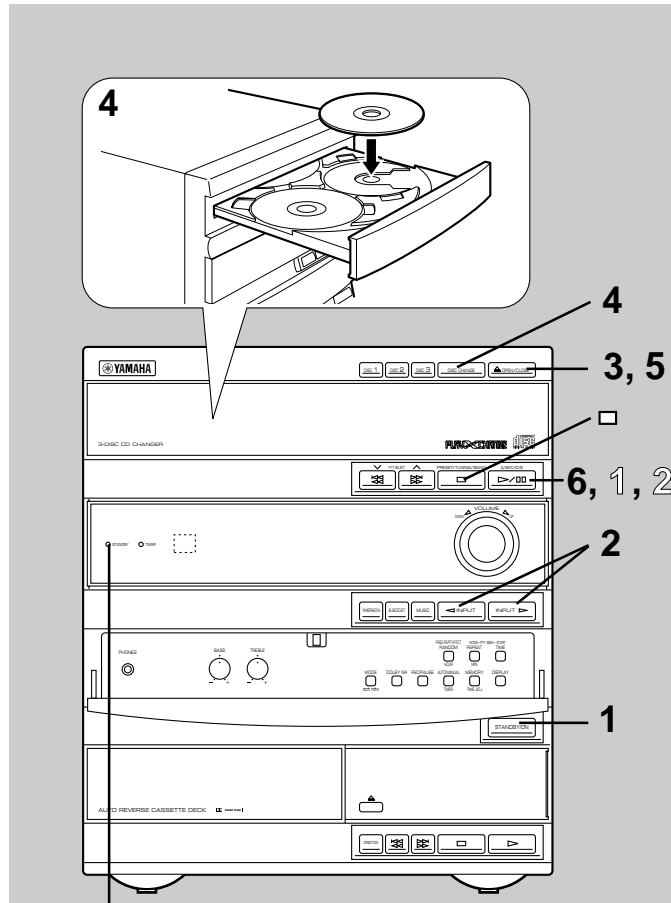

STANDBY indicator

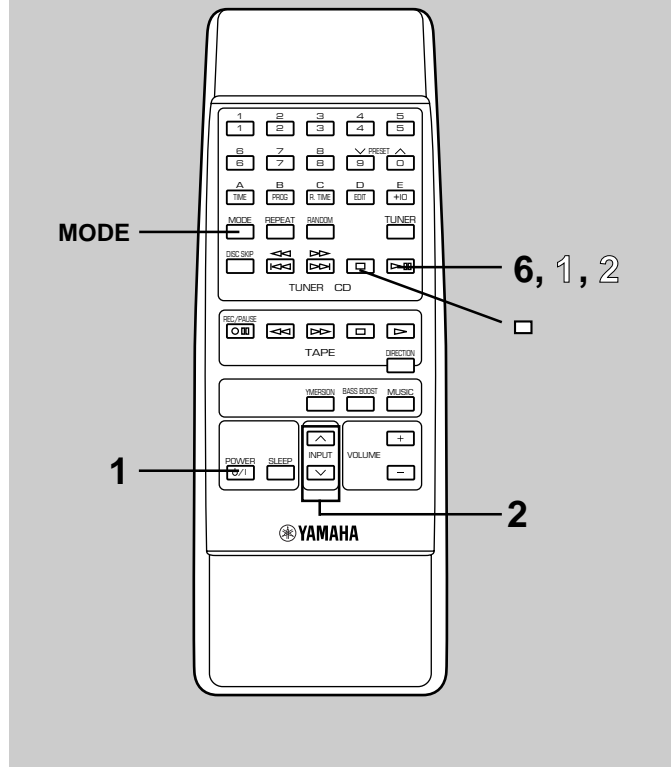

## Basic play

- 1 Turn on the power.
- 2 Select the CD player by pressing **INPUT** ▷ or ◁ until "CD" (②, ④) appears on the display.
- 3 Press **OPEN/CLOSE** to open the disc tray.
- 4 Place discs on the table, label side upward.
  - \* Up to three discs can be loaded on the table.
  - To load the third disc, rotate the disc table by pressing **DISC CHANGE** on the front panel.
  - \* 8 cm (3") discs can be played without an adaptor.
  - \* The disc placed on the left side is played first.
- 5 Press **OPEN/CLOSE** to close the disc tray.
  - \* The total number of tracks (①) and the total playing time of the disc being selected (②) will be displayed for several seconds.
  - \* If the compact disc contains more than 15 tracks, the "OVER 15" indicator (⑧) will light up.
  - \* If the disc tray is closed by pushing the front edge of the tray, play will begin automatically.
- 6 Press ▷/⏸ to begin play.

### To pause

- 1 Press ▷/⏸.
  - \* The "▷" indicator (⑤) will flash.
- 2 Press ▷/⏸ to resume play from the same point.

### To stop play

Press □.

### To finish using this system

Turn this system into the standby mode by pressing **STANDBY/ON**. (The **STANDBY** indicator will light up and the display will go out.)

### Direct operation

**DISC** (1, 2 or 3) and **OPEN/CLOSE** on the front panel and ▷/⏸ on the remote control will work if they are pressed when this system is in the standby mode or another input source is selected.

## To change the disc play mode

If necessary, change the disc play mode by pressing **MODE** on the remote control.

- Single disc play mode:** Only the designated disc is played.
- All disc play mode:** All discs on the disc tray are played sequentially.

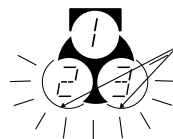

Lights up only when the all disc play mode is selected.



## Compact disc player operation

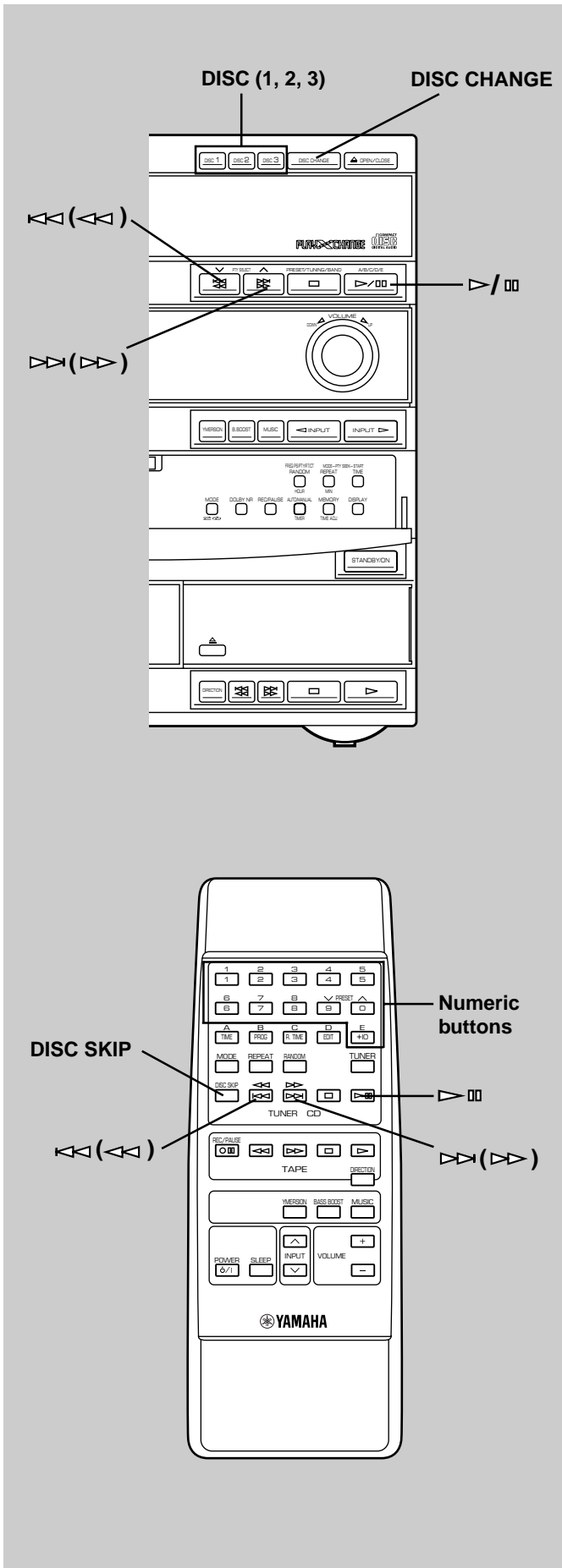

### To select another disc

Press **DISC SKIP** on the remote control once or more (so that the corresponding disc number is located on the top of the disc indicator (③)).

Pressing **DISC (1, 2 or 3)** will select the disc directly, and play will begin from track 1 automatically.

### To select the desired track directly

By using the numeric buttons on the remote control, any track you wish to listen to can be played directly.

Use the numeric buttons to select the desired track number. Play will begin automatically.

**A. For example, to choose track 5**  
Press **5**.

**B. For example, to choose track 12**  
(1) Press **+10**.  
(2) Within a few seconds, press **2**.

**C. For example, to choose track 20**  
(1) Press **+10**.  
(2) Within a few seconds, press **+10** again.  
(3) Within a few seconds, press **0**.

#### Note

If you select a track number higher than the number of tracks on the disc, only the last track of the disc may be played.

### To play the desired track (Skip)

Press **▷▷** to skip forward or **◀◀** to skip backward. Press once for each track to be skipped.

#### Note

This function can also be performed while the CD player is stopped. Press **▷/00** when the desired track number appears on the track number display. Play will begin from the beginning of the track.

### To advance or reverse play rapidly (Search)

Press and hold **▷▷** to advance play rapidly, and **◀◀** to reverse play rapidly.

### To exchange a disc (or discs) while playing (PLAYXCHANGE)

During play, you can open the disc tray by pressing **DISC CHANGE** without interrupting play. However, in this case, pressing **DISC SKIP** or **DISC (1, 2 or 3)** is invalid.



## Program play

You can program up to 20 tracks in any desired order.

- When the CD player is stopped, press **PROG** to prepare for programming.
  - \* "PROG" (9) and "P-01" (2) will light up on the display, and all track numbers on the selected disc (7) will begin flashing.
- If necessary, select the desired disc by pressing **DISC SKIP**.
  - \* Just after you change the disc, the CD player reads the contents of the newly selected disc for a few seconds. During this internal operation, if you go on to the next step, "WAIT" (2) appears on the display and your operation is canceled.
- Use the numeric buttons to select the desired track number.
  - \* The selected track number (1) and the total play time of the programmed tracks (2) will light up on the display, and soon it will be replaced by the display of the next play order (2). Programmed track numbers on the selected disc will stop flashing and light up on the music calendar (7).
  - \* Pressing **TIME** displays the total play time of the programmed tracks (2) for about 1 second, and then it is replaced by the display of the next play order (2).

- Repeat steps 2 and 3 to program other tracks.
- Press **▶/▶** to start the program play.

### Notes

- The total time of the programmed tracks will not be displayed, if track number 16 or higher is programmed.
- Skip (◀◀/ ▶▶) can be performed during play, but only within the range of the programmed tracks.
- Search (◀◀/ ▶▶) can be performed during play to search all tracks, including unprogrammed tracks.

### To cancel a programmed sequence

There are several methods as described below.

- Press **□** while the CD player is stopped.
- Open the disc tray.
- Turn this system into the standby mode.

### To check (and correct) program data

- Press **PROG** when the CD player is stopped.
- Every time **▶▶** is pressed, the track numbers and sequential order of the programmed tracks can be checked one after another. The display of the track number can be returned (sequentially in reverse order) by pressing **◀◀**.
- If you want to correct the program data, press a numeric button to select the track to replace the one displayed. The previously programmed track will be cleared from the memory and the new one will be programmed. To complete the correction, press **PROG** or **▶/▶** once again.

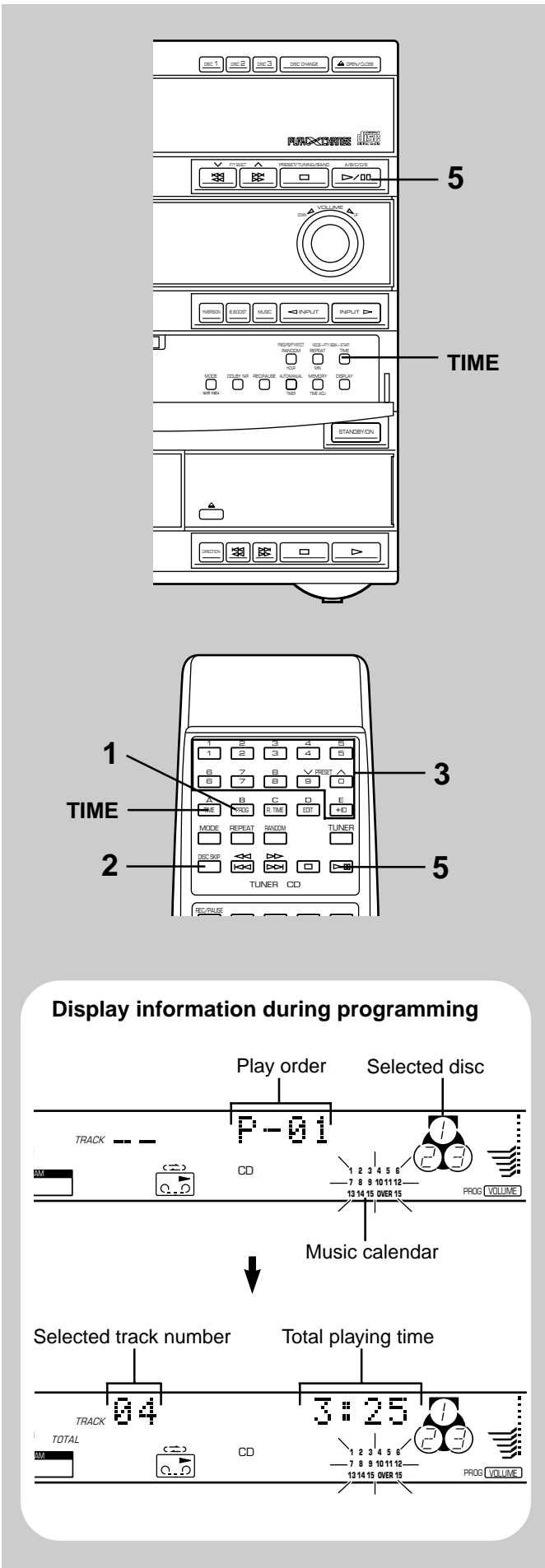

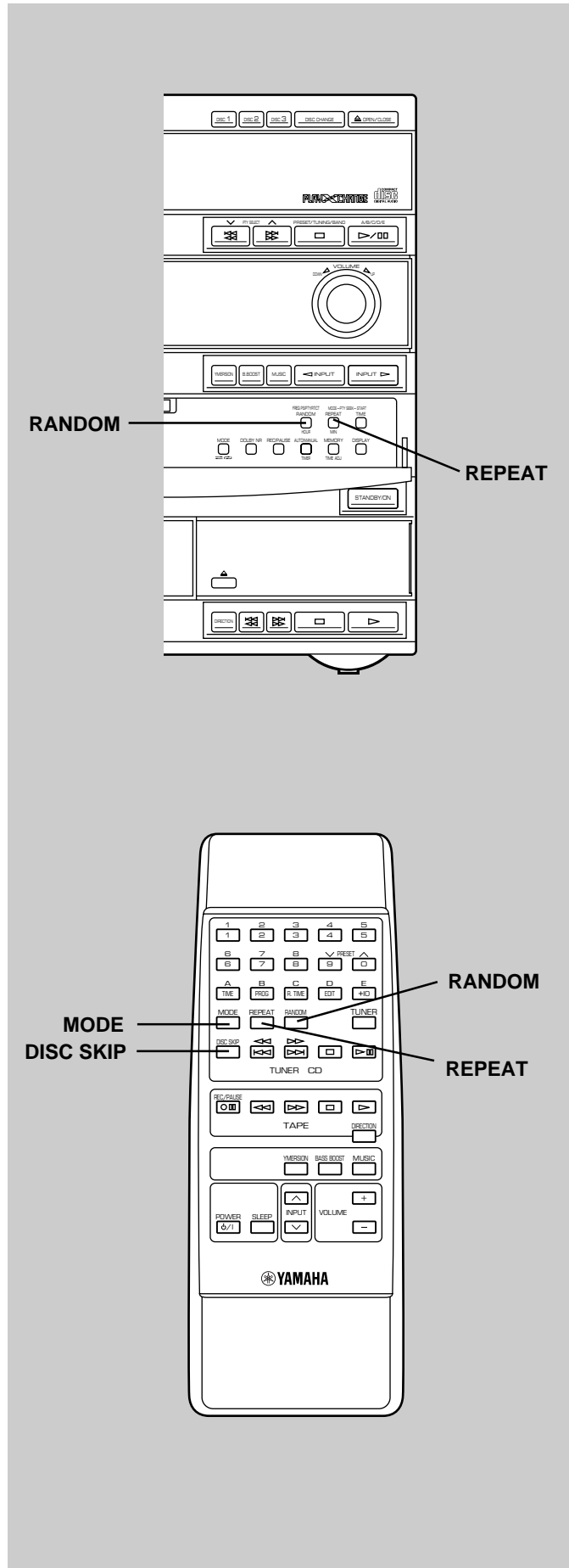

## Random play

Tracks on a selected disc or all discs on the disc tray can be played randomly.

**1** If necessary, switch the disc play mode by pressing **MODE**.

\* If the single disc play mode is selected, select the desired disc by pressing **DISC SKIP**.

**2** Press **RANDOM** to begin random play.

\* The "RANDOM" indicator (⑥) will light up.

### To cancel the random play

Press **□**, or press **RANDOM** so that the "RANDOM" indicator (⑥) will go out.

### Note

This feature will not function during programming or program play.

## Repeat play

All discs, a disc, a single track or a programmed sequence can be continuously repeated.

Press **REPEAT** once or more to select the desired repeat play mode so that the S REP or F REP indicator (⑩) is illuminated.

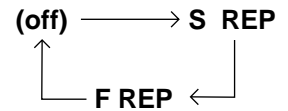

### Repeat play modes

#### SINGLE REPEAT (S REP)

A single track is played repeatedly.

\* This is also available in the program play mode and the random play mode. (If the repeat play mode is switched off, the program play mode or the random play mode will be resumed.)

#### FULL REPEAT (F REP)

#### When the CD player is in the single disc play mode:

The designated disc is played repeatedly.

\* In the random play mode, the selected disc is repeatedly played, but the order of tracks is different every time.

#### When the CD player is in the all disc play mode:

All discs on the disc tray are played repeatedly.

\* In the random play mode, the random play is performed among all discs and repeated with a different order of tracks every time.

### Note

In the program play mode, a sequence of programmed tracks is played repeatedly.

### To cancel the repeat play

Press **REPEAT** once or more so that the (S, F) REP indicator (⑩) goes out.



### Switching the time display

Every time **TIME** is pressed, the display will change as described below.

**[Example]**

When the second track is being played. (Refer to the illustration on the left.)

- 1 The elapsed play time for the current track will be displayed.
- 2 The remaining play time for the current track will be displayed.
- 3 The total play time of the disc will be displayed.
- 4 The total remaining play time of the disc will be displayed.

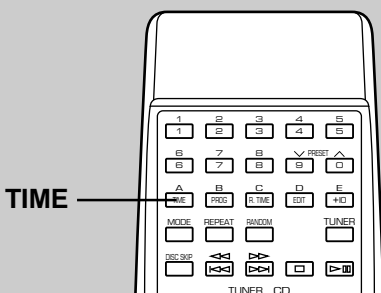
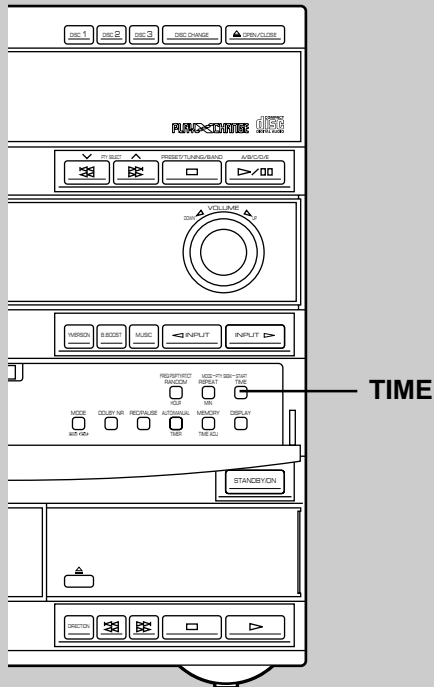
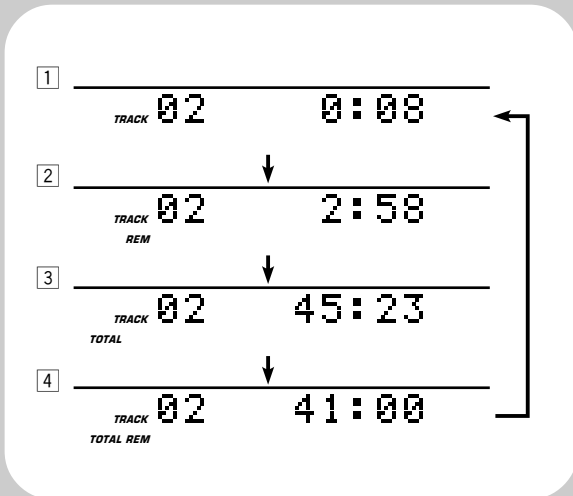

# Tuning operation

## Display information

Each indicator mentioned with a number on pages 15–21 corresponds to the indicator with the same number on this page.

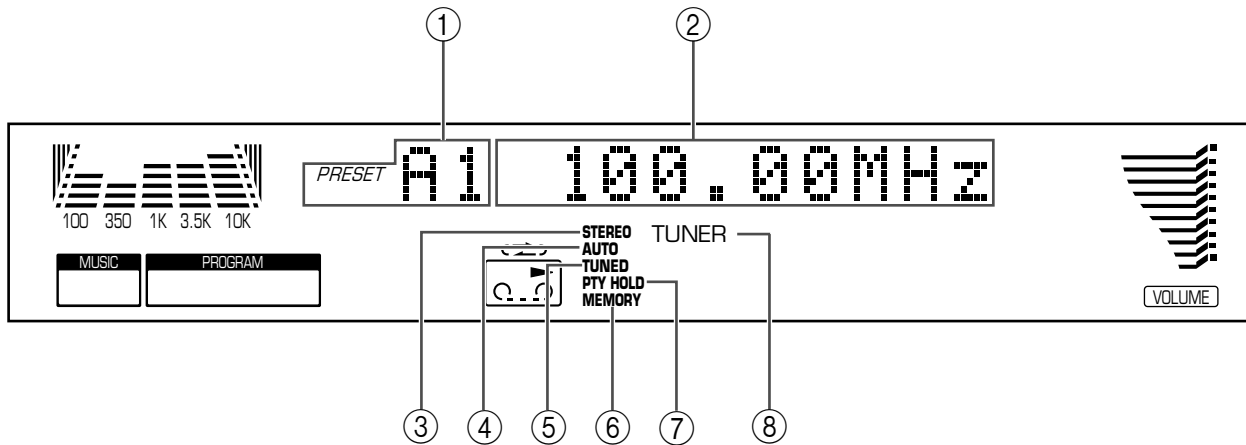

① Preset station group and number indicator

② Multi-information display

③ STEREO

④ AUTO

⑤ TUNED

⑥ MEMORY

⑦ PTY HOLD

⑧ TUNER (input source indicator)



## Automatic tuning

- 1 Turn on the power.
- 2 Press **INPUT**  $\triangleright$  or  $\triangleleft$  until "TUNER" (②, ⑧) appears on the display, or simply press **TUNER** on the remote control.
- 3 Select the reception band (FM or AM) by pressing **PRESET/TUNING/BAND** confirming it on the display (②).  
\* Do not select the preset tuning mode (in which "PRESET" (①) lights up on the display).
- 4 Press **AUTO/MANUAL** so that "AUTO" (④) lights up on the display.
- 5 Press  $\wedge$  to tune to a higher frequency, or press  $\vee$  to tune to a lower frequency.  
(When tuned in to a station, "TUNED" (⑤) will light up on the display.)
- 6 If the station where tuning search stopped is not the desired one, follow step 5 again.  
  
\* If the tuning search does not stop at the desired station, change to the Manual tuning method as described below.  
\* "STEREO" (③) will light up when an FM stereo broadcast with sufficient signal strength is received.

## Direct operation

**TUNER** on the remote control will work if it is pressed when this system is in the standby mode or another input source is selected.

## Manual tuning

- 1 Follow steps 1 to 3 of the Automatic tuning method.
- 2 Press **AUTO/MANUAL** so that "AUTO" (④) disappears from the display.
- 3 Press and hold  $\wedge$  to tune to a higher frequency, or press and hold  $\vee$  to tune to a lower frequency. Release it just before reaching the desired frequency, and then press it repeatedly until the desired frequency appears.  
(When tuned in to a station, "TUNED" (⑤) will light up on the display.)

### Note

If you tune in to an FM station manually, it is received in monaural to increase the signal quality.

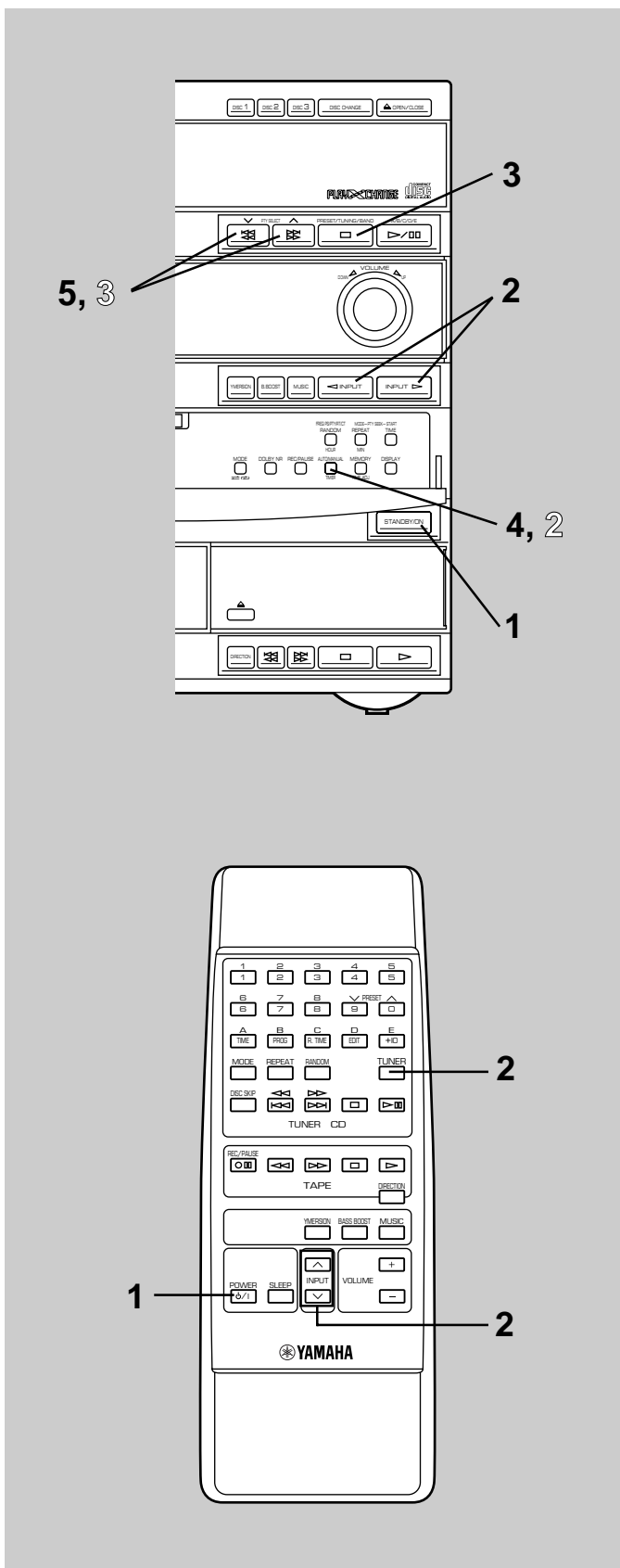



## Tuning operation

### Manual preset tuning

The built-in tuner can store station frequencies selected by tuning operation. With this function, you can select any desired station only by calling the corresponding preset station number. Up to 40 stations (8 stations x 5 groups) can be stored.

#### ■ To store stations

- 1 Turn on the power.
- 2 Press **INPUT**  $\triangleright$  or  $\triangleleft$  until "TUNER" (②, ⑧) appears on the display, or simply press **TUNER** on the remote control.
- 3 Tune in to the desired station.
- 4 Press **MEMORY**.  
\* "MEMORY" (⑥) and "PRESET" (①) will flash on the display for about 5 seconds.
- 5 Select the desired group (A – E) of preset stations by pressing **A/B/C/D/E** confirming it on the display, before "MEMORY" (⑥) goes out.
- 6 Select a preset station number by pressing  $\vee$  or  $\wedge$  repeatedly or pressing a numeric button (1 to 8) before "MEMORY" (⑥) goes out.
- 7 Within about 5 seconds, press **MEMORY** again.

#### ■ To recall a preset station

- 1 Select a group of preset stations by pressing **A/B/C/D/E**.
- 2 Select the desired preset station number by pressing  $\vee$  or  $\wedge$  repeatedly or pressing a numeric button (1 to 8).

#### Notes

- A new setting can be programmed in place of the former one.
- For presets the setting of **AUTO/MANUAL** is stored along with the station frequency.

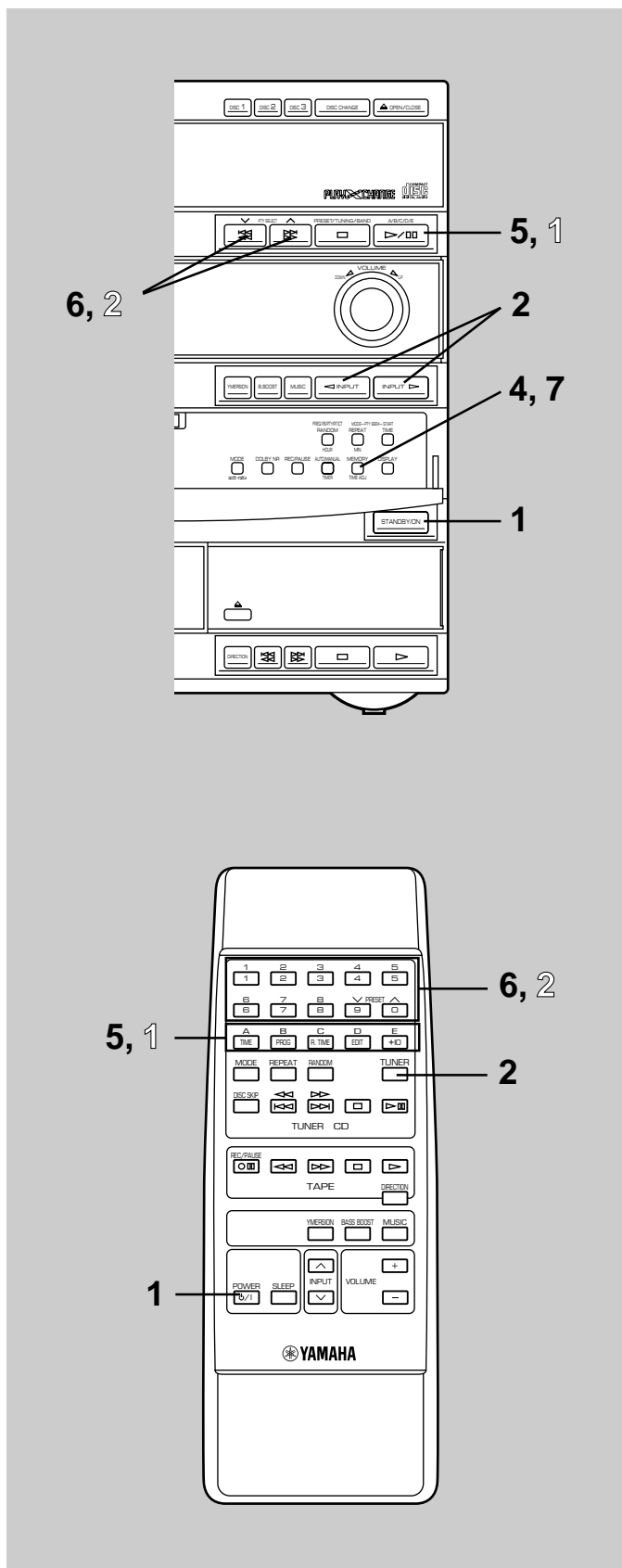



## Automatic preset tuning

You can make use of an automatic preset tuning function. With this function, the built-in tuner performs automatic tuning. Up to 40 stations are stored automatically.

- 1** Turn on the power.
- 2** Press **INPUT**  $\triangleright$  or  $\triangleleft$  until "TUNER" (②, ⑧) appears on the display, or simply press **TUNER** on the remote control.
- 3** Press and hold **MEMORY** for more than 2 seconds.  
\* The "MEMORY" (⑥) and "AUTO" (④) indicators flash.

The tuner performs automatic tuning and searches FM and AM stations in that order. Received stations are programmed to A1, A2 ... A8 sequentially.

### When the automatic preset tuning is completed;

The display shows the frequencies of the first preset station (stored to A1).

If you want to check the contents and the number of preset stations, follow the procedure of the section "To recall a preset station" on the previous page.

### To recall a preset station

Simply follow the procedure of the section "To recall a preset station" on the previous page.

### Notes

- The automatic preset tuning search will be performed through all frequencies until 40 stations are stored. If the number of received stations is less than 40, the search will stop after searching all frequencies.  
\* Since FM stations are searched for first, there may be a case that 40 preset stations are occupied by FM stations only.
- The tuner is originally set to search only RDS stations instead of all FM stations by this operation. (FM stations that employ no RDS network service cannot be programmed.)  
However, you can change the setting so that the tuner can program not only RDS stations but also other FM stations. (Refer to page 21 for details.)
- With this function, only stations with sufficient signal strength are stored automatically. If the station you want to program is weak in signal strength, tune in to it with the Manual tuning method (in monaural) and program it by following the procedure of the section "To store stations" on the previous page.
- You can replace a preset station with another FM or AM station manually by simply following the procedure of the section "To store stations" on the previous page.

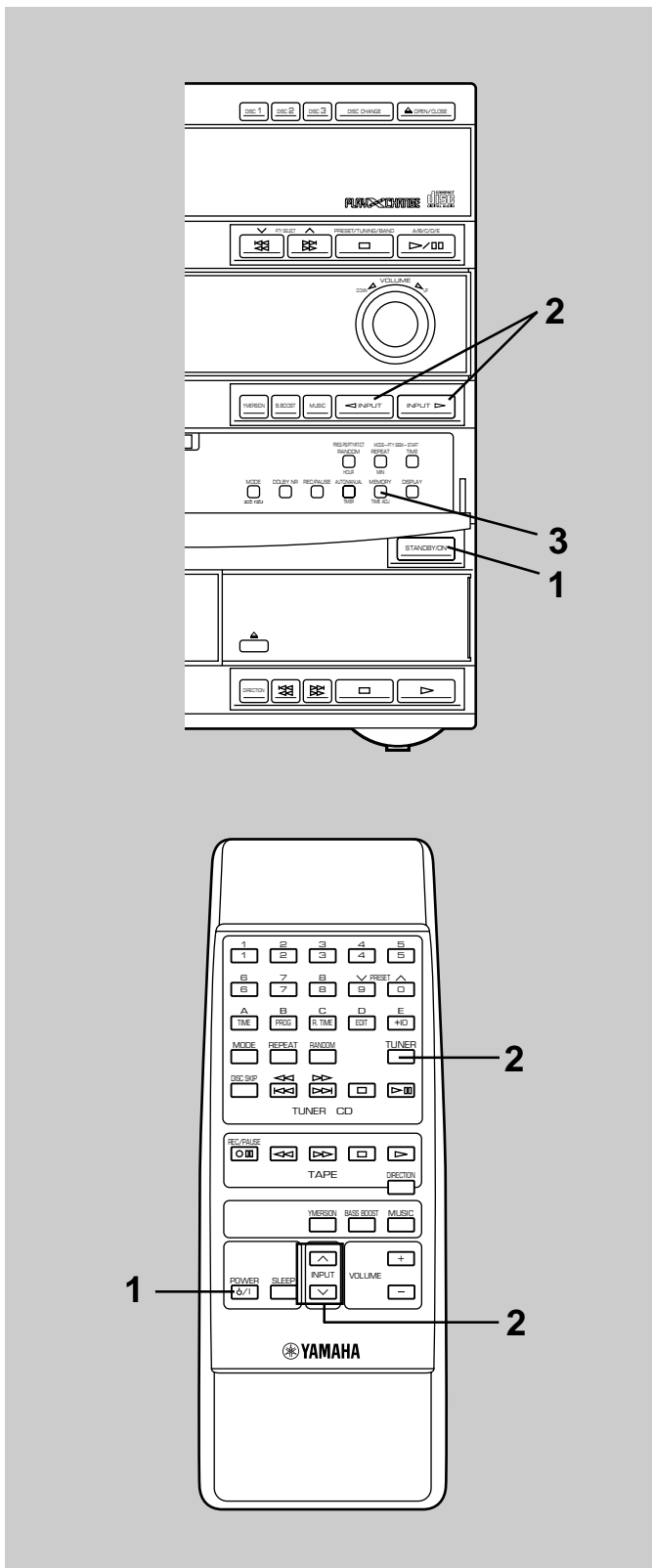

### Memory back-up

The memory back-up circuit prevents the programmed data from being lost even if the AC supply lead is disconnected from the AC outlet or the power is cut due to temporary power failure. If, however, the power is cut for more than one week, the memory may be erased. If so, it can be re-programmed by simply following the Preset tuning steps.



## Receiving RDS stations

RDS (Radio Data System) is a data transmission system employed by FM stations in many countries. Stations using this system transmit an inaudible stream of data in addition to the normal radio signal.

RDS data contains various information, such as PI (Program Identification), PS (Program Service name), PTY (Program Type), RT (Radio Text), CT (Clock Time), etc.

RDS function is carried out among the network stations.

\* The built-in tuner utilizes PS, PTY, RT and CT to receive RDS broadcast stations.

### ■ RDS modes

The built-in tuner uses the following four modes to display RDS data.

#### PS (Program Service name) mode

#### PTY (Program Type) mode

There are 15 program types to classify RDS stations as described below.

#### RT (Radio Text) mode

#### CT (Clock Time) mode

### PTY modes

<b>NEWS</b>	News	<b>VARIED</b>	Light entertainment
<b>AFFAIRS</b>	Current affairs	<b>POP M</b>	Pops
<b>INFO</b>	General information	<b>ROCK M</b>	Rock
<b>SPORT</b>	Sports	<b>M.O.R. M</b>	Middle of the road music (easy-listening)
<b>EDUCATE</b>	Education	<b>LIGHT M</b>	Light classics
<b>DRAMA</b>	Drama	<b>CLASSICS</b>	Serious classics
<b>CULTURE</b>	Culture	<b>OTHER M</b>	Other music
<b>SCIENCE</b>	Science		

### ■ Changing the RDS modes

When an RDS station is received, by pressing **FREQ PS/PTY/RT/CT** once or more, you can change the display mode among the RDS modes employed by the received station in the order shown on the next page. (The RDS mode not employed by the station cannot be selected.)

#### Notes

- If the received station is not an RDS station, pressing **FREQ PS/PTY/RT/CT** displays "NO RDS" on the display, and then it returns to the frequency display mode.
- When an RDS station is received, the display is automatically turned into the PS mode. Do not press **FREQ PS/PTY/RT/CT** until the display is turned into the PS mode. If the button is pressed before the display mode changes, it may occur that "NO PS" appears on the display. This is because the tuner has not received all of the RDS data on the station yet.

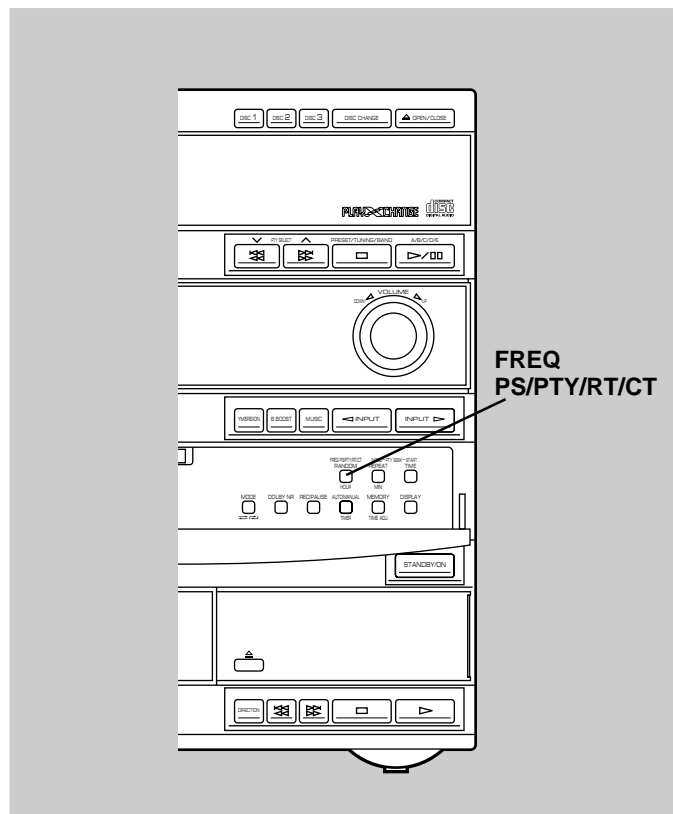

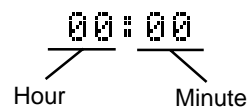
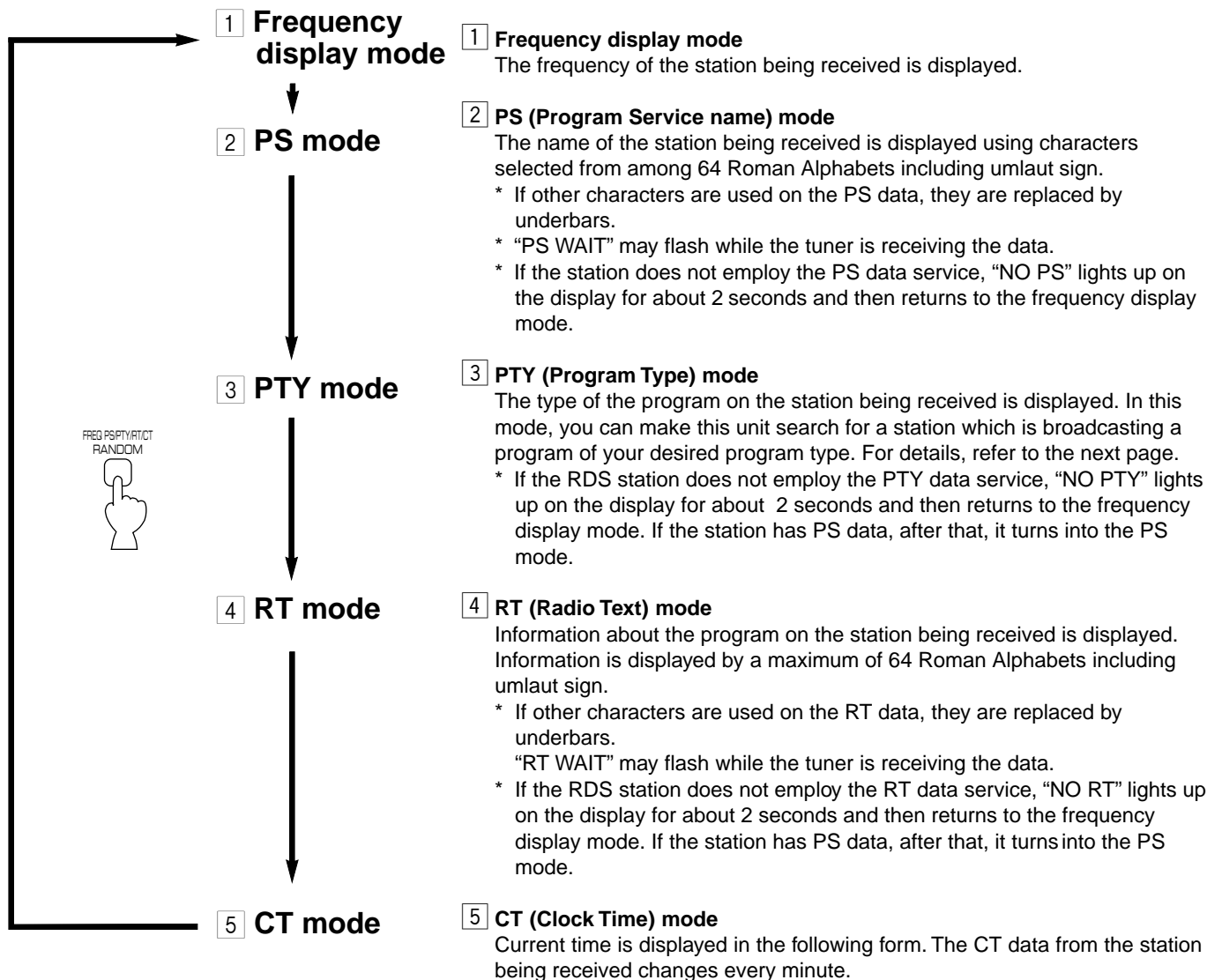

The tuner corrects the time of the built-in clock by synchronizing it with the CT data. (This function can also be canceled, if so desired. Refer to page 21 for details.)

- \* "CT WAIT" may flash while the tuner is receiving the data. If the data is accidentally cut off, "CT WAIT" may flash and then turn into "NO CT".
- \* If the RDS station does not employ the CT data service, "NO CT" lights up on the display for about 2 seconds and then returns to the frequency display mode. If the station has PS data, after that, it turns into the PS mode.

**Notes**

- RDS data service cannot be used if the received signal is not strong enough. Especially, the RT (Radio Text mode) needs much data to be received, so it may occur that RT mode cannot be displayed even if other RDS modes (PS, PTY, etc.) are displayed.
- There may be a case that RDS data reception is not possible due to poor reception conditions. In such a case, press **AUTO/MANUAL** to make tuning manually. Though the reception mode is changed to monaural by this operation, when you change the display to an RDS mode, RDS data may be displayed.
- If the signal strength gets weakened by external interference during receiving an RDS station, the RDS data service may be cut off suddenly and turn into the frequency display mode.

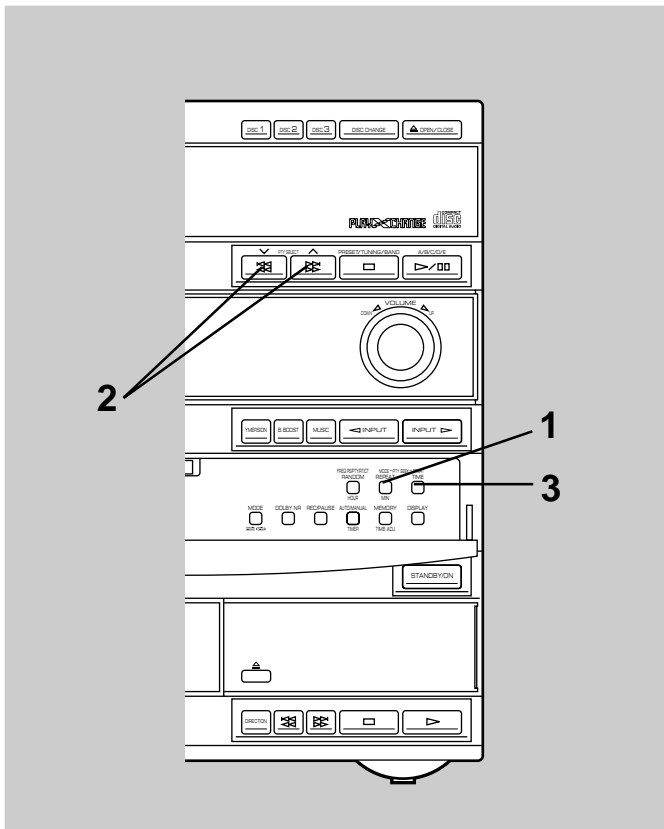

### ■ Calling a program of your desired program type from among preset RDS stations (PTY SEEK)

By designating a program type, the tuner automatically searches all preset FM stations for an RDS station which broadcasts a program of that program type.

\* There are 15 program types to classify RDS stations. For details, refer to page 18.

#### 1 Turn the tuner into the PTY SEEK mode by pressing **PTY SEEK MODE**.

\* The name of the program type of the station now being received or "NEWS" flashes on the display.

#### 2 Select the desired program type by using **PTY SELECT** $\nabla$ or $\wedge$ .

\* If there is no operation for about 20 seconds, this mode is canceled and turns into the frequency display. If the station has PS data, after that, it turns into the PS mode.

#### 3 Press **PTY SEEK START**.

The tuner begins searching all preset FM stations.

\* "PTY HOLD" (⑦) lights up on the display.

\* The name of the program type and "AUTO" (④) flash. The preset station number (①) changes rapidly in sequence.

- If a station which broadcasts a program of the program type is found, the search stops at the station and turns into the frequency display. If the station has PS data, after that, it turns into the PS mode.
- If the called station is not the desired one, press **PTY SEEK START** once more. The tuner begins searching for another station which broadcasts a program of the same program type.
- If no station is found, "NO PTY" appears and then returns to the frequency display. If the station has PS data, after that, it turns into the PS mode.
  - \* If **PTY SEEK START** is pressed once more during searching, this mode is canceled and turns into the frequency display. If the station has PS data, after that, it turns into the PS mode.

#### To cancel the PTY SEEK mode

If **PTY SEEK MODE** is pressed twice, the PTY SEEK mode is canceled and turns into the frequency display. If the station has PS data, after that, it turns into the PS mode.

## Other functions which make use of RDS data service

The tuner has the following functions which make use of RDS data service. These are originally in operation [ON]. However, you can cancel these functions [OFF], if so desired.

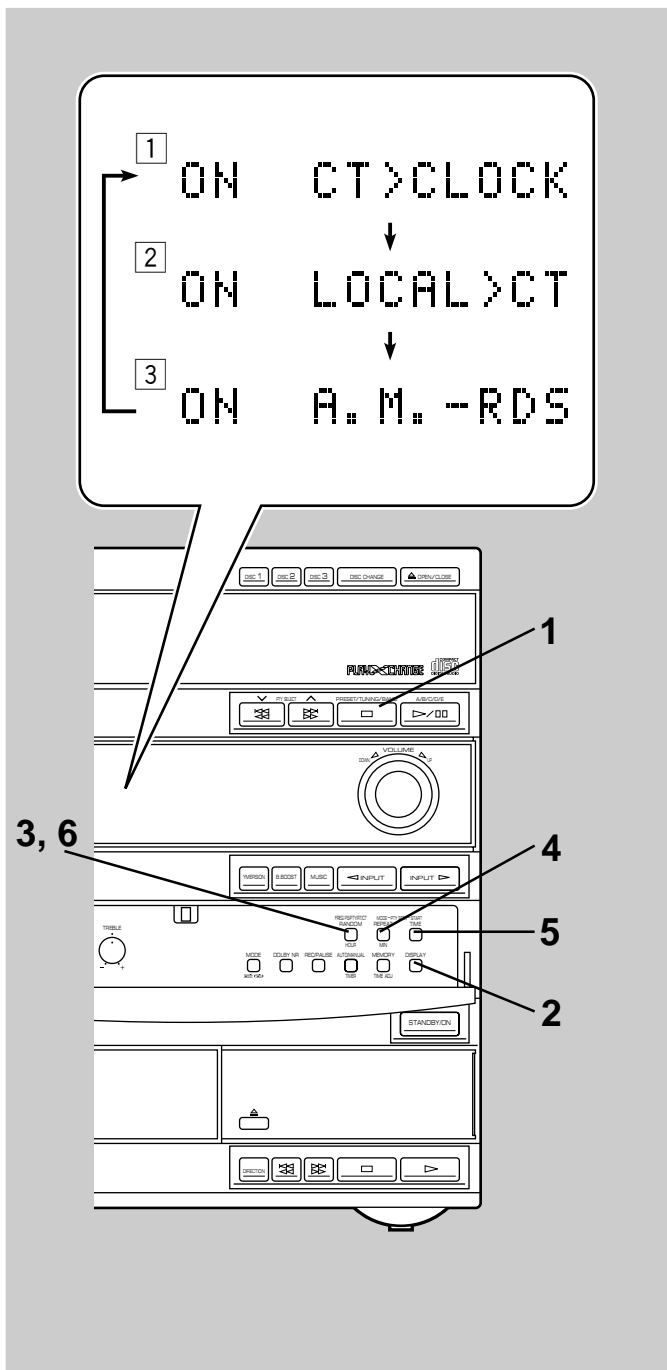

### 1 ON (OFF) CT > CLOCK

The tuner corrects the time of the built-in clock automatically by synchronizing it with the CT data on the RDS station being received.

- \* If you receive an RDS station of some other country, the built-in clock is synchronized with the time setting of the country.
- \* If the built-in clock is not yet set for the current time or reset due to a power failure etc., it will be set for the time of the CT data automatically, whether this setting is ON or OFF.

### 2 ON (OFF) LOCAL > CT

If the RDS station being received employs the local time (summer time etc.) data service, its time is displayed in the CT mode.

- \* If the setting of function 1 is "ON", the built-in clock is synchronized with the local time data.

### 3 ON (OFF) A. M. - RDS (AUTO MEMORY > RDS)

Only RDS stations are searched instead of all FM stations by the automatic preset tuning operation when the setting is ON. (Refer to page 17 for the operating procedure.)

If you switch this function OFF, not only RDS stations but also other FM stations are programmed along with AM stations by the automatic preset tuning operation.

## To switch these functions on and off

- 1 Select the FM band by pressing the **PRESET/TUNING/BAND**, confirming it on the display.
- 2 Press **DISPLAY** to display the current time.
- 3 Press **FREQ PS/PTY/RT/CT**.  
The title of function 1 "ON CT > CLOCK" is displayed.
- 4 Select the title of function whose setting you want to switch by pressing **PTY SEEK MODE** once or more.
- 5 Switch the function ON or OFF by pressing **PTY SEEK START**, confirming it on the display.
- 6 Press **FREQ PS/PTY/RT/CT** again to restore the frequency display mode.  
\* If the station has PS data, after the frequency display mode returns, it turns into the PS mode.

## Notes

- Once the setting is changed, it will be stored until it is changed again by the above operation.
- During the operation, if there is no operation for about 20 seconds, this mode is canceled and turns into the frequency display. If the station has PS data, after that, it turns into the PS mode.

# Playing back a tape

## Display information

Each indicator mentioned with a number on pages 23–29 corresponds to the indicator with the same number on this page.

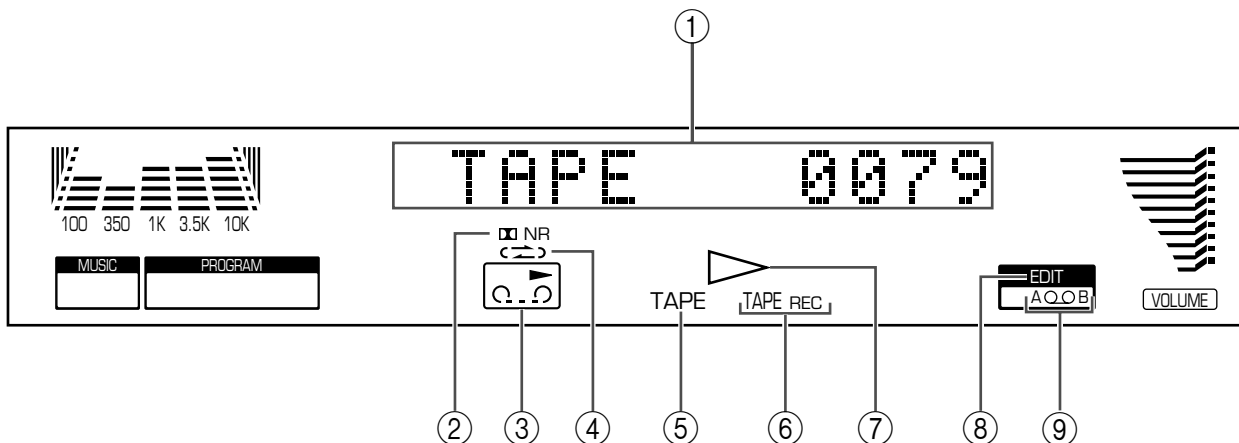

- |                            |                                 |                       |
|----------------------------|---------------------------------|-----------------------|
| ① Tape counter             | ④ Reverse mode indicator        | ⑦ ▷ (play)            |
| ② □ NR (DOLBY NR)          | ⑤ TAPE (input source indicator) | ⑧ EDIT                |
| ③ Tape direction indicator | ⑥ TAPE REC                      | ⑨ Tape side indicator |

## General information

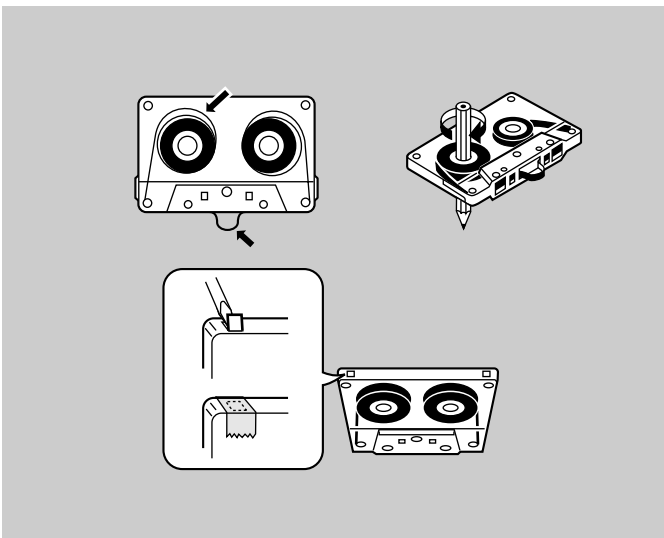

- Do not use C-120 tapes or poor-quality tapes, since they can cause malfunctions.
- Before loading a tape on the tray, tighten the tape slack with a pen or pencil.
- Tapes have removable tabs which prevent accidental recording or erasing from taking place. Removing the tab on the top left protects the side facing you from erasure. Cover the tab holes with adhesive tape to erase or record again.
- The tape deck features an automatic tape selector. Just load the tape, and the tape formula being used will be sensed automatically.
- The tape deck can play back metal tapes as well as normal or chrome tapes, however recording cannot be done on metal tapes with good sound quality.

## Dolby B Type Noise Reduction

Dolby noise reduction is an extremely effective method of reducing undesirable background hiss on tapes. The built-in tape deck incorporates Dolby B type noise reduction system. **DOLBY NR** is useful to both recording and playback; be sure that the same noise reduction is used on recording and playback.

Dolby noise reduction manufactured under license from Dolby Laboratories Licensing Corporation. "DOLBY" and the double-D symbol  are trademarks of Dolby Laboratories Licensing Corporation.

## About the tape counter

The tape deck is equipped with a tape counter that is useful for searching and locating a desired point on the tape. The tape counter is shown on the display. Pressing  (stop) when the deck is stopped will reset the tape counter to "0000".





### Basic operation

- 1 Turn on the power.
- 2 Press **INPUT** ▷ or ◁ until "TAPE" (①, ⑤) appears on the display.
- 3 Open the tray by pressing ▲.
- 4 Load the tape on the tray with side A upward, and close the tray by pressing ▲ or pushing the front edge of the tray gently.
- 5 Press **MODE** or **DIRECTION** to change the current setting if necessary.

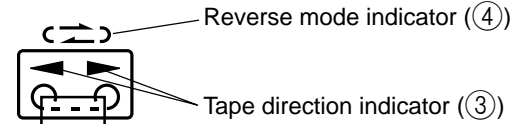

Moves slowly in the current tape running direction during playback.

MODE \ DIRECTION	▶	▶↻	↻▶
Side A only	Side A only	Side A → Side B	Side A → Side B ↑ (Repeats 8 times) Starts from side A.
Side B only	Side B only	Side B only	Side B → Side A ↑ (Repeats 8 times) Starts from side B. (Side A is not played at the first time.)

- 6 Press ▷.  
Playback begins.

**To stop playback**  
Press □.

**To remove the tape**  
Open the tray by pressing ▲.

### Direct operation

▷ and ▲ will work if they are pressed when this system is in the standby mode or another input source is selected.

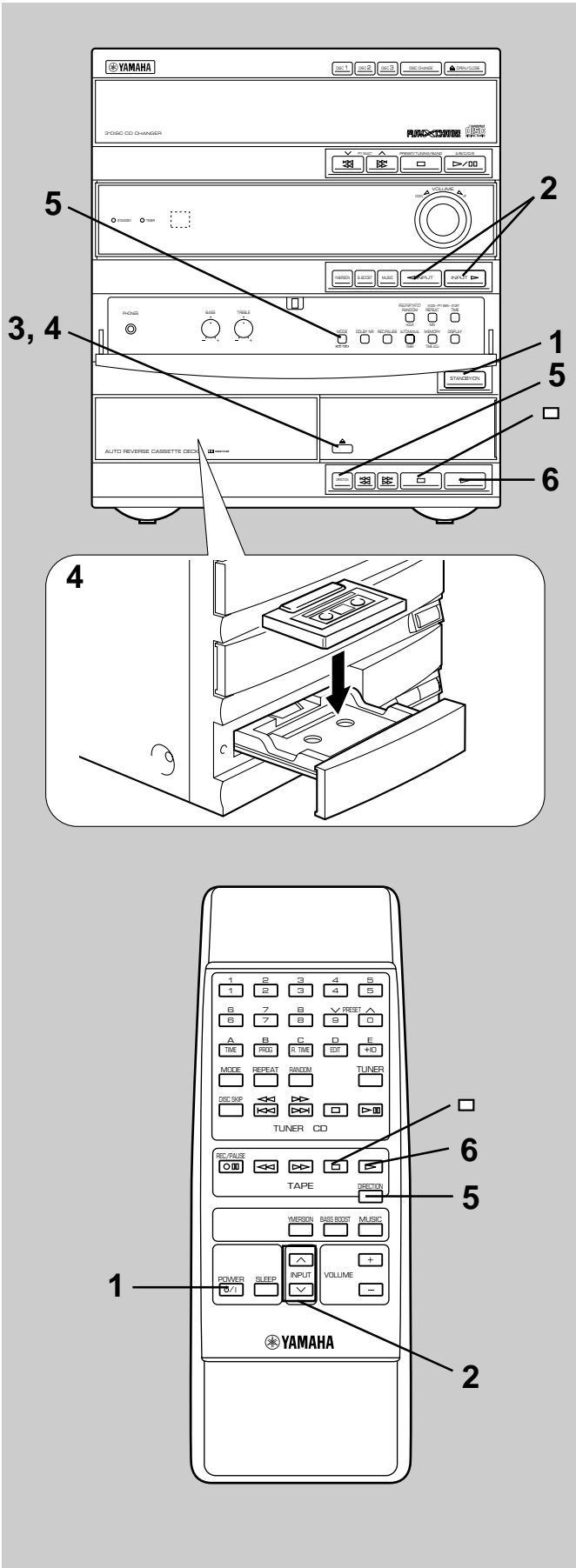



## Playing back a tape

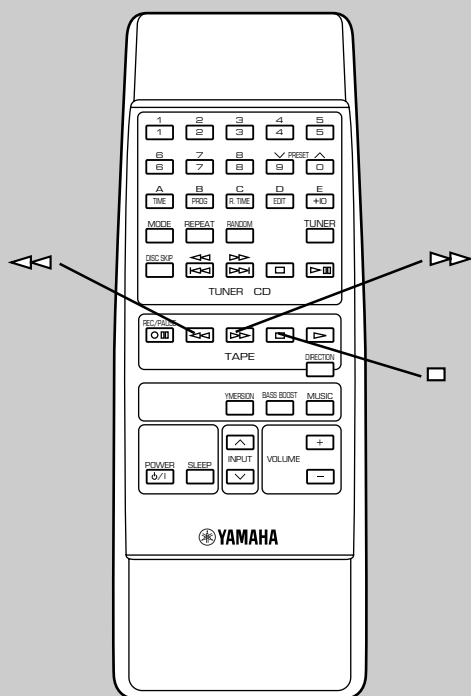
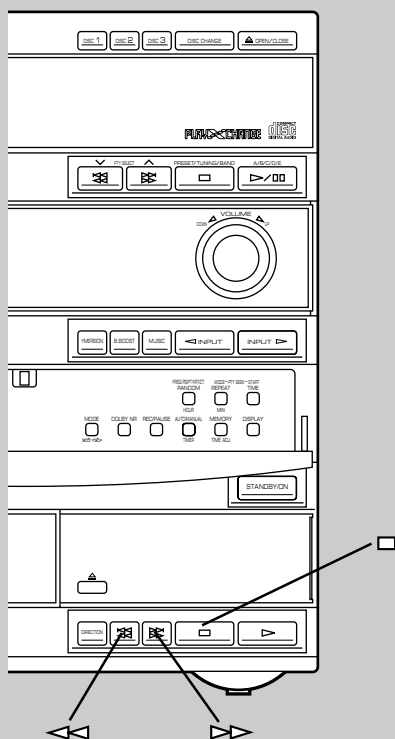

## Winding the tape

1 Press ◀◀ or ▶▶ to wind the tape.

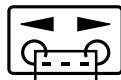

Moves rapidly in the current tape running direction while winding.

2 Press □ to stop.

### Note

When the tape is wound to the end, the tape deck will then function as described below.

- ▶▶ : The tape stops at the end.
- ▶▶ : If the winding direction is ▶, when the tape reaches the end, playback automatically starts from the reverse side.  
If the winding direction is ◀, the tape stops at the end.
- ◀◀ : When the tape reaches the end, playback automatically starts from the reverse side.

## Searching for the beginning of the desired selection

Press ◀◀ or ▶▶ during playback.

### To listen to the same selection

Press ◀◀ if the direction of the current playback is ▶.  
Press ▶▶ if the direction of the current playback is ◀.

### To listen to the next selection

Press ▶▶ if the direction of the current playback is ▶.  
Press ◀◀ if the direction of the current playback is ◀.

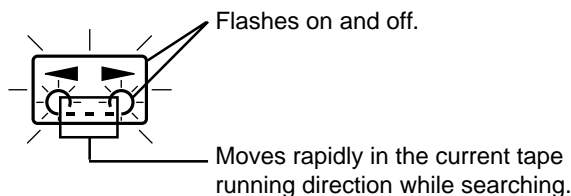

### Notes

- This function may not work for tapes with
  - \* Material with long pauses or quiet passages.
  - \* Low recording levels or excessive noise.
  - \* Pauses of less than 4 seconds between selections.
- If searching is carried out at the first or the last part of a selection, the desired selection may not be found.



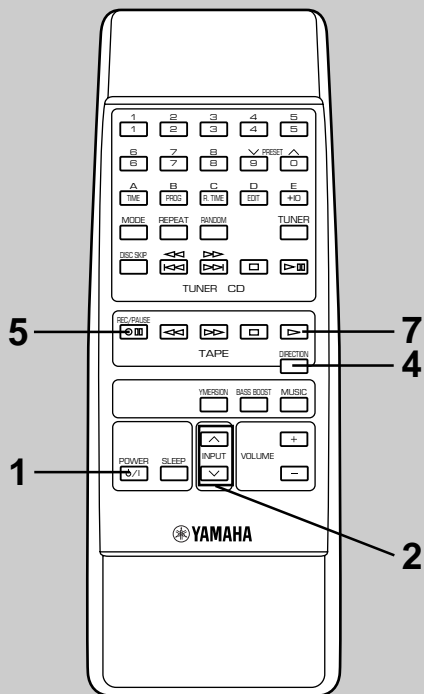
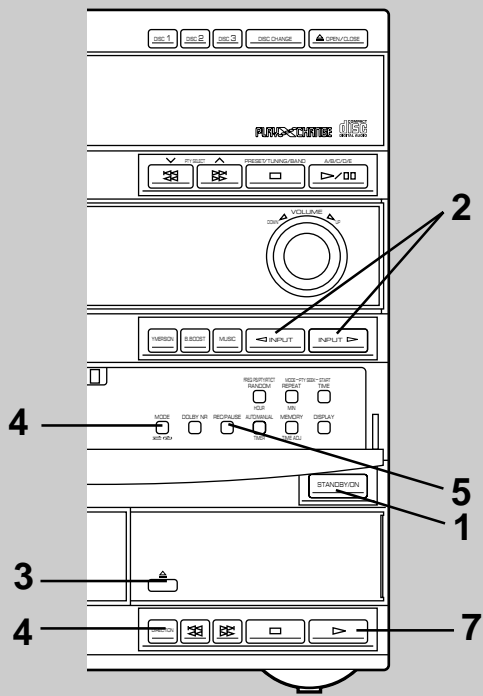

### Notes

- Adjusting the **VOLUME**, **BASS** and **TREBLE** controls, **B. BOOST** and **MUSIC** buttons have no effect on the recorded sound. The recording level is automatically adjusted.
- If you want to make a recording using Dolby NR, press **DOLBY NR** so that “**NR**” (②) lights up on the display. If not, turn “**NR**” (②) off.
  - \* For details, refer to “Dolby B Type Noise Reduction” on page 22.

## Basic recording

- 1 Turn on the power.
- 2 Press **INPUT**  $\triangleright$  or  $\triangleleft$  once or more to select the source you want to record.
- 3 Load a tape on the tray with side A upward.
- 4 Press **DIRECTION** or **MODE** to change the current setting if necessary.

	MODE	
DIRECTION	$\rightleftarrows$	$\rightleftarrows$
	Side A only	Side A → Side B
	Side B only	Side B only

- 5 Press **REC/PAUSE**.
  - \* “TAPE REC” (⑥) lights up on the display.
- 6 Begin playing the source to be recorded.
  - \* When playing a CD, the recording automatically begins a few seconds before the CD play begins. You do not need to follow step 7.
- 7 Press  $\triangleright$  of the tape deck.

### Displaying the tape counter

During recording, the information of the playing source is displayed in place of the tape counter (①). Press **DISPLAY** to change the display to the tape counter. Pressing **DISPLAY** again will restore the previous display mode.



# Recording

## To stop recording temporarily

Press **REC/PAUSE**.

\* Press  $\triangleright / \square$  of the tape deck to resume recording.

## To stop recording

Press  $\square$  of the tape deck.

## To change the disc and track when recording from a CD

**1** Press  $\square$  of the CD player.

\* The recording stops temporarily.

**2** Select the disc by pressing **DISC SKIP** if necessary.

**3** Choose the track you want to record next by using  $\triangleright \triangleright$  or  $\triangleleft \triangleleft$ , and then press  $\triangleright / \square$  of the CD player to resume recording (or simply press the corresponding numeric button(s) on the remote control).

## Notes

- A sequence of tracks in the program play mode and random play mode of the CD player can be recorded in the same way.
- During recording, by simply pressing  $\triangleleft \triangleleft$  or  $\triangleright \triangleright$ , you can rewind the tape to the point where the recording started.

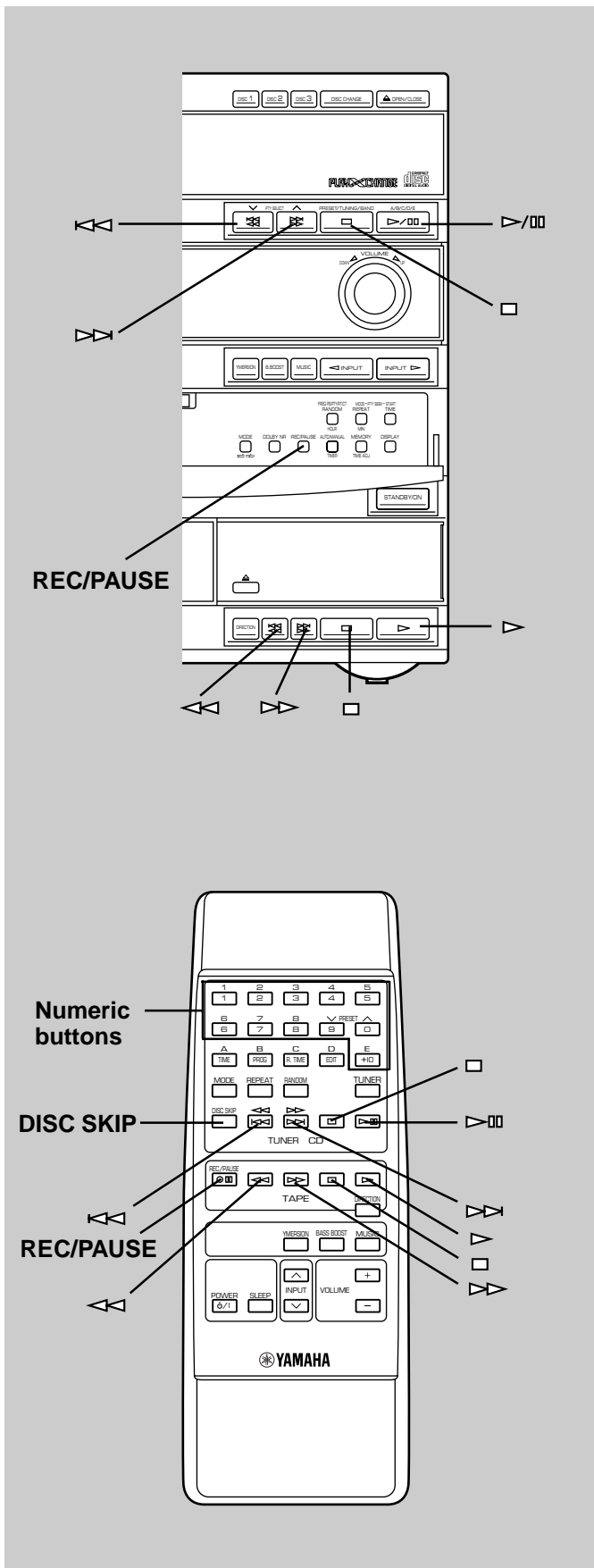



### Recording from CDs utilizing the EDIT function

The EDIT function performs recording on both sides of the tape.

#### EDIT recording

- 1 Press **INPUT**  $\triangleright$  or  $\triangleleft$  once or more until "CD" (①, ⑤) appears on the display, and load the disc to be recorded.
- 2 Select the disc by pressing **DISC SKIP**.
- 3 Load a tape on the tray with side A upward.
- 4 Select "  $\rightleftarrows$  " (④) by pressing **MODE**, and "  $\blacktriangleright$  " (③) by pressing **DIRECTION**.
- 5 Press **R. TIME** on the remote control to select the length of the tape to be used. Whenever pressed, the display changes as shown below.

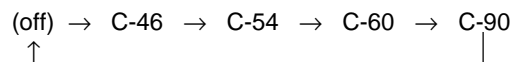

**When using tapes other than C-46, C-54, C-60 or C-90**  
After pressing **R. TIME**, input the tape length by using the numeric buttons on the remote control.

- 6 Press **EDIT**. ("EDIT" (⑧) lights up on the display.)

The following operations are carried out automatically.

- 1) Tracks on the disc are automatically divided into side A and side B. You can check the process by watching the display.
  - \* The tape side indicator (⑨) shows the side currently selected.
- 2) If the tape is not rewound to the end, it will rewind to the end rapidly.
- 3) The end part of the tape on which recording cannot be done is wound.
- 4) Both CD play and recording starts. Recording is carried out on both sides of the tape continuously.

#### Notes

- When the CD player is in the all disc play mode, if the tape's total possible recording time is longer than the total playing time of the selected disc, tracks on another disc are recorded continuously. In this case, as many as three discs can be recorded automatically.
- The CD player's repeat play mode will be canceled during this recording mode.

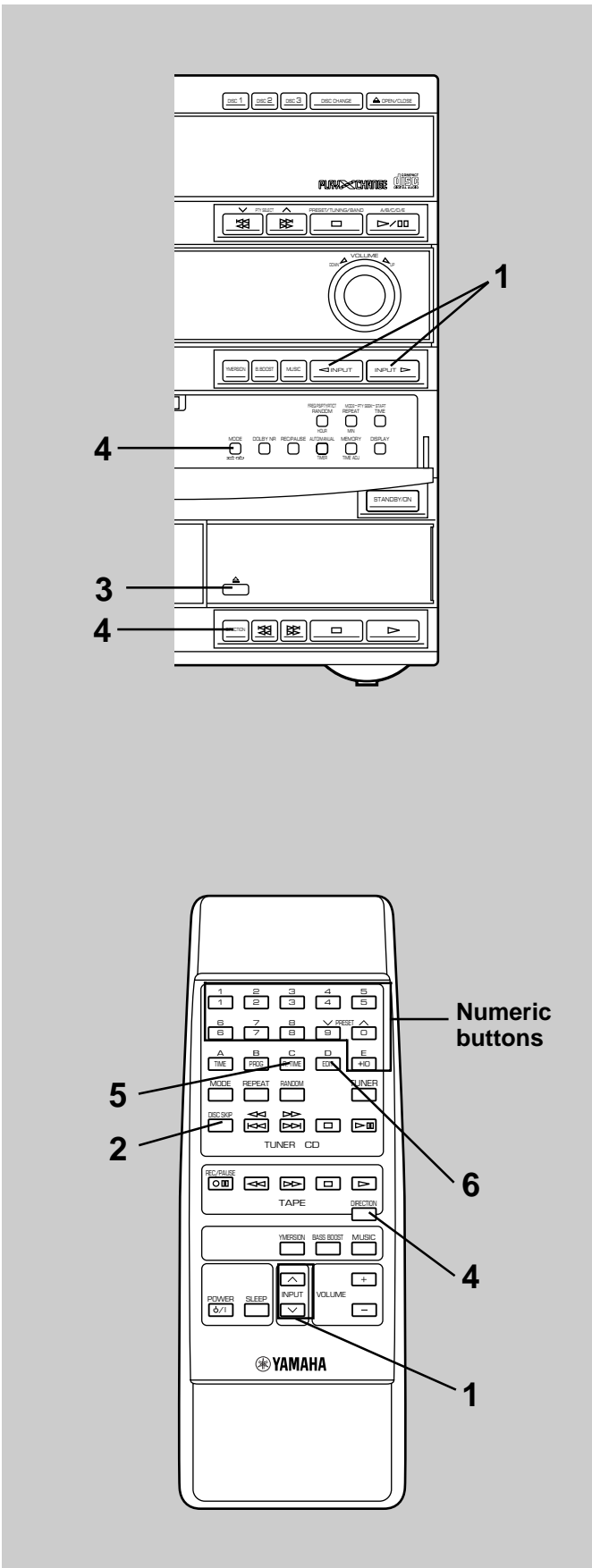



## Recording

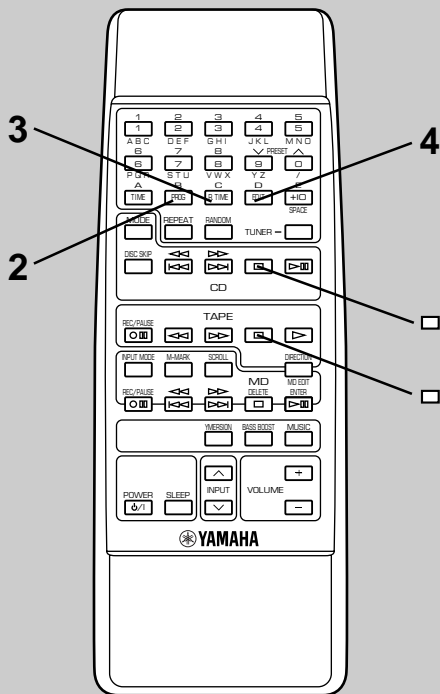
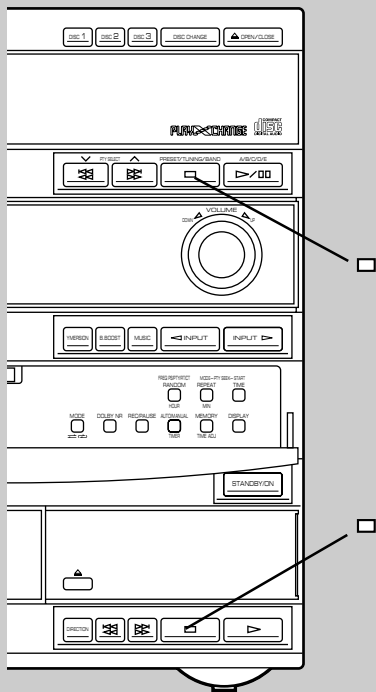

### ■ Auto-EDIT recording

This function automatically changes the order of tracks so that the unrecorded space of side A is minimized.

- 1 Follow steps 1–5 on the previous page.
- 2 Press **PROG**.
- 3 Press **R. TIME**.  
“Auto A >>>” will light up during programming for side A, and “Auto B >>>” will light up during programming for side B.
- 4 Press **EDIT**. (“EDIT” (Ⓢ) lights up on the display.)  
The recording starts.

#### To cancel the EDIT function

Before recording, press □ of the CD player or the tape deck.

#### To stop recording

Press □ of the tape deck.

(At this time, CD play automatically stops.)

## Manual EDIT recording

You can program tracks manually while watching the remaining time on both sides of the tape.

- 1** Press **INPUT**  $\triangleright$  or  $\triangleleft$  once or more until “CD” (①, ⑤) appears on the display, and load a disc (or discs) on the disc tray.
- 2** Follow steps 3–5 on page 27.
- 3** Press **PROG**.
  - \* “PROG” and “P-01” will light up on the display, and all track numbers on the selected disc will begin flashing.
- 4** If necessary, select the desired disc by pressing **DISC SKIP**.
- 5** Select the desired track number by pressing the numeric buttons.
- 6** Repeat steps 4 and 5 to program more selections for side A of the tape. You can select the same track again.
  - \* Pressing **TIME** displays the total remaining time on side A of the tape for about 1 second, and then it is replaced by the display of the next play order.
  - \* If “TM OVER” appears on the display, the track number just selected cannot be programmed because there is not enough time remaining on side A of the tape. However, at this time, if any other track number is flashing continuously on the display, you can program it instead of the unprogrammable one.
- 7** When the programming for side A is finished, press **R. TIME**.
  - \* “Side-B” appears on the display. You can begin programming for side B.
  - \* After following this step, you can check the programmed contents for side A and side B alternately by pressing **R. TIME** at any time before you press **EDIT** in step 9.
  - \* The tape side indicator (⑨) shows the programming side currently selected.
- 8** Repeat steps 4 and 5 to program selections for side B of the tape. You can select the same track again.
- 9** Press **EDIT**. (“EDIT” (⑧) lights up on the display.) The recording starts.

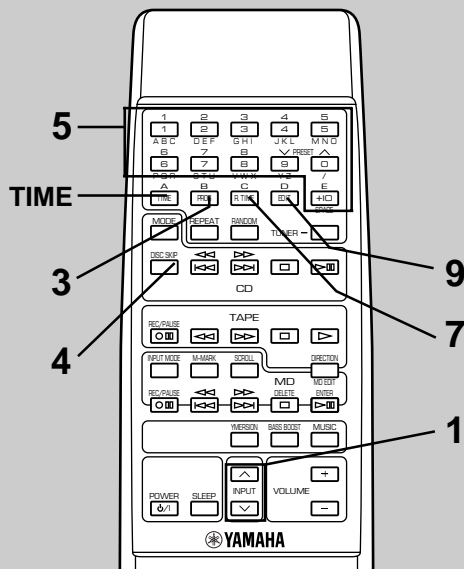
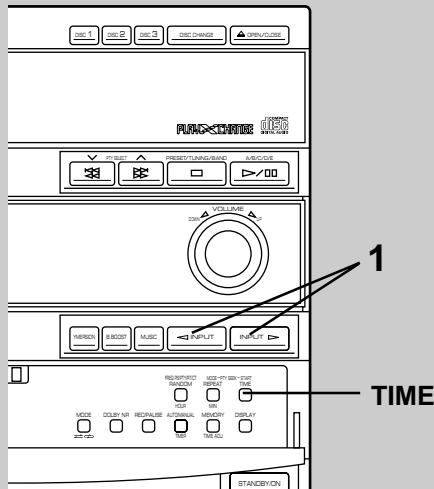

### Display information during programming

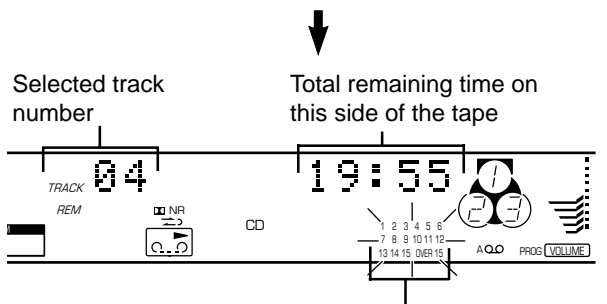
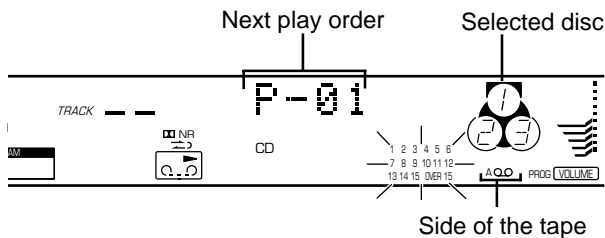

Programmed track numbers light up and only programmable track numbers among unprogrammed ones flash.

### Notes on recording with the EDIT function

- To check, cancel or correct program data, refer to page 11.
- The maximum number of tracks that can be programmed is 20.
- The track number 16 or higher cannot be programmed by this function.

# Operating the external unit connected with this system

Use the external unit connected to the AUX/MD terminals on the rear of the main unit.

## ■ To listen to a source played on the external unit connected with this system

- 1 Press **INPUT**  $\triangleright$  or  $\triangleleft$  until "AUX/MD" appears on the display.
- 2 Play the source.
- 3 Adjust the volume to the desired level by using **VOLUME**.
  - \* If you prefer, you can control the sound quality by using the built-in graphic equalizer (**MUSIC**), **BASS**, **TREBLE**, **B. BOOST** and/or **YMERSSION**. (Refer to pages 31–32 for details.)

## ■ To record a source played on this system by using the MD recorder, tape deck etc. connected to this system

If an MD recorder, tape deck (DAT), etc. is connected to the AUX/MD terminals on the rear of the main unit, you can record a source played on the built-in CD player, tape deck or a radio program by the MD recorder, tape deck (DAT), etc.

- 1 Select the source (CD, TAPE or TUNER) you want to record by using **INPUT**  $\triangleright$  or  $\triangleleft$ .
- 2 Play the source and then turn **VOLUME** up to confirm the input source.
- 3 Begin recording on the MD recorder, tape deck (DAT), etc.

### Note

A digital-to-digital recording is possible from a CD played on the built-in CD player to an MD (or tape) on the MD recorder (or DAT) by connecting the DIGITAL OUT (OPTICAL) terminal on the rear of the main unit to the MD recorder (or DAT).

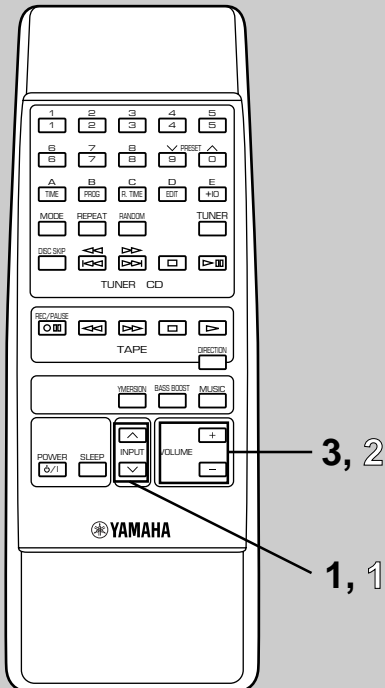
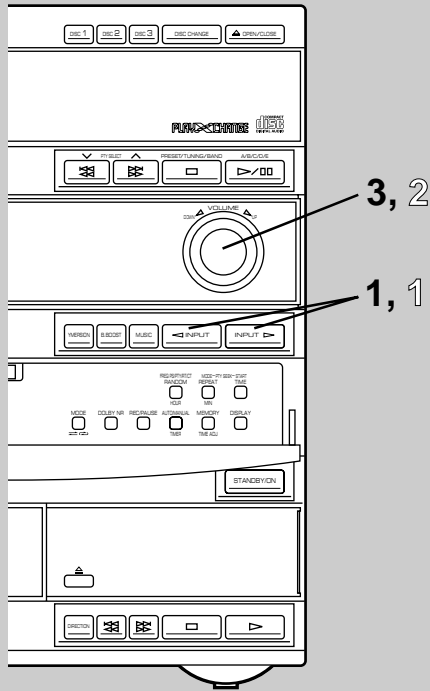

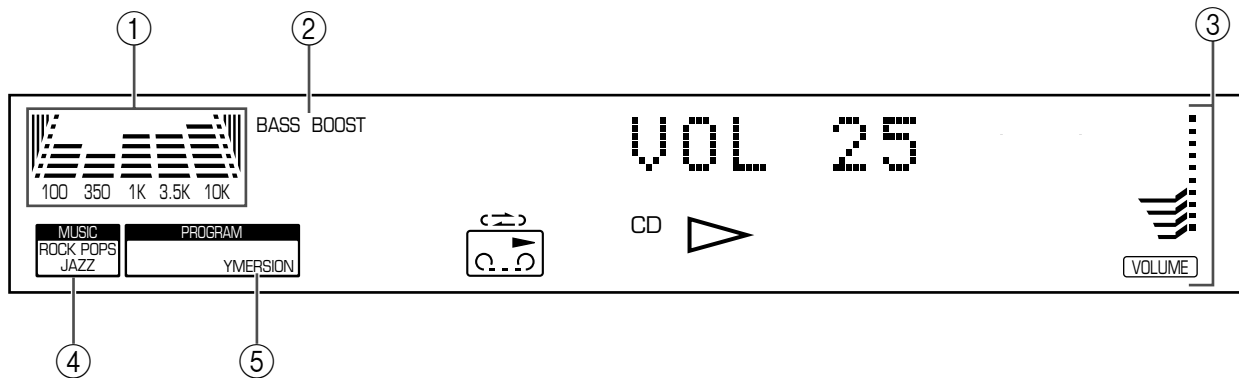

**① Spectrum analyzer**

The spectrum of the input source which is divided in five bands will be indicated in real time.

**② BASS BOOST**

**③ VOLUME (volume level meter)**

**④ MUSIC (preset equalizer mode indicator)**

**⑤ YMERSON**

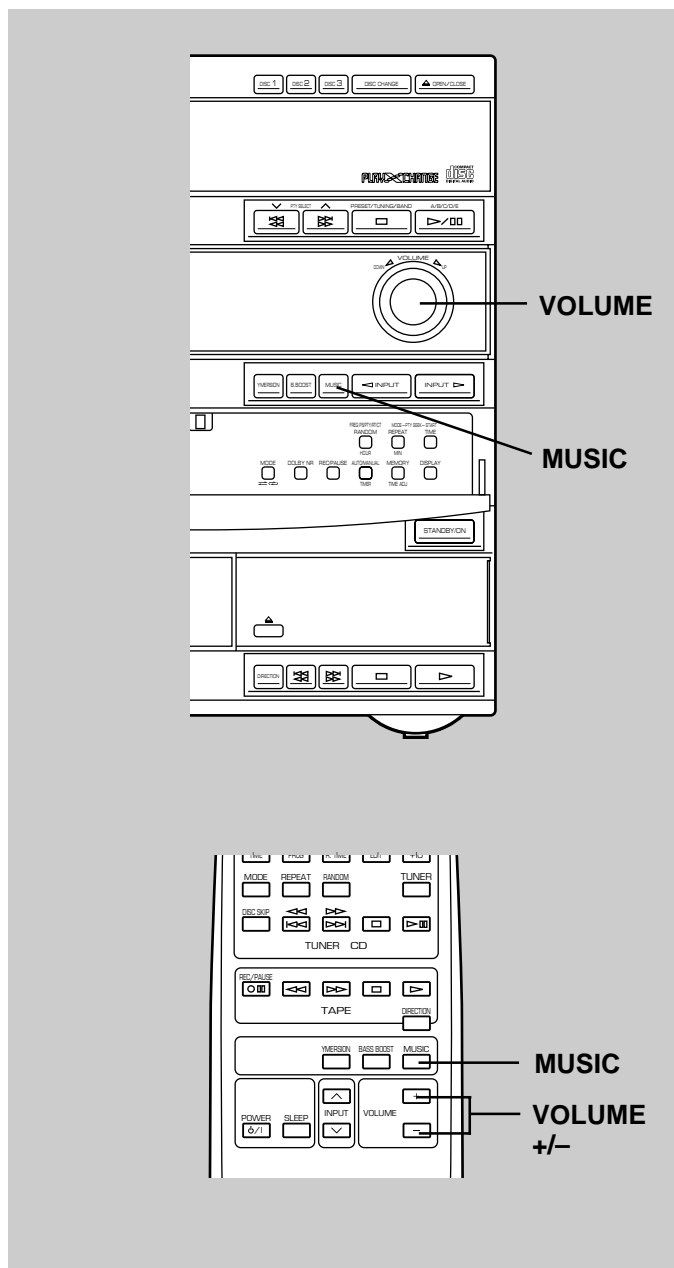

**■ VOLUME control**

**Front panel operation**

Rotate **VOLUME** in the “UP” direction to increase the volume, and the “DOWN” direction to decrease the volume.

**Remote control operation**

Press **VOLUME +** to increase the volume and **VOLUME -** to decrease the volume.

\* Adjusted volume level is shown by the volume level meter (③) and in figures on the display.

**■ Graphic equalizer**

The built-in graphic equalizer provides 3 preset equalizer modes as listed below.

**Preset graphic equalizer modes**

Mode	Feature
<b>ROCK</b>	High and low frequencies are emphasized. This mode is suitable for reproducing dynamic and powerful sounds of rock music, etc.
<b>POPS</b>	Vocals are emphasized and whole sound is clear. This mode is suitable for pops.
<b>JAZZ</b>	High frequencies for piano, sax, etc. are emphasized. Medium frequencies for vocals are also emphasized moderately.

**Listening to the music with a preset equalizer effect**

- 1 Play back a source.
- 2 Press **MUSIC** once or more so that the name of the desired mode lights up on the preset equalizer mode indicator (MUSIC) (④).

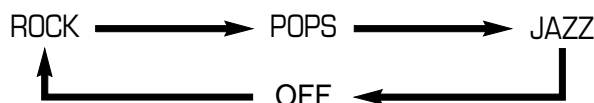

## Various sound control

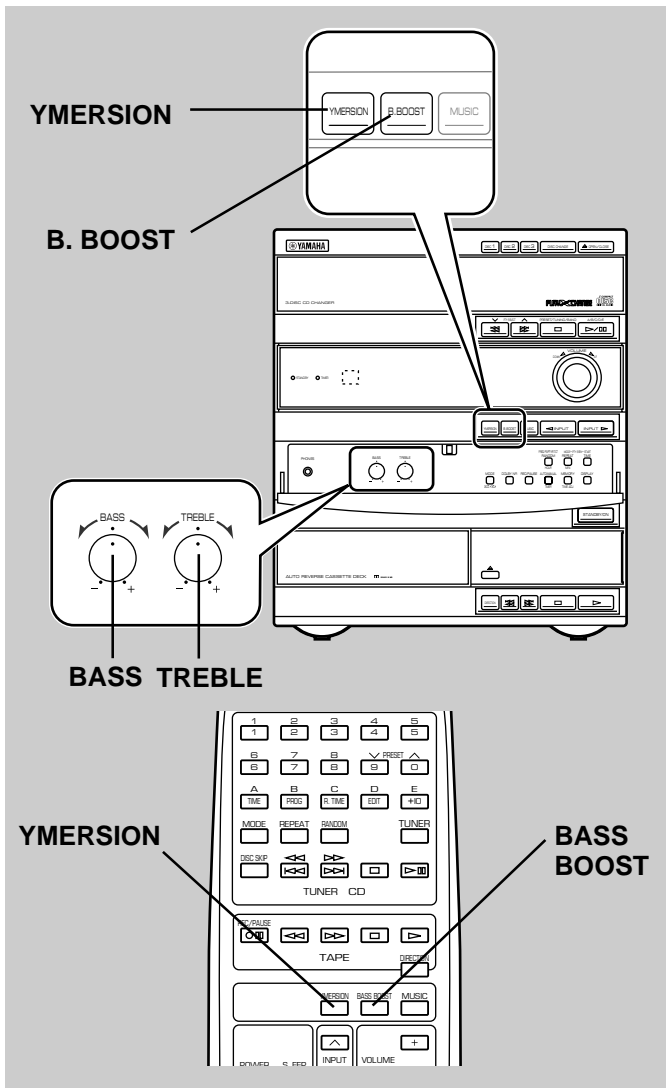

### ■ B. (BASS) BOOST button

Press this button so that “BASS BOOST” (②) is illuminated on the display to boost the bass frequency response at the left and right channels while maintaining overall tonal balance. This function is effective for reinforcing the bass frequencies when a subwoofer is not used.

### ■ BASS and TREBLE controls

**BASS :** Turn this knob clockwise to increase (or counterclockwise to decrease) the low frequency response.

**TREBLE :** Turn this knob clockwise to increase (or counterclockwise to decrease) the high frequency response.

### ■ YMERSION button

Press this button so that “YMERSION” (⑤) is illuminated on the display. YMERSION is Yamaha’s proprietary technology that enhances the spread of a normal stereo source play sound, creating three-dimensional acoustics using only two speakers. Press this button again so that “YMERSION” (⑤) goes out from the display to cancel this sound effect.

### ■ Listening with headphones

- Be sure that your headphones have a 3.5 mm (1/8”) diameter plug and between 16 ohms and 50 ohms impedance. Recommended impedance is 32 ohms.
- When you listen with headphones, connect the headphones to the **PHONES** jack. You can listen to the sound that is normally output from the speakers through headphones. Adjust **VOLUME** to a comfortable listening level.

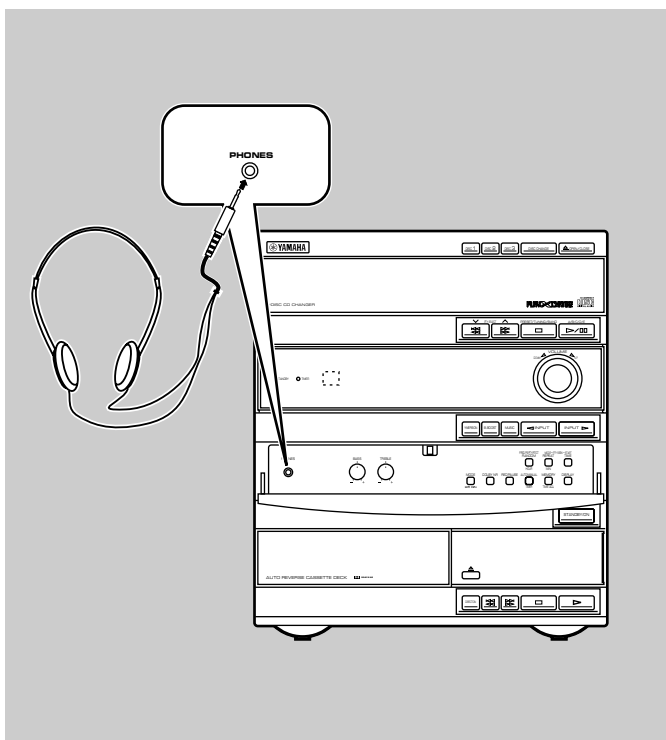



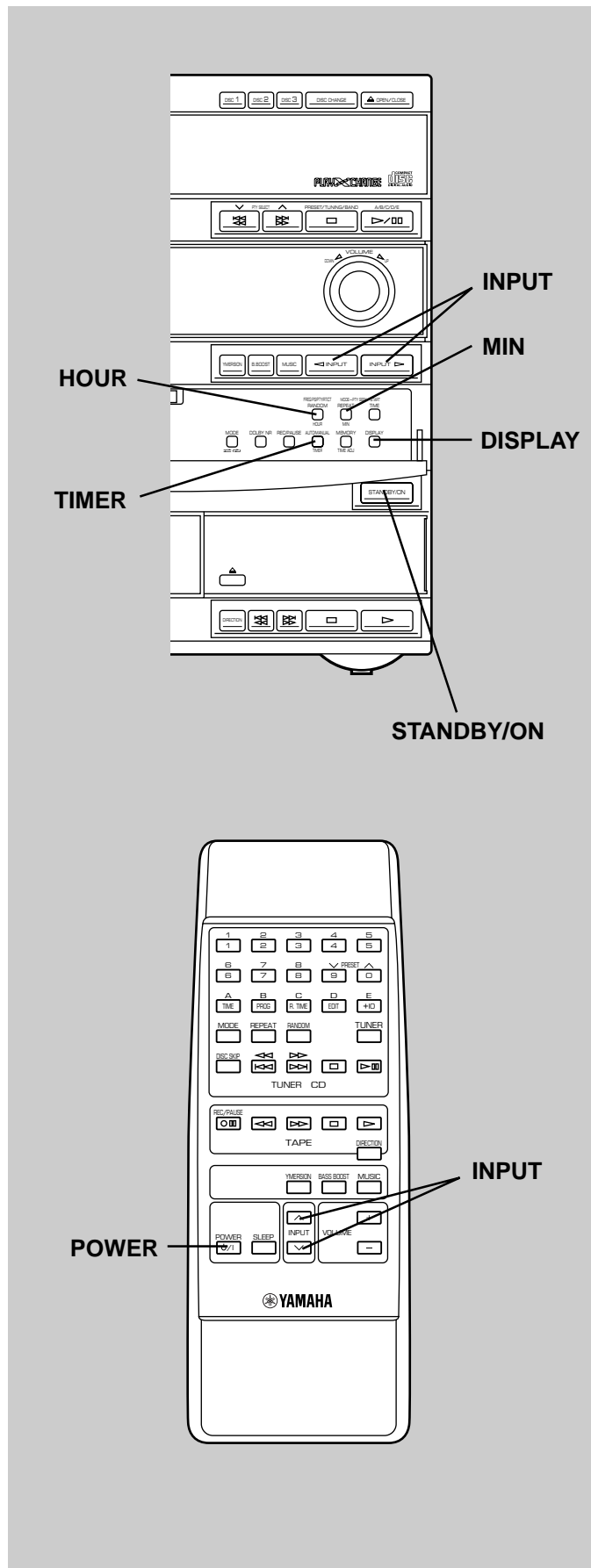

## Timer play

By using the built-in timer, you can set the time when this system turns on and a source play begins, and the time when this system will be set to the standby mode automatically.

**1** Press **DISPLAY**.  
Whenever **DISPLAY** is pressed, the display mode changes as follows.

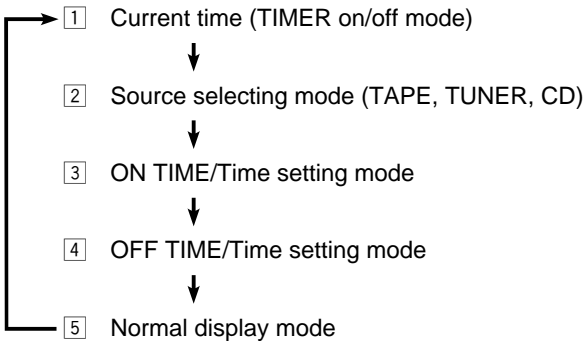

**Note**  
The display mode will change in about 8 seconds. If the mode is changed before the setting is completed, call the mode again by pressing **DISPLAY** once or more.

**1** **Current time**  
Make sure that the current time is correct, and press **TIMER** so that "TIMER" lights up on the display.

**2** **Source selecting mode**  
Select the source to be played with **INPUT**  $\triangleright$  or  $\triangleleft$ .

**3** **ON TIME/time setting mode**  
["ON TIME" appears on the display, and soon it is changed to a time setting mode.]  
Set the time when you want to begin the timer play.  
● Press **HOUR** and set the hour.  
● Press **MIN** and set the minute.

**4** **OFF TIME/time setting mode**  
If necessary, set the time when you want to finish the timer play in the same way as you did in step **3**. If you do not set the time, it will be automatically set so that the timer play finishes after 1 hour.

**2** Press **TIMER** to complete the timer play setting.  
This system turns into the standby mode.  
\* The **STANDBY** and **TIMER** indicators light up.

If you will continue using this system, press **STANDBY/ON** to turn on this system.

**To cancel the timer play setting**  
Press **DISPLAY**, and then press **TIMER** so that the **TIMER** indicator goes out.

**Note**  
Unless there is a power failure for more than 5 minutes, the set time will be retained until it is reset.

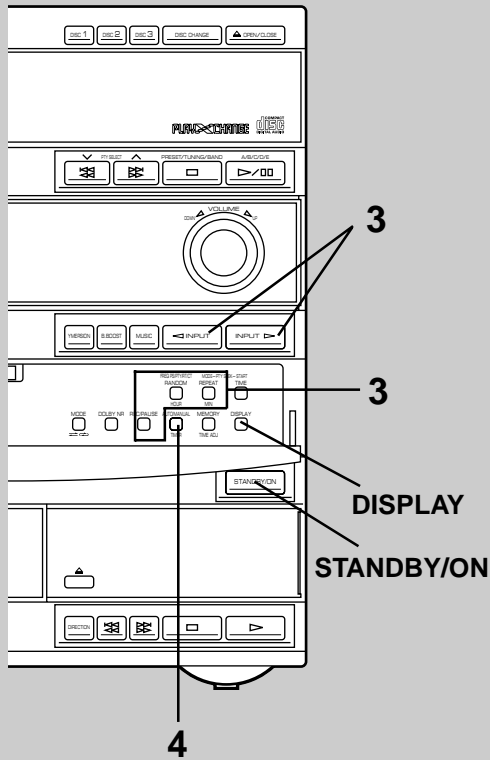

## Timer recording

- 1 Follow steps 2–3 of “Basic recording” on page 25.
- 2 Tune in to the station you want to record.
- 3 Follow step 1 of “Timer play” on page 33.
  - \* In step 2, select “TUNER”, and then press **REC/ PAUSE**. (“REC >TAPE” and the frequency will flash alternately on the display.)
  - \* In step 3, set the time when you want to begin recording.
  - \* In step 4, set the time when you want to finish recording.
- 4 Press **TIMER**.  
This system will be set to the standby mode.
  - \* The **STANDBY** and **TIMER** indicators light up.

### To cancel the setting of timer recording

Press **DISPLAY** once or more so that “REC >TAPE” flashes on the display. While “REC >TAPE” is flashing, press **REC/ PAUSE**.

### Note

When the timer recording is finished, the timer setting is automatically canceled.

## Sleep timer operation

This system will be set to the standby mode automatically when the selected sleep time passes.

- 1 Play the desired sound source.
- 2 Press **SLEEP** repeatedly until the desired sleep time appears on the display. The display will change as described below.

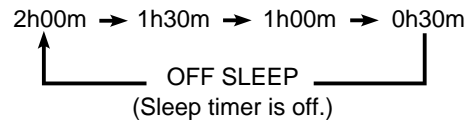

- \* The normal display mode will resume about 4 seconds after the selection is made.
- \* “SLEEP” will light up on the display.

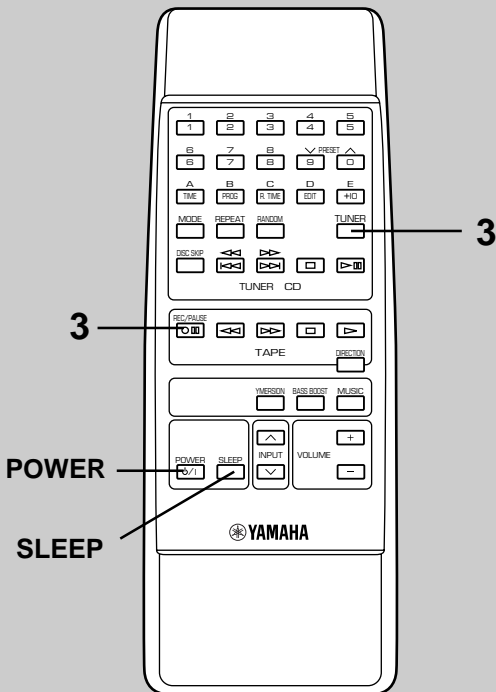

## Troubleshooting

Refer to the chart below when this system does not function properly. If the problem you are experiencing is not listed below or if the instruction below does not help, disconnect the power cord and contact your authorized YAMAHA dealer or service center.

	Problem	Cause	What to Do
General	This system does not work normally.	There is an influence of strong external noise (lightning, excessive static electricity, etc.) or the system was operated incorrectly.	Set this system to the standby mode and disconnect the AC power cord from the AC outlet. After about 30 seconds pass, connect the power and operate this system again.
	The sound suddenly goes off.	The protection circuit was activated because of a short circuit, etc.	Set this system to the standby mode, then turn on to reset the protection circuit.
		The SLEEP timer was activated.	Cancel the SLEEP timer function.
	No sound from speakers.	Speaker connections are not secure.	Secure the connections.
	No sound from the external unit connected with this system.	Incorrect cord connections.	Connect the cords properly. If the problem persists, the cords may be defective.
		Input source selection is not correct.	Make a correct input source selection.
	Timer cannot be set.	Current time is not set.	Set current time.
This system will not operate properly.	The internal microcomputer has been frozen by an external electric shock (lightning, excessive static electricity, etc.) or power supply with low voltage.	Unplug the AC supply lead from the wall AC outlet, then plug in again after about one minute.	
The volume level cannot be increased, or sound is distorted.	The component connected to the AUX/MD terminals on the rear of the main unit is turned off.	Turn on the power to the component.	
Tuner	Excessive static in FM broadcasts.	Interference from starting motor of nearby car.	Position the FM antenna as high and as far away from nearby roads as possible. Use coaxial cable.
		Interference from thermostat of nearby electrical appliance.	
	Noise increases during stereo broadcasts.	Antenna input is too weak due to obstructions or excessive distance from broadcasting station.	Check antenna connections.
			Install a multi-element type FM antenna if possible.
	Stereo broadcasts are noisy and STEREO indicator blinks on and off.	Insufficient antenna input.	Install an antenna appropriate for the electric field strength of your area.
	Preset stations cannot be selected.	Preset memory has been erased.	Reprogram memory presets.
	Buzzing or static during AM broadcasts.	Interference from source such as lightning, fluorescent lights, electric motors or thermostat of nearby electrical appliance.	Problem is difficult to eliminate but can be lessened by grounding AM loop antenna.
TV or microprocessor is being used nearby.		Move away from TV or microprocessor.	
AM broadcast sensitivity is poor.	Radio signal is weak or antenna is not properly connected.	Properly connect AM loop antenna.	
		Change orientation of AM loop antenna.	
		Install an external AM antenna.	

## Appendix

	Problem	Cause	What to Do
CD player	A disc cannot be played back normally, or there is a noise during play.	The disc is not a standard type.	Play another disc.
	Play will not begin even if disc is loaded.	Disc is upside down.	Load disc label side facing up.
		Disc is dirty.	Clean disc.
	No sound.	The input source selection is incorrect.	Select the CD player by pressing INPUT ◀ or ▶ button until "CD" is illuminated on the display.
Sound stops suddenly (always at the same spot).	Disc is dirty.	Clean disc.	
	Volume is set too high.	Lower volume.	
Tape deck	Tape will not move during playback or recording.	Slack tape wrapped around pinch roller.	Take up slack with a pencil before using.
	Recording is not possible.	Erasure prevention tab is broken off.	Replace tape or cover erasure prevention hole with cellophane tape.
		Head is dirty.	Clean heads.
	Sound is distorted or fades out, or stereo balance is poor.	Head is dirty.	Clean heads.
		Tape is worn.	Replace tape.
	Poor sound quality.	Tape encoded with Dolby NR is played back with this system's Dolby NR off.	Press the DOLBY NR button to turn it on.
		Tape not encoded with Dolby NR is played back with this system's Dolby NR on.	Press the DOLBY NR button to turn it off.
	Excessive noise.	Head has become magnetized.	Demagnetize heads with head eraser.
	Tape travel stops in middle of playback or recording.	Slack tape coming out of cassette shell.	Take up slack by turning reels with a pencil.
		Tape is creased or torn.	Replace with new tape.
		Endless tape is being used.	Do not use endless tapes.
The beginning of desired selections on tape cannot be found.	Silent gaps between selections are too short.	The function of searching for the beginning of desired selections will not operate unless the silent gaps between selections are at least four seconds long.	
	Excessively soft passages in middle of selections.		
	Conversation, etc. is recorded.		
Remote control	Remote control does not work.	Batteries are dead.	Replace batteries.
		Remote control is too far away or tilted too much.	Use within 6 m and 60° radius.
		Direct sunlight or lighting (of an inverter type of fluorescent lamp, etc.) is striking the remote control sensor of the main unit.	Change position of the main unit.
	TV functions strangely when the remote control is used.	Remote control is being used near TV set with a remote control sensor.	Relocate the main unit away from the TV or cover TV's remote control sensor.

## Specifications

### ■ Amplifier section

<b>Minimum RMS Output Power per Channel</b>	
6 ohm, 1 kHz, 0.9% THD .....	80W+80W
<b>Input Sensitivity/Impedance</b>	
AUX/MD .....	200 mV/47 k-ohm
<b>Spectrum Analyzer Band</b> .....	5 bands
(100 Hz, 350 Hz, 1 kHz, 3.5 kHz, 10 kHz)	

### ■ Tuner section

<b>Tuning Range</b>	
FM .....	87.50 to 108.00 MHz
AM .....	531 to 1,611 kHz
<b>Usable Sensitivity (FM)</b>	
75 ohm, DIN, Mono, S/N 26 dB .....	1.8 $\mu$ V
S/N 30 dB, 1 kHz, 100% Mod. ....	1.5 $\mu$ V

### ■ CD player section

<b>Type</b> .....	3 disc carousel auto-changer
<b>D/A Converter</b> .....	1-bit DAC
<b>Filter</b> .....	8-time oversampling digital filter

### ■ Tape deck section

<b>Type</b> .....	Auto reverse stereo cassette deck
<b>Frequency Response (-20 dB)</b>	
Type 1 (Normal) .....	50 to 15,000 Hz
Type 2 (High) .....	50 to 16,000 Hz
<b>Wow and Flutter</b> .....	0.09%, W.RMS
<b>Signal-to-Noise Ratio</b> .....	58 dB (Dolby NR OFF)
	66 dB (Dolby B NR ON)
<b>Harmonic Distortion</b> .....	0.8%

### ■ Speaker section

<b>Type</b> .....	3-way bass reflex: 13 cm woofer
	5 cm tweeter
	2 cm super tweeter
	Magnetic shielding type
<b>Maximum Input</b> .....	240 W
<b>Impedance</b> .....	6 ohm

### ■ General

<b>Power Supply</b> .....	AC 230V, 50 Hz
<b>Power consumption</b> .....	140 W
<b>Dimensions (W x H x D)</b>	
Main unit .....	280 x 320 x 364 mm
Speaker .....	200 x 320 x 218 mm
<b>Weight</b>	
Main unit .....	10.5 kg
Speaker .....	3.8 kg x 2
<b>Accessories</b> .....	Remote control
	Batteries
	Speaker cords
	AM loop antenna
	Indoor FM antenna

Specifications are subject to change without notice.



---

YAMAHA ELECTRONICS CORPORATION, USA 6660 ORANGETHORPE AVE., BUENA PARK, CALIF. 90620, U.S.A.  
YAMAHA CANADA MUSIC LTD. 135 MILNER AVE., SCARBOROUGH, ONTARIO M1S 3R1, CANADA  
YAMAHA ELECTRONIK EUROPA G.m.b.H. SIEMENSSTR. 22-34, 25462 RELINGEN BEI HAMBURG, F.R. OF GERMANY  
YAMAHA ELECTRONIQUE FRANCE S.A. RUE AMBROISE CROIZAT BP70 CROISSY-BEAUBOURG 77312 MARNE-LA-VALLEE CEDEX02, FRANCE  
YAMAHA ELECTRONICS (UK) LTD. YAMAHA HOUSE, 200 RICKMANSWORTH ROAD WATFORD, HERTS WD1 7JS, ENGLAND  
YAMAHA SCANDINAVIA A.B. J A WETTERGRENS GATA 1, BOX 30053, 400 43 VÄSTRA FRÖLUNDA, SWEDEN  
YAMAHA MUSIC AUSTRALIA PTY, LTD. 17-33 MARKET ST., SOUTH MELBOURNE, 3205 VIC., AUSTRALIA

YAMAHA CORPORATION  
Printed in Malaysia 🇲🇾 V371270