

YAMAHA

ELECTRONIC PIANO

P-150

OWNER'S MANUAL

# SPECIAL MESSAGE SECTION

**PRODUCT SAFETY MARKINGS:** Yamaha electronic products may have either labels similar to the graphics shown below or molded / stamped facsimiles of these graphics on the enclosure. The explanation of these graphics appears on this page.

Please observe all cautions indicated on this page and those indicated in the safety instruction section.

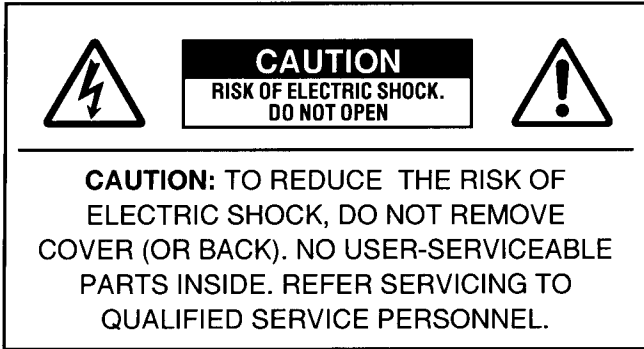

See the name plate for graphic symbol markings.



The exclamation point within the equilateral triangle is intended to alert the user to the presence of important operating and maintenance (servicing) instructions in the literature accompanying the product.

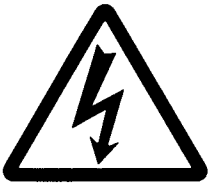

The lightning flash with arrowhead symbol within the equilateral triangle is intended to alert the user to the presence of uninsulated "dangerous voltage" within the product's enclosure that may be of sufficient magnitude to constitute a risk of electrical shock.

**IMPORTANT NOTICE:** All Yamaha electronic products are tested and approved by an independent safety testing laboratory in order that you may be sure that when it is properly installed and used in its normal and customary manner, all foreseeable risks have been eliminated. DO NOT modify this unit or commission others to do so unless specifically authorized by Yamaha.

Product performance and/or safety standards may be diminished. Claims filed under the expressed warranty may be denied if the unit is/has been modified. Implied warranties may also be affected.

**SPECIFICATIONS SUBJECT TO CHANGE:** The information contained in this manual is believed to be correct at the time of printing. However, Yamaha reserves the right to change or modify any of the specifications without notice or obligation to update existing units.

**ENVIRONMENTAL ISSUES:** Yamaha strives to produce products that are both user safe and environmentally friendly.

We sincerely believe that our products and the production methods used to produce them, meet these goals. In keeping with both the letter and the spirit of the law, we want you to be aware of the following:

**BATTERY NOTICE:** This product MAY contain a small nonrechargeable battery which (if applicable) is soldered in place. The average life span of this type of battery is approximately five years. When replacement becomes necessary, contact a qualified service representative to perform the replacement.

**WARNING:** Do not attempt to recharge, disassemble, or incinerate this type of battery. Keep all batteries away from children. Dispose of used batteries promptly and as regulated by applicable laws. Note: In some areas, the servicer is required by law to return the defective parts. However, you do have the option of having the servicer dispose of these parts for you.

**DISPOSAL NOTICE:** Should this product become damaged beyond repair, or for some reason its useful life is considered to be at an end, please observe all local, state, and federal regulations that relate to the disposal of products that contain lead, batteries, plastics, etc.

**NOTICE:** Service charges incurred due to lack of knowledge relating to how a function or effect works (when the unit is operating as designed) are not covered by the manufacturer's warranty, and are therefore the owner's responsibility. Please study this manual carefully and consult your dealer before requesting service.

**NAME PLATE LOCATION:** The graphic below indicates the location of the name plate. The model number, serial number, power requirements, etc., are located on this plate. You should record the model number, serial number, and the date of purchase in the spaces provided below and retain this manual as a permanent record of your purchase.

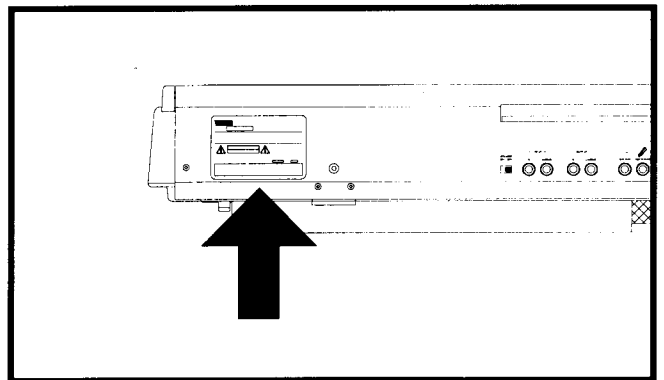

Model \_\_\_\_\_

Serial No. \_\_\_\_\_

Purchase Date \_\_\_\_\_

## FCC INFORMATION (U.S.A)

### 1. IMPORTANT NOTICE: DO NOT MODIFY THIS UNIT!

This product, when installed as indicated in the instructions contained in this manual, meets FCC requirements. Modifications not expressly approved by Yamaha may void your authority, granted by the FCC, to use the product.

**2. IMPORTANT:** When connecting this product to accessories and/or another product use only high quality shielded cables.

Cable/s supplied with this product MUST be used. Follow all installation instructions. Failure to follow instructions could void your FCC authorization to use this product in the USA.

**3. NOTE:** This product has been tested and found to comply with the requirements listed in FCC Regulations, Part 15 for Class "B" digital devices. Compliance with these requirements provides a reasonable level of assurance that your use of this product in a residential environment will not result in harmful interference with other electronic devices. This equipment generates/uses radio frequencies and, if not installed and used according to the instructions found in the user's manual, may cause interference harmful to the operation of other electronic devices. Compliance with FCC regulations does not guarantee that interference will not occur in all installations. If this product is found to be the source of interference, which can be determined by turning the unit "OFF" and "ON", please try to eliminate the problem by using one of the following measures:

Relocate either this product or the device that is being affected by the interference.

Utilize power outlets that are on different branch (circuit breaker or fuse) circuits or install AC line filter/s.

In the case of radio or TV interference, relocate/reorient the antenna.

If the antenna lead-in is 300 ohm ribbon lead, change the lead-in to co-axial type cable.

If these corrective measures do not produce satisfactory results, please contact the your local retailer authorized to distribute this type of product.

If you can not locate the appropriate retailer, please contact Yamaha Corporation of America, Electronic Service Division, 6600 Orangethorpe Ave, Buena Park, CA 90620.

The above statements apply ONLY to those products distributed by Yamaha Corporation of America or its subsidiaries.

## CANADA

THIS DIGITAL APPARATUS DOES NOT EXCEED THE "CLASS B" LIMITS FOR RADIO NOISE EMISSIONS FROM DIGITAL APPARATUS SET OUT IN THE RADIO INTERFERENCE REGULATION OF THE CANADIAN DEPARTMENT OF COMMUNICATIONS.

LE PRESENT APPAREIL NUMERIQUE N'EMET PAS DE BRUITS RADIOELECTRIQUES DEPASSANT LES LIMITES APPLICABLES AUX APPAREILS NUMERIQUES DE LA "CLASSE B" PRESCRITES DANS LE REGLEMENT SUR LE BROUILLAGE RADIOELECTRIQUE EDICTE PAR LE MINISTERE DES COMMUNICATIONS DU CANADA.

**CAUTION:** TO PREVENT ELECTRIC SHOCK, MATCH WIDE BLADE OF PLUG TO WIDE SLOT, FULLY INSERT.

**ATTENTION:** POUR ÉVITER LES CHOCS ÉLECTRIQUES, INTRODUIRE LA LAME LA PLUS LARGE DE LA FICHE DANS LA BORNE CORRESPONDANTE DE LA PRISE ET POUSSER JUSQU'AU FOND.

- This applies only to products distributed by Yamaha Canada Music LTD.
- Ceci ne s'applique qu'aux produits distribués par Yamaha Canada Music LTD.

### Litiumbatteri!

Bör endast bytas av servicepersonal.  
Explosionsfara vid felaktig hantering.

### VAROITUS!

Lithiumparisto, Räjähdyksvaara.  
Pariston saa vaihtaa ainoastaan alan ammattimies.

### ADVARSELI

Lithiumbatteri!  
Eksplønsjonsfare. Udskiftning må kun foretages af en sagkyndig, - og som beskrevet i servicemanualen.

## IMPORTANT NOTICE FOR THE UNITED KINGDOM

Connecting the plug and Cord  
IMPORTANT: THE WIRES IN MAINS LEAD ARE COLOURED IN ACCORDANCE WITH THE FOLLOWING CODE:

**BLUE : NEUTRAL**  
**BROWN : LIVE**

As the colours of the wires in the mains lead of this apparatus may not correspond with the coloured markings identifying the terminals in your plug, proceed as follows:

The wire which is coloured BLUE must be connected to the terminal which is marked with the letter N or coloured BLACK.

The wire which is coloured BROWN must be connected to the terminal which is marked with the letter L or coloured RED.

Making sure that neither core is connected to the earth terminal of the three pin plug.

# IMPORTANT SAFETY INSTRUCTIONS

INFORMATION RELATING TO PERSONAL INJURY, ELECTRICAL SHOCK, AND FIRE HAZARD  
POSSIBILITIES HAS BEEN INCLUDED IN THIS LIST.

**WARNING-** When using any electrical or electronic product, basic precautions should always be followed. These precautions include, but are not limited to, the following:

**1.** Read all Safety Instructions, Installation Instructions, Special Message Section items, and any Assembly Instructions found in this manual BEFORE making any connections, including connections to the main supply.

**2.** Main Power Supply Verification: Yamaha products are manufactured specifically for the supply voltage in the area where they are to be sold. If you should move, or if any doubt exists about the supply voltage in your area, please contact your dealer for supply voltage verification and (if applicable) instructions. The required supply voltage is printed on the name plate. For name plate location, please refer to the graphic found in the Special Message Section of this manual.

**3.** This product may be equipped with a polarized plug (one blade wider than the other). If you are unable to insert the plug into the outlet, turn the plug over and try again. If the problem persists, contact an electrician to have the obsolete outlet replaced. DO NOT defeat the safety purpose of the plug.

**4.** Some electronic products utilize external power supplies or adapters. DO NOT connect this type of product to any power supply or adapter other than one described in the owners manual, on the name plate, or specifically recommended by Yamaha.

**5. WARNING:** Do not place this product or any other objects on the power cord or place it in a position where anyone could walk on, trip over, or roll anything over power or connecting cords of any kind. The use of an extension cord is not recommended! IF you must use an extension cord, the minimum wire size for a 25' cord (or less) is 18 AWG. NOTE: The smaller the AWG number, the larger the current handling capacity. For longer extension cords, consult a local electrician.

**6.** Ventilation: Electronic products, unless specifically designed for enclosed installations, should be placed in locations that do not interfere with proper ventilation. If instructions for enclosed installations are not provided, it must be assumed that unobstructed ventilation is required.

**7.** Temperature considerations: Electronic products should be installed in locations that do not significantly contribute to their operating temperature. Placement of this product close to heat sources such as; radiators, heat registers and other devices that produce heat should be avoided.

**8.** This product was NOT designed for use in wet/damp locations and should not be used near water or exposed to rain. Examples of wet /damp locations are; near a swimming pool, spa, tub, sink, or wet basement.

**9.** This product should be used only with the components supplied or; a cart, rack, or stand that is recommended by the manufacturer. If a cart, rack, or stand is used, please observe all safety markings and instructions that accompany the accessory product.

**10.** The power supply cord (plug) should be disconnected from the outlet when electronic products are to be left unused for extended periods of time. Cords should also be disconnected when there is a high probability of lightning and/or electrical storm activity.

**11.** Care should be taken that objects do not fall and liquids are not spilled into the enclosure through any openings that may exist.

**12.** Electrical/electronic products should be serviced by a qualified service person when:

- The power supply cord has been damaged; or
- Objects have fallen, been inserted, or liquids have been spilled into the enclosure through openings; or
- The product has been exposed to rain; or
- The product does not operate, exhibits a marked change in performance; or
- The product has been dropped, or the enclosure of the product has been damaged.

**13.** Do not attempt to service this product beyond that described in the user-maintenance instructions. All other servicing should be referred to qualified service personnel.

**14.** This product, either alone or in combination with an amplifier and headphones or speaker/s, may be capable of producing sound levels that could cause permanent hearing loss. DO NOT operate for a long period of time at a high volume level or at a level that is uncomfortable. If you experience any hearing loss or ringing in the ears, you should consult an audiologist.

**IMPORTANT:** The louder the sound, the shorter the time period before damage occurs.

**15.** Some Yamaha products may have benches and/or accessory mounting fixtures that are either supplied as a part of the product or as optional accessories. Some of these items are designed to be dealer assembled or installed. Please make sure that benches are stable and any optional fixtures (where applicable) are well secured BEFORE using. Benches supplied by Yamaha are designed for seating only. No other uses are recommended.

## PLEASE KEEP THIS MANUAL

# INTRODUCTION

Congratulations! ...and thank you for purchasing the Yamaha P-150. The P-150 is a high-performance electronic piano with full-scale, weighted action keyboard, a selection of high quality piano and other useful instrument voices, and versatile performance and other advanced features which make it ideal for professional stage and studio applications, as well as for home entertainment and music study use. The P-150's main features include:

## ■ High quality AWM piano and other sounds

The P-150 features a selection of twelve high quality instrument voices generated by Yamaha's patented AWM (Advanced Wave Memory) sound generation technology. There are several piano sounds—including a concert grand piano, with full-bodied bass tones and reverberating high notes, that accurately captures the natural characteristics of a real grand piano—plus various electric pianos, vibes, organ combinations, strings and electric and upright bass. With a maximum simultaneous "polyphonic" note output of 32 notes, the P-150 delivers uncompromising performance capabilities.

## ■ Organ combination editing

The P-150 comes equipped with two preset organ voices, plus organ combination editing features which let you create your own organ sounds and store them in Performances for instant recall. The organ combination editing features give you precise control over flute footages as well as attack settings.

## ■ Digital signal processing

The P-150 has a built-in digital signal processor that lets you apply stereo reverb, chorus, symphonic and tremolo effects to the voices, and lets you tailor the quality of the voices to suit your needs with an internal equalizer, as well as a three-band graphic equalizer on the upper panel.

## ■ Touch-sensitive keyboard with velocity scaling

The P-150's full-range 88-key, weighted action piano keyboard incorporates Yamaha's unique Action Effect II keyboard technology, which gives it the genuine feel and response of a real piano keyboard. You can even adjust the keyboard's sensitivity level, or velocity scaling, to suit your playing style, for both internal tone generator and MIDI message transmission.

## ■ Dual and Split voice modes

The P-150's Dual and Split modes let you play two voices at once, a "main" voice and a "sub" voice, either by layering the two voices of your choice (Dual mode) or by assigning a different voice to each end of the keyboard (Split mode). In Split mode, the key transposition values can be set independently for both main and sub voices.

## ■ One-touch Performance recall

The P-150 features a Performance Play mode that lets you store up to 24 Performances, or configurations of all voice, MIDI and other parameter settings, for recall at the touch of a button. This lets you instantly change your sound and entire setup as you play, or between songs in a live set. The P-150 is set at the factory with 24 Preset Performances, but you can overwrite them and store User Performances which you create yourself. The P-150 features extensive editing and storing capabilities.

## ■ Master keyboard features

The P-150 offers many of the control features standard in a MIDI master keyboard, including velocity sensitivity, pitch bend and modulation wheels, an assignable CS (continuous slider), program change send and receive capabilities, MIDI transpose and merge functions, and bulk dumping and multitimbral capabilities. Plus, the P-150 gives you the option of connecting a foot controller (FC) that can be assigned MIDI and other functions in the same manner as the CS. With its powerful MIDI capabilities, the P-150 can easily feature at the heart of an expanded MIDI system.

### How to Use this Manual

This owner's manual is organized and designed to help you get set up and begin enjoying the P-150 as quickly as possible, as well as to easily locate and learn about any feature you need. The GETTING STARTED section briefly but thoroughly explains the proper procedure for setting up the instrument, listening to the on-board Demo songs, and exploring the basic voices. The VOICE PLAY MODE, PERFORMANCE PLAY MODE and EDIT MODE sections include explanations of each feature and step-by-step details about how to access and manipulate the many parameters. An APPENDIX provides Voice and Performance lists and other technical information, including descriptions of error messages and a troubleshooting guide, plus MIDI specifications and other MIDI related information. Finally, an alphabetical INDEX lets you quickly reference the page number of any feature you want to locate.

### Special Symbols

Throughout this manual two special symbols are used to connote additional information.

#### CAUTION

Indicates an important cautionary note for the feature being described.

#### NOTE

Indicates a supplementary explanation for the feature being described.

# PRECAUTIONS

## ■ Location

Do not use the P-150 in locations where it will be exposed to direct sunlight, extreme temperatures, high humidity or excessive dust or vibration.

## ■ Handling

Avoid rough handling. Do not drop the P-150 or subject it to shock, as these can damage the instrument's internal circuitry. Also, do not apply excessive force to the controls or terminals. When moving the P-150, first unplug the AC power cord and all other cables to prevent damage to the cords and jacks. When removing plugs from terminals, always grip the plugs directly rather than pulling on the cord.

## ■ Cleaning

To clean the P-150, use a slightly moist cloth and a neutral cleanser. Do not use abrasive cleansers, waxes, solvents, or chemically treated cloths, as these may damage the cabinet's finish or dull the keys.

## ■ AC Power

The power requirements of your P-150 has been set to match the main power supply voltage in your area. Make sure that your local AC mains voltage matches the voltage as specified on the name plate located on the rear panel of your P-150. If you plan to use your P-150 in an area with a different voltage, be sure to use an appropriate converter. If you have any doubts about voltage compatibility, please consult your local Yamaha dealer.

## ■ Electromagnetic Interference

Avoid using your P-150 near televisions, radios or other devices which generate electromagnetic fields, as electromagnetic interference can cause the P-150 to malfunction, and may generate interference noise in the other devices as well.

## ■ Extended Disuse

Electrical storms can cause power surges which can damage the P-150's circuitry even if the power switch is turned off. Therefore, it is best to disconnect the P-150's power cord from the AC outlet when you will not be using it for an extended period of time.

## ■ Service and Modification

The P-150 contains no user serviceable parts, so never open the instrument's cabinet or tamper with the internal circuitry or mechanisms in any way. Doing so can result in electrical shock or damage to the P-150. Refer all servicing to qualified Yamaha service personnel.

## ■ Backup Battery

The P-150's internal settings are preserved by a lithium backup battery which has a life span of approximately five years. (The battery's life span may differ, depending on the time elapsed between your P-150's date of manufacture and the date you purchased it.) When the battery charge runs low, the "ERROR1 REPLACE BATTERY" error message will appear in the LCD screen. If this message appears, save any settings you may want to keep to an external data storage device (such as the Yamaha MDF2 Data Filer) using the bulk dump procedure, then contact a qualified Yamaha service center to have the battery replaced. Do not attempt to replace the backup battery yourself!

YAMAHA CANNOT BE HELD RESPONSIBLE FOR DAMAGE CAUSED BY IMPROPER HANDLING OR OPERATION OF THE P-150!

### NOTE

The LCD screen displays as illustrated in this manual are for instructional purposes only, and may appear somewhat different from your P-150's.

# CONTENTS

INTRODUCTION.....	1
PRECAUTIONS .....	2
UPPER PANEL.....	4
REAR PANEL .....	9
P-150 OVERVIEW .....	10
GETTING STARTED .....	14
Setting up the P-150 .....	14
Turning on the Power .....	16
Playing the Demo Songs .....	17
Playing the Voices .....	18
VOICE PLAY MODE .....	19
Single Mode .....	20
Stereo/Mono Piano .....	21
Electric/Upright Bass .....	21
Reverb Effects .....	22
Modulation Effects .....	23
Panel Equalizer.....	25
Main and Sub Voices.....	25
Dual Mode .....	26
Split Mode .....	28
Transpose .....	33
MIDI Transmit Enable .....	36
MIDI Panic .....	37
PERFORMANCE PLAY MODE .....	38
Selecting Single Voices .....	39
Selecting Dual Voices .....	40
Selecting Split Voices .....	40
EDIT MODE .....	42
System.....	44
MIDI Filter .....	46
Program Change (PC) Table .....	46
Channel .....	47
Local .....	48
Continuous Slider (CS) / Foot Controller (FC) .....	48
Panel Switch (PS).....	50
Name .....	50
Organ Combination.....	50
Pitch Bend Wheel (PB) / Modulation Wheel (MW) .....	51
Keyboard Sensitivity .....	51
Internal Equalizer .....	52
Reverb .....	52
Modulation .....	52
STORE .....	53
APPENDIX .....	55
Bulk Dump .....	55
Initialize.....	56
Using MIDI .....	57
Error Messages .....	60
Troubleshooting .....	61
Specifications.....	63
Factory Default Settings .....	64
Blank Chart.....	70
MIDI Data Format .....	72
MIDI Implementation Chart.....	81
Index .....	82

UPPER PANEL
REAR PANEL
P-150 OVERVIEW
GETTING STARTED
VOICE PLAY MODE
PERFORMANCE PLAY MODE
EDIT MODE
STORE
APPENDIX

# UPPER PANEL

UPPER PANEL

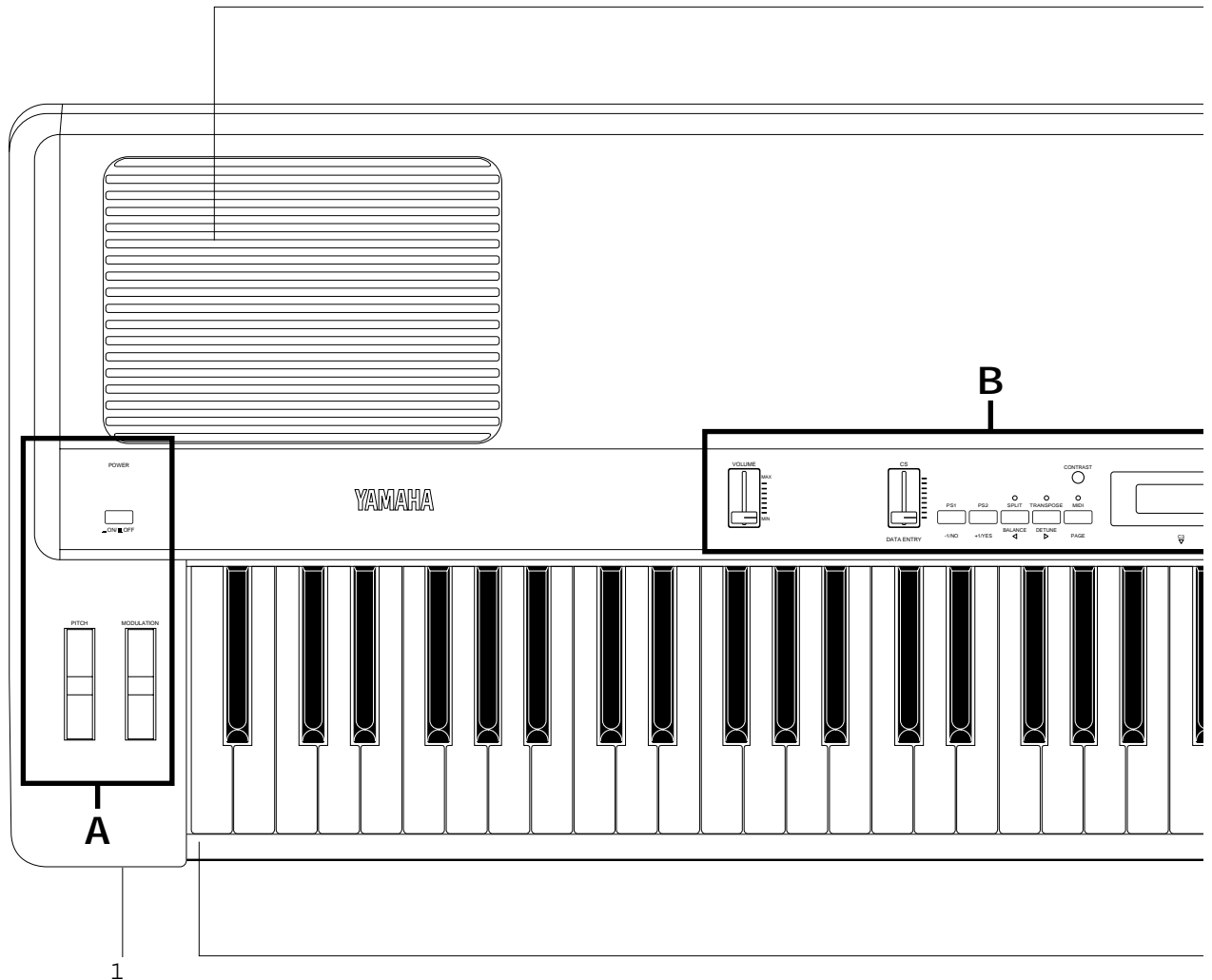

## 1 [PHONES] jack

This jack on the front panel lets you connect a pair of stereo headphones to the P-150 for private listening. The internal speakers will automatically be disconnected when you plug in the headphones. The sound of the internal voices output from the [OUTPUT] jacks is not affected.

## 2 Keyboard

This 88-key weighted action, touch-sensitive keyboard incorporates Yamaha's unique Action Effect II keyboard technology, which gives it the genuine feel and response of a real piano keyboard.

## 3 Speakers

These two built-in 13 cm speakers each provide an output of 20 watts. If you connect the P-150 to an external monitor system, you may choose to turn the speakers off using the [SPEAKER] switch located on the rear panel.



3

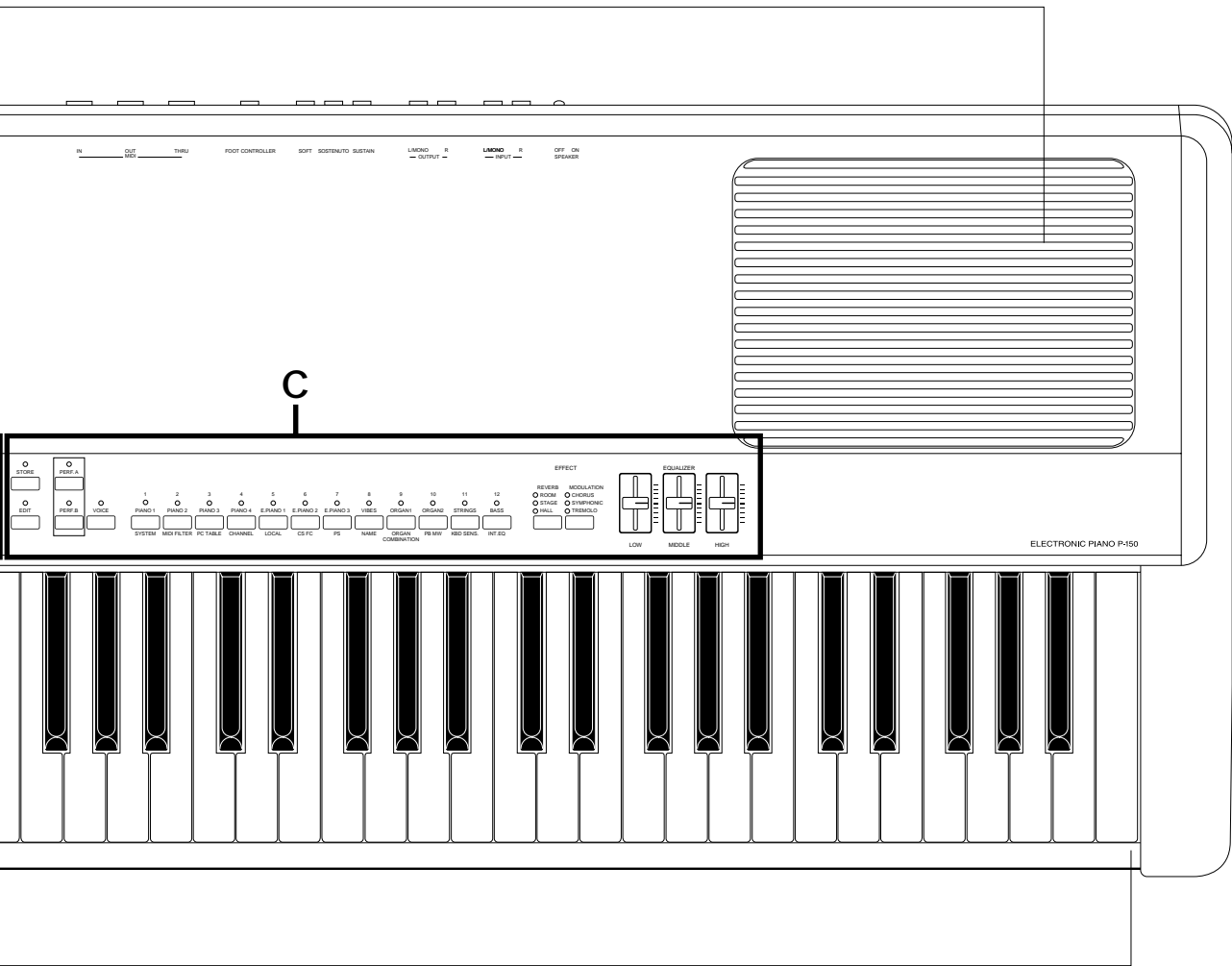

2

## ■ UPPER PANEL—A

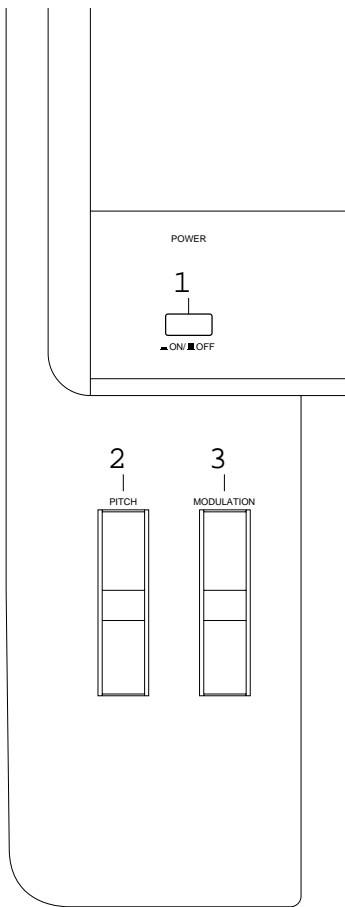

### 1 [POWER] switch

This switch turns the power on and off. When the power is turned on, the mode and status designated when the power was previously turned off will still be active.

### 2 [PITCH] wheel

This wheel can be used to bend the pitch of the notes that you play, up or down; the wheel automatically returns to the center position when you release it. (In Dual mode, both voices are affected; in Split mode, only the main voice is affected.) When the MIDI Transmit Switch is enabled, you can use it to transmit pitch bend messages to other instruments. You can assign the pitch bend range to any value within a one-octave range.

### 3 [MODULATION] wheel

This wheel can be used in various ways. Normally you will use it to apply a vibrato effect to the notes that you play, with increasing intensity as you roll it upwards; the wheel remains at the specific position that you set it when you let go of it. (In Dual mode, both voices are modulated; in Split mode, only the main voice is modulated. The vibrato effect cannot be applied to Piano voices 1 ~ 4.) You can also assign it to control reverb depth or modulation speed. When MIDI transmission is enabled, you can use it to transmit modulation messages to other instruments.

## ■ UPPER PANEL— B

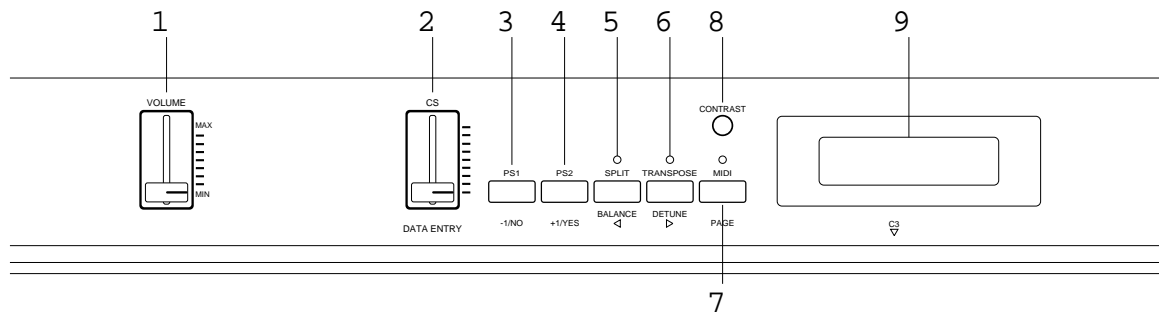

### 1 [VOLUME] slider

This slider adjusts the overall volume of sound output from the internal speakers (or headphones, if connected) as well as the sound output from the [OUTPUT] jacks on the rear panel. Moving the slider upward increases volume level, while moving the slider downward decreases volume level.

### 2 [CS, DATA ENTRY] slider

This is a multiple function slider. As a [CS] (continuous slider), you can assign it to control a variety of functions. As a [DATA ENTRY] slider, you can use it to change specific settings and parameters, depending on the current mode and status. Moving the slider upward increases the specified value, while moving the slider downward decreases the specified value.

### 3 [PS1, -1/NO] button

This is a dual function button. As a [PS1] (Panel Switch 1) button, you can assign it to control various functions of the internal voices as well as connected MIDI devices, as set by the PS Edit function. As a [-1/NO] button, you can use it to change parameter settings in decrements.

### 4 [PS2, +1/YES] button

This is a dual function button. As a [PS2] (Panel Switch 2) button, you can assign it to control various functions of the internal voices as well as connected MIDI devices, as set by the PS Edit function. As a [+1/YES] button, you can use it to change parameter settings in increments.

### 5 [SPLIT, BALANCE, 1] button

This is a multiple function button. As a [SPLIT] button, you can use it to enter Split mode, whether in Voice Play or Performance Play mode, determine the split point and assign the keyboard area for the main and sub voices. As a [BALANCE] button, you can use it to set the relative volume levels of each Split and Dual voice, by holding the [BALANCE] button and moving the [DATA ENTRY] slider ". As a [1] (cursor left) button in Edit mode, you can use it to move the cursor to the left in the LCD screen in order to position it over a desired parameter.

### 6 [TRANSPOSE, DETUNE, q] button

This is a multiple function button. As a [TRANSPOSE] button, you can use it to set the keyboard transpose value for single as well as both Dual voices or Split voices. As a [DETUNE] button, you can use it to set the detune value for the two Dual voices, by holding it and moving the [DATA ENTRY] slider ". As a [q] (cursor right) button in Edit mode, you can use it to move the cursor to the right in the LCD screen in order to position it over a desired parameter.

### 7 [MIDI, PAGE] button

This is a dual function button. As a [MIDI] transmit button, you can use it to quickly enable or disable the P-150's transmission of MIDI messages. You can also hold the [MIDI] button while pressing other buttons to access certain features. As a [PAGE] button, you can use it to step through the various pages of Edit functions when the P-150 is in Edit mode.

### 8 [CONTRAST] dial

This dial lets you adjust the contrast of the LCD screen for optimum visibility. Rotating it to the left will decrease screen contrast, while rotating it to the right will increase screen contrast.

### 9 LCD screen

This backlit 32-character Liquid Crystal Display screen provides various information about the modes and operating status of the P-150. Certain messages are displayed only temporarily, but you can designate the "Popup Time" according to your preference.

# ■ UPPER PANEL—C



UPPER PANEL

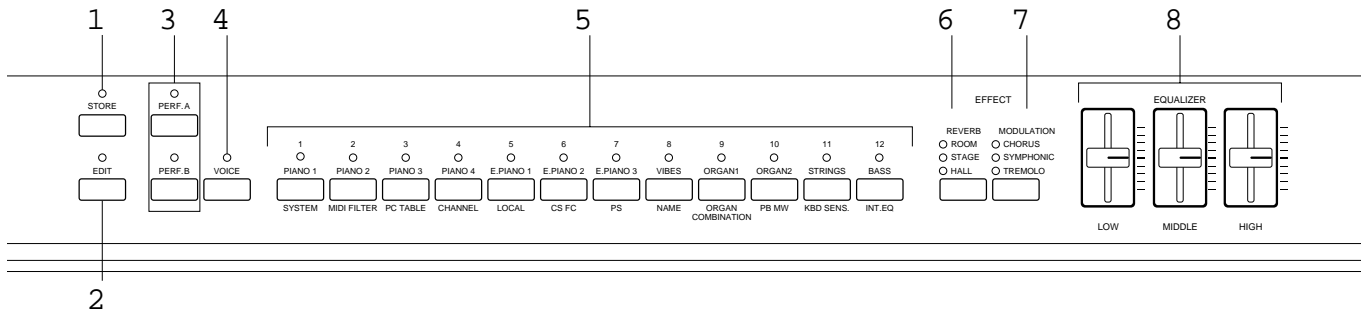

## 1 [STORE] button

This button lets you store changes that you make to a Performance, as well as copy the current Performance into any Performance memory. The P-150 can store 24 Performances.

## 2 [EDIT] button

This button lets you enter Edit mode and access the various Edit functions. After pressing it once, the LED above the [EDIT] button will begin blinking, as will the light above the currently selected [EDIT SELECT] button  $\%$ . Pressing it again will return you to the previous Play mode.

## 3 [PERF. A, B] buttons

These buttons let you enter Performance Play mode and select any of the 24 Performances. The P-150 is set at the factory with 24 Preset Performances, but you can overwrite them and store User Performances which you create yourself. The [PERF. A] and [PERF. B] banks hold 12 Performances each, and a lit LED above one of the buttons indicates the currently active bank.

## 4 [VOICE] button

This button lets you enter Voice Play mode by pressing [VOICE] and then pressing a [VOICE SELECT] button  $\%$ . A lit LED above the [VOICE] button indicates you're in Voice Play mode.

## 5 [VOICE, PERFORMANCE, EDIT SELECT] buttons

These 12 buttons each have multiple functions, depending on the current mode. In Voice Play mode you can use them to select any of the 12 preset AWM instrument voices you want to play; the voice names are printed in red above the buttons. In Performance Play mode you can use them to select any of the 24 Performances (12 Performances per bank); the Performance numbers are printed above the buttons. In Edit mode, you can use them to select the Edit functions; the Edit function names are printed in green below the buttons.

## 6 [REVERB] button

This button lets you select either a Room, Stage or Hall reverb effect, or no reverb effect, to apply to the currently selected voice. Each voice has a default reverb setting preprogrammed at the factory which you can change.

## 7 [MODULATION] button

This button lets you select either a Chorus, Symphonic or Tremolo modulation effect, or no modulation effect, to apply to the currently selected voice. Each voice has a default modulation setting preprogrammed at the factory which you can change.

## 8 [EQUALIZER] sliders

These sliders let you graphically adjust the level of the sound output of the P-150 in three bands: High, Middle and Low. In Dual and Split modes, the changes you make will affect both voices.

# REAR PANEL

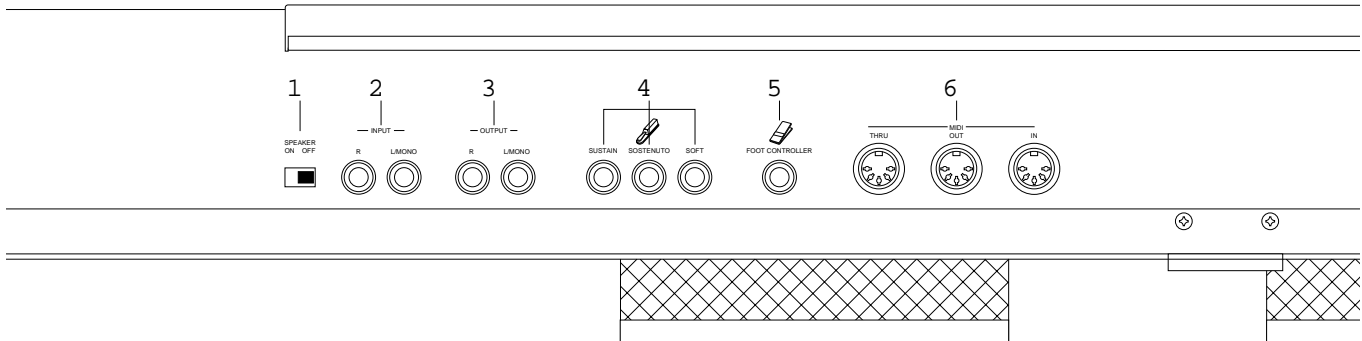

## 1 [SPEAKER] switch

This switch lets you turn off the P-150's internal speakers. It does not affect the output from the [OUTPUT] jacks or the [PHONES] jack.

## 2 [INPUT] jacks

These jacks let you input line-level signals from another electronic instrument, such as a rhythm programmer, external tone generator, or synthesizer, and monitor it through the P-150's internal speakers. Use the [L/MONO] jack when connecting only a single line.

## 3 [OUTPUT] jacks

These jacks output line-level signals which can be input directly to an external amplifier, mixer or other audio device. Use the [L/MONO] jack if your audio equipment has only one input.

## 4 Pedal jacks

These jacks let you connect up to three foot pedals and use them as sustain, sostenuto and soft pedals. A single FC4 footswitch is included with your P-150. If you wish to attach additional foot pedals, be sure to use only Yamaha models FC4 or FC5.

## 5 [FOOT CONTROLLER] jack

This jack lets you connect a foot controller (Yamaha FC7, available separately) for use as an auxiliary controller. The [FC] foot controller can be assigned to control a variety of functions, including reverb depth or modulation speed, which lets you change these parameters by foot as you play.

## 6 [MIDI] terminals

These terminals allow the P-150 to communicate with other MIDI devices, using standard MIDI cables. To control the P-150 using a sequencer or another keyboard, connect the MIDI out jack of the external device to the [MIDI IN] jack of the P-150. To control another device (such as a synthesizer or tone generator) using the P-150, connect the [MIDI OUT] jack of the P-150 to the MIDI in jack of the external device. The [MIDI THRU] jack simply passes the data received at the P-150's [MIDI IN] jack through unaffected, and is used when connecting three or more MIDI devices in a series.

# P-150 OVERVIEW

## ■ Voice Play and Performance Play Modes

The P-150 has two basic Play modes, Voice Play mode and Performance Play mode. Within each mode are various Voice and Performance parameters, or settings that you can change, which make up the sound of the selected voice and the specific operating status of the P-150.

A group of overall System settings apply to both Voice Play and Performance Play modes, and Edit mode lets you access and edit a wide variety of System and other functions, as shown in the following illustration.

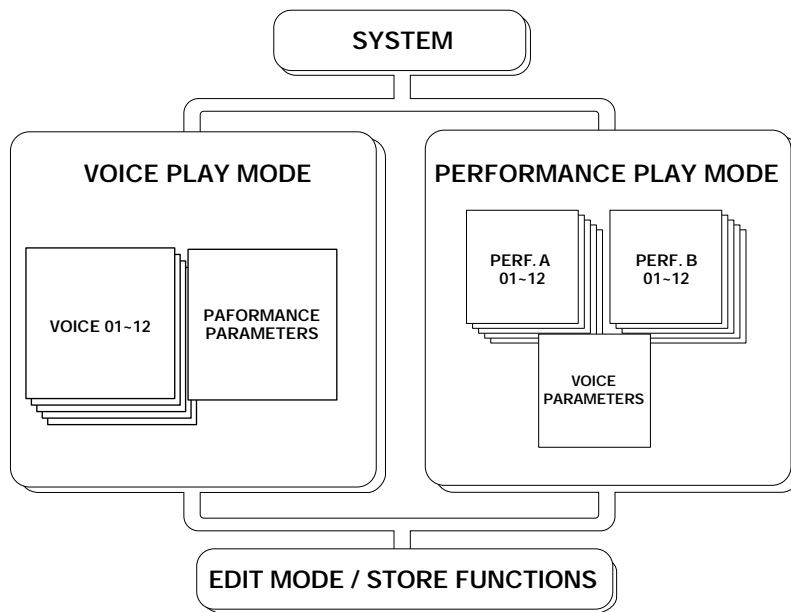

As the above illustration shows, the primary difference between Voice Play mode and Performance Play mode is:

- In Voice Play mode, a single set of Performance parameter settings apply to any voice (and its specified Voice parameter settings) which you select.
- In Performance Play mode, a complete set of Performance parameters can be configured specifically for any particular voice (and its specified Voice parameter settings). The P-150 can store up to 24 Performances for instant recall.

Normally you will operate in Voice Play mode, Auto Store status (See “About Store Type”, next page)—as you select sounds and make parameter assignments as dictated by your current music session. Then you can store those settings to any of the 24 Performances, which you can then access at any time by the press of a [PERFORMANCE SELECT] button in Performance Play mode. (You can also perform bulk dump operations of Performance data to and from an external MIDI device such as the Yamaha MDF2 MIDI Data Filer.)

## ABOUT STORE TYPE

You can choose the Store Type—Non Auto Store and Auto Store.

When Non Auto Store is selected, the store operation is always required (except when modifying System related parameters; see page 13) if you want to save the current settings.

When Auto Store is selected, all changes you make will automatically be stored without the need to perform a specific storing procedure.

The default setting for a new (or initialized) P-150 is Non Auto Store. (For information about changing the Store Type, see page 45.)

Explanations in this Owner's Manual assume that Auto Store is selected. Therefore, the LCD illustrations herein may be slightly different than the screens on your P-150.

## ■ Voice Parameters

In Voice Play mode, each of the P-150's AWM instrument voices have a set of Voice parameters that are initially set at the factory, but which you can change to suit your needs.

These include controller parameters such as pitch bend range and modulation wheel assignment, keyboard sensitivity parameters for internal or MIDI applications, and effect parameters such as reverb type and depth, modulation type and speed, and internal equalizer settings.

In Voice Play mode you can access a single set of Performance parameters and in Performance Play mode you can access 24 sets of Performance parameters. Although you can freely change the voices in Performance Play mode, only a single set of Voice parameters is available for each Performance.

VOICE PARAMETERS	
CONTROLLERS	<ul style="list-style-type: none"> <li>• Pitch Bend Range</li> <li>• Modulation Wheel Assign</li> </ul>
KEYBOARD SENSITIVITY	<ul style="list-style-type: none"> <li>• Internal</li> <li>• MIDI</li> </ul>
EFFECT	<ul style="list-style-type: none"> <li>• Reverb Type, Speed</li> <li>• Modulation Type, Speed</li> <li>• Equalizer (Internal) Low, Mid, High</li> </ul>

## ■ Performance Parameters

In Performance Play mode, the P-150 has 24 sets of Performance parameters which let you configure settings for specific music situations (i.e., for a certain style of music, or a particular song, or for a practice session, or a live set, etc.). This affords you the convenience of being able to recall those settings instantly at the press of a button when in Performance Play mode.

Performance parameters include the voice selection (a set of voice parameters), keyboard Single, Dual or Split mode and settings, main and sub voice assignments, User organ combination values, transposition values, keyboard local on or off setting, MIDI transmit and receive channel numbers, plus function assignments for [PS1], [PS2], [CS] and [FC] (foot controller), the Performance name and others.

In Voice Play mode you can specify settings for a single set of Performance parameters.

Performance Parameters	
VOICE SELECT	12 voices (A set of voice parameters)
KEYBOARD MODE	Single, Dual, Split
VOICE	Main, Sub
PIANO 1/2	Stereo, Mono
BASS	Electric, Upright
ORGAN COMBINATION	<ul style="list-style-type: none"> <li>• Footage</li> <li>• Response, Attack (Length and Mode)</li> </ul>
BALANCE	-16 ~ 15
DETUNE	0 ~ 7
SPLIT POINT	<ul style="list-style-type: none"> <li>• A-1 ~ C7</li> <li>• MAIN VOICE (Upper, Lower)</li> </ul>
TRANPOSE	<ul style="list-style-type: none"> <li>• Enable Switch</li> <li>• Internal Main, Sub</li> <li>• MIDI Main, Sub</li> </ul>
MIDI CHANNEL	<ul style="list-style-type: none"> <li>• Transmit</li> <li>• Receive</li> </ul>
LOCAL	On, Off
CONTROLLERS	<ul style="list-style-type: none"> <li>• PS 1/2 Assign</li> <li>• CS Assign, Range</li> <li>• FC Assign, Range</li> </ul>
NAME	Character select



## ■ System Settings

The P-150's overall System settings encompass those "global" parameters which are related to the instrument as a whole, and which therefore affect both Voice Play and Performance Play modes.

These include master tuning, MIDI transmit enable, MIDI filter transmit and receive parameter settings, MIDI program change table settings, and others.

SYSTEM	
MIDI TRANSMIT ENABLE	On, Off
SYSTEM	<ul style="list-style-type: none"> <li>• Master Tune</li> <li>• Reverb Bypass</li> <li>• Device Number</li> <li>• MIDI Merge</li> <li>• Performance Enable</li> <li>• Popup Time</li> <li>• Store Type</li> </ul>
MIDI FILTER	<ul style="list-style-type: none"> <li>• Transmit</li> <li>• Receive</li> </ul>
PROGRAM CHANGE TABLE	<ul style="list-style-type: none"> <li>• Transmit Number, Bank Select Number</li> <li>• Receive Number</li> </ul>

## ■ Editing and Storing Features

When the P-150 is in Edit mode, you can access and modify the System and other parameters.

A convenient Auto Store feature (which you can disengage) automatically stores the System settings and other parameters as you change them. Within either Voice Play mode or Performance Play mode, you can store the current set of all settings as a User Performance.

There is a fine distinction between Voice Play mode store and Performance Play mode store functions. In Voice Play mode, you can overwrite the current set of Voice and Performance parameter settings. In Performance Play mode, you can select a specific destination Performance in which to store the current Performance parameter settings. Therefore, if you select a destination Performance in which to store the current Voice Play mode Performance parameter settings, you are storing it in the Performance Play mode.

You will find it most convenient to set up your Performances in Voice Play mode, Auto Store status, since voice selection is so simple, then copy it to one of the 24 Performance memories for instant recall when you need it.

By switching into Non Auto Store status, you can be sure that your Performances are protected, and any changes you make in one will not be applied unless you specifically store, or overwrite, it. In Edit mode, the P-150 will prompt you automatically whether or not to overwrite the current changes.

You can also dump Performance data to and from external MIDI devices.

### NOTE

Descriptions of all parameters and details about how to access and manipulate them are provided in the appropriate sections herein. Also see the Blank Chart on page 65.

# GETTING STARTED

## ■ Setting up the P-150

Although setting up the P-150 for basic play is easy and straightforward, be sure to take heed of the Precautions on page 2 before you begin, then carefully follow the simple steps as outlined below.

### P-150 SETUP PROCEDURE

1. Prepare a suitable location.
  - The P-150 is relatively small for an 88-key instrument, but it is very solidly built and therefore quite heavy. First you'll want to prepare a suitable location for your P-150. Please do not hesitate to ask someone to help you take it out of the box and carefully place it on an optionally available Yamaha LP-3 keyboard stand or a sturdy table.
2. Plug in the power cord.
  - Next plug the P-150's power cord into an AC outlet. Do not turn on the [POWER] switch until you have made all connections as described below.
3. Connect the sustain pedal.
  - Next plug the supplied FC4 footswitch into the [SUSTAIN] jack on the rear panel, so you can use it as a sustain pedal. If you have purchased additional FC4 or FC5 footswitches, connect them to the [SOSTENUTO] and [SOFT] jacks.

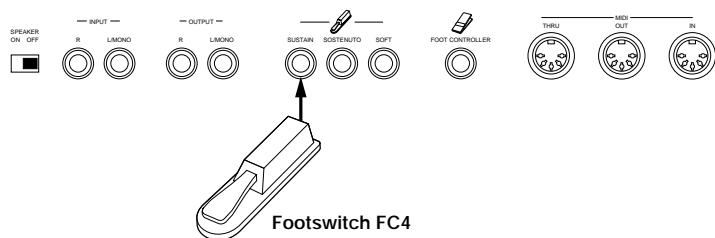

4. Connect external line-level components.  
 If you wish to monitor the P-150's output using an external line-level mixer or amplifier, connect the input of the external component to the P-150's [OUTPUT] jacks on the rear panel. (Use both jacks for stereo output; use the [L/MONO] jack for mono output.)

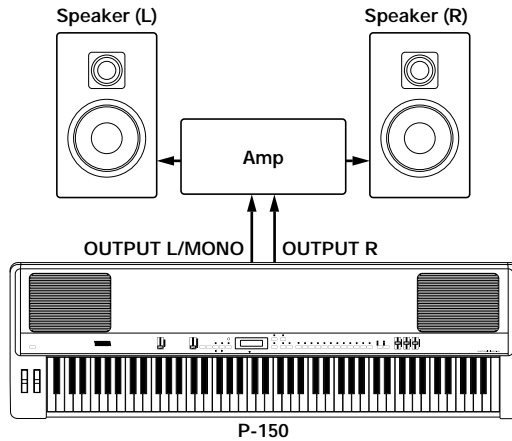

If you wish to listen to your P-150 using headphones, connect a pair of stereo headphones to the [PHONES] jack located on the left side of the front panel. The P-150's internal speakers will automatically be disconnected whenever headphones are plugged into the [PHONES] jack.

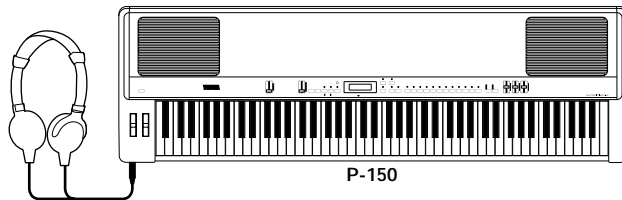

If you wish to monitor the output of an external line-level device (such as a rhythm programmer, tone generator or synthesizer) via the P-150's internal speakers, connect the output of the external device to the P-150's [INPUT] jacks on the rear panel. (Use both jacks for stereo input; use the [L/MONO] jack for mono input.)

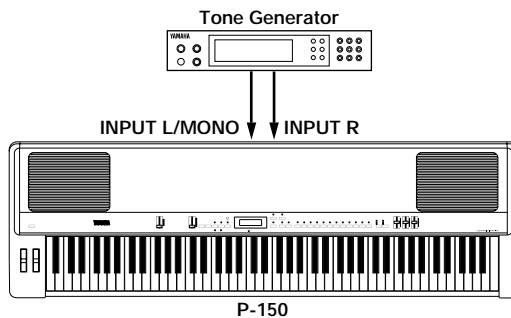

**CAUTION**

Before connecting the P-150 to any external device, be sure that the power switches of all devices are turned off.

- 5.** Connect MIDI devices.
- If you wish to connect the P-150 to external MIDI devices such as a rhythm programmer, tone generator or synthesizer, you will need special MIDI cables which plug into the [MIDI] jacks on the rear panel. First, however, you must determine a MIDI system configuration, based on your particular needs or desires. Some examples of MIDI system connections, along with information about MIDI, are provided on page 57.

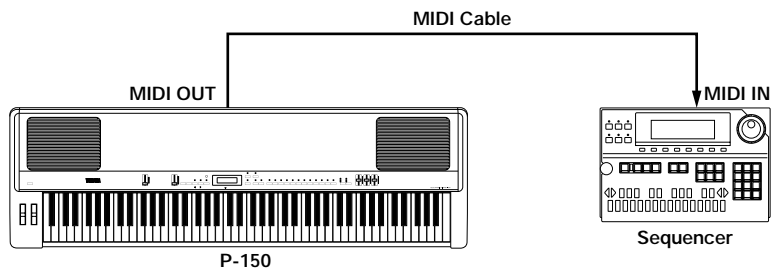

- 6.** Attach the music stand.
- Finally, attach the supplied music stand to the P-150 by carefully inserting it into the groove located along the rear edge of the upper panel.

## ■ Turning on the Power

After setting up the P-150, you're ready to turn on the power and begin enjoying the instrument's great sounds and many versatile performance and other features.

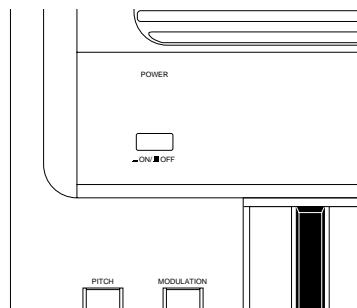

Switch on the [POWER] button, then gradually raise the [VOLUME] slider until you obtain a comfortable listening level.

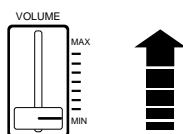

### CAUTION

Always turn the P-150 on first, and then turn on external MIDI and audio devices last. However, if a line-level device is plugged into the P-150's [INPUT] jacks, turn it on before turning on the P-150. When turning off the power of each device, simply reverse the process.

## ■ Playing the Demo Songs

After setting up the P-150 and switching on the power, and before you begin exploring the instrument's various features, you may want to listen to the three preprogrammed Demo songs which demonstrate the P-150's exceptional sound and performance capabilities. To do so, follow the steps below.

### HOW TO PLAY THE DEMO SONGS

1. Enter Demo Play mode.
  1. Press the [REVERB] and [MODULATION] buttons simultaneously. The following screen appears.

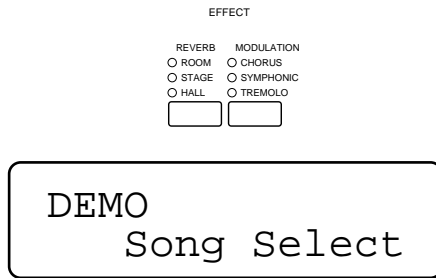

2. Select and play a Demo song.
  1. Immediately after pressing [REVERB] and [MODULATION] (step 1, above), press the [MODULATION] button once or more to select a Demo song. For example, press the button once to select the first Demo song ("Song 1 Play"), or twice to select the second Demo song ("Song 2 Play"), or three times to select the third Demo song ("Song 3 Play"). The song you select will begin playing automatically.

#### NOTE

If you don't press the [MODULATION] button quickly after having entered Demo Play mode, the P-150 will automatically exit Demo Play mode.

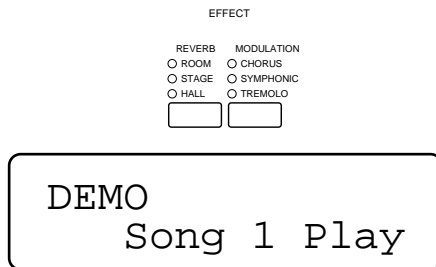

If you press the [MODULATION] button four times, the message "Song all" will appear in the LCD screen, and the P-150 will play all three Demo songs continuously, one after the other.



- 3.** Exit Demo Play mode.  
 If you select “Song 1 Play”, “Song 2 Play” or “Song 3 Play” the P-150 will exit the Demo Play mode automatically when the selected song finishes playing.  
 To exit Demo Play mode while a song is playing, simply press the [REVERB] button.

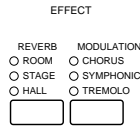

**NOTE**

You cannot enter Demo Play mode (or any other Play mode) when the P-150 is in Edit mode. (The LED above the [EDIT] button will blink when the P-150 is in Edit mode.) To exit Edit mode, simply press the [EDIT] button. Also note that you will not be able to play the P-150 or use any of the Edit mode functions while a Demo song is playing.

## ■ Playing the Voices

Selecting and playing the voices of a new P-150 is simple, since by default the instrument starts up for the first time in Voice Play mode with initialized parameter settings, PIANO 1 voice selected.

Therefore, all you have to do is press a [VOICE SELECT] button and start playing the keyboard. Take a few minutes and try playing each of the voices and notice the rich quality and dimension of the P-150’s AWM sound, complete with the nuance of natural expression via the keyboard.

As you play, try out the [PITCH] wheel, which lets you bend notes up or down. Also try out the [MODULATION] wheel, which lets you add varying degrees of vibrato (or other effects) to the voices.

While you’re at it, try out the various reverb and modulation effects, by pressing the [REVERB] and [MODULATION] buttons once or more.

When you’re ready for more, turn the page, and find out about all the P-150 has in store.

**NOTE**

You can assign a specific effect to the [MODULATION] wheel in Edit mode (see page 51) which is completely unrelated to the modulation effects available by pressing the [MODULATION] button (see page 23) once or more. Note that when the vibrato effect is assigned to the [MODULATION] wheel, you cannot apply vibrato modulation to the Piano voices 1 ~ 4. Also note that the reverb depth or modulation speed may be set at 0 for certain voices, and therefore produce no noticeable effect. (For information about changing reverb depth, see page 22. For information about changing modulation speed, see page 23.)

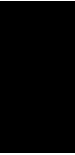

# VOICE PLAY MODE

## ENTERING AND EXITING VOICE PLAY MODE

1. Press the [VOICE] button.  
When you press the [VOICE] button while the P-150 is in Performance Play mode, the LED above the [VOICE] button starts blinking, indicating that Voice Play mode is standing by waiting to be activated.



2. Press a [VOICE SELECT] button.  
As soon as a [VOICE SELECT] button is pressed, Voice Play Single mode is activated.  
The LED above the [VOICE] button and the selected [VOICE SELECT] button will light.

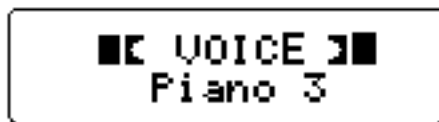
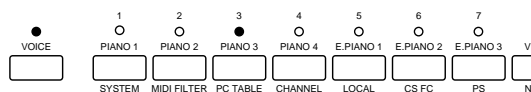

From within Single mode you can easily activate Dual mode (see page 26) or Split mode (see page 28).

To exit Voice Play mode, simply enter Performance Play mode. For details, see page 38.

## ■ Single Mode

When the P-150 is in Single mode, you can select and play any one of the 12 voices over the full range of the keyboard. You can also apply and adjust reverb and modulation effects, and adjust the graphic equalizer settings.

In Single mode, the LED above the currently selected [VOICE SELECT] button lights, and the name of the currently selected Single voice appears in the LCD screen.

### SELECTING A SINGLE VOICE

Press a [VOICE SELECT] button.

To select a voice you need only press any of the 12 [VOICE SELECT] buttons.

#### Voices and Polyphony

The P-150's voices are high quality samples of real musical instruments generated by Yamaha's exclusive AWM (Advanced Wave Memory) tone generation process.

All of the voices have 32-note polyphony, which means that a maximum number of 32 notes can be played simultaneously. This is crucial for achieving uncompromising sound and performance when using a sustain pedal, where certain notes must hold over others as you play, until you release the sustain pedal.

There is an extra dimension to some of the P-150's voices. Two of the PIANO voices have special stereo settings, which are capable of 16-note polyphonic output. Also, the BASS voice has both ELECTRIC BASS and acoustic UPRIGHT BASS settings.

The following table provides an overview of each preset AWM voice.

NO.	VOICE	DESCRIPTION	SAMPLE TYPE	POLYPHONY
1	PIANO 1	Acoustic grand piano, suitable for various types of music, from classical to jazz.	Mono / Stereo	32 / 16
2	PIANO 2	Acoustic grand piano, with sophisticated and deeper resonance and body.	Mono / Stereo	32 / 16
3	PIANO 3	Bright acoustic grand piano, ideal for rock as well as jazz.	Mono	32
4	PIANO 4	Bright electric grand piano, ideal for pop ballads.	Mono	32
5	E. PIANO 1	Standard electric piano with a sharp attack sound.	Mono	32
6	E. PIANO 2	Conventional, all-purpose electric piano sound.	Mono	32
7	E. PIANO 3	Bright and sparkling, DX-type electric piano sound.	Mono	32
8	VIBES	Full-bodied vibraphones with sharp attack.	Mono	16 (2 layered)
9	ORGAN 1	Full-set organ combination sound with editable footage lengths and other parameters.	Mono	8
10	ORGAN 2	Standard jazz organ sound.	Mono	32
11	STRINGS	Full orchestral string ensemble.	Mono	32
12	BASS	Deep Electric Bass with punch, and full-bodied, resonating Upright Bass.	Mono	32

#### NOTE

The Organ 1 voice can be edited and reconfigured in Edit mode (see page 50).



## ■ Stereo/Mono Piano

Pressing and holding the [PIANO 1] (or [PIANO 2]) button for a few moments alternately selects the stereo and mono settings.

The initial default setting for the PIANO 1 (and PIANO 2) voice is stereo, and polyphony is 16 notes.

### CHANGING THE PIANO VOICE SETTING

Press and hold [PIANO 1] (or [PIANO 2]) for a few moments. After a moment, the MONO screen briefly appears.

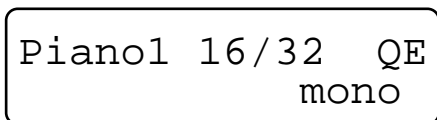
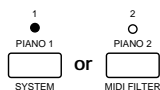

As you play the keyboard, the output of the PIANO 1 voice will be in mono, and polyphony will be 32 notes.

To return the PIANO 1 voice to its stereo setting, simply press and hold [PIANO 1] for a few moments again. The STEREO screen briefly appears.

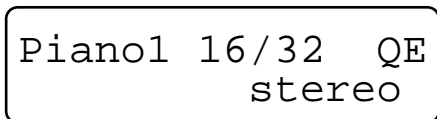

## ■ Electric/Upright Bass

Pressing and holding the [BASS] button for a few moments alternately selects the Electric and Upright settings.

The initial default setting for the BASS voice is Electric Bass.

### CHANGING THE BASS VOICE SETTING

Press and hold [BASS] for a few moments. After a moment, the UPRIGHT BASS screen briefly appears.

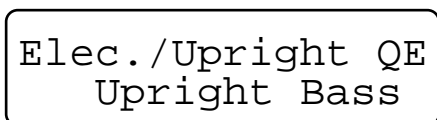

#### NOTE

Once you have modified certain parameters in Voice Play or Performance Play mode, QE (Quick Edit) will display in the upper right corner to remind you that you have modified the original settings. Parameters include the following: reverb and modulation setting, stereo/mono setting for Piano1 and Piano2, electric/upright setting for Bass, plus Balance, Dual Detune, Split, and Transpose settings.

As you play the keyboard, you will hear the Upright Bass voice.

To change back to the ELECTRIC BASS voice, simply press and hold [BASS] for a few moments again. The ELECTRIC BASS screen briefly appears.

Elec./Upright QE  
Elec.Bass

## ■ Reverb Effects

The P-150's internal DSP digital signal processor generates three types of realistic reverb effects, or simulated ambient environments, which you can apply to the voices.

These include ROOM, which simulates the natural reverberations of sound in a normal-sized room, STAGE, which simulates the natural reverberations of sound in a night club, and HALL, which simulates the natural reverberations of sound in a relatively large concert hall.

As you select each voice you will notice that a specific reverb effect is already assigned to it, indicated by a lit LED to the left of the name of the selected reverb type. These are the initial default assignments set at the factory, but you can select any reverb effect you wish for each voice, or even turn the reverb effect off. You can also change reverb depth on the spot.

## SELECTING A REVERB TYPE

Press the [REVERB] button once or more.

When you press the [REVERB] button repeatedly, the reverb types will be selected in order as follows: ROOM, STAGE, HALL, then OFF. (No lit LED represents Off status.)

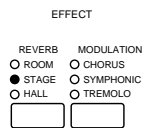

### NOTE

You can also select the reverb type and depth settings in Edit mode (see page 52).

Note that each time you select a reverb type, a message will briefly display in the LCD screen, as follows.

REVERB DEPTH QE  
2 <>

This temporary message displays the current depth level for the reverb type that you just selected, between 0 and 7.

You can easily change the depth level for the currently selected reverb type.

## CHANGING REVERB DEPTH

1. Hold the [REVERB] button and move the [DATA ENTRY] slider (or press [-1/NO] or [+1/YES]).  
As soon as you move the [DATA ENTRY] slider (or press [-1/NO] or [+1/YES]) the REVERB DEPTH screen appears.

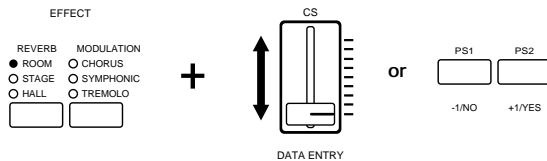

If you move the [DATA ENTRY] slider upward, the depth level increases; if you move the [DATA ENTRY] slider downward, the depth level decreases.

A value of 7 will produce the largest number of reverberations, whereas a value of 0 will effectively turn the reverb off.

2. Release the [REVERB] button.  
After a moment, the voice name will reappear in the screen.

Try different settings and play the keyboard and notice the difference between high and low reverb depth level settings, and the P-150's wide variety of reverb options.

### NOTE

In Voice Play mode, a different reverb type and depth can be selected for each voice. When you play two voices in either Dual or Split mode, the P-150 will apply the main voice reverb type and depth setting to both voices, and ignore any settings which you may have made for the sub voice. For more information about main and sub voices, see page 25.

## Modulation Effects

The P-150's internal DSP digital signal processor generates three types of modulation effects which you can apply to the voices. (Note: These modulation effects are unrelated to the vibrato effect which you can apply to voices using the [MODULATION] wheel. For details about the vibrato effect, see page 52.)

These include CHORUS, a modulated delay which effectively makes a voice sound like more than one instrument is being played, SYMPHONIC, a more pronounced chorus effect, and TREMOLO, a rotating speaker effect.

As you select each voice you will notice that most have a specific modulation effect already assigned to them, indicated by a lit LED to the left of the name of the selected modulation effect type. These are the initial default assignments set at the factory, but you can select any modulation effect you wish for each voice, or even turn the modulation effect off. You can also change modulation speed on the spot.

## SELECTING A MODULATION TYPE

Press the [MODULATION] button once or more.  
When you press the [MODULATION] button repeatedly, the modulation types will be selected in order as follows: CHORUS, SYMPHONIC, TREMOLO, then OFF. (No lit LED represents Off status.)

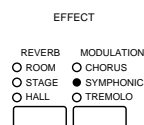

### NOTE

You can also select the modulation type and speed settings in Edit mode (see page 52).

Note that each time you select a modulation type, a message will briefly display in the LCD screen, as follows.

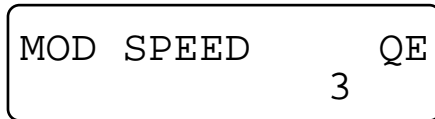

This temporary message displays the current speed level for the modulation type that you just selected, between 0 and 7. You can easily change the speed level for the currently selected modulation type.

## CHANGING MODULATION SPEED

1. Hold the [MODULATION] button and move the [DATA ENTRY] slider (or press [-1/NO] or [+1/YES]).  
As soon as you move the [DATA ENTRY] slider (or press [-1/NO] or [+1/YES]) the MODULATION SPEED screen appears.

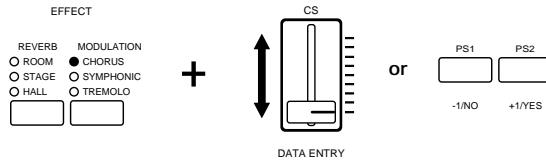

If you move the [DATA ENTRY] slider upward, the speed level increases; if you move the [DATA ENTRY] slider downward, the speed level decreases. A value of 7 will produce the largest number of modulations, whereas a value of 0 will effectively turn the modulation off.

### NOTE

A different modulation type and speed can be selected for each voice. When you play two voices in either Dual or Split mode, the P-150 will apply the main voice modulation type and speed setting to both voices, and ignore any settings which you may have made for the sub voice. For more information about main and sub voices, see page 25.

2. Release the [MODULATION] button.  
After a moment, the voice name will reappear in the screen.  
Try different settings and play the keyboard and notice the difference between high and low modulation speed level settings.

## ■ Panel Equalizer

The P-150's three-band equalizer works just like a graphic equalizer found on many home stereo amplifiers. The three sliders provide direct access to the P-150's output in LOW, MIDDLE and HIGH frequency ranges, which gives you considerable control over the quality of the sound.

### NOTE

An Internal Equalizer accessible in Edit mode lets you adjust the frequency ranges for each voice. For details, see page 52.

## ADJUSTING THE EQUALIZATION

Move an [EQUALIZER] slider up or down.

Move either the [LOW], [MIDDLE] or [HIGH] slider upward to increase the level of output for that range, or move it downward to decrease the level of output for that range.

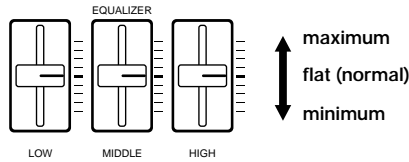

The graph below shows how the equalizer modifies the sound output of each range.

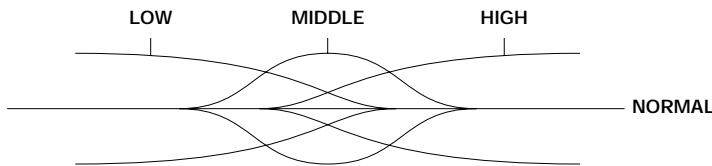

## ■ Main and Sub Voices

The P-150 is capable of generating two different AWM voices at once, either in Dual mode or Split mode. These are divided into main and sub voice areas of the keyboard which can be assigned to either end of the keyboard.

In Dual mode, the order that you press the [SELECT] buttons will determine which voice is the main voice and which is the sub voice. Since both voices are sounded simultaneously, the distinction between the main voice and sub voice is not important when you play the keyboard, but you'll need to keep it in mind when setting the detune relationship and balance levels. (For details about Dual mode, see page 26.)

In Split mode, the main and sub voices each are assigned to separate areas of the keyboard, known as the main and sub keyboard areas. The two keyboard areas are separated at a specified key known as the split point. You can determine the split point, assign the main and sub voices to either end of the keyboard, and adjust the volume balance of the two voices in relation to each other. In general, the main keyboard area is normally above the split point; however, there may be cases when you'll want to play the main voice below the split point. (For details about Split mode, see page 28.)

Note that when you play two voices in either Dual or Split mode, the P-150 will apply the main voice reverb type and depth setting and modulation type and speed setting to both voices, and ignore any settings which you may have made for the sub voice.

# ■ Dual Mode

When the P-150 is in Dual mode, you can play two voices at the same time—a main voice and a sub voice—over the full range of the keyboard. For example, you can blend electric piano and strings sounds together to add depth and texture to a melody line.

You can adjust the volume balance of the Dual voices in relation to each other, as well as detune the voices in order to enrich the sound by bringing out the individual characteristics of each Dual voice. You can also transpose each Dual voice (for details, see page 35).

**NOTE**

In Dual mode you cannot select the Organ 1 voice.

## ENTERING AND EXITING DUAL MODE

1. Main Voice: Press and hold a [VOICE SELECT] button.
2. Sub Voice: While still holding the first button, simply press another [VOICE SELECT] button.  
The LED above each [VOICE SELECT] button lights, and those two voices will sound when you play the keyboard.

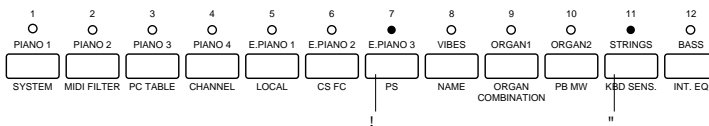

The order that you press the buttons will determine which voice is the main voice and which voice is the sub voice. For example, if you press and hold [E. PIANO 3] and then press [STRINGS], the ELECTRIC PIANO 3 voice will be the main voice, and the STRINGS voice will be the sub voice.

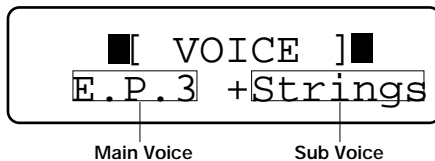

In Dual mode, since both voices are sounded simultaneously, the distinction between the main voice and sub voice is not important when you play the keyboard. However, you will want to keep it in mind when adjusting the voice balance and detune settings, as described below.

When you select voices in Dual mode, the P-150 will apply the main voice reverb type and depth setting and modulation type and speed setting to both voices, and ignore any settings which you may have made for the sub voice. Also, [PITCH] and [MODULATION] wheels apply to both voices equally, with the values as set for the main voice.

**NOTE**

In Dual mode, voice polyphony is determined by the voices you select. For example, if you select two 32-note polyphonic voices, polyphony will be reduced to 16 notes. If you select a 32-note voice and a 16-note (stereo) voice, polyphony will be reduced to 10 notes. Likewise, if you select two 16-note (stereo) voices, polyphony will be reduced to 8 notes.

To exit Dual mode, simply press a single [VOICE SELECT] button to return to Single mode, or press [SPLIT] and enter Split mode.

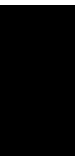

VOICE PLAY MODE

## ADJUSTING THE BALANCE OF THE DUAL VOICES

1. Hold the [BALANCE] button and move the [DATA ENTRY] slider.
  - As you move the [DATA ENTRY] slider, the DUAL BALANCE screen appears.

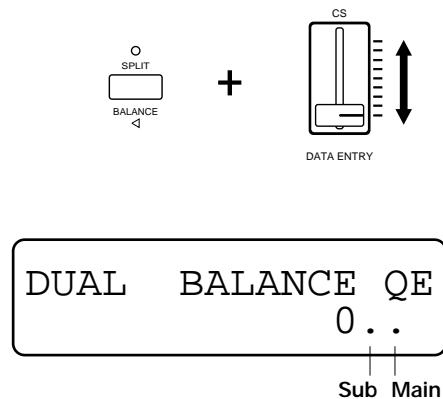

Moving the slider upwards increases the level of the main voice while decreasing the level of the sub voice. Conversely, moving the slider downwards increases the level of the sub voice while decreasing the level of the main voice. You can set the balance to any value between -16 and 15. Two indicators to the right of the numeric value display the relative balance of sub and main voices.

You'll find it convenient to set the desired balance by holding the [BALANCE] button and moving the [DATA ENTRY] slider with one hand, and then playing the keyboard with the other hand.

2. Release the [BALANCE] button.
  - After a moment, the Dual voice names will reappear in the screen.

If you choose different Dual voices, the balance relationship will remain the same as determined above, until you change the balance setting again.

## DETUNING THE DUAL VOICES

1. Hold the [DETUNE] button and move the [DATA ENTRY] slider.
  - As you hold the [DETUNE] button, do not press a key on the keyboard until you move the [DATA ENTRY] slider. (Note: If you press a key on the keyboard before moving the [DATA ENTRY] slider, you will change the Transpose setting. For information about the Transpose feature, see page 33.)



### NOTE

In this case you cannot use the [-1/NO] and [+1/YES] buttons to change data.

As you move the [DATA ENTRY] slider, the DUAL DETUNE screen appears.

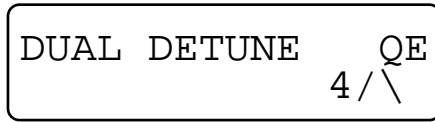

You can set the detune to any value between 0 (no detuning) and 7 (maximum detuning). Moving the slider upwards increases the detune value. Conversely, moving the slider downwards decreases the detune value.

**NOTE**

In this case you cannot use the [-1/NO] and [+1/YES] buttons to change data.

2. Release the [DETUNE] button.  
After a moment, the Dual voice names will reappear in the screen.

If you select different Dual voices, the detune relationship will remain the same as determined above, until you change the detune setting again.

● Main and Sub Voice Detune Relationship

When you detune two voices in Dual mode, the main voice is raised above the keyboard's standard pitch by a certain amount and the sub voice is lowered below the keyboard's standard pitch by an equal amount. The result is that the individual characteristics of each Dual voice are emphasized. The amount of pitch adjustment depends on the value you select. At the maximum detune setting, the voices are each detuned by about one-third of a semitone.

## ■ Split Mode

When the P-150 is in Split mode, you can play two voices at the same time—one voice on the left side of the keyboard, and another voice on the right side of the keyboard. For example, you can play a strings pad with one hand, while playing a piano melody with the other; or you can play an electric bass line with your left hand, while playing an organ riff with your right hand.

The two voices you play in Split mode are referred to as the main and sub voices. These voices are assigned to separate areas of the keyboard, known as the main and sub keyboard areas, which are separated at a specific key known as the split point.

You can determine the split point and assign the main and sub voices to either end of the keyboard. You can also adjust the volume balance of the two voices in relation to each other (for details, see page 30.)



## ENTERING AND EXITING SPLIT MODE

Press the [SPLIT] button.

When you press the [SPLIT] button, the LED above it will light, and the keyboard will split into two areas, one playing the main voice you selected in Single or Dual mode, and the other playing the voice which was last selected as the Split mode sub voice. (ELECTRIC BASS is the default sub voice designated at the factory.)



The current split point designation and keyboard area assignments briefly appear in the screen.

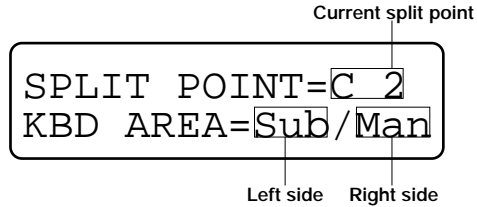

The first line of the above screen indicates that the current split point area is designated at key C2 (the initial default setting). The second line indicates that the sub voice is assigned to the left side of the split point, while the main voice is assigned to the right side of the split point.

After a few moments, the names of two voices will appear in the LCD screen.

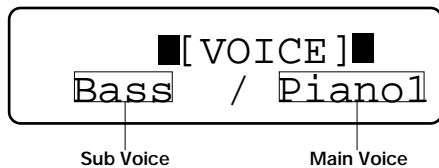

The P-150 will now play the two voices using the current split point designation and keyboard area assignments.

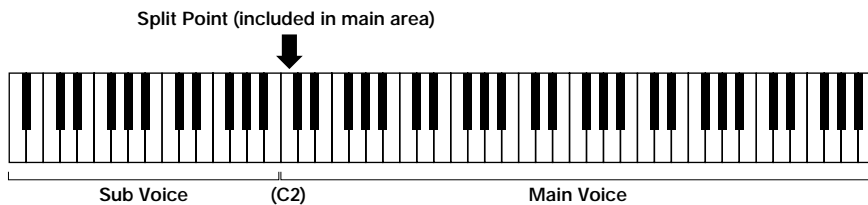

To exit Split mode, simply press the [SPLIT] button again. The P-150 will return to Single or Dual mode, depending on which one was active before you entered Split mode, playing the voice you have selected as the main voice.

### NOTE

If you enter Split mode directly from Dual mode, and then choose the Organ 1 voice as the main voice, when you press the [SPLIT] button to exit Split mode, the P-150 will automatically switch to Single mode.

### NOTE

In Split mode, the [PITCH] and [MODULATION] wheels, as well as the sustain, soft and sostenuto pedals, will only affect the main voice.

## SELECTING SPLIT VOICES

1. Main Voice: Press a [VOICE SELECT] button.
  - When you press the [SPLIT] button to enter Split mode, the voice you were playing in Single mode (or the main voice you were playing in Dual mode) will be assigned by default to the main keyboard area.

To change the main voice, simply press any [VOICE SELECT] button, the same as you would in Single mode.

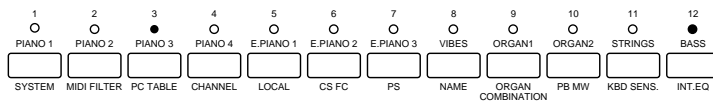

2. Sub Voice: Hold the [SPLIT] button and press a [VOICE SELECT] button.
  - Note that you can assign the same voice to both main and sub keyboard areas. This is useful in such cases where you want to use the same voice on each end of the keyboard, but with different Transpose settings (for details, see page 33), or at different volume balance levels.

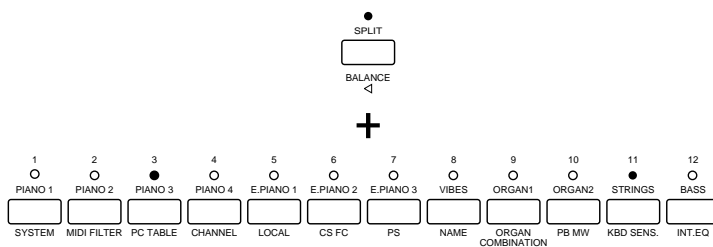

You'll find it convenient that the procedure for selecting voices is separate from that for entering and leaving Split mode, since this lets you switch the sub keyboard area on and off as needed. For example, you can play the main voice in Single Play mode (or Dual voices) across the entire keyboard during a song's verse and chorus, then switch into Split mode to add the sub voice for an intricate two-part solo, then switch the Split mode off to play remaining verses and choruses.

## ADJUSTING THE BALANCE OF THE SPLIT VOICES

1. Hold the [BALANCE] button and move the [DATA ENTRY] slider.
  - As you move the [DATA ENTRY] slider, the SPLIT BALANCE screen appears.

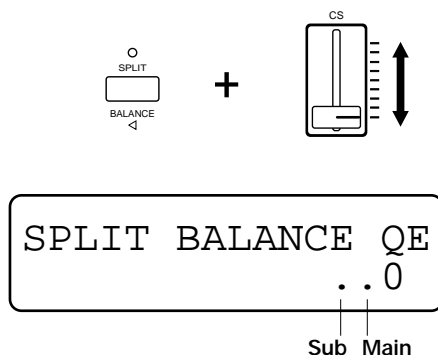

Moving the slider upwards increases the level of the main voice while decreasing the level of the sub voice. Conversely, moving the slider downwards increases the level of the sub voice while decreasing the level of the main voice. You can set the balance to any value between -16 and 15. Two indicators to the right of the numeric value display the relative balance of sub and main voices.

**NOTE**

In this case you cannot use the [-1/NO] and [+1/YES] buttons to change data.

2. Release the [BALANCE] button.  
After a moment, the Split voice names will reappear in the screen.

If you choose different Split voices, the balance relationship will remain the same as determined above, until you change the balance setting again.

## CHANGING THE SPLIT POINT

1. Hold the [SPLIT] button and press a key on the keyboard.  
The key that you press will become the new split point. The SPLIT POINT screen appears.

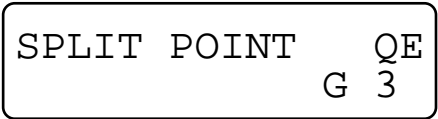
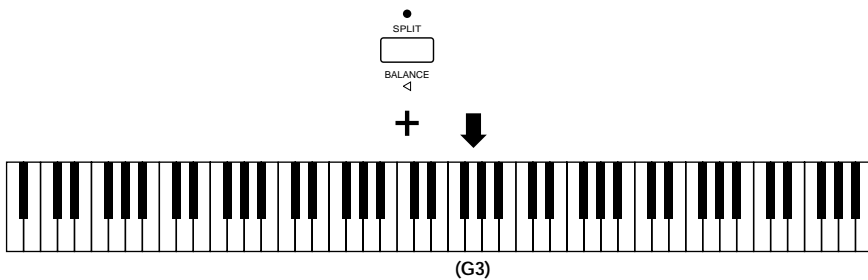

As long as you hold the [SPLIT] button, the note name of the key that you pressed will blink; pressing another key will change the split point still again, and the name of the new split point will likewise appear in the screen.

You can also raise or lower the current split point setting one semitone at a time by holding the [SPLIT] button and pressing the [-1/NO] or [+1/YES] buttons.

VOICE PLAY MODE

2. Release the [SPLIT] button.  
After a moment, the Split voice names will reappear in the screen.

The split point will remain where you set it until you change it again, even if you exit and reenter Split mode.

As you change the split point you can specify whether the main voice will play above or below the split point.

In general, the main keyboard area is normally above the split point; however, there may be cases when you'll want to play the main voice below the split point. For example, say you're playing a song where the verses and choruses call for a piano in the bass and strings on top, and an instrumental part calls for a piano solo that sweeps from one end of the keyboard to another. You can do this by selecting the piano as the main voice and assigning it to the lower keyboard area. You will then be able to switch from Split mode for the verses and choruses to Single mode for the solo, then back to split mode again, simply by pressing the [SPLIT] button.

## CHANGING MAIN AND SUB KEYBOARD AREAS

1. Hold the [SPLIT] button, then press and hold the split point key.
2. Press a second key below or above the split point key. The SPLIT AREA screen appears.



As you hold the [SPLIT] button and split point key, pressing a second key below the split point will designate the left area of the keyboard as the main area. Pressing a second key above the split point will again designate the right area of the keyboard as the main area.

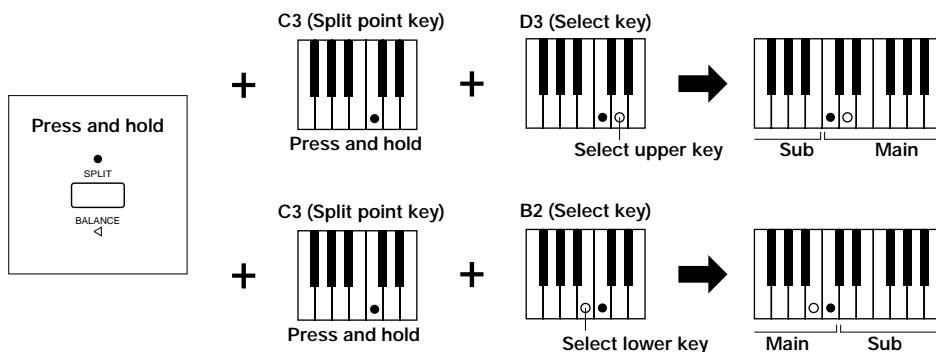

Note that the key that you press to select the split point will always be included in the main keyboard area. Thus, if you select F4 as the split point and then set the main keyboard area below this point, the main voice will play all notes up to and including F4, whereas the sub voice will play all notes from F#4 on. If you set the main keyboard area above this point, however, the sub voice will play all notes up to E4, and the main voice will play all notes from F4 on.

### NOTE

When you select voices in Split mode, the P-150 will apply the main voice reverb type and depth setting and modulation type and speed setting to both voices, and ignore any settings which you may have made for the sub voice. (For more information about main and sub voices, see page 25.)

# ■ Transpose

The P-150 has a multi-faceted transpose feature that lets you transpose the pitch at the touch of a button while you play.

The P-150 has four independent transpose paths, which let you set transpose values for the internal main voice as well as the sub voice, and which also let you set transpose values for the MIDI main and sub voices which will affect external devices.

Transpose is particularly useful in the Dual and Split modes. In the Dual mode, for example, you can play two different voices at the same time, each having a different pitch.

The P-150's default main voice transpose setting is 12, which means the pitch will transpose up one octave when you press the [TRANSCOPE] button. The default sub voice transpose amounts are set to 0 for Dual and Split modes.

## USING THE TRANSCOPE FEATURE

1. Press the [TRANSCOPE] button to transpose the pitch of the keyboard.
  - The LED above the [TRANSCOPE] button lights and the TRANSCOPE screen with current transpose value appears.



Depending on the current status and mode, the TRANSCOPE screen will be different. For example, if the P-150 is in Split mode and the MIDI transmit switch is enabled, the screen will display internal and MIDI main and sub voice transposition values.

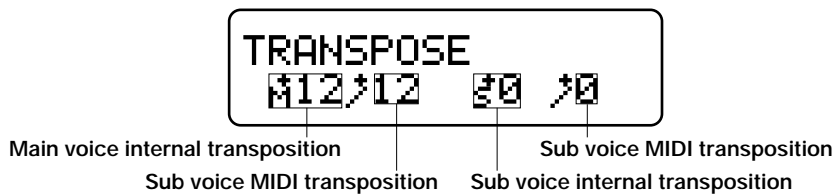

As you play in Split mode, the pitch of both voices will transpose according to main and sub voice settings when you press the [TRANSPPOSE] button. You can play two-handed duets with different instruments by transposing the sub voice up or down two octaves to match the pitch range of the main voice.

If the P-150 is in Dual mode and the MIDI transmit switch is enabled, the TRANSPOSE screen will display internal and MIDI main voice and internal sub voice transposition values.

As you play in Dual mode, the pitch of both voices will transpose according to independent main and sub voice settings when you press the [TRANSPPOSE] button. Thus, you can create two-note harmonies by lowering the sub voice so that it plays a fifth or an octave below the main voice.

If the P-150 is in Single mode and the MIDI transmit switch is enabled, the TRANSPOSE screen will display internal and MIDI main voice transposition values.

As you play in Single mode, the pitch of the entire keyboard will transpose according to the main voice setting when you press the [TRANSPPOSE] button. (The sub voice is not active in Single mode.)

If the MIDI transmit switch is disabled, only the main voice (and sub voice, depending on mode) transposition value will be displayed.

2. Press the [TRANSPPOSE] button again to return the keyboard to normal pitch. The LED above the [TRANSPPOSE] button goes out and the keyboard returns to normal pitch.

## SETTING THE TRANSPOSE AMOUNT

1. When the transpose function is on, hold the [TRANSPPOSE] button and press a key on the keyboard.

The key that you press becomes the new transpose amount. The TRANSPOSE screen appears.

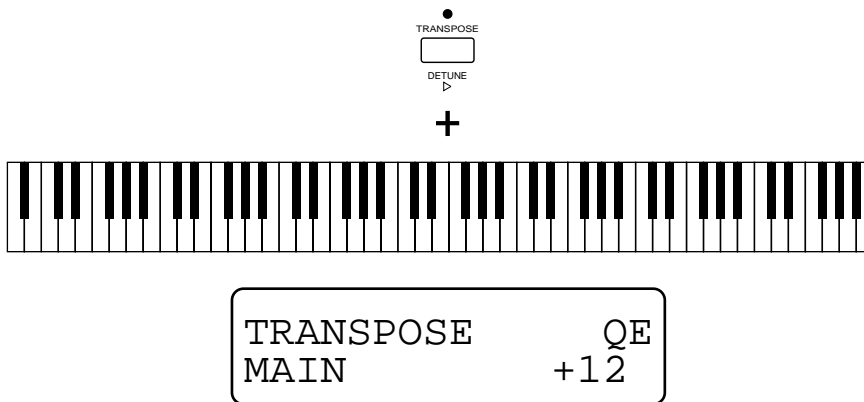

C3 (middle C) is the normal pitch, or 0 value, so all you need to do is press any key above or below C3 to set the transpose amount. For example, if you want the transpose amount to be one octave below normal keyboard pitch, simply press C2. To return the transpose amount to normal pitch, simply press C3 again.

**NOTE**

In this case you cannot use the [CS] slider to change the transpose value. (Trying to do so in Dual mode will activate the detune function.)

You can also change the transpose amount setting one semitone at a time by holding the [TRANSCOPE] button and pressing the [-1/NO] and [+1/YES] buttons.

**NOTE**

When the transpose setting exceeds the legal range (A-1 ~ C7) the P-150 plays and repeats the one octave higher (or lower) range. Also note that MIDI notes will not be transmitted if the data exceeds MIDI note values 0 ~ 127.

You can set the transpose amount anywhere within a range of four octaves, from -24 (C1) to 24 (C5). If you try to set the transpose amount by pressing a key below C1 or above C5 on the keyboard, the P-150 will react as though you pressed C1 or C5.

2. Release the [TRANSCOPE] button. The P-150 will assume that you want to transpose using this value, and leave the transpose function turned on after you complete the setting.

In a similar way, internal sub voice and MIDI transpose signals for the MIDI main and sub voice can be set independently, as explained below.

**INTERNAL SPLIT SUB VOICE:** To set the transpose value for the internal split sub voice, in Split mode, press and hold [TRANSCOPE], then hold [SPLIT], then press a key on the keyboard (or press the [-1/NO] or [+1/YES] buttons).

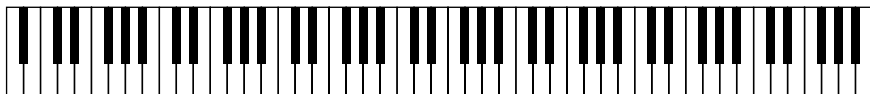
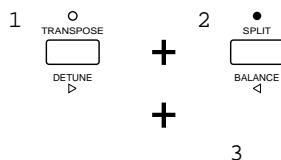

TRANSCOPE	QE
SPLIT SUB	+12

**INTERNAL DUAL SUB VOICE:** To set the transpose value for the internal dual sub voice, in Dual mode, press and hold [TRANSCOPE], then hold [SPLIT], then press a key on the keyboard (or press the [-1/NO] or [+1/YES] buttons).

TRANSCOPE	QE
DUAL SUB	+12

VOICE PLAY MODE

**MIDI MAIN VOICE:** To set the transpose value for the MIDI main voice, press and hold [TRANSCOPE], then hold [MIDI], then press a key on the keyboard (or press the [-1/NO] or [+1/YES] buttons).

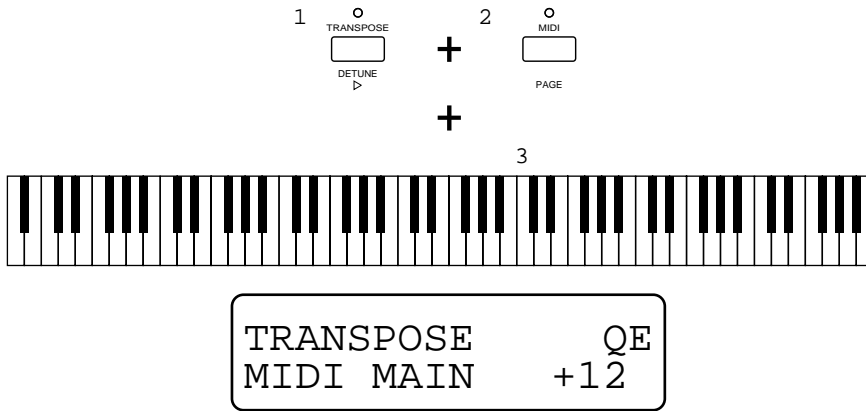

**MIDI SUB VOICE:** To set the transpose value for the MIDI sub voice, press and hold [TRANSCOPE], followed by [SPLIT], then [MIDI], then press a key on the keyboard (or press the [-1/NO] or [+1/YES] buttons).

**NOTE**

When changing the internal main or sub voice's transpose value, the MIDI main or sub voice will change accordingly.

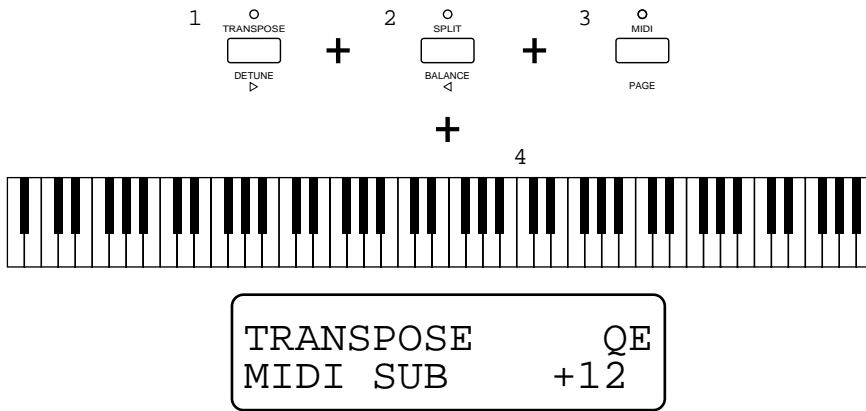

## ■ MIDI Transmit Enable

You can enable or disable MIDI transmission by pressing the [MIDI] button. The LED above the [MIDI] button remains lit while this function is enabled.



It will not block the reception of data from the [MIDI IN] jack.

Note that you cannot enable transmission if the [MIDI] button has been turned off.

Also note that setting (in Edit mode) the MIDI transmit channel to Off and setting all the MIDI Filters to On will have the same effect as disabling the MIDI transmit switch. The significance in this case is that turning the [MIDI] button off affects all of the Performances, whereas the aforementioned Edit mode settings can be assigned to individual Performances.

For details about the P-150's MIDI capabilities, see page 57.



## ■ MIDI Panic

Although MIDI is very reliable, it is in fact so sophisticated that it is not without its occasional faults. For example, sometimes a connected tone generator or synthesizer responds to a Note On message, but not a Note Off message, thus causing a note to get stuck, which can be quite frustrating, especially in a live performance setting.

Unexpected sustained notes, sudden losses of volume, and “hanging” pitch bends are also common MIDI problems that can happen when using a sequencer with the P-150 and other MIDI instruments.

The P-150’s MIDI Panic feature lets you instantly send note off and other messages to all connected MIDI devices.

### ACTIVATING MIDI PANIC

Hold the [MIDI] button, then press the [REVERB] and [MODULATION] buttons at the same time.

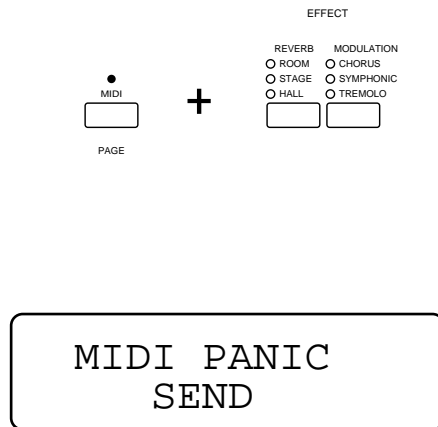

The MIDI PANIC SEND screen appears briefly when MIDI Panic is activated. When MIDI Panic is activated, the following messages are sent in sequence over all MIDI channels: All Notes Off; All Sounds Off; Channel Pressure off; Sustain Pedal Off; Modulation Off; Pitch Bend (Center); Reset All Controllers.

MIDI Panic has no effect during sending/receiving bulk data or while MIDI Merge is on.

# PERFORMANCE PLAY MODE

## ENTERING AND EXITING PERFORMANCE PLAY MODE

1. Press the [PERF. A] or [PERF. B] button.
  - If you press the [PERF. A] button, the LED above it will start blinking to indicate that the P-150 is standing by to enter the PERFORMANCE-A bank. Likewise, if you press the [PERF. B] button, the LED above it will start blinking to indicate that the P-150 is standing by to enter the PERFORMANCE-B bank.

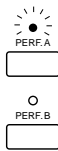

2. Press a [PERFORMANCE SELECT] button.
  - Pressing a [PERFORMANCE SELECT] button activates Performance mode. The LEDs above the [PERFORMANCE SELECT] and [PERF.] buttons light, and the name of the Performance appears in the LCD screen.

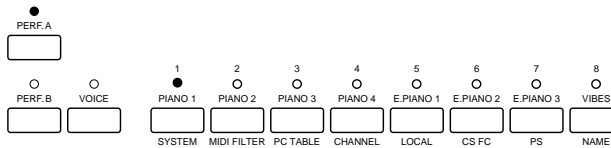

PERFORMANCE<A01>  
Piano 1

To exit Performance Play mode, simply press the [VOICE] button, followed by a [VOICE SELECT] button, which will return you to Voice Play mode.

## SELECTING A PERFORMANCE

Press a [PERFORMANCE SELECT] button.

Pressing any of the 12 [PERFORMANCE SELECT] buttons will access a Performance in the currently selected Performance bank. The name of the Performance appears in the LCD screen.

The P-150 comes with 24 Preset Performances designed for various musical purposes. Take a moment and try out each one in both A and B banks. For a list of the Preset Performances, see page 64.

Just as in Voice Play mode, Performance Play mode lets you select Single voices as well as activate Dual mode and Split mode.

## ■ Selecting Single Voices

Within Performance Play mode you can easily select Single voices in the current Performance. The procedure is slightly different than in Voice Play mode.

## SELECTING SINGLE VOICES IN PERFORMANCE PLAY MODE

Hold the [EDIT] button, then press a [VOICE SELECT] button. The name of the voice appears in the LCD screen.

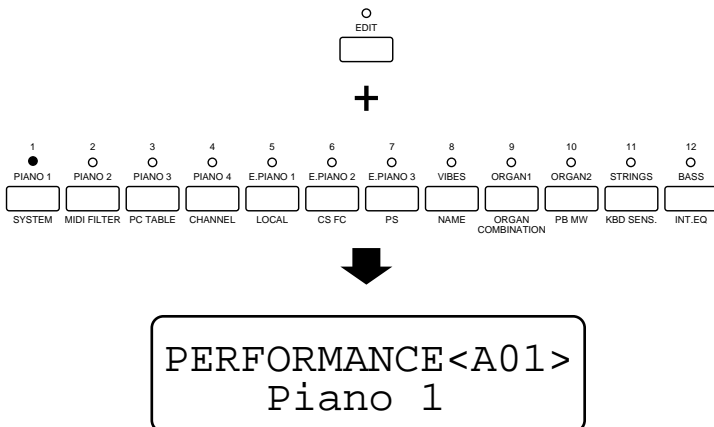

### NOTE

Only a single set of Voice parameters is available for each Performance. Therefore, the Voice parameters set for one voice will also be effective when you select other voices.

### NOTE

In Performance Play mode, a lit LED above a voice button does not indicate the selected voice(s). It indicates the currently selected performance.

## ■ Selecting Dual Voices

Within Performance Play mode you can easily select Dual voices in the current Performance. The procedure is slightly different than in Voice Play mode.

### SELECTING DUAL VOICES IN PERFORMANCE PLAY MODE

Hold the [EDIT] button, then press two [VOICE SELECT] buttons. This activates Dual mode from within Performance Play mode. The names of the voices appear in the LCD screen.

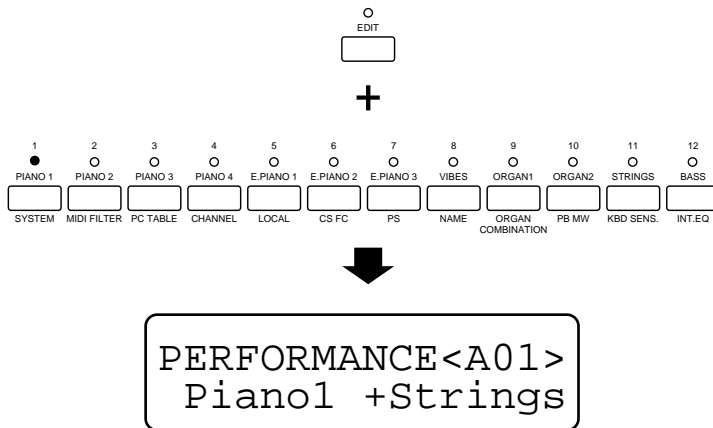

Note that the order in which you press the [VOICE SELECT] buttons determines the main and sub voices, just as in Voice Play mode. For details, see Dual Mode, page 26.

## ■ Selecting Split Voices

Within Performance Play mode you can easily select Split voices in the current Performance. The procedure is slightly different than in Voice Play mode.

### SELECTING SPLIT VOICES IN PERFORMANCE PLAY MODE

1. Press the [SPLIT] button.
  - This activates Split mode from within Performance Play mode. The names of the voices appear in the LCD screen.



2. Main Voice: Hold the [EDIT] button, then press a [VOICE SELECT] button.

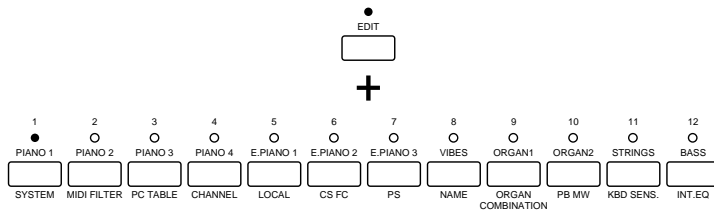

3. Sub Voice: Hold the [SPLIT] button and press a [VOICE SELECT] button.

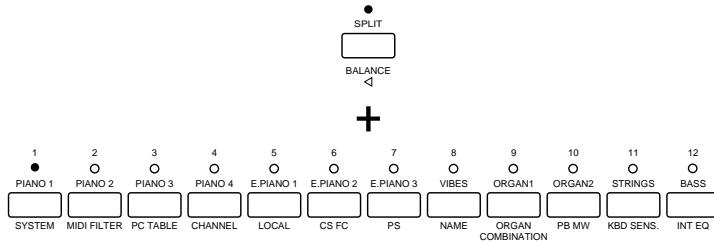

PERFORMANCE<A01>  
Bass / Piano1



# EDIT MODE

## ■ Edit Menu Tree

Edit mode lets you access and edit functions related to System parameters (1. ~ 3.), Performance parameters (4. ~ 9.) and Voice parameters (10. ~ 12. plus REVERB and MODULATION).

The Edit Menu Tree below outlines the Edit mode functions and pages. (Pages can be selected with the [PAGE] button or by pressing the specific [EDIT SELECT] button continually. Items marked with an asterisk\* can be selected using the [1]/[q] buttons.)

### SYSTEM MENUS

#### 1. SYSTEM

- Page 1.MASTER TUNE
- 2.REVERB
- 3.DEVICE NUMBER
- 4.MIDI MERGE
- 5.PERFORMANCE ENABLE
  - MIDI CHANNEL \*
  - LOCAL \*
  - CONTROLLER ASSIGN \*
- 6.POPUP TIME
  - PROGRAM CHANGE \*
  - OTHERS \*
- 7.STORE TYPE

#### 2. MIDI FILTER

- Page 1.TRANSMIT FILTER
  - MESSAGE TYPE \*
  - ON/OFF \*
- 2.RECEIVE FILTER
  - MESSAGE TYPE \*
  - ON/OFF \*

#### 3. PROGRAM CHANGE TABLE

- Page 1.PROGRAM CHANGE TRANSMIT
  - VOICE/PERFORMANCE NO. \*
  - MSB/LSB \*
  - PROGRAM CHANGE NUMBER \*
- 2.PROGRAM CHANGE RECEIVE
  - PROGRAM CHANGE NUMBER \*
  - VOICE/PERFORMANCE NO. \*

### PERFORMANCE MENUS

#### 4. CHANNEL

- Page 1.CHANNEL
  - TRANSMIT \*
  - RECEIVE \*

#### 5. LOCAL

- Page 1.LOCAL

#### 6. CONTINUOUS SLIDER(CS) / FOOT CONTROLLER(FC)

- Page 1.CS ASSIGN
- 2.CS RANGE
  - MIN/MAX \*
- 3.FC ASSIGN
- 4.FC RANGE
  - MIN/MAX \*

#### 7. PANEL SWITCH (PS)

- Page 1.PANEL SWITCH 1 ASSIGN
- 2.PANEL SWITCH 2 ASSIGN

#### 8. NAME

- Page 1.PERFORMANCE NAME
  - CHARACTER SELECT (16 characters) \*

#### 9. ORGAN COMBINATION

- Page 1.FOOTAGE
  - 8 FOOTAGE TYPES \*
- 2.RESPONSE, ATTACK
  - RESPONSE, 3 ATTACK TYPES, ATTACK LENGTH/MODE \*

### VOICE MENUS

#### 10. PITCH BEND (PB)/MODULATION WHEEL (MW)

- Page 1.PB RANGE
- 2.MW ASSIGN

#### 11. KEYBOARD SENSITIVITY

- Page 1.KEYBOARD SENSITIVITY INTERNAL
- 2.KEYBOARD SENSITIVITY MIDI
- 3.KEYBOARD RANGE
  - MIN/MAX \*

#### 12. INTERNAL EQUALIZER

- Page 1.EQ
  - LOW \*
  - MID \*
  - HIGH \*

#### REVERB

- Page 1.REVERB TYPE
  - TYPE \*
  - DEPTH \*

#### MODULATION

- Page 1.MODULATION TYPE
  - TYPE \*
  - SPEED \*

## NOTE

The Edit function page numbers appear in the upper right corner of the screen. When Non Auto Store is selected and Edit mode is engaged, the letter S, P or V will appear to the right of the page number to indicate which type of parameters you are editing System, Performance or Voice parameters, respectively.

MASTER TUNE 1s  
440.0Hz

## NOTE

Channel, Local, CS FC and PS settings are basically classified as Performance parameters, though they are treated as System parameters when Sys is selected for MIDI Channel, Local or Controller Assign in the Performance Enable function (System Menu), see page 45. When Sys has been selected, the letter S will appear to the right of the page number, replacing the letter P.

LOCAL 1s  
on

## ENTERING AND EXITING EDIT MODE

Press the [EDIT] button.

The LED above the [EDIT] button starts blinking, as does the LED above the [EDIT SELECT] button which was active the last time you exited Edit mode. The name of the currently active parameter page appears in the LCD screen.

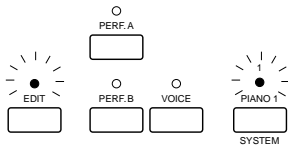

MASTER TUNE 1  
440.0Hz

Each of the 12 [EDIT SELECT] buttons is dedicated to one or more Edit functions, as indicated by a name printed in green below each button.

To exit Edit mode, simply press the [EDIT] button again, which returns you to the previous Play mode.

## SELECTING AN EDIT FUNCTION

Press an [EDIT SELECT] button.

The LED above the button you press starts blinking, and the name of the currently active parameter page appears in the LCD screen.



MASTER TUNE 1  
440.0Hz

## SELECTING EDIT FUNCTION PAGES

Press the [PAGE] button once or more.

Each time you press the [PAGE] button a page will appear in the LCD screen.



You can also select Edit function pages by pressing the same [EDIT SELECT] button once or more. For example, if you select the System function, you can simply press the [SYSTEM] button as many times as necessary to access the System function page you want.

POPUP TIME 6  
PC=off OTHERS= 3

The name of each page, as well as the accessible parameters within it, appears in the LCD screen as you step through the pages.

## EDITING PARAMETERS

Note that some pages contain several parameters, which you can access with the cursor buttons. (See asterisk\* items on the Edit Menu Tree, page 42.)

1. If necessary, press the [<] or [>] buttons to position the cursor over the desired parameter.

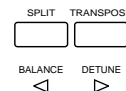

The currently selected parameter will blink on and off in the LCD screen.

POPUP TIME 6  
PC=off OTHERS= 3

## 2. Change the parameter using the [-1/NO] and [+1/YES] buttons, or by moving the [DATA ENTRY] slider up or down.

Parameters may consist of numeric values or specific settings which you can select.

If the P-150 is in Auto Store status, the changes you make will be stored automatically in the current location. If the P-150 is in Non Auto Store status, when you change a parameter and press the [EDIT] button to exit Edit mode, the STORE? confirmation screen appears.

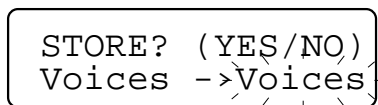

In this case you will need to store the current Performance by either overwriting it in its current location, or copy it in another Performance bank and number.

### NOTE

Regardless of the Auto Store/Non Auto Store status, the parameter changes made in the System menu (System, MIDI Filter, PC Table) are always stored automatically. (For details about store functions, see page 53.)

## System

System parameters which you can select and edit include Master Tune, Reverb Bypass, Device Number, MIDI Merge, Performance Enable, Popup Time, and Store Type.

### MASTER TUNE

The Master Tune function lets you fine-tune the basic pitch of the keyboard.

As an electronic instrument, the P-150 is set to optimum tuning at the factory, with a default pitch value of 440.0 Hz at A3. You can, however, fine-tune the P-150's keyboard upward or downward within a range of about 100 cents.

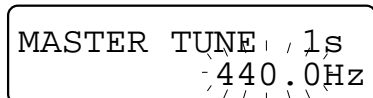

- MASTER TUNE (424.0Hz~440.0~456.3Hz)  
You can change the master tuning between 424.0Hz and 456.3Hz.

### REVERB

The Reverb Bypass function lets you disengage the reverb effect. You will find the Reverb Bypass useful to disengage the P-150's internal DSP when you want to use an external effector.

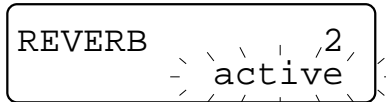

- ACTIVE  
When the Active setting is selected, the P-150's on-board reverb effects will function as normal.
- BYPASS  
When the Bypass setting is selected, the P-150's on-board reverb effects will be disengaged.

### DEVICE NUMBER

The Device Number function lets you match the MIDI device number with the device number of an external instrument. This is necessary when transmitting and receiving bulk data and parameter change data.

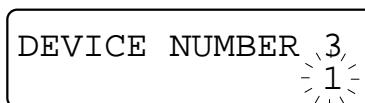

- OFF  
When set to Off, the P-150 will ignore incoming MIDI device number messages.
- 1 ~ 16  
When a specific MIDI device number is selected, the P-150 will only receive bulk data on the corresponding MIDI device number.
- ALL  
When set to All, the P-150 will receive bulk data on any device number. (When set to All, the P-150 will transmit on device number 1.)

### MIDI MERGE

The MIDI Merge function lets you merge all data received at the [MIDI IN] terminal with the data generated by the P-150, for combined transmission at the [MIDI OUT] terminal.

Instruments which receive merged MIDI data from the P-150 can be controlled by the P-150 as well as other devices connected to the P-150's [MIDI IN] terminal.

Note that when performing bulk dump operations, the MIDI



Merge function must be turned off. For details, see page 55.

- OFF  
When set to Off (default), only internal MIDI data will be transmitted from the P-150's [MIDI OUT] terminal.
- ON  
When set to On, any MIDI data received at the [MIDI IN] terminal will be transmitted as is from the [MIDI OUT] terminal together with data transmitted by the P-150.



## PERFORMANCE ENABLE

The Performance Enable function lets you switch between System (“Sys”) settings and Performance (“Perf”) settings for MIDI channel assignments, local on/off status and controller assignments. This function lets you apply the System settings designated in Voice Play mode to all of the Performances.

### ● PERFORMANCE MIDI CHANNEL (Perf, Sys)

When Perf is selected, the MIDI transmit and receive channels designated for the currently selected Performance will be effective. When Sys (default) is selected, the MIDI transmit and receive channels designated for the Voice Play mode will affect the entire system.

```
PERF, MIDI CH 5
  SYS / SYS / SYS
```

### ● PERFORMANCE LOCAL (Perf, Sys)

When Perf is selected, the Local On/Off setting designated for the currently selected Performance will be effective. When Sys (default) is selected, the Local On/Off setting designated for the Voice Play mode will affect the entire system.

```
PERF. LOCAL 5
  SYS / SYS / SYS
```

### ● PERFORMANCE CONTROL (Perf, Sys)

When Perf is selected, the controller assignments designated for the currently selected Performance will be effective. When Sys (default) is selected, the controller assignments designated for the Voice Play mode will affect the entire system.

```
PERF. CTRL. 5
  SYS / SYS / SYS
```

## POPUP TIME

The Popup Time function lets you set the number of seconds a temporary message displays in the screen.

The P-150 has a number of messages which appear in the screen depending on which feature you access. By setting the Popup Time, you can determine how long the message stays in the screen.

You can also set the Program Change message screen to temporarily display when you change voices or Performances.

### ● PC (OFF, 1 ~ 5)

You can either turn the Program Change popup screen off or have it display between one and five seconds. (The default setting is Off.)

```
POPUP TIME 6
PC=off OTHERS= 3
```

### ● OTHERS (1 ~ 5)

You can have all other popup screens display between one and five seconds. (The default setting is 3.)

```
POPUP TIME 6
PC=off OTHERS= 3
```

## STORE TYPE

The Store Type function lets you designate Auto Store or Non Auto Store status. (For information about storing, see page 53.)

```
STORE TYPE 7
  - auto store -
```

### ● NON AUTO STORE

In Non Auto Store (default) status, only System, MIDI Filter and PC Table parameters you change will automatically be stored. Any other changes in Edit mode will cause the STORE? (YES/NO) screen to display to prompt you for confirmation before exiting the Edit mode. Any other changes made in Voice Play mode and Performance Play mode will be ignored unless you specifically perform the store operation.

### ● AUTO STORE

In Auto Store status, all settings you change will automatically be stored.

#### NOTE

When Non Auto Store is selected and Edit mode is engaged, the letter S, P or V will appear to the right of the page number in the upper right hand corner to indicate which type of parameters you are editing System, Performance or Voice parameters, respectively.

#### NOTE

Channel, Local, CS FC and PS settings are basically classified as Performance parameters, though they are treated as System parameters when Sys is selected for MIDI Channel, Local or Controller Assign in the Performance Enable function (System Menu); see left. When Sys has been selected, the letter S will appear to the right of the page number, replacing the letter P.

## ■ MIDI Filter

The MIDI Filter function lets you select the various types of MIDI data which will be transmitted or received. (Note: The abbreviation "TX" stands for "Transmit" and the abbreviation "RX" stands for "Receive".) Position the cursor over the Message type or on/off status using the [1] and [c] buttons.

### TRANSMIT FILTER

The Transmit Filter settings let you determine which types of MIDI messages are transmitted from the P-150.

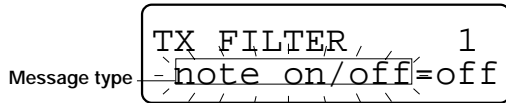

#### ● MESSAGE TYPES

Message types include Note On/Off, Control Change, Program Change, Aftertouch, Pitch Bend, Channel Mode Message, Parameter Change and Bulk and FA/FB/FC. (Select the message types with the [-1/NO] and [+1/YES] buttons.)

#### ● ON, OFF

Setting the message type to On status will filter this particular data, and therefore it will not be transmitted via the [MIDI OUT] terminal. Setting the message type to Off status will allow the particular data to be transmitted.

#### NOTE

The default setting for Parameter Change is set to On; all others are set to Off. When controlling external devices such as a tone generator, Exclusive and Bulk should be set to On. When you record your P-150 Performance to an external sequencer and play it back, Exclusive and Bulk should be set to Off.

### RECEIVE FILTER

The MIDI Receive Filter settings let you determine which types of incoming MIDI messages are received. When set to On, the specific data can be protected.

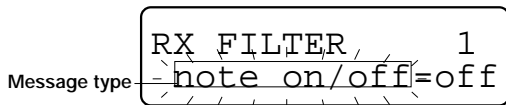

#### ● MESSAGE TYPES

Message types include Note On/Off, Control Change, Program Change, Pitch Bend, Channel Mode Message, Parameter Change and Bulk. (Select the message types with [-1/NO] and [+1/YES] buttons.)

#### ● ON, OFF

Setting the message type to On status will filter this particular data, and therefore it will not be received at the [MIDI IN] terminal. Setting the message type to Off status will allow the particular data to be received.

## ■ Program Change (PC) Table

The Program Change Table function lets you assign program change numbers to incoming and outgoing program change messages.

### PROGRAM CHANGE TRANSMIT

The Program Change Transmit function lets you assign program change transmit numbers to each voice or Performance. You can also assign bank numbers (MSB/LSB) as bank select messages.

Your P-150 can transmit a program change message each time you press a [SELECT] button in Voice or Performance mode. (You can have the number of the program change message display briefly when you select a voice or Performance. For details, see page 45.)

At the factory your P-150 was preset so that each [SELECT] button will send the program change number corresponding to the number above the button in Voice mode (1 ~ 12), followed by subsequent numbers in Performance mode, for A and B banks (13 ~ 36).

Therefore, when the P-150 is in Voice mode, an external tone generator connected to the P-150 will receive messages selecting program 1 when you press the [PIANO 1] button, program 2 when you press the [PIANO 2] button, and so on. When the P-150 is in Performance mode and bank A is selected, an external tone generator will receive messages selecting program 13 when you press [PIANO 1]. Likewise, when bank B is selected, program 25 will be selected when you press [PIANO 1].

The settings for which program change number is assigned to which [SELECT] button are grouped in a table known as the program change transmit table, which you can access to assign a program change number (between 1 and 128, or Off) to each of the [SELECT] buttons according to Play mode.

You can also select a bank number combining the MSB (Most Significant Byte) and LSB (Least Significant Byte). This makes it possible to select any program on a MIDI device that has more than 128 programs.

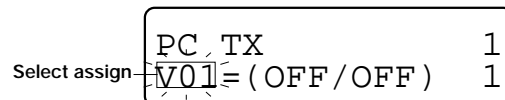

#### ● SELECT ASSIGN (V01~V12, A01~A12, B01~B12)

These parameters let you access each [SELECT] button, with V01 ~ V12 representing the Voice Play mode [VOICE SELECT] buttons, and A01 ~ A12 representing the Performance Play mode A bank [PERFORMANCE SELECT] buttons, and B01 ~ B12 representing the Performance Play mode B bank [PERFORMANCE SELECT] buttons. As you step through each one, the name will appear in the first line of the screen, and the current assignments will appear in the second line.

#### NOTE

You can choose a specific Voice button number by holding [VOICE] and pressing the desired [VOICE SELECT] button. You can choose a specific Performance A bank button number by holding [PERF. A] and pressing the desired [PERFORMANCE SELECT] button. You can choose a specific Performance B bank button number by holding [PERF. B] and pressing the desired [PERFORMANCE SELECT] button.

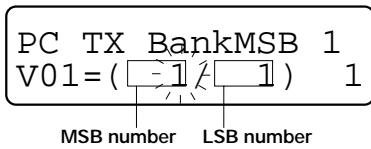

● MSB/LSB (Off, 0 ~ 127)

This parameter lets you designate the MSB/LSB bank select number. When set to Off (default), the P-150 will not transmit the bank select number.

**NOTE**

Pressing the [-1/NO] button lets you select Off for MSB/LSB and Program Change Number. When Off is selected for MSB, LSB will also switch off, and vice-versa.

Bank Select (PC Table)

BANK	PROGRAM	MSB	LSB
Bank 1	1 ~ 128	1	1
Bank 2	1 ~ 128	1	2
Bank 3	1 ~ 128	1	3
Bank 4	1 ~ 128	1	4
“	“	“	“
“	“	“	“

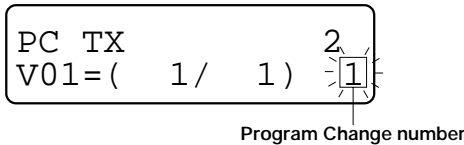

● PROGRAM CHANGE NUMBER (Off, 1 ~ 128)

This parameter lets you designate the program change number for the currently accessed [SELECT] button. When set to Off, no program change numbers will be transmitted.

## PROGRAM CHANGE RECEIVE

The Program Change Receive function lets you assign program change receive numbers to the internal voices and Performances, according to the [SELECT] buttons.

The P-150 can receive a program change message from an external MIDI device, in order to select any of the 12 voices or 24 Performances.

At the factory your P-150 was preset so that each [SELECT] button will receive the program change number message corresponding to the number above the button in Voice mode (1 ~ 12), followed by subsequent numbers in Performance mode, for A and B banks (13 ~ 36).

Therefore, when the P-150 is in Voice mode, when an external controller connected to the P-150 sends a program change number 1 message, the PIANO 1 voice will be selected; if it sends a program change number 2 message, the PIANO 2 voice will be selected, and so on. If it sends a program change number 13 message, Performance A01 will be selected; if it sends a program change number 25 message, Performance B01 will be selected, and so on.

Whenever the P-150 receives a program change message, it will check the program change receive table to determine whether a voice or Performance has been assigned to the Received program change number. If so, the main voice will automatically switch to the voice indicated by the program change receive table. (If the P-150 is in Dual mode, this will cause it to shift to Single mode.) If the program change function has been turned off for that number the message will simply be ignored.

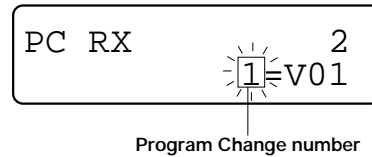

● PROGRAM CHANGE NUMBER (1~128)

This parameter lets you designate a program change receive number. As you step through each one, the SELECT assignment will appear to the right.

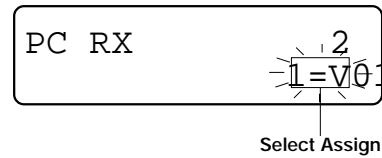

● SELECT ASSIGN

(V01~V12, A01~A12, B01~B12, Off)

This parameter lets you assign which [SELECT] button to assign to the currently designated Program Change Number.

**NOTE**

You can choose a specific Voice button number by holding [VOICE] and pressing the desired [VOICE SELECT] button. You can choose a specific Performance A bank button number by holding [PERF. A] and pressing the desired [PERFORMANCE SELECT] button. You can choose a specific Performance B bank button number by holding [PERF. B] and pressing the desired [PERFORMANCE SELECT] button.

**NOTE**

Pressing the [-1/NO] button lets you select Off for Program Change Number and Select Assign.

## Channel

The Channel function lets you assign the P-150's MIDI transmit and receive channel numbers or status.

When connecting the P-150 to an external MIDI device, such as a multitimbral tone generator or synthesizer, you will need to set the P-150's transmit channel to the same number as the external device's receive channel, in order to play the external instrument with the P-150's keyboard. Likewise, you will need to set the P-150's receive channel to the same number as an external keyboard's transmit channel in order to play the P-150's internal voices from an external keyboard. (For more information, see Using MIDI, page 57.)

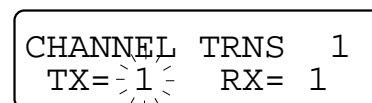

● TRANSMIT CHANNEL (Off, 1 ~ 16)

The P-150 can be set to transmit MIDI messages on any one of 16 MIDI channels. When set to Off the P-150 will not transmit MIDI messages.

● RECEIVE CHANNEL (Off, 1 ~ 16, All)

The P-150 can be set to receive MIDI messages on any one of 16 MIDI channels. When set to Off, all incoming MIDI messages will be ignored. When set to All, MIDI messages can be received on all 16 channels at once. In Dual and Single modes, all channel messages will be transmitted via the channel specified here. In Split mode, the main voice will be transmitted via the channel specified here and the sub voice will be transmitted via the next highest channel number than the main voice.

**NOTE**

When you set the transmit channel to Off, the MIDI transmit button will be disabled for the currently selected Performance.

**NOTE**

If you select Sys for MIDI CHANNEL in the Performance Enable function (System menu), the MIDI transmit/receive channel you have previously set for the currently selected Performance may actually be different, since the current setting (System setting) in the Voice Play mode will be active. You can change the System setting, and you can easily find which setting (Sys or Perf) is selected in the Performance Enable function, as the letter P will display to the left of the page number if Perf is selected.

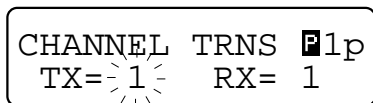

■ Local

The Local control function lets you disconnect the P-150's keyboard from its internal tone generator.

It is usually turned on so the internal voices will sound when you play the keyboard. When turned off, the internal tone generator will not respond to the notes you play, but the keyboard will still transmit messages via the [MIDI OUT] terminal, and the internal tone generator will respond to messages received at the [MIDI IN] terminal if the transmit channels or receive channels are appropriately set. This is essential when using the P-150 as a master keyboard controller in an expanded MIDI system.

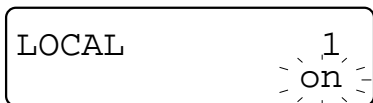

● LOCAL (On, Off)

When set to On, the internal tone generator will respond to notes you play on the P-150's keyboard. When set to Off, the internal tone generator will not respond to notes you play on the P-150's keyboard.

**NOTE**

If you select Sys for LOCAL in the Performance Enable function (System menu), the Local On/Off setting you have designated previously for the currently selected Performance may actually be different, since the current setting (System setting) in the Voice Play mode will be active. You can change the System setting, and you can easily find which setting (Sys or Perf) is selected in the Performance Enable function, as the letter P will display to the left of the page number if Perf is selected.

■ Continuous Slider (CS) / Foot Controller (FC)

This function lets you assign a function and range to the [CS] and [FC] assignable continuous controllers, for realtime control during performance of the P-150 and/or an external MIDI device.



Once you assign a function to the [CS], the function will be controlled by the [CS] slider on the panel. Once you assign a function to the [FC], the function will be controlled by the Foot Controller, if it is properly connected to the [FOOT CONTROLLER] jack on the rear panel. The Yamaha FC-7 Foot Controller (continuous type) and FC4/FC5 Footswitch (on/off; discrete type) are optionally available.

For example, you can have the [CS] (or [FC]) control the total volume, main or sub voice volume, or control the reverb depth or modulation speed, or transmit aftertouch messages to tone generators capable of receiving them, or send a particular type of control change message to external MIDI devices. The types of functions which can be assigned, and a brief explanation of each, are shown in the following chart.

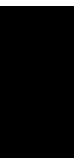

EDIT MODE

## INTERNAL CONTROL

Off	No function assigned
Reverb Depth	Controls the reverb depth level
Mod. Speed	Controls the modulation speed level
Total Volume	Controls the P-150's overall volume
Main Volume	Controls the main voice volume
Sub Volume	Controls the sub voice volume

## MIDI CONTROL CHANGE MESSAGES

Modulation	001	Sends a modulation message
Breath Control	002	Sends a breath control message
Foot Control	004	Sends a foot control message
Porta. Time	005	Sends a portamento time message
Data Entry	006	Sends a data entry message
Volume	007	Sends a volume message
Balance Control	008	Sends a balance control message
Panpot	010	Sends a stereo panning message
Expression	011	Sends a volume expression message
Sustain	064	Sends a sustain message
Portamento Sw	065	Sends a portamento switch message
Sostenuto	066	Sends a sostenuto message
Soft Pedal	067	Sends a soft pedal message
Legato Foot	068	Sends a legato foot message
Hold 2	069	Sends a hold 2 message (such as "freezing" the operation of a synthesizer's envelope until the Footswitch is released)
Harm. Content	071	Sends a harmonic content message
Release Time	072	Sends a release time message
Attack Time	073	Sends an attack time message
Brightness	074	Sends a brightness message
Eff. 1 Depth	091	Sends an effect 1 depth message
Eff. 2 Depth	092	Sends an effect 2 depth message
Eff. 3 Depth	093	Sends an effect 3 depth message
Eff. 4 Depth	094	Sends an effect 4 depth message
Eff. 5 Depth	095	Sends an effect 5 depth message
Inc. Sw	096	Sends an increment switch message
Dec. Sw	097	Sends a decrement switch message
NRPN LSB	098	Sends a Non Registered Parameter number LSB bank select message
NRPN MSB	099	Sends a Non Registered Parameter number MSB bank select message
RPN LSB	100	Sends a Registered Parameter Number LSB bank select message
RPN MSB	101	Sends a Registered Parameter Number MSB bank select message
Aftertouch		Sends a channel aftertouch message

### ● CONTINUOUS SLIDER ASSIGN (see chart)

For assigning a specific function to the CS. (Default is main volume.)

```
CS ASSIGN / / 1
main volume: 007
```

### ● CONTINUOUS SLIDER RANGE MINIMUM (1~128) / MAXIMUM (1~128)

The values set here determine the minimum and maximum volume range when you move the [CS] slider. (You cannot set the minimum number to exceed the maximum number.)

```
CS RANGE MIN 2
1#128
```

### ● FOOT CONTROLLER ASSIGN (see chart)

For assigning a specific function to the foot controller (FC). (Default is sub volume.)

```
FC ASSIGN / / 3
total volume
```

### ● FOOT CONTROLLER RANGE MINIMUM (1~128) / MAXIMUM (1~128)

The values set here determine the minimum and maximum volume range when you press the [FC] controller. (You cannot set the minimum number to exceed the maximum number.)

```
FC RANGE MIN 4
1#128
```

#### NOTE

If you select Sys for CONTROL in the Performance Enable function (System menu), the controller assignment you have previously set for the currently selected Performance may actually be different, since the current setting (System setting) in the Voice Play mode will be active. You can change the System setting, and you can easily find which setting (Sys or Perf) is selected in the Performance Enable function, as the letter P will display to the left of the page number if Perf is selected.

#### NOTE

The actual range (1 ~ 128) may actually be different depending on the selected function type. If the maximum range of the selected function is less than 128, the available range will be recognized and divided equally into 128 units, and the setting for Min/Max will be executed.

## ■ Panel Switch (PS)

The Panel Switch function lets you assign a function to each of the two Panel Switches for realtime control of an external MIDI sequencer.

This gives you the flexibility to send Start, Stop or Continue commands to external devices like sequencers and rhythm programmers from the P-150's panel, i.e., you can start and stop the external device simply by pressing the [PS] switches.

### ● PS1 ASSIGN (Off, Start, Continue, Stop)

When set to Off, the [PS1] will have no specific Play function. When set to Start, Continue or Stop, you can control an external MIDI device by pressing [PS1]. (The default setting for [PS1] is Start.)



### ● PS2 ASSIGN

Same as for PS1 ASSIGN, above. (The default setting for [PS2] is Stop.)

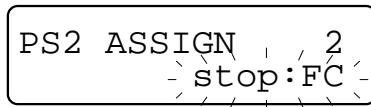

### NOTE

If you select Sys for CONTROL in the Performance Enable function (System menu), the Panel Switch assignment you have previously set for the currently selected Performance may actually be different, since the current setting (System setting) in the Voice Play mode will be active. You can change the System setting, and you can easily find which setting (Sys or Perf) is selected in the Performance Enable function, as the letter P will display to the left of the page number if Perf is selected.

## ■ Name

The Name function lets you input a name (up to 16 characters in length) for your Performances.



### ● PERFORMANCE NAME

The available characters include upper and lower case Roman letters, numbers 0 ~ 9, a space and various symbols. Position the cursor with the [1]/[q] buttons and choose the desired character with the [-1/NO]/[+1/YES] buttons or the [DATA ENTRY] slider.

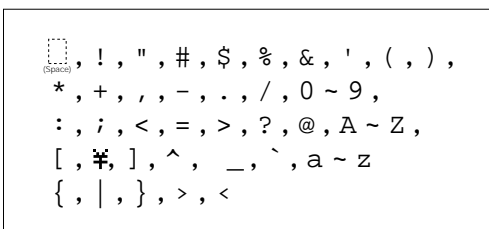

## ■ Organ Combination

The Organ Combination function lets you freely edit the Organ 1 voice. This feature gives you considerable control over the timbre and characteristics of the organ sound, so that the range of possibilities are practically limitless.

With this feature you can literally recreate all of the classic organ sounds, from theatre organ to rock and jazz organ, by adjusting the flute footage levels and the attack settings, just like on conventional organs.

To edit the organ sound, you must first select the Organ 1 voice before entering Edit mode. Otherwise the CANNOT EDIT message will display when you select the Organ 1 Combination function in Edit mode. (If this happens, simply exit Edit mode, select the Organ 1 voice, and then reenter Edit mode.)

### ● FOOTAGE (16', 8', 5-1/3', 4', 2-2/3', 2', 1-1/3', 1')

There are eight flute footages. The larger footages generate the bass characteristics of the sound, the smaller footages generate the treble characteristics of the sound, and those footages in between generate the mid-range characteristics of the sound. You can adjust the volume level of each flute footage between 0 (no volume) and 7 (maximum volume).

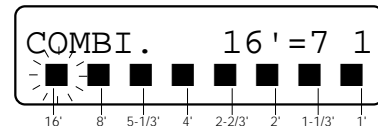

### NOTE

When only the lowest or highest footage is activated, some notes which exceeds the legal range will not produce any sound.

### ● RESPONSE, ATTACK (4', 2-2/3', 2', Length, Mode)

The left-most parameter, RSP (Response) determines how fast the overall organ combination (footages in page 1) volume reaches maximum level, between a range of 0 (fastest) and 7

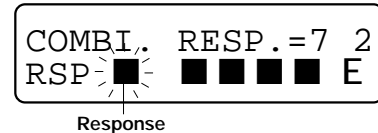

(slowest). There are three Attack footages which determine the character of the percussive portion of the organ voice. You can adjust the volume level of each Attack footage between 0 (no volume) and 7 (maximum volume).

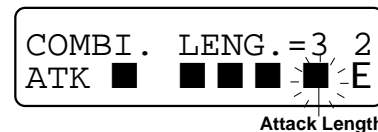
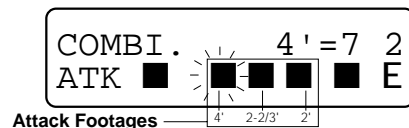

The right-most parameter, Attack mode, determines which notes in a held cluster of notes are given an attack sound. With the (first) setting, only the first note played will have an attack; all other notes played while the first note is held will have no attack. With the [E] (Each) setting, all notes played will have an attack sound.



## ■ Pitch Bend (PB)/Modulation Wheel (MW)

This function lets you set the maximum range that the pitch will bend when you use the [PITCH] wheel, as well as determine the type of effect assigned to the [MODULATION] wheel.

### ● PITCH BEND RANGE (0 ~ 12)

You can set the pitch to bend up or down for each voice within one octave, where 0 represents no pitch bend, and 12 represents one octave. (The default for each voice is set to 2.) Each unit is one semitone.



#### NOTE

Moving the [PITCH] wheel to its extreme position while playing the lowest or highest note on the keyboard may exceed the P-150's legal range (A-1 ~ C7). In such a case, the P-150 will play and repeat the one octave higher or lower range. (This also occurs if the Transpose setting causes the pitch bend to exceed the legal range.)

### ● MODULATION WHEEL ASSIGN (Off, Reverb Depth, Modulation Speed, Vibrato)

You can assign one of three effects for each voice to the [MODULATION] wheel, or turn the effect off.



#### NOTE

The vibrato effect is internally set and cannot be modified. Note that trying to apply the vibrato effect to the Piano 1 ~ 4 voices will have no effect.

## ■ Keyboard Sensitivity

The Keyboard Sensitivity function lets you control how the volume of the internal voices and connected MIDI instruments respond to your playing.

The P-150 lets you designate independent Keyboard Sensitivity settings for the internal tone generator (each voice) and external MIDI devices, as well as the minimum and maximum range of the keyboard volume.

### ● KEYBOARD SENSITIVITY INTERNAL (Normal, Soft-1~3, Hard-1~3, Fixed-1~3)

This setting determines how the P-150's keyboard affects the internal voices. There are ten different types of sensitivity settings. (For details, see Velocity Curves, below.)

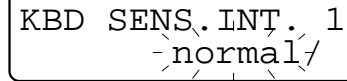

### ● KEYBOARD SENSITIVITY MIDI (Normal, Soft-1~3, Hard-1~3, Fixed-1~3)

This setting determines how the P-150's keyboard affects external MIDI devices, such as a tone generator. There are ten different types of sensitivity settings. (For details, see Velocity Curves, next page.)

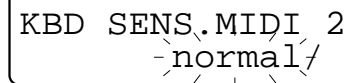

### ● KEYBOARD RANGE (Minimum, Maximum)

The values set here determine the minimum and maximum volume range of the keyboard, between 1 and 128. (You cannot set the minimum number to exceed the maximum number.)



#### NOTE

When both minimum and maximum are set to 1, no sound will be produced.

## Velocity Curves

The P-150 has 10 different types of sensitivity settings for both internal voices and external MIDI instruments, organized in four categories: Normal, Soft-1~3, Hard-1~3, and Fixed-1~3.

These give you wide and flexible control over how the strength of your playing affects the volume of the internal voices and external MIDI instruments.

### ☐ NORMAL

The P-150's Normal setting represents the standard linear "velocity-to-volume" relationship.

On a conventional acoustic instrument such as an acoustic piano, the harder you play, the louder the resulting sound. Generally, this velocity-to-volume relationship is linear, i.e., the sound becomes louder in direct proportion to the strength with which you play, as shown in the following graph.

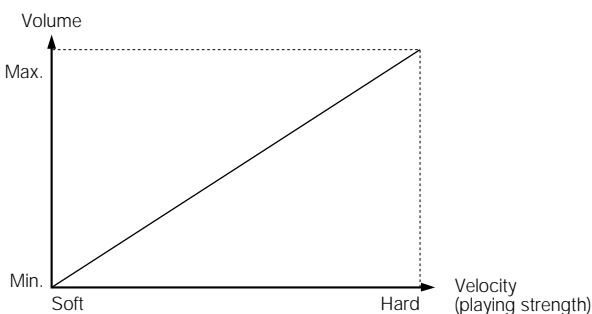

### ☐ Soft-1, Soft-2, Soft-3

The Soft curves are designed to increase the level of the sound with a softer playing style.

KBD SENS. INT 1  
soft -2e

### ☐ Hard-1, Hard-2, Hard-3

The Hard curves are designed to increase the level of the sound with a stronger playing style.

KBD SENS. INT 1  
hard -1h

### ☐ Fixed-1, Fixed-2, Fixed-3

The Fixed curves create flat velocity response. The volume of the sound remains the same, no matter how softly or strongly the keys are played.

KBD SENS. INT 1  
fixed -1i

## ■ Internal Equalizer

The Internal Equalizer function lets you adjust the volume of the low, middle and high EQ ranges for the currently selected internal voice.

EQ LOW = 0 1

### ● EQ (Low, Mid, High)

You can boost (increase) or cut (decrease) the volume of each range independently, with -16 representing maximum volume cut, 16 representing maximum volume boost, and 0 representing normal volume. (The default for each voice is 0.)

## ■ Reverb

When the P-150 is in Edit mode, pressing [REVERB] accesses the Reverb Type and Depth settings for the currently selected voice.

REVERB TYPE 1  
T=room D=4  
Reverb type Depth

### ● REVERB TYPE (Room, Stage, Hall, Off)

You can select one of the three reverb types for the currently selected voice or turn the reverb off.

### ● DEPTH (0 ~ 7)

You can set the reverb depth value between 0 (no effect) and 7 (maximum effect).

### NOTE

You can also access the Reverb Type and Depth parameters in Voice Play mode (see page 22).

## ■ Modulation

When the P-150 is in Edit mode, pressing [MODULATION] accesses the Modulation Type and Speed settings for the currently selected voice.

MOD. TYPE 1  
T=tremolo S=2  
Modulation type Speed

### ● MODULATION TYPE (Chorus, Symphonic, Tremolo, Off)

You can select one of the three modulation types for the currently selected voice or turn the modulation off.

### ● SPEED (0 ~ 7)

You can set the modulation speed value between 0 (no effect) and 7 (maximum effect).

### NOTE

You can also access the Modulation Type and Speed parameters in Voice Play mode (see page 23).



# STORE

When Auto Store is designated all parameter changes are stored automatically as you make them. Thus, you can jump back and forth between voices and Voice and Performance modes freely as you play, since all settings will remain as you set them. In this case, necessary storing is literally a matter of copying one Performance to a specific Performance bank and number.

When Non Auto Store is designated, in general the changes you make to voices such as reverb and modulation settings will be lost as soon as you change voices, Performances or modes. After making changes in Edit mode, however, the P-150 will prompt you and give you the opportunity to overwrite the current edit when you try to leave Edit mode.

You will find it most convenient to set up your Performances in Voice Play mode, Auto Store status, since voice selection is so simple, then copy it to one of the 24 Performance memories for instant recall when you need it.

By switching into Non Auto Store status, you can be sure that your Performances are protected, and any changes you make in one will not be applied unless you specifically store it.

For details about changing the Store status, see page 11.

Note that there is a fine distinction between Voice Play mode store and Performance Play mode store functions. In Voice Play mode, you can overwrite the current set of Voice and Performance parameter settings. In Performance Play mode, you can select a specific destination Performance in which to make a duplicate, or copy the current Performance parameter settings. Therefore, if you select a destination Performance in which to store the current Voice Play mode Performance parameter settings, you are storing it in the Performance Play mode.

## NOTE

Regardless of the Auto Store/Non Auto Store status, the parameter changes made in the System, MIDI Filter and PC Table functions are always stored automatically.

## OVERWRITING IN PLAY MODE

1. In Voice Play mode, press the [STORE] button. The LED above the [STORE] button starts blinking. The following screen appears.



STORE? (YES/NO)  
Voices -> Voices

2. Press [+1/YES] if you want to overwrite the current Voice and Performance parameter settings. (Press [-1/NO] if you want to cancel the store operation and return to the previous mode.) The STORE COMPLETED screen briefly appears to confirm the store operation.



\*\* STORE \*\*  
\*\* COMPLETED \*\*

## STORING A PERFORMANCE

1. In either Voice Play mode or Performance Play mode, press the [STORE] button. The LED above the [STORE] button starts blinking. The following screen appears.

STORE? (YES/NO)  
A01 -> A01

2. To overwrite the current Performance:  
Press [+1/YES]. (Press [-1/NO] if you want to cancel the store operation and return to the previous mode.) This effectively stores the changes you have made in Edit mode (except for changes made in the overall System settings in the System, MIDI Filter and PC Table functions, which are stored automatically) in the current Performance location, and thus will be retained the next time you enter Performance Play mode.
  
3. To copy the current Performance into another Performance location: First press [PERF. A] or [PERF. B] to designate the destination Performance bank, then press the desired [PERFORMANCE SELECT] button to designate the Performance number. (You can also designate the destination Performance bank and number by moving the [DATA ENTRY] slider.)

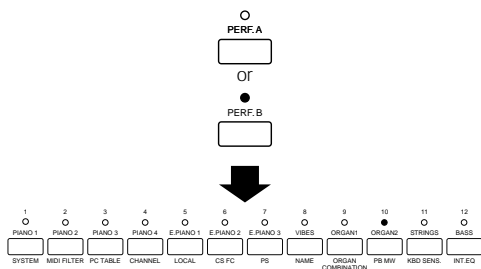

STORE? (YES/NO)  
A01 -> B10

The name of the Performance bank and number appears in the screen.

4. Press [+1/YES] to store the current Performance into the designated Performance bank and number. (Press [-1/NO] if you want to cancel the store operation and return to the previous mode.) The STORE COMPLETED screen briefly appears to confirm the store operation.

STORE

# APPENDIX

## ■ Bulk Dump

The Bulk Dump feature lets you offload parameter settings by sending it to an external MIDI data storage device (such as the Yamaha MDF2 MIDI Data Filer), as well as load it back into the P-150 by receiving it from an external storage device.

This gives you the luxury of being able to build a library of P-150 settings by storing them on floppy disks.

The P-150 can send and receive four types of data in bulk:

All data (the P-150's entire settings); Voice data (Voice settings only); Performance Bank A data (Performance settings for the A bank only); and Performance Bank B data (Performance settings for the B bank only).

## Send Bulk Data

A send bulk data operation must be initiated from the P-150. First, however, make sure the P-150's MIDI Merge function is off (see page 44).

Next, match the device number of the P-150 (see page 44) with the external storage device by assigning the same device number to each. Then, set the external device so that it is standing by waiting for a bulk dump receive message. (For details about how to set the device number and bulk receive standby for the external device, consult the external device's owner's manual.)

## SENDING BULK DATA

1. Voice Data: Hold the [MIDI] button and press the [VOICE] button.

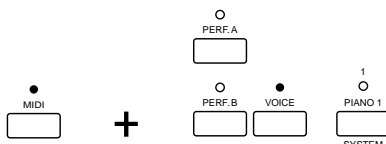

2. Performance Bank A Data: Hold the [MIDI] button and press the [PERF. A] button.

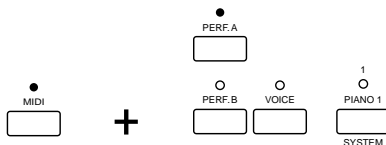

3. Performance Bank B Data: Hold the [MIDI] button and press the [PERF. B] button.

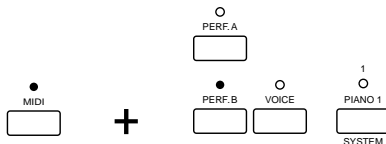

4. All Data: Hold the [MIDI] button and press the [PIANO 1 SELECT] button.

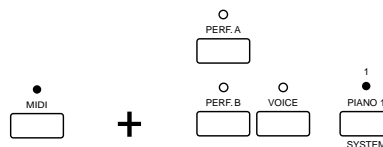

The BULK SEND screen appears while the operation is in progress.



When the operation is finished, the BULK SEND COMPLETED screen briefly appears.



To cancel the operation while it is still in progress, press the [-1/NO] button. The BULK SEND EXIT screen briefly appears.



### NOTE

The send bulk data operation cannot be executed when the MIDI Transmit Filter (bulk) is set to On, or the device number is set to Off.

## Bulk Data Receive

Bulk data receive operations must be initiated from the external device. First, however, make sure the P-150's MIDI Receive Filter (bulk) function is off (see page 46). Next, make sure the device numbers of both devices are set to the same number (see page 44).

Once you have made these preliminary preparations, exit the Edit mode and return to the Voice Play or Performance Play mode. Now you're ready to send data to the P-150 using the external device's send bulk data operation. The P-150 will automatically accept the data. (For details about setting the device number of the external device and initiating a send bulk data operation, see the external device's owner's manual.)

# ■ Initialize

The Initialize feature lets you restore the initial factory default settings with a quick and simple operation. Before initializing the settings, make sure to first offload any data that you want to save using the Bulk Dump operation. Otherwise, the Voice and Performance data you have created will be lost permanently.

## INITIALIZING THE DEFAULT SETTINGS

1. Press the [POWER] switch to turn off the power.
2. To initialize all the default settings, hold both the [MIDI] and [EDIT] buttons, then press the [POWER] switch to turn on the power.

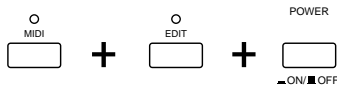

The INITIALIZE ALL screen briefly appears.



PERFORMANCE A (or B) BANK: You can also initialize only the Performance A bank (or B bank) default settings. To do so, first turn the power off, then hold both the [MIDI] and [PERF. A] (or [PERF. B]) buttons and turn the power back on.

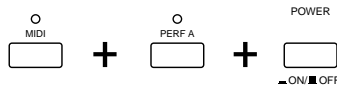

VOICE SETTINGS: Similarly, you can initialize only the Voice parameter default settings. To do so, first turn the power off, then hold both the [MIDI] and [VOICE] buttons and turn the power back on.

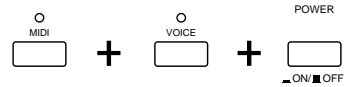

## Factory Default Settings

The default settings are shown in Factory Default Settings lists on pages 64, 65 and 66.

## ■ Using MIDI

MIDI is an acronym that stands for Musical Instrument Digital Interface, an international standard in use since the 1980s for the purpose of allowing electronic musical instruments—such as synthesizers, tone generators, rhythm programmers, digital keyboards like the P150, and others—to “communicate” with each other by sending and receiving compatible note, controller and other MIDI data.

With MIDI, instruments made by different manufacturers can easily be connected to each other using special MIDI cables, and configured to work together in a variety of ways that greatly expands your music composing, performing and even learning capabilities.

Following is an outline of the basic concepts about MIDI you'll need to know to get up and running in short order. Also included are a few examples of MIDI system connections.

### MIDI Channels

The MIDI standard provides 16 different channels for the transmission of data between musical instruments. A MIDI KEYBOARD is capable of transmitting data on at least one of these channels. Sequencers and MIDI-equipped computers with music sequencing software (both of which are generally capable of recording, editing and playing back MIDI note, controller and other data) usually transmit data on several channels at once, each channel being designated for a different part of an ensemble performance. For example, a Piano part might be assigned to channel 1, a bass part to channel 2, a horn part to channel 3, and so on.

MIDI devices known as TONE GENERATORS, which are literally synthesizers without a keyboard, can receive MIDI data from keyboards, sequencers, or computers and produce sounds in response. MULTITIMBRAL tone generators can play more than one voice at a time, since they can receive data on more than one channel at a time.

### MIDI Messages

Data which is transmitted between MIDI devices takes the form of MIDI messages. There are various types of messages. Messages most closely associated with the actual performance of music are called CHANNEL VOICE messages; these include NOTE ON and NOTE OFF messages, which tell a tone generator which notes to play, and when to start and stop playing them. CONTROL CHANGE, PITCH BEND, and AFTERTOUCH or key pressure messages indicate how a keyboard's control functions are being operated. PROGRAM CHANGE messages tell a tone generator to switch to another voice.

Channel voice messages are transmitted on a specific channel which will be received by the tone generator for which they are intended. They are different from SYSTEM messages, which are transmitted on all channels and received by all of the devices in a MIDI system.

System messages also come in a number of varieties. SYSTEM REALTIME messages are used to start, stop and synchronize the sequencing devices in a MIDI system. SYSTEM EXCLUSIVE messages allows for the transmission of data specific to individual devices. This data can be either individual parameter settings, which are transmitted as PARAMETER CHANGE messages, or large blocks of settings, which are usually referred to as BULK DUMPS. When using the P-150's MIDI functions, you will be mainly concerned with channel voice messages and system exclusive messages. For detailed information about other types of messages the P-150 supports, and how their corresponding functions are implemented, refer to the MIDI Data Format and MIDI Implementation Chart sections.

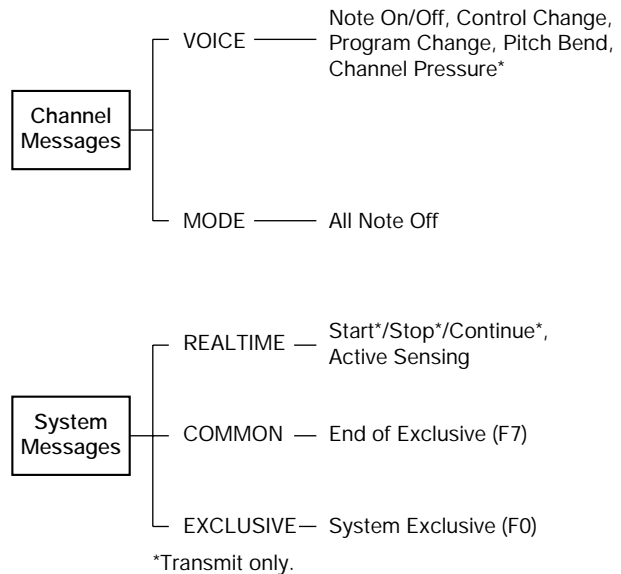

## MIDI Terminals

MIDI devices transmit messages to each other via special MIDI cables, which are connected to special MIDI terminals on each device. There are three types of MIDI terminals: IN, OUT, and THRU.

Not all MIDI devices have three MIDI terminals, but most, including the P-150, do. A device with all three terminals will receive incoming data via its MIDI IN terminal, and output its own data via the MIDI OUT terminal. The MIDI THRU terminal merely echoes, or passes, the data received at the MIDI IN terminal unaffected. This allows a device to be connected in the middle of a series (or "daisy chain") of instruments, so that the third instrument in the chain will receive the data transmitted by the first instrument rather than that transmitted by the second.

Some MIDI instruments, such as the P-150, have a MIDI merge feature which essentially combines the functions of the MIDI OUT and MIDI THRU terminals. For example, when the P-150's MIDI merge function is turned on, the MIDI OUT terminal will output a combination of the P-150's own data plus the messages it receives via its MIDI IN terminal. An instrument receiving this merged data will be controlled by both the P-150 and the device connected to the P-150's MIDI IN terminal.

## MIDI System Connections

One of the simplest MIDI setups is to connect the P-150 to one or more tone generators (such as the Yamaha MU80), as shown in the following example.

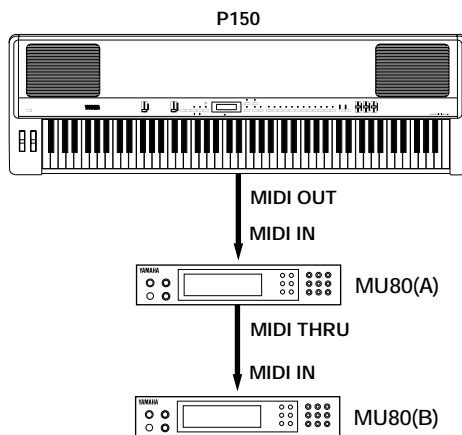

In this case, you can select the voices of both external tone generators directly from the P-150's panel. In Single or Dual mode, the notes you play on the P-150's keyboard will play designated voices in the external tone generators, so long as their MIDI receive channels are assigned to the same number as the P-150's MIDI transmit channel number. In Split mode, the P-150 can transmit on two MIDI channels at the same time (one for the main and one for the sub voice), so you can set one tone generator to respond to only the main voice notes and the other tone generator to respond only to the sub voice notes. You can also take advantage of the P-150's ability to have independent transpose and keyboard sensitivity settings for its internal tone generator and MIDI transmit note messages.

## P-150 MIDI Controllers

The P-150's MIDI controllers include the two [PS] buttons, the [CS] slider, [PITCH] and [MODULATION] wheels and [FC] Footswitch. You can set the controllers to transmit specific control messages, and assign the external tone generators to respond accordingly. The [PITCH] wheel is dedicated to pitch bend and cannot be assigned otherwise.

## Connecting a Sequencer

Another simple MIDI setup is to connect the P-150 to a sequencer, as shown in the following example.

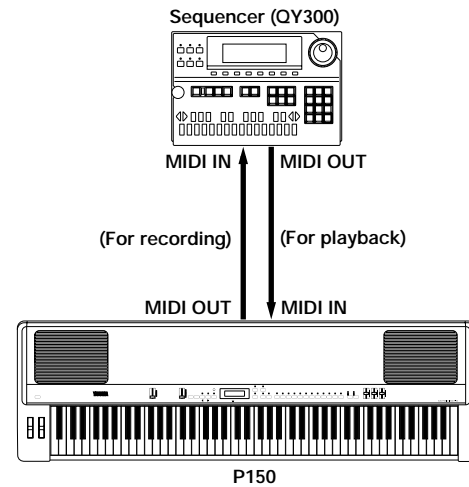

In this case, the sequencer is used to record the note, program change, controller, etc. data as you play the P-150, and then play it back using the P-150's internal voices. You can start and stop the sequencer using the P-150's [PS] buttons (see page 50). Some sequencers have extensive note and other data editing features. The setup shown above will also work for bulk data storage operations (see page 55). Use a sequencer or a special MIDI data storage device (such as the Yamaha MDF2 MIDI Data Filer) to save data from and restore data to the P-150.

A more sophisticated MIDI setup is required if you want to connect a sequencer, several tone generators and perhaps an effects device. The series, or “daisy chaining” method is shown in the following illustration.

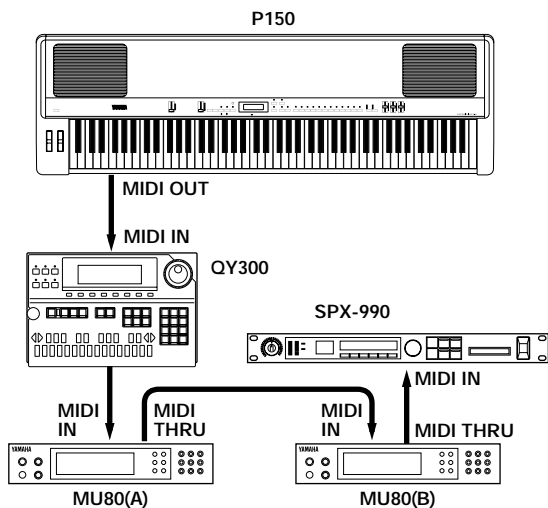

In this case, the sequencer is used to record the note, program change, controller, etc. data as you play the P-150, and then play it back using the voices in the external tone generators, as well as the P-150's internal voices. Multitimbral tone generators (such as the Yamaha MU80) can play more than one voice at a time, so you can configure them for layering several voices by assigning the same MIDI channel to more than one voice, or build up a complex ensemble by assigning a different MIDI channel to each voice that makes up a part in your composition.

You can send program change messages directly to the external tone generators and the effects device (such as the SPX-990) from the P-150, or record these messages in the sequencer at specific locations in the song, so that voices and effects will change “on cue” during sequencer playback—thus giving you enormous music production power. Note that since you would be recording each music part using a different voice, you would need to set the P-150's keyboard Local feature to Off status (see page 48).

Be aware that the longer your daisy chain becomes (and also depending on how long your MIDI cables are), the higher the chances that a noticeable “MIDI delay” will occur during play, caused by the time it takes for the MIDI data to reach each device. To avoid such a potentially annoying problem, you can use a MIDI patch bay (such as the Yamaha MJC 8), which is equipped with multiple MIDI IN and MIDI THRU terminals, as shown in the following illustration.

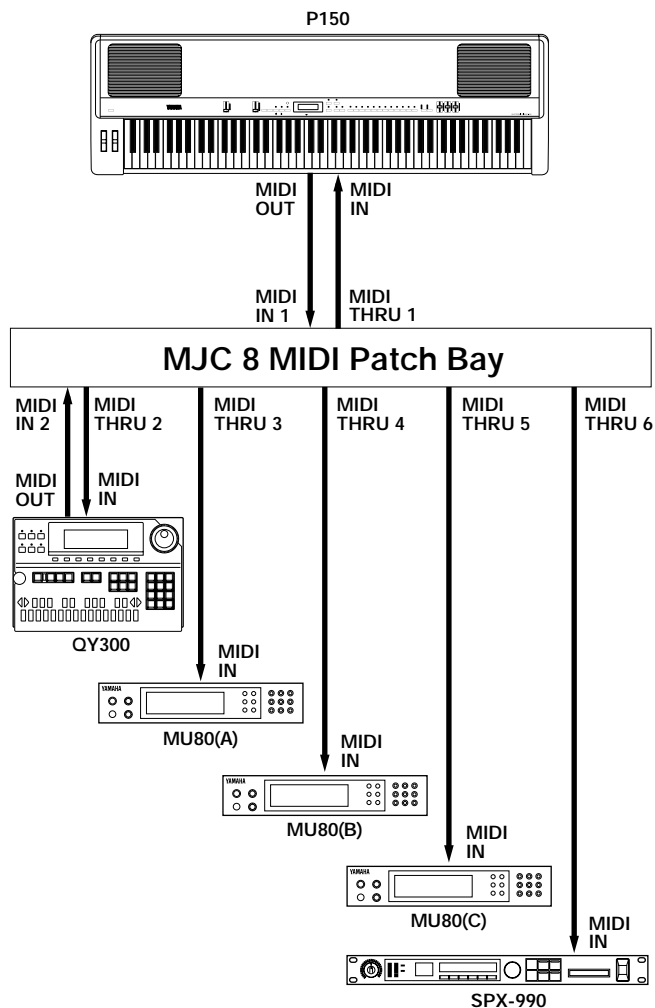

Besides eliminating the possibility of MIDI delays, a MIDI patch bay is essential in a larger setup where you frequently need to perform bulk dump and other operations with specific devices, and don't want to waste time plugging and unplugging cables accordingly. A MIDI patch bay lets you instantly reconfigure the way all MIDI cables are connected for a given application.

## ■ Error Messages

Occasionally you may encounter certain error messages which appear in the LCD screen. Below is a list with descriptions of each.

<pre>*** ERROR1 *** REPLACE BATTERY</pre>	The internal backup battery charge is low and the battery should be replaced. (See page 2.)
<pre>*** ERROR2 *** MIDI RX OVERFLOW</pre>	Too much MIDI data is being received at once. Reception of data is interrupted and cannot be continued. Reduce the amount of data and attempt the operation again.
<pre>*** ERROR3 *** MIDI DATA ERROR</pre>	An error occurred during reception of MIDI data. Check all MIDI connections, settings, etc., and attempt the operation again.
<pre>*** ERROR4 *** MIDI BULK ERROR</pre>	An error occurred during reception of bulk data. Check all MIDI connections, settings, etc., and attempt the operation again.
<pre>*** ERROR5 *** MIDI FILTER ON !</pre>	Certain data cannot be transmitted or received because a MIDI Filter is set to On. Check each MIDI Filter setting in Edit mode. (See page 46.)
<pre>*** ERROR6 *** DEVICE NO. ERROR</pre>	Bulk data cannot be transmitted or received because the Device Number parameter is either turned off or does not match that of the connected device. (See page 55.)
<pre>*** ERROR7 *** MERGE SW ON !</pre>	The Send Bulk Data operation cannot be executed when MIDI Merge is on. (See page 44.)



## ■ Troubleshooting

The P-150 is a rather sophisticated electronic instrument with many parameter settings which affect its operation status. As such, occasionally you may find that it does not function as you think it should.

If this happens, before rushing the P-150 to the service center, carefully and methodically try to isolate the problem. Most of the time you'll find the problem to be of an extremely simple nature.

- The first thing you should do is check whether the problem is in the P-150 itself, or in one of the connected devices, or in any of the audio or MIDI cables.
- Also try changing the voices or Performances on the P-150 and check if the problem persists. If the problem occurs with only one specific voice or Performance, check each of its parameters to see if you can isolate the specific cause. If the problem occurs regardless of which voice or Performance is selected, check the System parameters to see if a particular global setting is the cause.

### Possible Cause and Solution

No sound is output from the P-150	<p>Check that:</p> <ul style="list-style-type: none"> <li>• The [SPEAKER] switch on the rear panel is turned on.</li> <li>• The [VOLUME] slider is turned up.</li> <li>• The Foot Controller that is assigned to Volume or Expression (011) is pressed down.</li> <li>• The Local On/Off feature is set to On. (See page 48.)</li> <li>• (If the Local On/Off feature is set to Off and you're using the P-150 with a sequencer), the Transmit Channel is set to the same number as the Receive Channel. (See page 48.)</li> </ul>
Little or no sound is output	Check that the Keyboard Sensitivity setting is appropriate. (See page 51.)
Depending on which keys of the keyboard are played, no sound (or only a very soft sound) is output	Check that in Split mode, the Balance setting is appropriate. (See page 30.)
The pitch of the P-150 is off or out of tune (compared to standard pitch or other instruments)	<p>Check that:</p> <ul style="list-style-type: none"> <li>• The Master Tune parameter is set correctly. (See page 44.)</li> <li>• The Transpose feature is turned off. (See page 33.)</li> <li>• The Detune (Dual mode) is set to 0. (See page 27.)</li> </ul>
The pitch of the P-150	Check that the modulation settings are turned off, and the [MODULATION] wheel position is not pure set to minimum.
The sound is too thin, or too "boomy", or radically different in timbre than expected	Check the Internal EQ as well as the Panel Equalizer settings. Adjust one or the other to flat, or normal settings. (See pages 24, 52.) Also check the [MODULATION] wheel position, or the effect settings, as these can drastically alter the sound. (See pages 22, 23, 51.)
Some notes of a chord or sustained passage (See (held with the Footswitch) time cannot be heard	You may have played more notes than the maximum polyphony of the P-150. Remember that polyphony is decreased when Dual or Split mode is active, or a stereo Piano is selected. (See page 21.) The situation may also occur when playing the P-150's keyboard at the same time a sequencer is playing internal voices.
The reverb or modulation effect cannot be heard	<p>Check that:</p> <ul style="list-style-type: none"> <li>• The Reverb is set to Active and not Bypass. (See page 44.)</li> <li>• The Reverb Depth setting or Modulation Speed setting is not 0. (See page 52.)</li> </ul>
No sound is output from the connected MIDI instruments	<p>Check that:</p> <ul style="list-style-type: none"> <li>• All MIDI connections have been properly made. (See pages 58, 59.)</li> <li>• The receive channel of the connected device matches that of the Transmit Channel for the P-150. (See page 47.)</li> <li>• The MIDI Transmit switch is enabled. (See page 36.)</li> <li>• The Volume level settings of connected devices are at appropriate levels.</li> </ul>

Cannot transmit MIDI messages even though the MIDI Transmit switch is on	Check that message types are turned off in the MIDI Filter menu of Edit mode, and that the Transmit channel is not set to off in Edit mode. (See page 47.)
The sound of the connected MIDI instruments is too soft (or too loud)	Check that the Keyboard Sensitivity settings are appropriate. (See page 51.)
Connected MIDI instruments sound, but do not change programs when changing voices or Performances on the P-150	Check that the program change receive (or the equivalent parameter) on the receiving MIDI instrument has not been turned off.
Sustain (Footswitch pedal operation) doesn't work properly	Check that the Footswitch is properly connected to the [SUSTAIN] jack.
Cannot select the Organ 1 voice	The Organ 1 voice is not accessible in Dual mode.
Transpose value or split point cannot be changed by using the [DATA ENTRY] slider, or balance and detune values cannot be changed by the [-1/NO] or [+1/YES] buttons	You cannot use the [DATA ENTRY] slider to change the transpose value or split point; you must hold the [TRANSCOPE] or [SPLIT] button and use the [-1/NO] or [+1/YES] buttons. Likewise, you cannot use the [-1/NO] or [+1/YES] buttons to change the balance or detune values; you must hold the [BALANCE] or [DETUNE] button and move the [DATA ENTRY] slider.

# ■ Specifications

Keyboard	88-key (A-1 to C7), velocity sensitive, Action Effect II				
Tone Generator	AWM; 32-note maximum polyphony				
Voices	PIANO 1 ~ 2 (STEREO/MONO); PIANO 3 ~ 4; ELECTRIC PIANO 1 ~ 3; VIBES; ORGAN 1 ~ 2; STRINGS; BASS (ELECTRIC/UPRIGHT)				
Play Modes	Voice Play mode; Performance Play mode				
Performances	Performance Bank A (1 ~ 12); Performance Bank B (1 ~ 12)				
Effects	REVERB (ROOM, STAGE, HALL, OFF); MODULATION (CHORUS, SYMPHONIC, TREMOLO, OFF)				
Panel Equalizer	LOW; MIDDLE; HIGH				
Edit	SYSTEM	MASTER TUNE	424.0Hz ~ 456.3Hz		
		REVERB	bypass, active		
		DEVICE NUMBER	off; 1 ~ 16; all		
		MIDI MERGE	off; on		
		PERFORMANCE ENABLE	MIDI CHANNEL (sys; perf); LOCAL (sys; perf); CONTROLLER ASSIGN (sys; perf)		
		POPOP TIME	PC (off; 1 ~ 5); OTHERS (1 ~ 5)		
		STORE TYPE	auto store; non auto store		
	MIDI FILTER	TRANSMIT FILTER	Message Types; on/off		
		RECEIVE FILTER	Message Types; on/off		
	PC TABLE	PROGRAM CHANGE TRANSMIT	VOICE/PERFORMANCE NO.(1 ~ 12); MSB/LSB (off; 0 ~ 127); PROGRAM CHANGE NUMBER (off; 0 ~ 128)		
		PROGRAM CHANGE RECEIVE	VOICE/PERFORMANCE NO. (off; 1 ~ 12); PROGRAM CHANGE NUMBER (1 ~ 128)		
		CHANNEL	TRANSMIT (off; 1 ~ 16); RECEIVE (off; 1 ~ 16; all)		
	LOCAL	on; off			
	CS FC	CS ASSIGN (functions)	CS RANGE MIN (1 ~ 128); MAX (1 ~ 128)		
		FC ASSIGN (functions)	FC RANGE MIN (1 ~ 128); MAX (1 ~ 128)		
	PS	PS1 ASSIGN (off; start:FA; continue:FB; stop:FC)			
		PS2 ASSIGN (off; start:FA; continue:FB; stop:FC)			
	NAME	PERFORMANCE NAME			
	ORGAN COMBINATION	FOOTAGE	16', 8', 5-1/3', 4', 2-2/3', 2', 1-1/3', 1'; (0 ~ 7)		
			RESPONSE (0 ~ 7)		
			ATTACK	4', 2-2/3', 2'; (0 ~ 7)	
				LENGTH (0 ~ 7)	
				Mode (First, Each)	
	PB MW	PITCH BEND RANGE (0 ~ 12)	MODULATION WHEEL ASSIGN (off; reverb depth; mod. speed; vibrato)		
	KBD SENS.	KEYBOARD SENSITIVITY INTERNAL	normal; soft-1~3; hard-1~3; fixed-1~3		
		KEYBOARD SENSITIVITY MIDI	normal; soft-1~3; hard-1~3; fixed-1~3		
		KEYBOARD RANGE	MIN (1 ~ 128); MAX (1 ~ 128)		
INT. EQ	LOW (-16 ~ 16); MID (-16 ~ 16); HIGH (-16 ~ 16)				
REVERB	TYPE (ROOM, STAGE, HALL, OFF); DEPTH (0 ~ 7)				
MODULATION	TYPE (CHORUS, SYMPHONIC, TREMOLO, OFF); SPEED (0 ~ 7)				
Controls	POWER; VOLUME; CS (DATA ENTRY); PS1 (-1/NO); PS2 (+1/YES); SPLIT (BALANCE, 1); TRANSPOSE (DETUNE, q); MIDI (PAGE); LCD CONTRAST; PITCH WHEEL; MODULATION WHEEL; STORE; EDIT; PERF. A; PERF. B; VOICE; SELECT 1 ~ 12; REVERB, MODULATION; EQUALIZER; SPEAKER ON/OFF				
LCD screen	16-character x 2-row, backlit				
Button Lamps	SPLIT, TRANSPOSE, MIDI enable, STORE, EDIT, PERF. A, PERF. B, VOICE, 1 ~ 12 buttons, EFFECT x 6				
Input Jacks	FOOT CONTROLLER, SUSTAIN, SOSTENUTO, SOFT; LINE IN (L/MONO, R; 1/4" phone)				
Output Jacks	LINE OUT (L/MONO, R; unbalanced, 1/4" phone); PHONES				
MIDI Terminals	MIDI IN / OUT / THRU				
Electrical Characteristics	Power Consumption: 70 W; Output Impedance: 600Ω; Input Impedance: 10 kΩ				
Amplifiers	30 W x 2				
Speakers	13 cm (5-1/8") x 2				
Dimensions	1385(W) x 424(D) x 159(H) mm (54-1/2" x 16-3/4" x 6-1/4")				
Weight	33.7kg (74 lbs.)				
Included Accessory	FC4 Footswitch				
Optional Accessories	Yamaha FC4, FC5 Footswitches; Yamaha FC7 Foot Controller; Yamaha Keyboard Stand LP-3				

Specifications and descriptions in this Owner's Manual are for information purpose only. Yamaha Corp. reserves the right to change or modify products or specifications at any time without prior notice. Since specifications, equipment or options may not be the same in every locale, please check with you Yamaha dealer.

# ■ FACTORY DEFAULT SETTINGS

## SYSTEM

<b>MIDI TRANSMIT ENABLE SW</b>		on			
<b>SYSTEM</b>	MASTER TUNE	440.0			
	REVERB	active			
	DEVICE NUMBER	1			
	MIDI MERGE	off			
	PERFORMANCE ENABLE	MIDI CHANNEL	sys		
		LOCAL ON/OFF	sys		
		ASSIGN	sys		
	POPUP TIME	PC SEND	off		
		OTHERS	3		
STORE TYPE	non auto store				
<b>MIDI FILTER</b>	TRANSMIT	Note On/Off	off		
		Control Change	off		
		Program Change	off		
		Aftertouch	off		
		Pitch Bend Change	off		
		Channel Mode Message	off		
		Parameter Change	on		
		Bulk	off		
		FA/FB/FC	off		
	RECEIVE	Note On/Off	off		
		Control Change	off		
		Program Change	off		
		Pitch Bend Change	off		
		Channel Mode Message	off		
		Parameter Change	on		
		Bulk	off		
		<b>PROGRAM CHANGE TABLE</b>	TX	NUMBER	Voice 01,...,Perf. A01,...,Perf. B12 = 1,...,13,...,36
				BANK LSB	Voice 01,...,Perf. A01,...,Perf. B12 = off
BANK MSB	Voice 01,...,Perf. A01,...,Perf. B12 = off				
RX	NUMBER		1,...,36 = Voice 01,...,Perf. B12		

# PRESET VOICE LIST

			SINGLE	DUAL	SPLIT
<b>PLAY MODE</b>			SINGLE		
<b>VOICE</b>	MAIN	Piano1			
	SUB	_____	Strings	Bass	
<b>PIANO 1 STEREO/MONO</b>			stereo		
<b>PIANO 2 STEREO/MONO</b>			stereo		
<b>BASS ELECTRIC/UPRIGHT</b>			electric		
<b>ORGAN COMBINATION</b>	HOLD	16'	6		
		8'	5		
		5-1/3'	5		
		4'	0		
		2-2/3'	0		
		2'	0		
		1-1/3'	0		
		1'	0		
	RESPONSE	0			
	ATTACK	4'	0		
		2-2/3'	5		
		2'	0		
		LENGTH	3		
		EACH/FIRST	Each		
<b>BALANCE</b>			_____	0	0
<b>DETUNE</b>			_____	0	_____
<b>SPLIT POINT</b>			_____	_____	C2
<b>SPLIT MAIN VOICE AREA</b>			_____	_____	Higher Note Range
<b>TRANPOSE</b>	ENABLE SWITCH		off		
	INTERNAL	MAIN	+12		
		SUB	_____	0	0
	MIDI	MAIN	+12		
SUB		_____	_____	0	
<b>MIDI CHANNEL</b>	TX CHANNEL		1		
	RX CHANNEL		1		
<b>LOCAL</b>			on		
<b>CONTROLLERS</b>	PS1	ASSIGN	off		
	PS2	ASSIGN	off		
	CS	ASSIGN	main volume : 007		
		RANGE MIN	1		
		RANGE MAX	128		
	FC	ASSIGN	sub volume (internal)		
		RANGE MIN	1		
		RANGE MAX	128		

			Piano 1	Piano 2	Piano 3	Piano 4	E.Piano1	E.Piano2	E.Piano3	VIBES	ORGAN 1	ORGAN 2	STRINGS	BASS
<b>CONTROLLERS</b>	PITCH BEND	RANGE	2	2	2	2	2	2	2	2	2	2	2	2
	MODULATION WHEEL	ASSIGN	mod.speed	mod.speed	mod.speed	mod.speed	mod.speed	mod.speed	mod.speed	vibrato	mod.speed	mod.speed	mod.speed	off
<b>KBD SENS.</b>	INTERNAL	TYPE	normal	normal	soft-2	soft-1	hard-2	soft-3	hard-1	hard-2	fixed-1	fixed-1	hard-3	normal
		MIDI	normal	normal	soft-2	soft-1	hard-2	soft-3	hard-1	hard-2	fixed-1	fixed-1	hard-3	normal
		RANGE MIN	1	1	1	1	1	1	1	1	1	1	1	1
		RANGE MAX	128	128	128	128	128	128	128	128	128	128	128	128
<b>EFFECT</b>	REVERB	TYPE	hall	stage	stage	stage	room	stage	hall	hall	hall	room	hall	room
		DEPTH	1	3	3	2	2	1	3	2	2	4	5	3
	MODULATION	TYPE	off	off	off	off	chorus	chorus	symphonic	tremolo	tremolo	tremolo	off	chorus
		SPEED	2	1	2	3	2	3	3	3	0	0	1	2
	INTERNAL EQUALIZER	LOW	0	-3	+5	+2	-9	-7	+7	-7	0	+4	+3	-2
		MID	0	0	-3	-5	0	0	-11	+6	0	0	0	0
HIGH		+3	0	+10	+3	+5	-3	+6	0	0	+2	+7	0	

# PRESET PERFORMANCE LIST

			PERF. A 01			PERF. A 02			PERF. A 03			PERF. A 04			PERF. A 05		
			SINGLE	DUAL	SPLIT	SINGLE	DUAL	SPLIT	SINGLE	DUAL	SPLIT	SINGLE	DUAL	SPLIT	SINGLE	DUAL	SPLIT
<b>PLAY MODE</b>			SINGLE			DUAL			SINGLE			SINGLE			DUAL		
<b>VOICE</b>	MAIN		Piano1			Piano3			Piano3			Piano4			Piano1		
	SUB		—	Strings	Bass	—	Piano2	Bass	—	Strings	Bass	—	Strings	Bass	—	E.P.1	Bass
<b>PIANO 1 STEREO/MONO</b>			stereo			stereo			stereo			stereo			stereo		
<b>PIANO 2 STEREO/MONO</b>			stereo			stereo			stereo			stereo			stereo		
<b>BASS ELECTRIC/UPRIGHT</b>			electric			electric			electric			electric			electric		
<b>ORGAN COMBINATION</b>	HOLD	16'	6			6			6			6			6		
		8'	5			5			5			5			5		
		5-1/3'	5			5			5			5			5		
		4'	0			0			0			0			0		
		2-2/3'	0			0			0			0			0		
		2'	0			0			0			0			0		
		1-1/3'	0			0			0			0			0		
		1'	0			0			0			0			0		
	RESPONSE	0			0			0			0			0			
	ATTACK	4'	0			0			0			0			0		
		2-2/3'	5			5			5			5			5		
		2'	0			0			0			0			0		
		LENGTH	3			3			3			3			3		
		EACH/FIRST	Each			Each			Each			Each			Each		
<b>BALANCE</b>			—	0	0	—	0	0	—	0	0	—	0	0	—	-2	0
<b>DETUNE</b>			—	0	—	—	6	—	—	0	—	—	0	—	—	3	—
<b>SPLIT POINT</b>			—	—	C2	—	—	C2	—	—	C2	—	—	C2	—	—	C2
<b>SPLIT MAIN VOICE AREA</b>			—	—	Higher Note Range	—	—	Higher Note Range	—	—	Higher Note Range	—	—	Higher Note Range	—	—	Higher Note Range
<b>TRANPOSE</b>	ENABLE SWITCH		off			off			off			off			off		
	INTERNAL	MAIN	+12			+12			+12			+12			+12		
		SUB	—	0	0	—	0	0	—	0	0	—	0	0	—	0	0
	MIDI	MAIN	+12			+12			+12			+12			+12		
SUB		—	—	0	—	—	0	—	—	0	—	—	0	—	—	0	
<b>MIDI CHANNEL</b>	TX CHANNEL		1			1			1			1			1		
	RX CHANNEL		1			1			1			1			1		
<b>LOCAL</b>			on			on			on			on			on		
<b>CONTROLLERS</b>	PS1	ASSIGN	off			off			off			off			off		
	PS2	ASSIGN	off			off			off			off			off		
	CS	ASSIGN	main volume : 007			main volume : 007			main volume : 007			main volume : 007			main volume : 007		
		RANGE MIN	1			1			1			1			1		
		RANGE MAX	128			128			128			128			128		
	FC	ASSIGN	sub volume (internal)			sub volume (internal)			sub volume (internal)			sub volume (internal)			sub volume (internal)		
		RANGE MIN	1			1			1			1			1		
RANGE MAX		128			128			128			128			128			
<b>PERFORMANCE NAME</b>			Room Acoustic			Honky Tonk			Pan Piano			Chorus Piano			Ballad Piano		

<b>CONTROLLERS</b>	PITCH BEND	RANGE	2			2			2			2			2		
	MODULATION WHEEL	ASSIGN	mod.speed			mod.speed			mod.speed			reverb depth			mod.speed		
<b>KEYBOARD SENSITIVITY</b>	INTERNAL	TYPE	normal			hard-2			normal			hard-2			hard-2		
		MIDI	normal			hard-2			normal			hard-2			hard-2		
		RANGE MIN	1			1			1			1			1		
		RANGE MAX	128			128			128			128			128		
<b>EFFECT</b>	REVERB	TYPE	room			room			stage			hall			stage		
		DEPTH	6			2			4			7			3		
	MODULATION	TYPE	off			off			tremolo			chorus			off		
		SPEED	3			0			0			7			2		
	INTERNAL EQUALIZER	LOW	0			-12			-13			-1			0		
		MID	0			+16			+7			-16			0		
HIGH		0			-12			-12			+5			+7			

PERF. A 06			PERF. A 07			PERF. A 08			PERF. A 09			PERF. A 10			PERF. A 11			PERF. A 12		
SINGLE	DUAL	SPLIT	SINGLE	DUAL	SPLIT	SINGLE	DUAL	SPLIT	SINGLE	DUAL	SPLIT	SINGLE	DUAL	SPLIT	SINGLE	DUAL	SPLIT	SINGLE	DUAL	SPLIT
DUAL			DUAL			DUAL			DUAL			DUAL			DUAL			SINGLE		
E.Piano1			E.Piano1			E.Piano1			E.Piano3			E.Piano3			Bass			E.Piano2		
—	Piano4	Bass	—	E.P.2	Bass	—	E.P.2	Bass	—	E.P.1	Bass	—	Piano1	Bass	—	E.P.1	Bass	—	Strings	Bass
stereo			stereo			stereo			stereo			stereo			stereo			stereo		
stereo			stereo			stereo			stereo			stereo			stereo			stereo		
electric			electric			electric			electric			electric			upright			electric		
6			6			6			6			6			6			6		
5			5			5			5			5			5			5		
5			5			5			5			5			5			5		
0			0			0			0			0			0			0		
0			0			0			0			0			0			0		
0			0			0			0			0			0			0		
0			0			0			0			0			0			0		
0			0			0			0			0			0			0		
0			0			0			0			0			0			0		
0			0			0			0			0			0			0		
5			5			5			5			5			5			5		
0			0			0			0			0			0			0		
3			3			3			3			3			3			3		
Each			Each			Each			Each			Each			Each			Each		
—	+2	0	—	-4	0	—	+3	0	—	-5	0	—	0	0	—	-4	0	—	0	0
—	0	—	—	1	—	—	0	—	—	0	—	—	0	—	—	2	—	—	0	—
—	—	C2	—	—	C2	—	—	C2	—	—	C2	—	—	C2	—	—	C2	—	—	C2
—	—	Higher Note Range	—	—	Higher Note Range	—	—	Higher Note Range	—	—	Higher Note Range	—	—	Higher Note Range	—	—	Higher Note Range	—	—	Higher Note Range
off			off			off			off			off			off			off		
+12			+12			+12			+12			+12			+12			+12		
—	0	0	—	0	0	—	0	0	—	0	0	—	0	0	—	0	0	—	0	0
+12			+12			+12			+12			+12			+12			+12		
—	—	0	—	—	0	—	—	0	—	—	0	—	—	0	—	—	0	—	—	0
1			1			1			1			1			1			1		
1			1			1			1			1			1			1		
on			on			on			on			on			on			on		
off			off			off			off			off			off			off		
off			off			off			off			off			off			off		
main volume : 007			main volume : 007			main volume : 007			main volume : 007			main volume : 007			main volume : 007			main volume : 007		
1			1			1			1			1			1			1		
128			128			128			128			128			128			128		
sub volume (internal)			sub volume (internal)			sub volume (internal)			sub volume (internal)			sub volume (internal)			sub volume (internal)			sub volume (internal)		
1			1			1			1			1			1			1		
128			128			128			128			128			128			128		
Fusion Piano			Vintage EP			Dynamic EP			Ballad EP			Bell EP			Woody EP			Tremolo EP		

2			2			2			2			2			2		
mod.speed			mod.speed			mod.speed			mod.speed			mod.speed			mod.speed		
normal			normal			hard-2			hard-1			hard-1			normal		
normal			normal			hard-2			hard-1			hard-1			normal		
1			1			1			1			1			1		
128			128			128			128			128			128		
room			stage			stage			hall			hall			room		
3			2			2			3			4			2		
chorus			tremolo			chorus			chorus			symphonic			off		
3			3			4			5			4			0		
-5			+2			-9			+5			-1			-5		
0			+3			+6			-2			+1			0		
+1			-8			+6			+6			+6			+5		

			PERF. B 01			PERF. B 02			PERF. B 03			PERF. B 04			PERF. B 05		
			SINGLE	DUAL	SPLIT	SINGLE	DUAL	SPLIT	SINGLE	DUAL	SPLIT	SINGLE	DUAL	SPLIT	SINGLE	DUAL	SPLIT
<b>PLAY MODE</b>			SINGLE			SINGLE			SINGLE			SINGLE			SINGLE		
<b>VOICE</b>	MAIN		Organ1			Organ1			Organ1			Organ1			Organ1		
	SUB		—	Strings	Bass	—	Strings	Bass	—	Strings	Bass	—	Strings	Bass	—	Strings	Bass
<b>PIANO 1 STEREO/MONO</b>			stereo			stereo			stereo			stereo			stereo		
<b>PIANO 2 STEREO/MONO</b>			stereo			stereo			stereo			stereo			stereo		
<b>BASS ELECTRIC/UPRIGHT</b>			electric			electric			electric			electric			electric		
<b>ORGAN COMBINATION</b>	HOLD	16'	6			5			7			7			0		
		8'	6			7			7			5			7		
		5-1/3'	0			6			7			0			0		
		4'	2			0			0			0			0		
		2-2/3'	2			0			0			3			1		
		2'	0			0			0			5			0		
		1-1/3'	0			0			7			7			0		
		1'	0			0			0			7			0		
	RESPONSE	2			1			1			3			1			
	ATTACK	4'	0			0			0			0			0		
		2-2/3'	0			2			0			0			0		
		2'	0			0			0			0			0		
		LENGTH	3			1			4			3			5		
		EACH/FIRST	Each			Each			Each			Each			First		
<b>BALANCE</b>			—	0	0	—	0	0	—	0	0	—	-2	0	—	0	0
<b>DETUNE</b>			—	0	—	—	0	—	—	0	—	—	0	—	—	0	—
<b>SPLIT POINT</b>			—	—	C2	—	—	C2	—	—	C2	—	—	C2	—	—	C2
<b>SPLIT MAIN VOICE AREA</b>			—	—	Higher Note Range	—	—	Higher Note Range	—	—	Higher Note Range	—	—	Higher Note Range	—	—	Higher Note Range
<b>TRANPOSE</b>	ENABLE SWITCH		off			off			off			off			off		
	INTERNAL	MAIN	+12			+12			+12			+12			+12		
		SUB	—	0	0	—	0	0	—	0	0	—	0	0	—	0	0
	MIDI	MAIN	+12			+12			+12			+12			+12		
SUB		—	—	0	—	—	0	—	—	0	—	—	0	—	—	0	
<b>MIDI CHANNEL</b>	TX CHANNEL		1			1			1			1			1		
	RX CHANNEL		1			1			1			1			1		
<b>LOCAL</b>			on			on			on			on			on		
<b>CONTROLLERS</b>	PS1	ASSIGN	off			off			off			off			off		
	PS2	ASSIGN	off			off			off			off			off		
	CS	ASSIGN	main volume : 007			main volume : 007			main volume : 007			main volume : 007			main volume : 007		
		RANGE MIN	1			1			1			1			1		
		RANGE MAX	128			128			128			128			128		
	FC	ASSIGN	sub volume (internal)			sub volume (internal)			sub volume (internal)			sub volume (internal)			sub volume (internal)		
		RANGE MIN	1			1			1			1			1		
RANGE MAX		128			128			128			128			128			
<b>PERFORMANCE NAME</b>			Jazz Organ			Pop Organ			Blues Organ			Theater Organ			Accomp. Organ		

<b>CONTROLLERS</b>	PITCH BEND	RANGE	2			2			2			2			2		
	MODULATION WHEEL	ASSIGN	mod.speed			mod.speed			mod.speed			mod.speed			mod.speed		
<b>KEYBOARD SENSITIVITY</b>	INTERNAL	TYPE	normal			normal			normal			normal			normal		
	MIDI	TYPE	normal			normal			normal			normal			normal		
		RANGE MIN	1			1			1			1			1		
		RANGE MAX	128			128			128			128			128		
<b>EFFECT</b>	REVERB	TYPE	room			stage			stage			stage			stage		
		DEPTH	2			4			4			7			4		
	MODULATION	TYPE	symphonic			tremolo			symphonic			chorus			chorus		
		SPEED	0			0			4			5			3		
	INTERNAL EQUALIZER	LOW	-5			+1			0			0			0		
		MID	+4			+3			0			0			0		
		HIGH	-4			+2			0			0			+4		



PERF. B 06			PERF. B 07			PERF. B 08			PERF. B 09			PERF. B 10			PERF. B 11			PERF. B 12		
SINGLE	DUAL	SPLIT	SINGLE	DUAL	SPLIT	SINGLE	DUAL	SPLIT	SINGLE	DUAL	SPLIT	SINGLE	DUAL	SPLIT	SINGLE	DUAL	SPLIT	SINGLE	DUAL	SPLIT
DUAL			SINGLE			DUAL			SPLIT			SPLIT			SPLIT			SPLIT		
Vibes			Strings			Piano1			Piano2			E.Piano1			Vibes			Organ2		
—	E.P.1	Bass	—	Strings	Bass	—	Strings	Bass	—	Strings	Bass	—	Strings	Bass	—	Strings	Bass	—	Strings	Bass
stereo			stereo			stereo			stereo			stereo			stereo			stereo		
stereo			stereo			stereo			stereo			stereo			stereo			stereo		
electric			electric			electric			upright			electric			upright			electric		
6			6			6			6			6			6			6		
5			5			5			5			5			5			5		
5			5			5			5			5			5			5		
0			0			0			0			0			0			0		
0			0			0			0			0			0			0		
0			0			0			0			0			0			0		
0			0			0			0			0			0			0		
0			0			0			0			0			0			0		
0			0			0			0			0			0			0		
0			0			0			0			0			0			0		
5			5			5			5			5			5			5		
0			0			0			0			0			0			0		
3			3			3			3			3			3			3		
Each			Each			Each			Each			Each			Each			Each		
—	-2	0	—	0	0	—	+6	-3	—	0	0	—	0	0	—	0	-2	—	0	-3
—	2	—	—	0	—	—	2	—	—	0	—	—	0	—	—	0	—	—	0	—
—	—	C2	—	—	C2	—	—	C2	—	—	C2	—	—	C2	—	—	C2	—	—	C2
—	—	Higher Note Range	—	—	Higher Note Range	—	—	Higher Note Range	—	—	Higher Note Range	—	—	Higher Note Range	—	—	Higher Note Range	—	—	Higher Note Range
off			off			off			off			off			off			off		
+12			+12			+12			+12			+12			+12			+12		
—	0	0	—	0	0	—	0	0	—	0	0	—	0	0	—	0	0	—	0	0
+12			+12			+12			+12			+12			+12			+12		
—	—	0	—	—	0	—	—	0	—	—	0	—	—	0	—	—	0	—	—	0
1			1			1			1			1			1			1		
1			1			1			1			1			1			1		
on			on			on			on			on			on			on		
off			off			off			off			off			off			off		
off			off			off			off			off			off			off		
main volume : 007			main volume : 007			main volume : 007			main volume : 007			main volume : 007			main volume : 007			main volume : 007		
1			1			1			1			1			1			1		
128			128			128			128			128			128			128		
sub volume (internal)			sub volume (internal)			sub volume (internal)			sub volume (internal)			sub volume (internal)			sub volume (internal)			sub volume (internal)		
1			1			1			1			1			1			1		
128			128			128			128			128			128			128		
Metal Attack			Strings Orchestra			Romantic Piano			Acoustic Duo			Electric Duo			Jazz Duo			Rock Duo		

2			2			2			2			2			2			2		
mod.speed			mod.speed			mod.speed			mod.speed			mod.speed			vibrato			vibrato		
hard-2			hard-2			hard-3			hard-1			hard-2			hard-2			normal		
hard-2			hard-2			hard-3			hard-1			hard-2			hard-2			normal		
1			1			1			1			1			1			1		
128			128			128			128			128			128			128		
stage			hall			hall			stage			stage			hall			room		
2			7			3			2			1			2			4		
off			symphonic			off			off			chorus			symphonic			chorus		
2			3			0			0			5			3			4		
-1			+3			+3			0			0			-2			+2		
-3			0			+5			0			+2			0			0		
+5			+2			+1			-3			+4			0			-7		

**SYSTEM**

**PARAMETERS**

MIDI TRANSMIT ENABLE SW													PARAMETERS				
<b>SYSTEM</b>	MASTER TUNE												424.0Hz ~ 440.0Hz ~ 456.3Hz				
	REVERB												active, bypass				
	DEVICE NUMBER												off, 1~16, all				
	MIDI MERGE												on, off				
	PERFORMANCE ENABLE	MIDI CHANNEL											sys, perf				
		LOCAL ON/OFF											sys, perf				
		ASSIGN											sys, perf				
	POPOP TIME	PC SEND											off, 1-5				
		OTHERS											1-5				
STORE TYPE												auto store, non auto store					
<b>MIDI FILTER</b>	TRANSMIT	Note On/Off											on, off				
		Control Change											on, off				
		Program Change											on, off				
		Aftertouch											on, off				
		Pitch Bend Change											on, off				
		Channel Mode Message											on, off				
		Parameter Change											on, off				
		Bulk											on, off				
		FA/FB/FC											on, off				
	RECEIVE	Note On/Off											on, off				
		Control Change											on, off				
		Program Change											on, off				
		Pitch Bend Change											on, off				
		Channel Mode Message											on, off				
		Parameter Change											on, off				
		Bulk											on, off				
		<b>PROGRAM CHANGE TABLE</b>			Voice 01	Voice 02	Voice 03	Voice 04	Voice 05	Voice 06	Voice 07	Voice 08	Voice 09	Voice 10	Voice 11	Voice 12	
		TX	NUMBER														off, 1-128
BANK LSB															off, 0-127		
BANK MSB															off, 0-127		
RX	NUMBER														off/1 -128		
<b>PROGRAM CHANGE TABLE</b>			Perf. A01	Perf. A02	Perf. A03	Perf. A04	Perf. A05	Perf. A06	Perf. A07	Perf. A08	Perf. A09	Perf. A10	Perf. A11	Perf. A12			
TX	NUMBER														off, 1-128		
	BANK LSB														off, 0-127		
	BANK MSB														off, 0-127		
RX	NUMBER														off/1 -128		
<b>PROGRAM CHANGE TABLE</b>			Perf. B01	Perf. B02	Perf. B03	Perf. B04	Perf. B05	Perf. B06	Perf. B07	Perf. B08	Perf. B09	Perf. B10	Perf. B11	Perf. B12			
TX	NUMBER														off, 1-128		
	BANK LSB														off, 0-127		
	BANK MSB														off, 0-127		
RX	NUMBER														off/1 -128		

# PERFORMANCE

			SINGLE	DUAL	SPLIT	PARAMETERS
<b>PLAY MODE</b>						SINGLE, DUAL, SPLIT
<b>VOICE</b>	MAIN					(1) Piano 1 – (12) Bass
	SUB					(1) Piano 1 – (12) Bass
<b>PIANO 1 STEREO/MONO</b>						stereo, mono
<b>PIANO 2 STEREO/MONO</b>						stereo, mono
<b>BASS ELECTRIC/UPRIGHT</b>						electric, upright
<b>ORGAN COMBINATION</b>	HOLD	16'				0-7
		8'				0-7
		5-1/3'				0-7
		4'				0-7
		2-2/3'				0-7
		2'				0-7
		1-1/3'				0-7
		1'				0-7
	RESPONSE				0-7	
	ATTACK	4'				0-7
		2-2/3'				0-7
		2'				0-7
		LENGTH				0-7
		EACH/FIRST				0-7
<b>BALANCE</b>						-16+15
<b>DETUNE</b>						0-7
<b>SPLIT POINT</b>						A-1 – C7
<b>SPLIT MAIN VOICE AREA</b>						-16+15
<b>TRANPOSE</b>	ENABLE SWITCH					on, off
	INTERNAL	MAIN				-24+24
		SUB				-24+24
	MIDI	MAIN				-24+24
SUB					-24+24	
<b>MIDI CHANNEL</b>	TX CHANNEL					off, 1-16
	RX CHANNEL					off, 1-16, ALL
<b>LOCAL</b>						on, off
<b>CONTROLLERS</b>	PS1	ASSIGN				off, FA, FB, FC
	PS2	ASSIGN				off, FA, FB, FC
	CS	ASSIGN				off, rev depth, mod speed, main, sub, ....., etc.
		RANGE MIN				1-128
		RANGE MAX				1-128
	FC	ASSIGN				off, rev depth, mod speed, main, sub, ....., etc.
		RANGE MIN				1-128
		RANGE MAX				1-128
<b>PERFORMANCE NAME</b>						A-Z, a-z, 0-9, others

<b>CONTROLLERS</b>	PITCH BEND	RANGE	
	MODULATION WHEEL	ASSIGN	
<b>KEYBOARD SENSITIVITY</b>	INTERNAL	TYPE	
	MIDI	TYPE	
		RANGE MIN	
		RANGE MAX	
<b>EFFECT</b>	REVERB	TYPE	
		DEPTH	
	MODULATION	TYPE	
		SPEED	
	INTERNAL EQUALIZER	LOW	
		MID	
		HIGH	

# MIDI DATA FORMAT

## 1. MIDI DATA FLOW

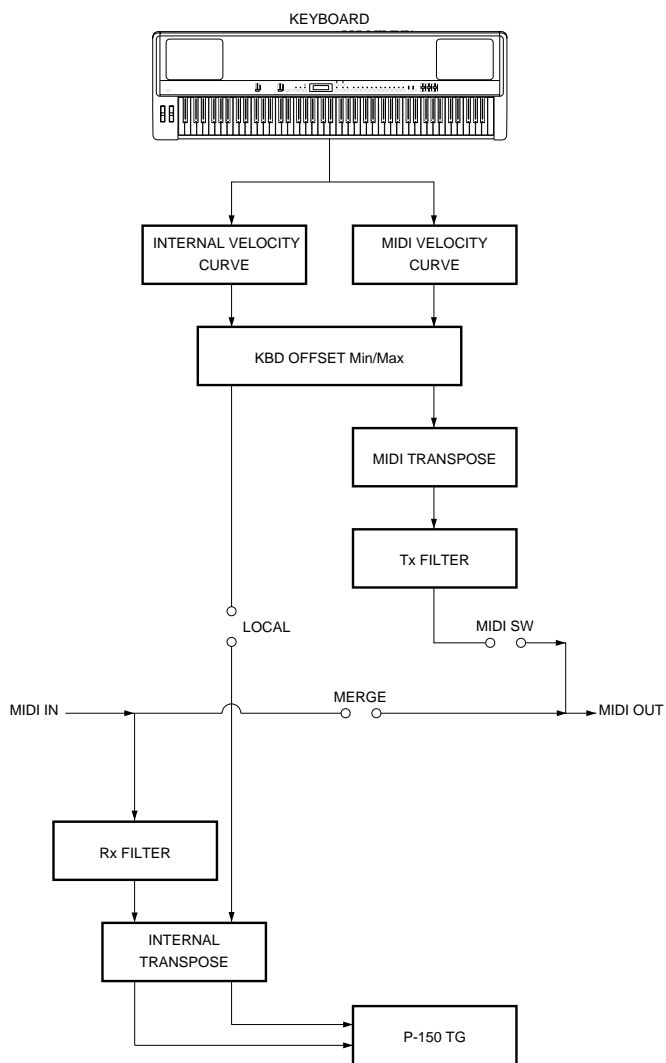

## 2. MIDI TRANSMISSION/RECEPTION

### 2.1 MIDI Transmission Condition

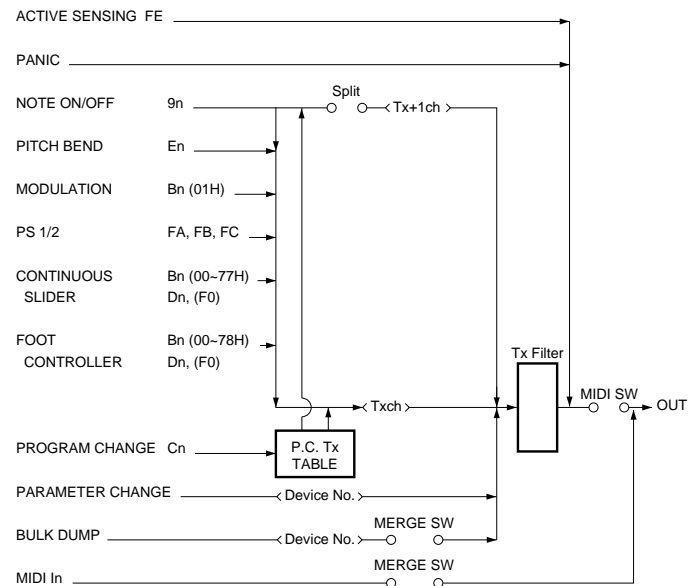

### 2.2 MIDI Reception Conditions

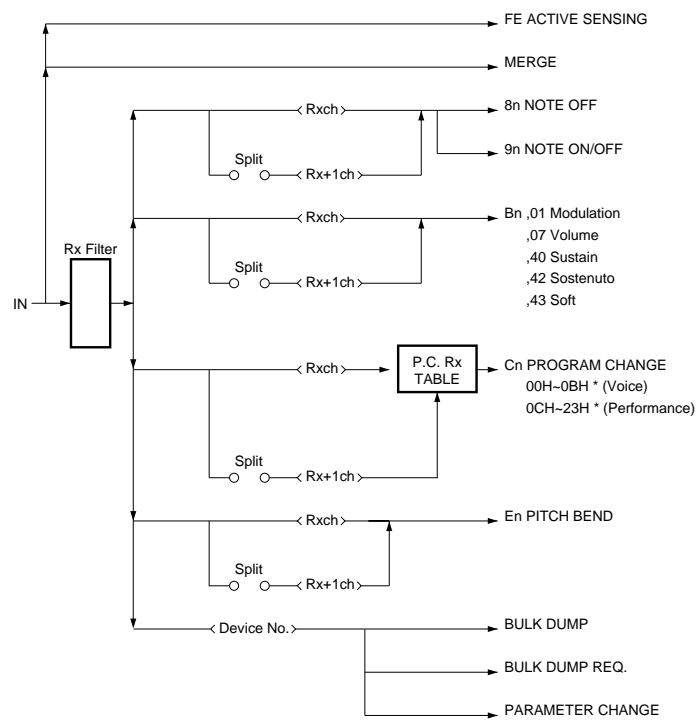

\* (Voice) : Voice Play Mode (single) only  
 \* (Performance) : Performance Play Mode only

### 3. CHANNEL MESSAGES

#### 3.1 Transmission

##### 3.1.1 Note On/Off

[9nH]->[kk]->[w]

9nH : Note on/off Status

n : Channel No.

kk : Key No.

Transpose : 21 (A-1) -108 (C7)

w : Velocity

Key on : 0-127

Key off : 0

\* Note range can be extended to 0-127 with MIDI TRANSPOSE

##### 3.1.2 Control Change

Control Change No.	Controller	Value
01	Modulation Wheel	0 - 127
64	Sustain Pedal	0 - 127
66	Sostenuto Pedal	0 - 127
67	Soft Pedal	0 - 127
0 - 119	FC	0 - 127
0 - 119	CS	0 - 127

##### 3.1.3 Program Change

- When you choose a voice in Voice Play mode, a Program Change Number corresponding to each selected button is transmitted.
- In Single mode, the Program Change Number corresponding to the button according to the transmit channel is transmitted via the transmit channel.
- In Dual mode, no sub voice Program Change Number is transmitted even if you select the sub voice.  
(Corresponding to Parameter Change (Exclusive))
- In Split mode, a Program Change Number is transmitted from the transmit channel for the main voice and on the next highest channel (Txch+1) for the sub voice according to the selected button.

##### 3.1.4 Aftertouch

When Aftertouch is assigned to the CS or FC assignable controller, Channel Pressure Data is transmitted.

##### 3.1.5 Pitch Bend

Pitch Bend is transmitted with 7-bit resolution.

##### 3.1.6 Channel Mode Message

When you press [Panic] switch (SW), <all sounds off>, <all notes off>, <reset all controllers> will be transmitted.  
See page 37 for detail.

#### 3.2 Reception

##### 3.2.1 Note On/Off

- [9nH]->[kk]->[w] n : channel no.  
 9nH : Note on/off status  
 kk : Key note  
 Reception : 0 (C-2) — 127 (G8)  
 w : Velocity  
 Key on : 1-127  
 Key off : 0

- [8nH]->[kk]->[w] n : channel no.  
 8nH : Note off Status  
 kk : Key note  
 Reception : 0 (C-2) — 127 (G8)  
 w : Velocity  
 Key off : 0-127

\* Note range can be extended to 0-127 with MIDI TRANSPOSE

\* The notes lower than 21 (A-1) and higher than 108 (C7) will repeat one-octave higher and lower, respectively.

##### 3.2.2 Control Change

[BnH]->[cc]->[w]

BnH : Control Change Status

n : Channel No.

cc : Control No.

w : Value

Control Change No.	Parameter	Value
01	Modulation Depth	0 - 127
07	Main Volume	0 - 127
64	Sustain	0 - 127
66	Sostenuto	0 - 127
67	Soft	0 - 127

##### 3.2.3 Program Change

\* In Voice Play mode if a Program Change Number from 1 to 12 is received, the voice changes to one of the following voices from the next Key On message.

RX Program Change No.	Voice
1	Piano 1
2	Piano 2
3	Piano 3
4	Piano 4
5	E. Piano 1
6	E. Piano 2
7	E. Piano 3
8	Vibes
9	Organ 1
10	Organ 2
11	Strings
12	Bass

\* In Performance Play mode if a Program Change Number from 1 to 12 is received, the mode changes to Voice Play mode. If a Program Change Number from 13 to 36 is received, the mode changes to Performance Play mode and the Performance Number changes accordingly.

RX Program Change No.	Voice
13	Perf. A01
14	Perf. A02
⋮	⋮
35	Perf. B11
36	Perf. B12

\* Any Bank Select message is ignored.

### 3.2.4 Aftertouch

Aftertouch is not received.

### 3.2.5 Pitch Bend

Only the MSB of the Pitch Bend is received.

### 3.2.6 Channel Mode

Channel Mode messages are received.

Control Change No.	Parameter	Value
78	All Sounds Off	00H
79	Reset all Controllers	00H
7B	All notes off	00H

- Channel Mode messages are received by the Receive channel while Omni Off is selected.
- All Sounds Off —  
Reception is while Omni Off is selected only.  
While Omni Off is selected, reception only occurs on the same Receive channel, and Key On sounds are quickly silenced.  
Different from All Notes Off, a dump is forcibly taken and sound is silenced even when a damper or Sostenuato causes the sound after a Key Off to continue or reduce slowly.
- All Notes Off —  
While Omni Off is selected, only those sounds that occur during Key On in the Receive Channel are silenced. Nothing is done while Omni On is selected.
- Reset All Controllers —  
While Omni Off is selected, only the Receive channel is reset to its initial value. Nothing is done while Omni On is selected.  
At reception, the status of the following items are reset to their initial values:  
Modulation Depth, Main Volume, Sustain, Soft, Sostenuato, and Pitch Bend Depth. (Reverb Depth remains unchanged.)

Modulation Depth: Off	Main Volume: Max
Sustain: Off	Soft: Off
Sostenuato: Off	Pitch Bend Depth (Center)

## 4. SYSTEM REAL TIME MESSAGES

When Start, Continue, or Stop is assigned to PS1/2 controller, System Realtime messages are transmitted.

## 5. System Exclusive Messages

### 5.1 Parameter Change

#### 5.1.1 System Setup

```

11110000    F0
01000011    43H
0001nnnn    nnnn=Device Number
00101010    2A
00100000    20
00000000    00
00000000    00
0pppppppp    pppppppp=N2
00000000    00
0vvvvvvv    vvvvvvv=Data Value
11110111    F7

```

#### 5.1.2 Voice

```

11110000    F0
01000011    43
0001nnnn    nnnn=Device Number
00101010    2A
00100010    22
00000000    00
00000000    00
0pppppppp    pppppppp=N2
00000000    00
0vvvvvvv    vvvvvvv=Data Value
11110111    F7

```

#### 5.1.3 Keyboard Mode

```

11110000    F0
01000011    43
0001nnnn    nnnn=Device Number
00101010    2A
00100110    26
00000000    00
00000000    00
0pppppppp    pppppppp=N2
00000000    00
0vvvvvvv    vvvvvvv=Data Value
11110111    F7

```

#### 5.1.4 Controller

```

11110000    F0
01000011    43
0001nnnn    nnnn=Device Number
00101010    2A
00100111    27
00000000    00
00000000    00
0pppppppp    pppppppp=N2
00000000    00
0vvvvvvv    vvvvvvv=Data Value
11110111    F7

```

### 5.1.5 MIDI Filter Table

11110000	F0
01000011	43
0001nnnn	nnnn=Device Number
00101010	2A
00101100	2C
00000000	00
00000000	00
0pppppppp	pppppppp=N2
0000000i	i=Send switch
0vvvvvvv	vvvvvvv=Data Value
11110111	F7

### 5.1.6 Program Change Transmit Table

11110000	F0
01000011	43
0001nnnn	nnnn=Device Number
00101010	2A
00101110	2E
00000000	00
0iiiiiii	iiiiiii=N1
0pppppppp	pppppppp=N2
0000000i	i=Send switch
0vvvvvvv	vvvvvvv=Data Value2
11110111	F7

### 5.1.7 Program Change Receive Table

11110000	F0
01000011	43
0001nnnn	nnnn=Device Number
00101010	2A
00101111	2F
00000000	00
00000000	00
0pppppppp	pppppppp=N2
00000000	00
0vvvvvvv	vvvvvvv=Data Value
11110111	F7

## 5.2 BULK DUMP (SYSTEM EXCLUSIVE MESSAGES)

The system is capable of sending and receiving the following types of bulk dump messages:

1. System Setup Bulk Dump
2. Voice Bulk Dump
3. Keyboard Mode Bulk Dump
4. MIDI Filter Table Bulk Dump
5. Program Change Transmit Table Bulk Dump
6. Program Change Receive Table Bulk Dump

The following three types of bulk dumps are sent and received:

1. All Bulk Dump  
All six types of bulk dumps as listed above will be sent.
2. Performance Bulk Dump  
Types 2 and 3, listed above, will be sent, for Performance Play mode Performances A01 ~ A12 or B01 ~ 12.
3. Voice Bulk Dump  
Types 2 and 3, listed above, will be sent, for Voice Play mode Voices 1 ~ 12 and Performance parameters.

The above six types of bulk dump messages can be received independently.

- For more information about bulk dump format, see page 77.
- You can assign the device number in Edit mode, System function; see page 44.
- When the device number is set to Off, bulk dump send and receive operations cannot be executed.
- When MIDI Merge (Edit mode, System function) is set to On, the P-150 cannot send bulk dump messages.
- When the device numbers of the P-150 and the external device are not matched, the P-150 cannot receive bulk dump messages.
- Bulk dump messages cannot be sent and received at the same time.
- When the MIDI Filter bulk setting (Edit mode, MIDI Filter function) is set to On, bulk dump operations cannot be executed.

## 5.3 MIDI MERGE

The MIDI Merge function enables you to merge data received from the MIDI IN terminal with data generated by the P-150, and transmits this merged data. This function works as follows:

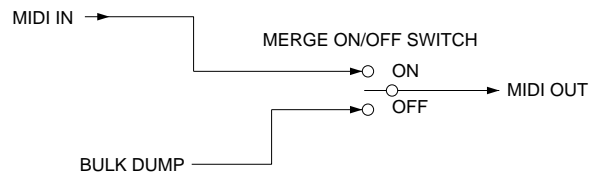

1. Some features, such as Controller, might not operate as expected because channel messages can also be transmitted on the same channel as the MIDI channel that the P-150 uses for transmission. (For example, in the case of Controller, an external device connected to MIDI OUT uses the value determined by the most recently used instrument, P-150 or an external device connected to MIDI IN. The sounds from the P-150's tone generator might sometimes cut off when receiving an All Notes Off message.)
  2. A received Active Sensing message is never transmitted.
  3. When an interrupt of the received Active Sensing is detected, transmission of Active Sensing through MIDI OUT is interrupted after 500msec.
  4. When the P-150 receives 32 or more bytes of System Exclusive Messages, the MIDI messages transmitted by the P-150 might cause an interruption.  
(When System Exclusive Messages from MIDI IN are received, the MIDI messages that the P-150 attempted to transmit are held temporarily; however, if the data exceeds 31 bytes, the hold is released and after an EOX is forcibly transmitted, the P-150 MIDI messages are transmitted. In this case the data bytes being received are not transmitted until reception of the status byte of non-System Realtime Messages, and are discarded.)
  5. When the MIDI Merge function is On, Bulk Dumps cannot be sent from the P-150.
  6. After the P-150 receives one status byte of the System Exclusive Messages, if the status of other channel messages, etc., are received before an EOX is received, the EOX is transmitted and other messages (for example, channel messages) are separated from the System Exclusive Messages and are transmitted.
- \* When MIDI Merge is On, the MIDI Panic feature does not work.

## 5.4 MIDI Panic

With the P-150, pressing the [MIDI]+[REVERB]+[MODULATION] buttons suppresses MIDI transmission as an emergency method to shut down all sound.

- MIDI transmission  
The following messages are transmitted :  
Modulation Depth Off, Sustain Pedal Off, All Sound Off, All Note Off, Reset All Controllers, Pitch Bend Depth (Center) and Channel Pressure Off, for all channels.
  - MIDI Panic transmission is not possible when the MIDI Merge function is On.
  - MIDI Panic transmission is not possible during sending/receiving bulk data.
- \* The MIDI Panic feature is an emergency measure of last resort, so sound sometimes might not stop.

## 6. PARAMETER CHANGE TABLE

### 6.1 System Setup

F0H, 43H, 1nH, 2AH, 20H, 00H, 00H, N2H, 00H, V2H, F7H

n : Device Number  
N2H : Parameter Number  
V2H : Parameter Value 2

	N2	data name	V2 (data range)	note
0	00	MTUNE	-64 – +63 (o/b)	Master Tuning
1	01	MENABSW	off/on	MIDI Tx Enable SW
2	02	MREVS	bypass/active	Reverb Bypass SW
3	03	MERGSW	off/on	Merge SW
4	04	PERFCHSW	sys/perf	Performance Channel Enable SW
5	05	PERFLOSW	sys/perf	Performance Local Enable SW
6	06	PERFASSSW	sys/perf	Performance Controller Assign Enable SW
7	07	POPUPPC	off, 1, ....., 5	Popup Time P.C. Send
8	08	POPUPOTHER	1, ....., 5	Popup Time Other
9	09	STORETYPE	auto store/ non auto store	Store Type
10	0A	DEVNUM	1–16, all, off	Device Number

### 6.2 Voice

F0H, 43H, 1nH, 2AH, 22H, 00H, 00H, N2H, 00H, V2H, F7H

n : Device Number  
N2H : Parameter Number  
V2H : Parameter Value 2

	N2	data name	V2 (data range)	note
0	00	PBRANGE	0–12	PB Range
1	01	MODASS	0–3	Modulation Wheel Assign
2	02	INTVELCRV	0–9	Int. KBD Sens.Type
3	03	RXVELCRV	0–9	MIDI KBD Sens. Type
4	04	VELMIN	0–127	KBD Range Min
5	05	VELMAX	0–127	KBD Range Max
6	06	REVTYP	0–3	Effect Reverb Type
7	07	REVDPT	0–7	Effect Reverb Depth
8	08	MODTYP	0–3	Effect Modulation Type
9	09	MODSPD	0–7	Effect Modulation Speed
10	0A	INTEQL	-16 – +16 (o/b)	Internal Equalizer Low
11	0B	INTEQM	-16 – +16 (o/b)	Internal Equalizer Mid
12	0C	INTEQH	-16 – +16 (o/b)	Internal Equalizer High

### 6.3 Keyboard Mode

F0H, 43H, 1nH, 2AH, 26H, 00H, 00H, N2H, 00H, V2H, F7H

n : Device Number  
N2H : Parameter Number  
V2H : Parameter Value 2

	N2	data name	V2 (data range)	note
0	00	PMODE	0–2	Play Mode 0: Single/ 1: Dual/ 2: Split
1	01	VMAIN	0–11	Main Voice Number *1 2*
2	02	VDUAL	0–11	Sub Voice Number (Dual) *1
3	03	VSPLIT	0–11	Sub Voice Number (Split) 2*
4	04	VP1MONO	stereo/mono	Piano1 stereo/mono
5	05	VP2MONO	stereo/mono	Piano2 stereo/mono
6	06	VBASSEW	elec./upright	Bass elec./upright
7	07	ORGCM16	0–7	Organ Combination 16'
8	08	ORGCM8	0–7	Organ Combination 8'
9	09	ORGCM513	0–7	Organ Combination 5+1/3'
10	0A	ORGCM4	0–7	Organ Combination 4'
11	0B	ORGCM223	0–7	Organ Combination 2+2/3'
12	0C	ORGCM2	0–7	Organ Combination 2'
13	0D	ORGCM113	0–7	Organ Combination 1+1/3'
14	0E	ORGCM1	0–7	Organ Combination 1'
15	0F	ORGATK4	0–7	Organ Attack 4'
16	10	ORGATK223	0–7	Organ Attack 2+2/3'
17	11	ORGATK2	0–7	Organ Attack 2'
18	12	ORGATKLEN	0–7	Organ Attack Length

19	13	ORGRESPONSE	0–7	Organ Combination Response
20	14	ORG.EF	each/first	Organ Attack Each/First
21	15	reserve		
22	16	reserve		
23	17	reserve		
24	18	reserve		
25	19	BAL DUAL	-16 – +15 (o/b)	Dual Balance
26	1A	BAL SPLIT	-16 – +15 (o/b)	Split Balance
27	1B	DETUNE	0–7	Dual Detune
28	1C	SPOINT	A-1–C7	Split Point
29	1D	SAREA	upper/lower	Split Main Voice Area
30	1E	SFTSW	off/on	Transpose Switch
31	1F	SFTMAIN	-24 – +24 (o/b)	Main Voice Transpose
32	20	SFTSUB D	-24 – +24 (o/b)	Sub Voice Transpose (Dual)
33	21	SFTSUB S	-24 – +24 (o/b)	Sub Voice Transpose (Split)
34	22	SFTMAIN MD	-24 – +24 (o/b)	Main Voice MIDI Transpose
35	23	SFTSUB MD	-24 – +24 (o/b)	Sub Voice MIDI Transpose
36	24	LOCALSW	off/on	Local on/off Switch
37	25	TXCH	0–15, off	TX Channel
38	26	RXCH	0–15, off, all	Rx Channel
39	27	reserve		
40	28	ASSPS1	0–3	PS1 Assign
41	29	ASSPS2	0–3	PS2 Assign
42	2A	ASSCS	0–126	CS Assign
43	2B	ASSCSMIN	0–127	CS Range Min
44	2C	ASSCSMAX	0–127	CS Range Max
45	2D	ASSFC	0–126	FC Assign
46	2E	ASSFCMIN	0–127	FC Range Min
47	2F	ASSFCMAX	0–127	FC Range Max
48	30	PERFNAME1	32–127	Performance Name 1
49	31	PERFNAME2	32–127	Performance Name 2
50	32	PERFNAME3	32–127	Performance Name 3
51	33	PERFNAME4	32–127	Performance Name 4
52	34	PERFNAME5	32–127	Performance Name 5
53	35	PERFNAME6	32–127	Performance Name 6
54	36	PERFNAME7	32–127	Performance Name 7
55	37	PERFNAME8	32–127	Performance Name 8
56	38	PERFNAME9	32–127	Performance Name 9
57	39	PERFNAME10	32–127	Performance Name 10
58	3A	PERFNAME11	32–127	Performance Name 11
59	3B	PERFNAME12	32–127	Performance Name 12
60	3C	PERFNAME13	32–127	Performance Name 13
61	3D	PERFNAME14	32–127	Performance Name 14
62	3E	PERFNAME15	32–127	Performance Name 15
63	3F	PERFNAME16	32–127	Performance Name 16

\*1 Not possible for Dual mode with Organ 1 and another voice.

\*2 Execute transmission only.

### 6.4 Controller

F0H, 43H, 1nH, 2AH, 27H, 00H, 00H, N2H, 00H, V2H, F7H

n : Device Number  
N2H : Parameter Number  
V2H : Parameter Value 2

	N2	data name	V2 (data range)	note
0	00	reserve		
1	01	reserve		
2	02	VOL TTL	0–127	Total Volume
3	03	VAL MAIN	0–127	Main Voice Volume
4	04	VUL SUB	0–127	Sub Voice Volume
5	05	VIBSPD	0–127	Vibrato Speed Control
6	06	REVDEP	0–7	Reverb Depth Control
7	07	MODSPD	0–7	Modulation Speed Control

\* Transmitted and received when allocated to the assignable Controller.



## 6.5 MIDI Filter

FOH, 43H, 1nH, 2AH, 2CH, 00H, 00H, N2H, 00H, 2VH, F7H  
 n : Device Number  
 N2H : Parameter Number  
 V2H : Parameter Value 2

	N2	data name	V2 (data range)	note
0	00	TXMFILNOTE	off/on	Tx MIDI Filter Note on/off
1	01	TXMFILCTRL	off/on	Tx MIDI Filter Ctrl Change
2	02	TXMFILPC	off/on	Tx MIDI Filter Prog. Change
3	03	TXMFILAFT	off/on	Tx MIDI Filter Aftertouch
4	04	TXMFILPB	off/on	Tx MIDI Filter Pitch Bend
5	05	TXMFILCH	off/on	Tx MIDI Filter Channel Message
6	06	TXMFILPRM	off/on	Tx MIDI Filter Exclusive
7	07	TXMFILBULK	off/on	Tx MIDI Filter Bulk
8	08	TXMFILSYS	off/on	Tx MIDI Filter FA/FB/FC
9	09	RXMFILNOTE	off/on	Rx MIDI Filter Note on/off
10	0A	RXMFILCTRL	off/on	Rx MIDI Filter Ctrl Change
11	0B	RXMFILPC	off/on	Rx MIDI Filter Prog. Change
12	0C	reserve		
13	0D	RXMFILPB	off/on	Rx MIDI Filter Pitch Bend
14	0E	RXMFILCH	off/on	Rx MIDI Filter Channel Message
15	0F	RXMFILPRM	off/on	Rx MIDI Filter Exclusive
16	10	RXMFILBULK	off/on	Rx MIDI Filter Bulk

## 6.6 Program Change Transmit Table

FOH, 43H, 1nH, 2AH, 2EH, 00H, N1H, N2H, V1H, V2H, F7H  
 n : Device Number  
 N1H : Parameter Number  
 N2H : Parameter Number  
 V1H : Parameter Value 1 (= 1 don't send P.C.)  
 V2H : Parameter Value 2

	N2	data name	V2 (data range)	note
0	00	TXPGM1	0-127	Voice 01
:	:	:	0-127	:
:	:	:	0-127	:
11	03	TXPGM12	0-127	Voice 12
12	04	TXPGM13	0-127	Perf. A01
:	:	:	0-127	:
:	:	:	0-127	:
23	17	TXPGM24	0-127	Perf. A12
24	18	TXPGM25	0-127	Perf. B01
:	:	:	0-127	:
:	:	:	0-127	:
35	23	TXPGM36	0-127	Perf. B12

N1	data name
00	TX P.C. Data
01	Bank Select MSB
02	Bank Select LSB

## 6.7 Program Change Receive Table

FOH, 43H, 1nH, 2AH, 2FH, 00H, 00H, N2H, 00H, V2H, F7H  
 n : Device Number  
 N2H : Parameter Number  
 V2H : Parameter Value 2

	N2	data name	V2 (data range)	note
0	00	RXPGM1	Voice 01-Perf. B12, off	Program Change Number 1
1	01	RXPGM2	Voice 01-Perf. B12, off	Program Change Number 2
2	02	RXPGM3	Voice 01-Perf. B12, off	Program Change Number 3
:	:	:	:	:
:	:	:	:	:
:	:	:	:	:
126	7E	RXPGM127	Voice 01-Perf. B12, off	Program Change Number 127
127	7F	RXPGM128	Voice 01-Perf. B12, off	Program Change Number 128

## 7. BULK DUMP

### 7.1 System Setup & Dump Request

SYSTEM SETUP	
	data
0	FOH
1	43H
2	0NH
3	7AH
4	□ bytes
5	□
6	S
7	K
8	-
9	-
10	2
11	4
12	9
13	0
14	S
15	Y
16	□ 00H
↓	
31	
Supplement: Parameter Change	
<b>1. 00H-0AH of system setup</b>	
32	MTUNE
↓	
42	DEVNUM
43	check_sum
44	F7H

DUMP REQUEST	
	data
0	FOH
1	43H
2	2NH
3	7AH
4	S
5	K
6	-
7	-
8	2
9	4
10	9
11	0
12	S
13	Y
14	□ 00H
↓	
29	
30	F7H

## 7.2 Voice

type 1: 00H

type 2: Voice Number

type2	VOICE NUMBER
00H	Voice 01
01H	Voice 02
02H	Voice 03
03H	Voice 04
04H	Voice 05
05H	Voice 06
06H	Voice 07
07H	Voice 08
08H	Voice 09
09H	Voice 10
0AH	Voice 11
0BH	Voice 12
0CH	Perf. A01 Voice
0DH	Perf. A02 Voice
0EH	Perf. A03 Voice
0FH	Perf. A04 Voice
10H	Perf. A05 Voice
11H	Perf. A06 Voice
12H	Perf. A07 Voice
13H	Perf. A08 Voice
14H	Perf. A09 Voice
15H	Perf. A10 Voice
16H	Perf. A11 Voice
17H	Perf. A12 Voice
18H	Perf. B01 Voice
19H	Perf. B02 Voice
1AH	Perf. B03 Voice
1BH	Perf. B04 Voice
1CH	Perf. B05 Voice
1DH	Perf. B06 Voice
1EH	Perf. B07 Voice
1FH	Perf. B08 Voice
20H	Perf. B09 Voice
21H	Perf. B10 Voice
22H	Perf. B11 Voice
23H	Perf. B12 Voice

VOICE	
	data
0	FOH
1	43H
2	0NH
3	7AH
4	bytes
5	
6	S
7	K
8	-
9	-
10	2
11	4
12	9
13	0
14	V
15	0
16	
↓	00H
29	
30	type 1
31	type 2
Supplement: Parameter Change	
<b>2. 00H-12H of Voice</b>	
32	PBRANGE
↓	
44	INTEQH
45	check_sum
46	F7H

DUMP REQUEST	
	data
0	FOH
1	43H
2	2NH
3	7AH
4	S
5	K
6	-
7	-
8	2
9	4
10	9
11	0
12	V
13	0
14	
↓	00H
27	
28	type 1
29	type 2
30	F7H

### 7.3 Keyboard Mode

type 1: 00H

type 2: Performance Number

type2	PERFORMANCE NUMBER
00H	Perf. A01
:	:
:	:
0BH	Perf. A12
0CH	Perf. B01
:	:
:	:
17H	Perf. B12
18H	Voices

KEYBOARD MODE	
	data
0	F0H
1	43H
2	0NH
3	7AH
4	bytes
5	S
6	K
7	-
8	-
9	2
10	4
11	9
12	0
13	K
14	B
15	↓
16	00H
29	↓
30	type 1
31	type 2

Supplement: Parameter Change  
**3. 00H-3FH of Keyboard Mode**

32	PMode
↓	
95	PERFNAME 16

96	check_sum
97	F7H

DUMP REQUEST	
	data
0	F0H
1	43H
2	2NH
3	7AH
4	S
5	K
6	-
7	-
8	2
9	4
10	9
11	0
12	K
13	B
14	↓
15	00H
27	↓
28	type 1
29	type 2
30	F7H

### 7.4 MIDI Filter Table Bulk Dump

P.C. TX TABLE	
	data
0	F0H
1	43H
2	0NH
3	7AH
4	bytes
5	S
6	K
7	-
8	-
9	2
10	4
11	9
12	0
13	M
14	F
15	↓
16	00H
31	↓

Supplement: Parameter Change  
**4. 00H-10H of MIDI Filter Table**

32	TXMFILNOTE
↓	
48	RXMFILBULK

49	check_sum
50	F7H

DUMP REQUEST	
	data
0	F0H
1	43H
2	2NH
3	7AH
4	S
5	K
6	-
7	-
8	2
9	4
10	9
11	0
12	M
13	F
14	↓
15	00H
29	↓
30	F7H

### 7.5 Program Change Transmit Table Bulk Dump

type 1: 00H  
type 2: Voice No.

type 2	VOICE NUMBER
00H	P.C.Data
01H	Bank Select MSB
02H	Bank Select LSB

P.C. Tx TABLE	
	data
0	FOH
1	43H
2	0NH
3	7AH
4	bytes
5	S
6	K
7	-
8	-
9	2
10	4
11	9
12	0
13	P
14	T
15	00H
16	↓
29	type 1
30	type 2
31	

Supplement: Parameter Change 5. 00H-35H of Program Change Transmit Table	
	data
32	TXPGM1 (MSB)
33	TXPGM1 (LSB)
↓	
102	TXPGM36 (MSB)
103	TXPGM36 (LSB)
104	check_sum
105	F7H

DUMP REQUEST	
	data
0	FOH
1	43H
2	2NH
3	7AH
4	S
5	K
6	-
7	-
8	2
9	4
10	9
11	0
12	P
13	T
14	00H
↓	
27	type 1
28	type 2
29	F7H
30	

### 7.6 Program Change Receive Table Bulk Dump

P.C. Tx TABLE	
	data
0	FOH
1	43H
2	0NH
3	7AH
4	bytes
5	S
6	K
7	-
8	-
9	2
10	4
11	9
12	0
13	P
14	R
15	00H
16	↓
31	

Supplement: Parameter Change 6. 00H-7FH of Program Change Receive Table	
	data
32	RXPGM1
↓	
159	RXPGM128
160	check_sum
161	F7H

DUMP REQUEST	
	data
0	FOH
1	43H
2	2NH
3	7AH
4	S
5	K
6	-
7	-
8	2
9	4
10	9
11	0
12	P
13	R
14	00H
↓	
29	type 1
30	type 2
30	F7H

Function ...	Transmitted	Recognized	Remarks
:Basic Default	: 1 - 16	: 1 - 16	: memorized
:Channel Changed	: 1 - 16	: 1 - 16	:
:Mode Default	: Mode 3	: Mode 1 , 3	: memorized
:Mode Messages	: x	: x	:
:Altered	: *****	: x	:
:Note Number : True voice	: 0 - 127 : *****	: 1 - 127 : 21 - 108	:
:Velocity Note ON	: o 9nH,v=1-127	: o v=1-127	:
:Note OFF	: x 9nH,v=0	: x	:
:After Key's	: x	: x	:
:Touch Ch's	: o	: x	:
:Pitch Bender	: o	: o 0 - 12 semi	: 7 bit resolution:
:Control Change	: 0,32 : o Bank Select : 1 : o M.Wheel : 7 : o Foot Volume : 64 : o Sustain : 66 : o Sostenuto : 67 : o Soft : 1 - 119 : o Assignable	: x : o : o : o : o : o : x	:
:Control Change	: 120 : o	: *1: o	: All Sound Off
:Control Change	: 121 : o	: *1: o	: Reset All Contls:
:Program Change : True #	: o 0 - 127 : *****	: o 0 - 127 : o 0 - 11	: assignable
:System Exclusive	: o	: o	: voice etc.
:System : Song Pos	: x	: x	:
:System : Song Sel	: x	: x	:
:Common : Tune	: x	: x	:
:System :Clock	: x	: x	:
:Real Time :Commands	: o	: x	:
:Aux :Local ON/OFF	: x	: x	:
:Aux :All Notes OFF	: o	: *1: o	:
:Mes- :Active Sense	: o	: o	:
:sages:Reset	: x	: x	:
:Notes:	Received messages are merged to MIDI OUT when MIDI merge Switch is on.		
:	*1 = Transmit if PANIC Switch is ON.		
Mode 1	: OMNI ON, POLY	Mode 2	: OMNI ON, MONO
Mode 3	: OMNI OFF, POLY	Mode 4	: OMNI OFF, MONO
			o : Yes
			x : No

# INDEX

<hr/>	
A	
APPENDIX .....	55
Auto Store.....	45
<hr/>	
B	
Backup Battery .....	2
Balance (Dual).....	27
Balance (Split) .....	30
Bank Select (PC Table) .....	47
Bass, Electric/Upright .....	21
Blank Chart.....	64
Bulk Dump .....	55
<hr/>	
C	
Channel .....	47
Continuous Slider (CS).....	48
CS FC.....	48
<hr/>	
D	
Demo Songs .....	17
Detune .....	27
Device Number.....	44
Dual Mode .....	26
<hr/>	
E	
EDIT MODE.....	42
Edit Menu Tree .....	42
Equalizer (Internal) .....	52
Equalizer (Panel) .....	24
Error Messages .....	60
<hr/>	
F	
Foot Controller (FC).....	48
<hr/>	
G	
GETTING STARTED .....	14
<hr/>	
I	
Initialize.....	56
Internal Control Functions .....	49
Internal Equalizer.....	52
<hr/>	
K	
Keyboard Sensitivity .....	51
<hr/>	
L	
Local .....	48
<hr/>	
M	
Main and Sub Voices.....	25, 32
Master Tune .....	44
MIDI (Using MIDI).....	57
MIDI Control Change Messages .....	49
MIDI Data Format .....	72
MIDI Filter .....	46
MIDI Implementation Chart.....	81
MIDI Merge.....	44
MIDI Panic.....	37
MIDI System Connections .....	58
MIDI Transmit Enable .....	36
Modulation .....	23, 52
Modulation Wheel Assign .....	51
<hr/>	
N	
Name (Performance) .....	50
<hr/>	
O	
Organ Combination .....	50
<hr/>	
P	
Panel Switch (PS).....	50
PERFORMANCE PLAY MODE.....	38
Performance Enable.....	45
Performance Name .....	50
Performance Parameters .....	12
Pitch Bend Range.....	51
Play Modes.....	10
Popup Time .....	45
PRECAUTIONS.....	2
Preset Performance List .....	64
Preset Voice List.....	63
Program Change (PC) Table.....	46
Program Change Receive .....	47
Program Change Transmit .....	46
<hr/>	
R	
REAR PANEL.....	9
Receive Filter.....	46
Reverb .....	22, 52
Reverb Bypass .....	44
<hr/>	
S	
Single Mode.....	20
Specifications .....	63
Split Mode.....	28
Split point.....	29, 31
Stereo/Mono Piano .....	21
STORE .....	53
Store Type .....	45
System.....	44
System Settings.....	13
<hr/>	
T	
Transmit Filter.....	46
Transpose.....	33
Troubleshooting.....	61
<hr/>	
U	
UPPER PANEL .....	4
<hr/>	
V	
Velocity Curves.....	52
VOICE PLAY MODE .....	19
Voice Parameters .....	11
Voices and Polyphony .....	20

**YAMAHA**  
YAMAHA CORPORATION