

YAMAHA

INTEGRATED

MIXER

EM-85

INSTRUCTION MANUAL

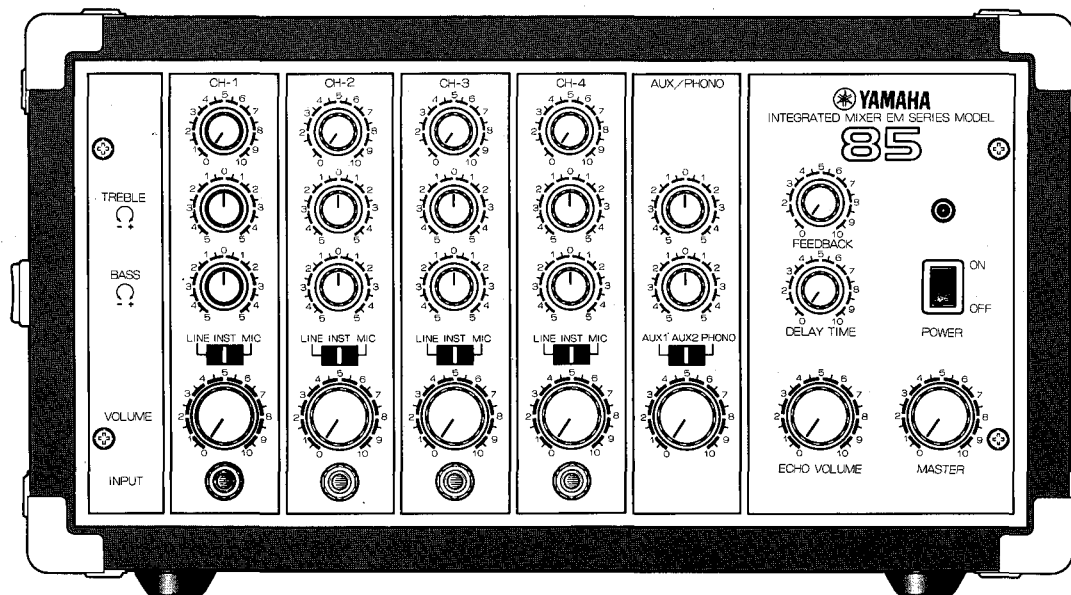

This instruction manual was prepared to assist you in getting the most out of your EM-85. While you may already have begun using the unit, we urge you to read this manual thoroughly, and to re-read it as you become more familiar with the EM-85's features and functions.

WARNING: To reduce the risk of fire or electric shock, do not expose this appliance to rain or moisture.

TABLE OF CONTENTS

INTRODUCTION	1
SPECIFICATIONS	2
BRIEF OPERATING INSTRUCTIONS	
FRONT PANEL	3
REAR PANEL	5
GETTING THE MOST FROM THE BUILT-IN	
ANALOG DELAY LINE	7
SETTING UP	7
APPLICATIONS	8
BLOCK DIAGRAM	10

INTRODUCTION

The Yamaha EM-85 is an integrated mixer with a built-in power amplifier, 200 millisecond analog delay line, and RIAA phono preamp. There are four regular mic/instrument/line input channels. Each of these channels has a two-frequency equalizer, an echo (delay) send, a 3-position input selector for use with mics, instruments and lines, and a rotary volume control. A fifth input channel is switchable for either of two auxiliary line inputs or a phonograph input (mono or stereo). The mixer's solid state power amplifier

delivers 45 watts (RMS) into 8 ohms or 70 watts into 4 ohms, and there are two parallel speaker outputs, each having both a phone jack and push-terminals. This provides the greatest compatibility, speed and ease of set up. There are also line output and recorder output jacks for feeding additional amplifiers, other mixers, tape recorders, and so forth.

NOTE: In this manual, where a specific signal level is described in dB, 0dB is referenced to 0.775 volts RMS.



SPECIFICATIONS

GENERAL SPECIFICATIONS

MAXIMUM OUTPUT POWER	70 watts into 4 ohms, or 45 watts into 8 ohms, continuous average sine wave (RMS).
FREQUENCY RESPONSE	± 1dB, 30 Hz to 10 kHz or +1, -4dB, 20 Hz to 20 kHz, (35W, 4Ω) @35 watts into 4 ohms.
TOTAL HARMONIC DISTORTION (THD)	Less than 0.5% 50 Hz to 10 kHz, Less than 0.2% @1 kHz, @35 watts into 4 ohms.
INTERMODULATION DISTORTION	Less than 0.5%, (70 Hz : 70 kHz = 4 : 1) @35 watts into 4 ohms.
* HUM and NOISE (20 Hz to 20 kHz, 150 ohms source)	** -116dB Equivalent input noise; -38dB residual output noise, Master Volume and one Input Volume at max. -42dB residual output noise, Master Volume at max and all Input Volume controls at min.
MAXIMUM VOLTAGE GAIN (Input Selectors set at Mic position).	77dB, Channel In to Speaker Out. 50dB, Channel In to Line Out. 47dB, Channel In to Record Out. 47dB, Aux In to Speaker Out. 77dB, Phono In to Speaker Out.
EQUALIZATION	BASS ± 12dB @100 Hz, shelving. TREBLE ± 12dB @10kHz, shelving.
CROSSTALK	-60dB @1 kHz, adjacent inputs.
ANALOG DELAY LINE	100 to 200 milliseconds, continuously variable, and with variable feedback.
POWER REQUIREMENTS	US & Canadian models 120 volts, 50/60 Hz General model 110, 130, 220 or 240 volts, 50/60 Hz
POWER CONSUMPTIONS	US & Canadian models 120 watts General model 185 watts
DIMENSIONS	16-1/8" W x 9-1/2" D x 8-3/4" H, (410 mm W x 242 mm D x 225 mm H).
WEIGHT	20 pounds (9.2 kg).

* Compensated with a 6dB/octave filter @12.47 kHz.

** In these specifications, 0dB is referenced to 0.775 volts RMS. Specifications are subject to change without notice.

INPUT CHARACTERISTICS

Connection	Actual Load Impedance	For Use with Nominal	Input Level		Connector
			Nominal	Max. before clip	
INPUTS (1 ~ 4CH) MIC INST LINE	50kΩ	150 ~ 3kΩ Sources	-50dB (2.5mV) -35dB (14mV) -20dB (78mV)	-22dB (62mV) - 7dB (346mV) + 8dB (1.93V)	Phone Jack
AUX INPUTS (CH5) AUX IN 1 AUX IN 2 PHONO	30kΩ 30kΩ 47kΩ	5kΩ 5kΩ mag. cart.	-20dB (78mV) -20dB (78mV) -50dB (2.5mV)	- - -22dB (62mV)	Phone Jack 2 x Pin Jack 2 x Pin Jack

OUTPUT CHARACTERISTICS

Connector	Actual Source Impedance	For Use with Nominal	Output Level		Connector
			Nominal	Max. before clip	
SPEAKER 1 and/or 2	0.2Ω	4Ω & up	-	4Ω 70W 8Ω 45W	Phone Jack Terminals
LINE OUT	100Ω	10kΩ & up	0dB (775mV)	-	Phone Jack
REC. OUT	2.2kΩ	10kΩ & up	-3dB (550mV)	+15dB (4.94V)	Pin Jack

In these specifications, 0dB is referenced to 0.775 volts RMS.

BRIEF OPERATING INSTRUCTIONS

NOTE: Make all signal and speaker connections before turning on the AC POWER switch.

FIG. 1. FRONT PANEL

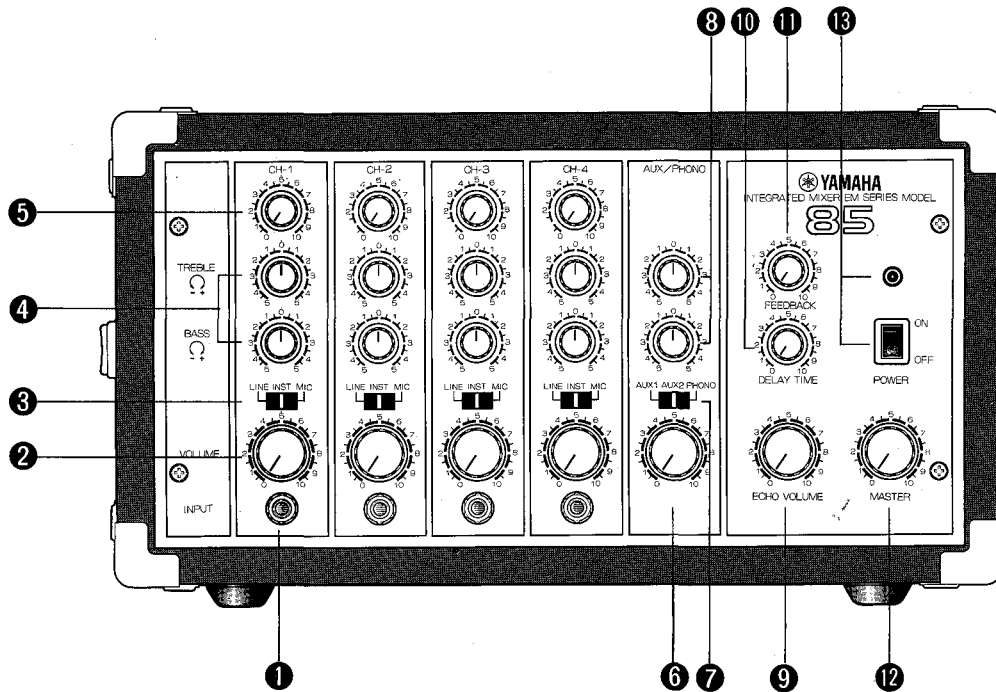

INPUT CHANNEL (Typical of Input channels 1 through 4)

① Input Jack

This 1/4" (6.3 mm) tip-sleeve phone jack accepts signal for the channel input. The inputs are unbalanced.

② Volume

This control sets the channel's mix level.

③ Input Selector Switch

This slide-switch adjusts the input jack's sensitivity for best results with different input sources. "Line" position is for tape machine outputs and high level synthesizers with nominal -20 dB output level. "Inst" position is for guitars, electric pianos, and other keyboards with nominal -35 dB output level. "Mic" position is for high or low impedance microphones with nominal -50 dB output level.

④ Bass and Treble

Two knobs per input channel allow ± 12 dB of equalization (tone control), with "flat" response at center position. The knee of the EQ curve is 100 Hz for the Bass control, and 10 kHz for the Treble control.

⑤ Echo

This knob feeds the mix bus that drives the built-in analog delay line. The feed is post-EQ and Volume controls.

BRIEF OPERATING INSTRUCTIONS

AUX / PHONO CHANNEL

Note: Input jacks for this fifth channel are located on the EM-85 rear panel.

⑥ Volume

This control sets the auxiliary input or phono input mix level.

⑦ Input Selector Switch

This slide-switch selects any of three input sources to the channel: Aux 1 is a 1/4" (6.3 mm) tip-sleeve phone jack that accepts nominal -20 dB signals. Aux 2 is a pair of RCA-type pin jacks (phono jacks) that also accept nominal -20 dB signals. Either or both of the Aux 2 jacks may be used since both are wired to the Aux 2 input point. PHONO is another pair of RCA-type pin jacks, both of which feed the same PHONO input point. PHONO is designed for -50 dB nominal level, and is RIAA equalized to be compatible with magnetic phonograph cartridges, either mono or stereo.

⑧ Bass and Treble

These two knobs are identical to the input channel EQ controls, except they affect only the selected auxiliary input source.

MASTER CONTROLS

⑨ Echo Volume

This control sets the level of the signal from the built-in analog delay line that is mixed back with the "direct" sound in the Speaker, Record and Line outputs. (It is an echo return control.)

⑩ Delay Time

This control continuously varies the length of delay from 100 to 200 milliseconds.

⑪ Feedback

This control adjusts the amount of output from the delay line which is mixed back into the delay circuitry. Increasing the amount of Feedback lengthens the duration of an echo. If Feedback is set high enough, oscillation (howl or run-away echo) can occur. This undesirable condition can be remedied by lowering the Feedback setting.

⑫ Master

This control adjusts the level at the Speaker outputs and the Line output, but does not affect the Record output level.

⑬ Power Switch and Indicator

A rocker switch turns the AC power On and Off. The red pilot lamp above the switch is On when power is On.

FIG. 2. REAR PANEL

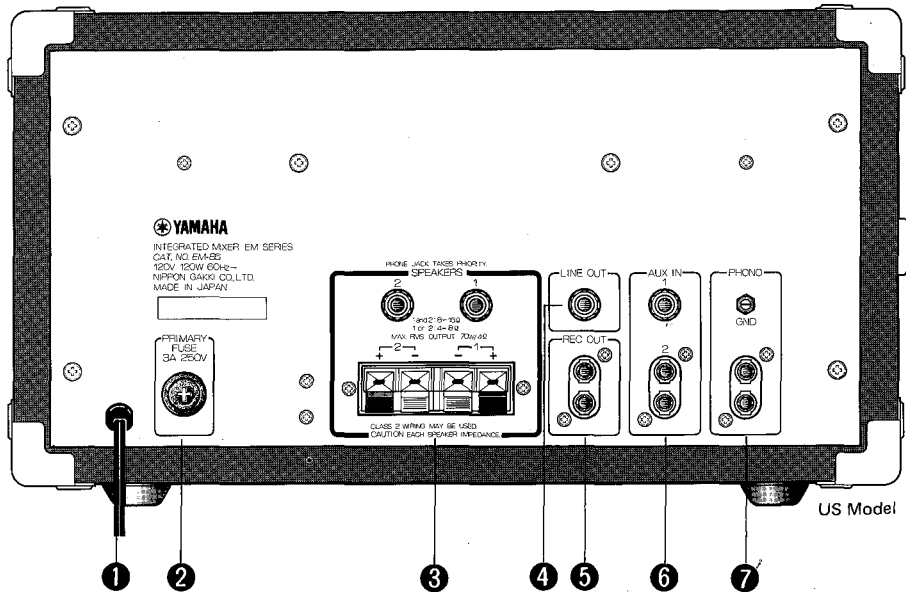

REAR PANEL

① AC Power Cord

This 3-wire cord is for connection to any 120 volts AC, 50 or 60 Hz grounded outlet of US & Canadian models, and to any one of 110, 130, 220 and 240 volts AC, 50/60 Hz of General model.

② Fuse

To replace a fuse, unscrew the fuse holder cap with a phillips or slot-blade driver. Use a 3 amp 250 volts type fuse with US & Canadian models, and 1.6 amp 250 volts type fuse General model. If the fuse blows repeatedly, check for a short or overload in the speaker connections, or consult the Service instructions on the back cover of this manual.

③ Speaker Outputs 1 & 2

There are two sets of parallel-wired speaker outputs (#1 and #2), each of which has a 1/4" (6.3mm) tip/sleeve phone jack and a pair of push-terminals. If a phone jack is used, the associated push terminals are automatically disconnected from the amplifier. The minimum overall load impedance is 4 ohms.

When a single 4 ohms speaker is connected to either the #1 or #2 output, the amplifier will deliver up to 70 watts continuous average (RMS) power. When a single 8 ohms speaker is connected to either the #1 or #2 output, the amplifier will deliver up to 45 watts continuous power. If using a pair of 8 or 16 ohms speakers, connect one each to the #1 and #2 outputs. We recommend using 18 gauge "zip cord" or even heavier wire; strip 1/3" of insulation, twist the strands, press in the tab on the speaker output terminal, insert the bared wire in the center hole, and release the tab.

CAUTIONS

1. Do not connect more than one 4 ohms speaker to the mixer since the amplifier will be overloaded.
2. Never plug the speaker output into anything but a speaker load or a direct box made for high power levels, and never patch an output directly back to an input unless directed to do so by this manual.

BRIEF OPERATING INSTRUCTIONS

④ Line Output

This unbalanced 1/4" (6.3 mm) tip/sleeve phone jack carries the mixed signal from all the input channels, including the auxiliary input, and from the delay line. The level is controlled by the Master volume control, and is nominally 0 dB. This jack is designed to medium to high impedance inputs, such as other mixers, power amplifiers, or tape recorders.

⑤ Record Outputs

This pair of RCA-type pin jacks (phono jacks) both carry the same signal, which differs from the Line output in that it is not affected by the Master volume control.

Record Out has a nominal level of -3 dB, and is designed to feed high impedance line inputs such as tape recorders or power amplifiers which have their own volume controls. Use one jack to feed single-channel equipment, or both jacks to feed dual-channel equipment (or two different pieces of single-channel equipment).

⑥ Auxiliary Inputs 1 & 2

Aux In 1 is an unbalanced 1/4" (6.3 mm) tip/sleeve phone jack intended for connection of the output of another mixer or tape recorder. Alternately, it can serve as a spare input for a preamplified instrument such as a synthesizer. This jack is "live" only when the front panel Aux input selector switch is set to "Aux 1" position.

Aux In 2 is a pair of parallel-wired RCA-type pin jacks intended for connection of the output from a tape recorder, FM tuner, a stereo high fidelity system, and so forth. Use one jack for mono sources and both jacks for stereo sources (which are then mixed internally to mono). These jacks are "live" only when the front panel Aux input selector switch is set to "Aux 2" position.

Both the Aux 1 and Aux 2 inputs have nominal -20 dB sensitivity, and are intended for use with low or high impedance outputs.

⑦ Phono Input

This input is a pair of RCA-type pin jacks that are intended for direct connection of a magnetic phonograph cartridge. The jacks are mixed internally, via isolation resistors, to mono, and feed a built-in RIAA preamplifier. Thus, the Phono Input is suitable for inputs from mono or stereo cartridges, but should not be used with a microphone or other source. The Phono input is "live" only when the front panel Aux input selector switch is set to "Phono" position. Nominal sensitivity is -50 dB, with an actual input impedance of 47 kohms.

NOTE: Even if only one of the two Phono inputs is used, both of the supplied shorting plugs should be removed.

A ground post is located above the input jacks, and should be used to ground the phonograph chassis to the mixer chassis to reduce hum. Unscrew the knurled sleeve, and slide a stripped end of the ground wire through the hole in the center post. The other end of the wire should be connected to the phonograph chassis.

GETTING THE MOST FROM THE BUILT-IN ANALOG DELAY LINE

WHAT IS AN ANALOG DELAY LINE ?

An analog delay line is an electronic circuit that provides echo and related effects by slowing down audio signals---a more capable space-age alternative to older style tape-loop echo machines and reverb springs. The term "analog" means that the audio signal retains its original voltage levels throughout the electronics. Since there are no moving parts in the delay, maintenance is unnecessary. Moreover, the normal shocks or vibration encountered in touring and in high sound level environments do not affect the sound.

ECHO AND REVERB EFFECTS ?

"Echo" and "reverb" are often confused with one another, and there is some overlap in their definitions. Generally speaking, "echo" consists of one or more distinct, delayed sound images with recognizable attacks. "Reverb" also consists of multiple delayed sound images, but they smear together and have no discretely discernable attacks.

To get a single echo from the delay line, set the Feedback control at zero, and adjust the time delay as desired. For multiple echoes, turn up the Feedback control. If the input program has little or no sharp musical attacks (i.e., legato string lines or melodic vocal backups), then the multiple echoes with a long delay time can sound like a reverb. When there are more sharp attacks and decays in the program material, the effect will be more repetitive.

MANUAL PITCH BEND WITH FEEDBACK ?

It is possible to obtain changes in pitch (frequency) by using the delay line! Simply set the Feedback at about #5, and vary the Delay Time up and down between #0 and #10, or anywhere on the scale. If you move the Delay control up or down and then hold it at the new setting, the pitch will increase or decrease, then stay constant until the delay dies out or a new sound is introduced.

SETTING UP

Before turning on the mixer's AC power switch, connect all inputs, outputs and speakers, and be sure the Feedback control is at #0. If other electronic equipment or electronic instruments are connected to the EM-85's inputs, turn on that equipment before turning on the mixer. This will not only avoid annoying hum, it will help prevent turn-on transients from damaging speakers or other equipment.

Set the input Line/Inst/Mic selector switches to complement the type of device that is plugged into the Input Jack below. Set the Aux 1/Aux 2/Phono selector to whichever of these three rear-panel inputs is in use (if none is to be used, the switch setting should be Aux 1, and the Aux Volume control set at minimum).

CAUTION

Do not connect the speaker output of any amplifier to the mixer unless a suitable high-level attenuation pad or "direct box" first drops the level.

FIG. 3. ECHO/REVERB DELAY CONTROL SETTINGS.

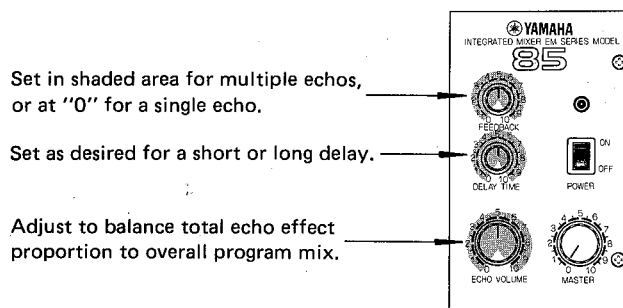
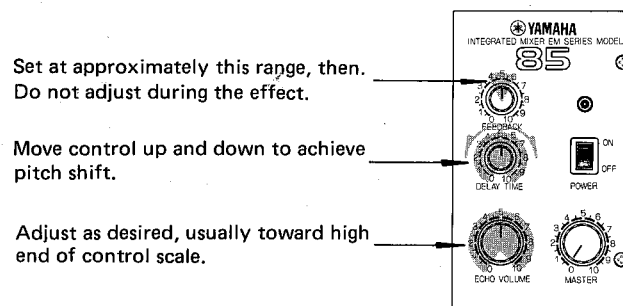

FIG. 4. PITCH BEND DELAY CONTROL SETTINGS



If runaway Feedback (Howling) should occur, immediately turn down the EM-85 Feedback control.

Initially, set the channel Volume controls at #0, and the Master volume control at about #3. Turn all channel Echo controls and master Echo Volume to #0, and center the Bass and Treble controls. One channel at a time, bring up the Volume controls (including Aux Volume if the Aux or Phono input is in use) until the desired mix balance is achieved; these volume controls should be set somewhere between #5 and #8. Then, if the overall volume is too low or too high, readjust the Master volume accordingly. Once the overall volume and balance are thus set, adjust the Bass and Treble controls as desired.

If you want to add echo effects to one or more channels, first set the master Echo Volume control at about #5. Then set the channel Echo controls to between #0 and #10, depending on how much effect you want each channel to contribute. Now experiment with the delay time and feedback controls to achieve the effect quality you want. (See FIG. 3 and 4, and the associated descriptions for suggested starting points to achieve various effects). Finally, readjust the Echo Volume control as required.

APPLICATIONS

FIG. 5. USING THE EM-85 FOR A VOCAL SOUND REINFORCEMENT SYSTEM.

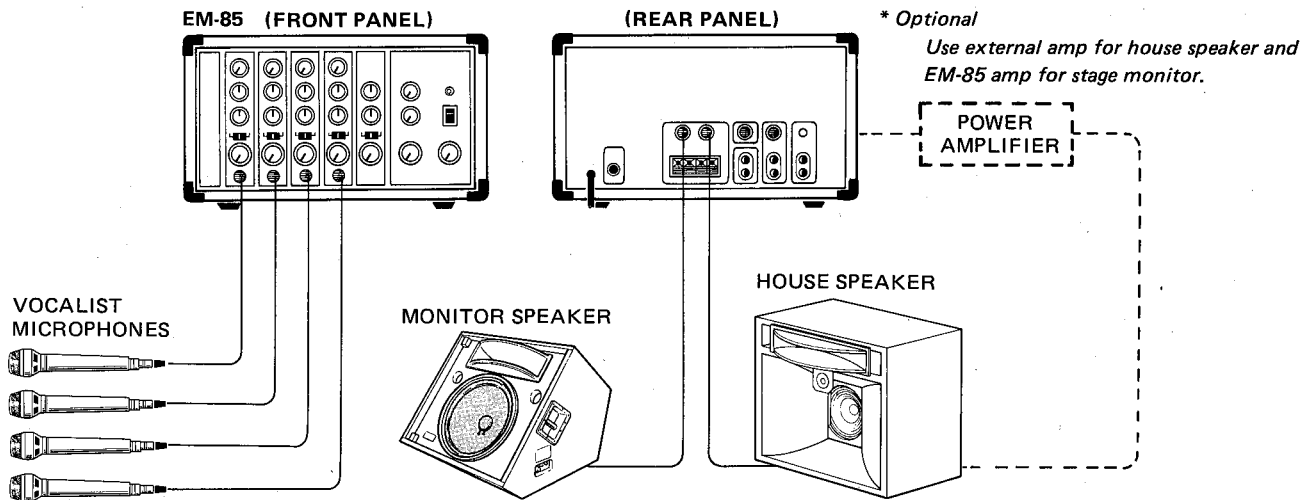

FIG. 6. USING THE EM-85 FOR A SOLO PERFORMER SOUND REINFORCEMENT SYSTEM.

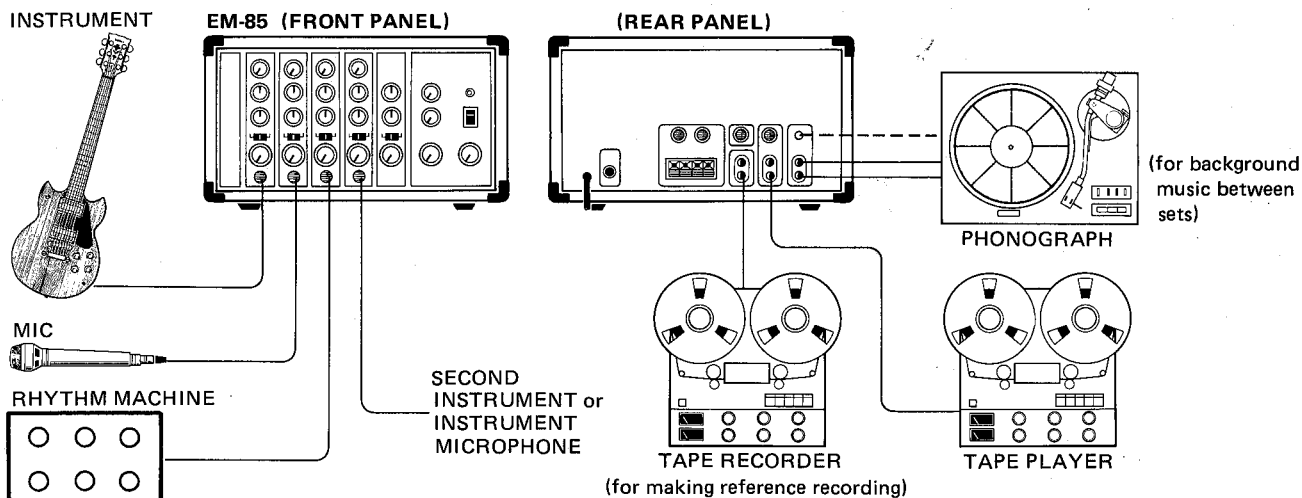
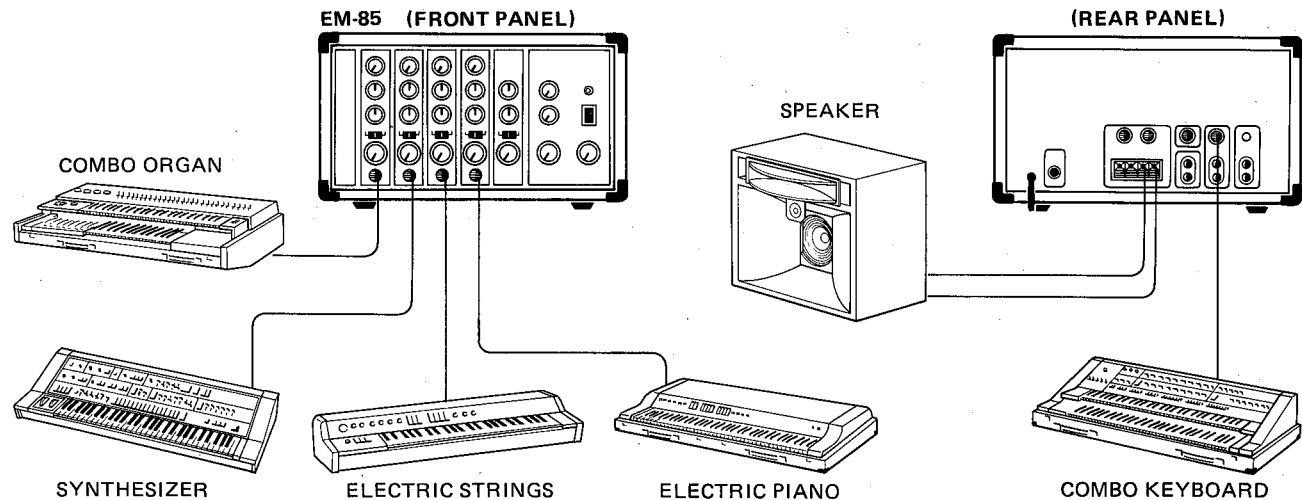

FIG. 7. USING THE EM-85 FOR A KEYBOARD SOUND REINFORCEMENT SYSTEM.



The Aux 1 input can be used as a fifth input channel to accommodate a high level synthesizer output.

FIG. 8. USING THE EM-85 FOR AN INSTITUTIONAL PUBLIC ADDRESS SYSTEM.

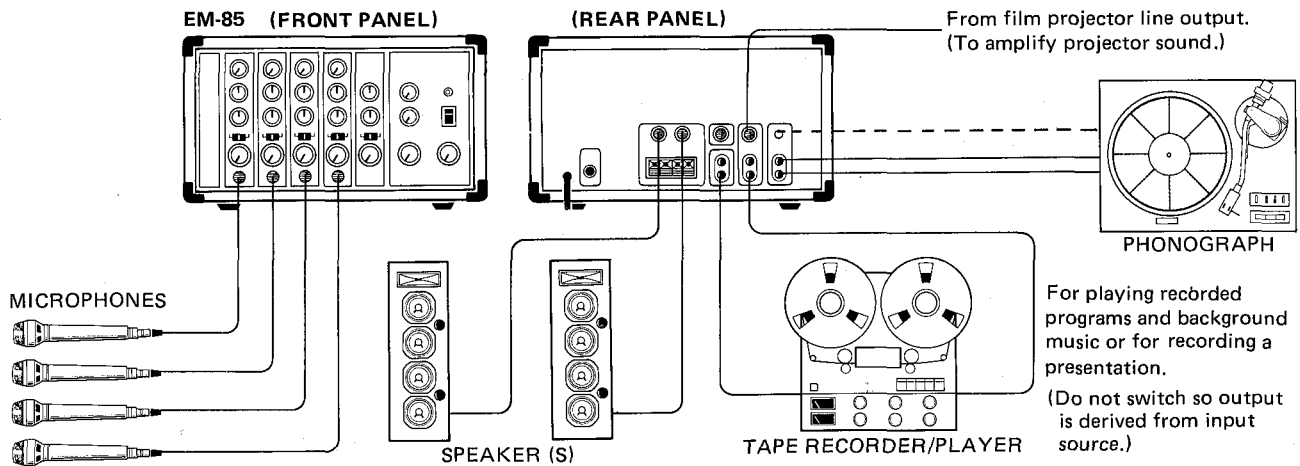
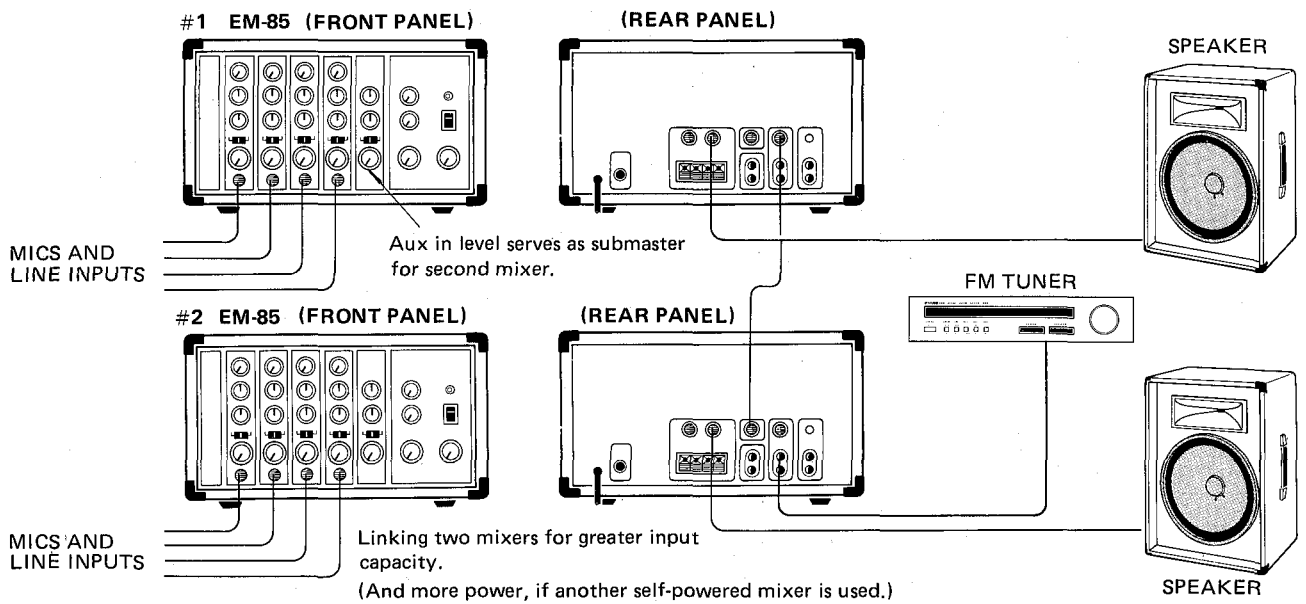

FIG. 9. EXPANDING THE NUMBER OF MIXING CHANNELS.



If you need more than four line/inst/mic input channels, you can use another mixer in conjunction with the EM-85. The second mixer need not have a built-in power amplifier. Simply connect the line-level output of the second mixer to the EM-85 Aux 1 or Aux 2 input, depending on which type of jacks match the mating cable, and set the EM-85 Aux input selector accordingly. The EM-85 Aux Volume control then serves as a sub master for all the channels on the second mixer. In any of the previously described applications, it may be desirable to connect a phono graph or tape machine to the

sound system for providing background music between live performances, or for setup purposes. The tape recorder (or an FM tuner) can be connected to Aux In 1 or 2, and the phono graph to the Phono Input. Sometimes it is desirable to make a reference tape recording of the live event. The EM-85's Record Out jacks are ideal for feeding a mono or stereo cassette recorder, or a reel-to-reel recorder. Any adjustments in the Master Volume, which are intended for sound level changes in the room, will not affect the optimum record level, which is adjusted at the recorder input.

BLOCK DIAGRAM

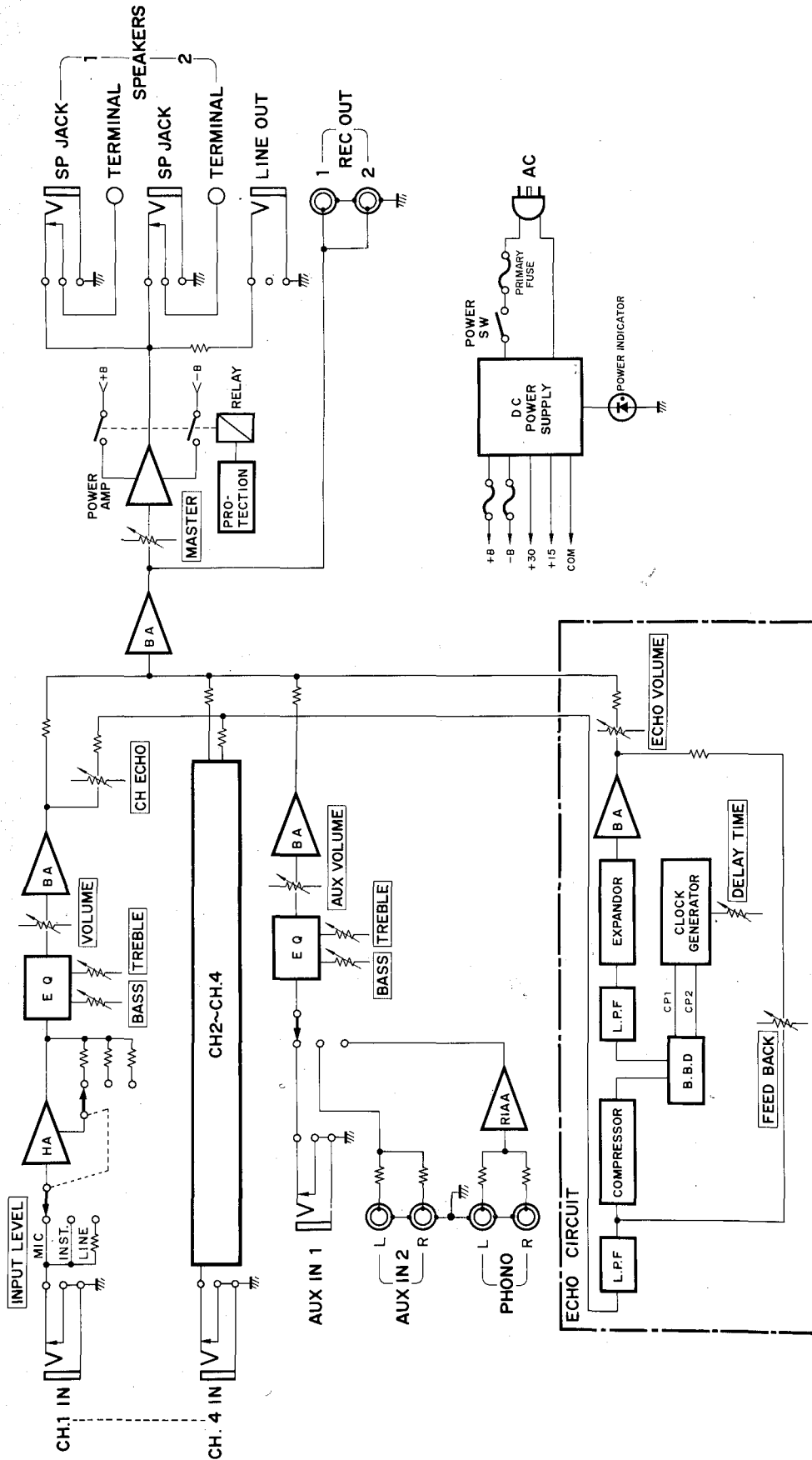



SERVICE

The EM-85 mixer is supported by Yamaha's worldwide network of factory trained and qualified dealer service personnel. In the event of a problem, contact your nearest Yamaha dealer.